



US00D732841S

(12) **United States Design Patent**  
**Garcia**

(10) **Patent No.:** **US D732,841 S**  
(45) **Date of Patent:** **\*\* Jun. 30, 2015**

- (54) **CHAIR**
- (71) Applicant: **Baker, Knapp & Tubbs, Inc.**, Hickory, NC (US)
- (72) Inventor: **Jacques Garcia**, Paris (FR)
- (73) Assignee: **BAKER, KNAPP & TUBBS, INC.**, Hickory, NC (US)
- (\*\*) Term: **14 Years**
- (21) Appl. No.: **29/468,458**
- (22) Filed: **Sep. 30, 2013**
- (51) **LOC (10) Cl.** ..... **06-01**
- (52) **U.S. Cl.**  
USPC ..... **D6/334**
- (58) **Field of Classification Search**  
USPC ..... D6/334, 335, 336, 381, 377, 361, 375;  
297/94, 118, 188.01, 445.1, 448.1,  
297/452.11, DIG. 7, DIG. 8  
CPC ..... A47C 17/00; A47C 17/02; A47C 17/12;  
A47C 17/18; A47C 7/021; A47C 31/00;  
A47C 3/16  
See application file for complete search history.

D596,869 S *	7/2009	Massaud .....	D6/369
D610,844 S *	3/2010	Muller .....	D6/502
D690,950 S *	10/2013	Lievore et al. ....	D6/375
D690,975 S *	10/2013	Lievore et al. ....	D6/716

\* cited by examiner

*Primary Examiner* — Sandra Snapp  
(74) *Attorney, Agent, or Firm* — Foley & Lardner LLP

(57) **CLAIM**  
I claim the ornamental design for a chair, as shown and described.

**DESCRIPTION**

FIG. 1 is a perspective view of an exemplary embodiment of the claimed design;  
 FIG. 2 is a front view of the claimed design shown in FIG. 1;  
 FIG. 3 is a side view of the embodiment shown in FIG. 1;  
 FIG. 4 is a rear side view of the embodiment shown in FIG. 1;  
 FIG. 5 is another side view of the embodiment shown in FIG. 1;  
 FIG. 6 is a top view of the embodiment shown in FIG. 1;  
 FIG. 7 is a bottom view of the embodiment shown in FIG. 1;  
 FIG. 8 is a perspective view of another exemplary embodiment of the claimed design;  
 FIG. 9 is a front view of the claimed design shown in FIG. 8;  
 FIG. 10 is a side view of the embodiment shown in FIG. 8;  
 FIG. 11 is a rear side view of the embodiment shown in FIG. 8;  
 FIG. 12 is another side view of the embodiment shown in FIG. 8;  
 FIG. 13 is a top view of the embodiment shown in FIG. 8; and,  
 FIG. 14 is a bottom view of the embodiment shown in FIG. 8.  
 The broken lines shown in the drawings are for illustrative purposes only and form no part of the claimed design.

- (56) **References Cited**  
U.S. PATENT DOCUMENTS
- |              |         |                      |        |
|--------------|---------|----------------------|--------|
| D334,296 S * | 3/1993  | Hutton .....         | D6/374 |
| D395,758 S * | 7/1998  | Hutton .....         | D6/334 |
| D427,786 S * | 7/2000  | Vu .....             | D6/334 |
| D430,740 S * | 9/2000  | Chun .....           | D6/334 |
| D478,430 S * | 8/2003  | Olson .....          | D6/380 |
| D498,069 S * | 11/2004 | Kreiss .....         | D6/369 |
| D504,580 S * | 5/2005  | Kreiss .....         | D6/380 |
| D549,477 S * | 8/2007  | Bryant et al. ....   | D6/369 |
| D562,581 S * | 2/2008  | Marin et al. ....    | D6/369 |
| D574,161 S * | 8/2008  | Sneujink et al. .... | D6/379 |

**1 Claim, 14 Drawing Sheets**

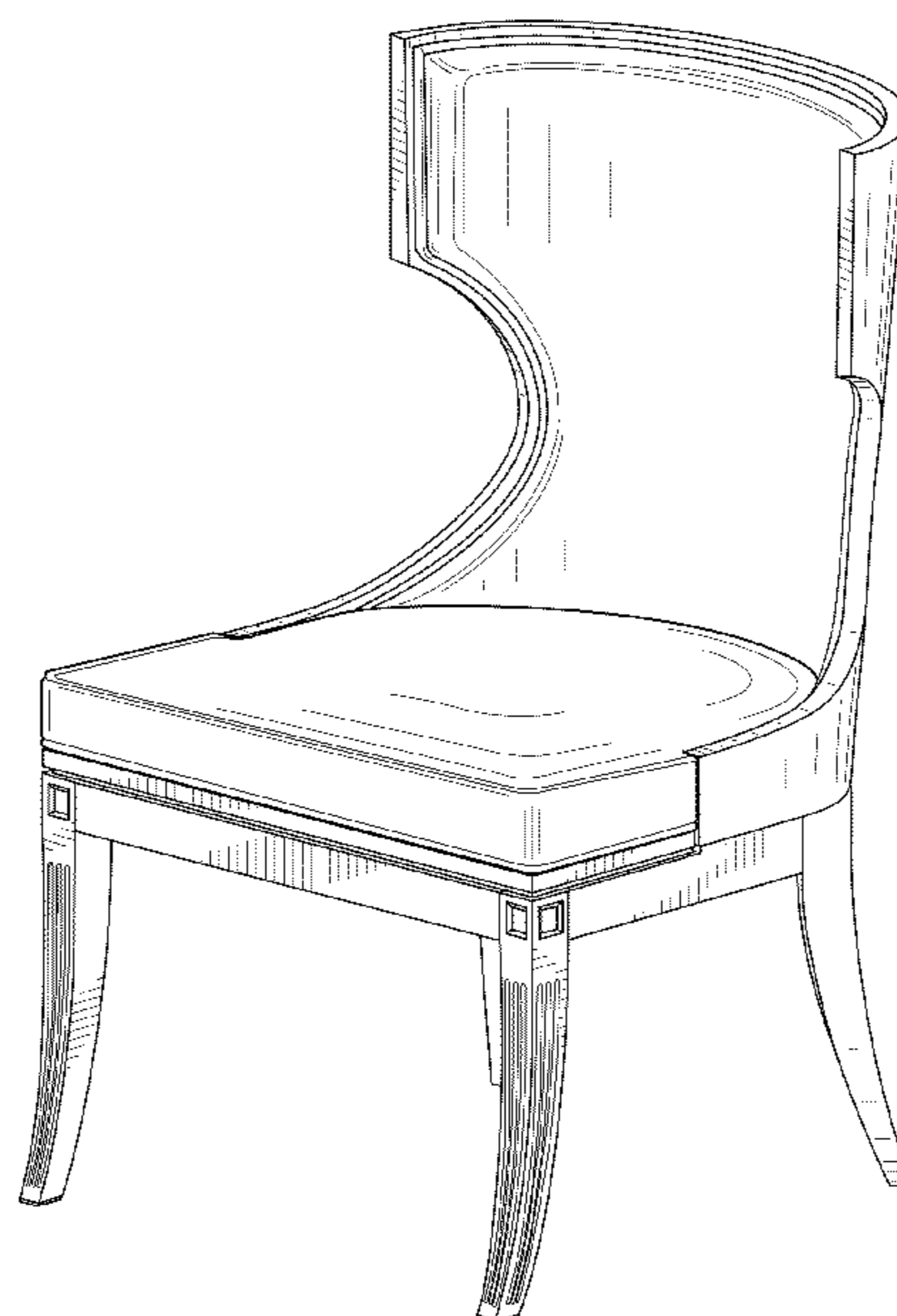

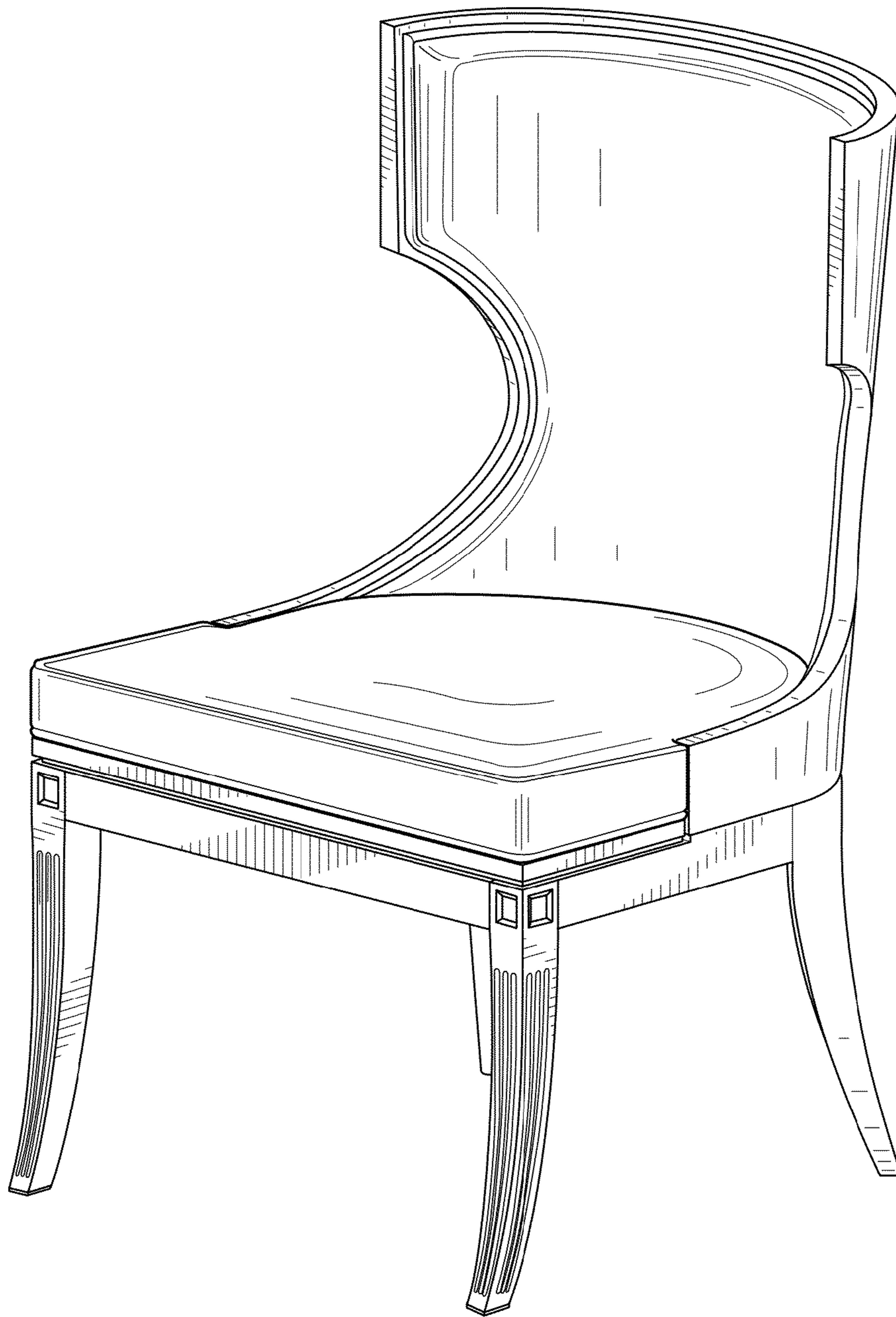

**FIG. 1**

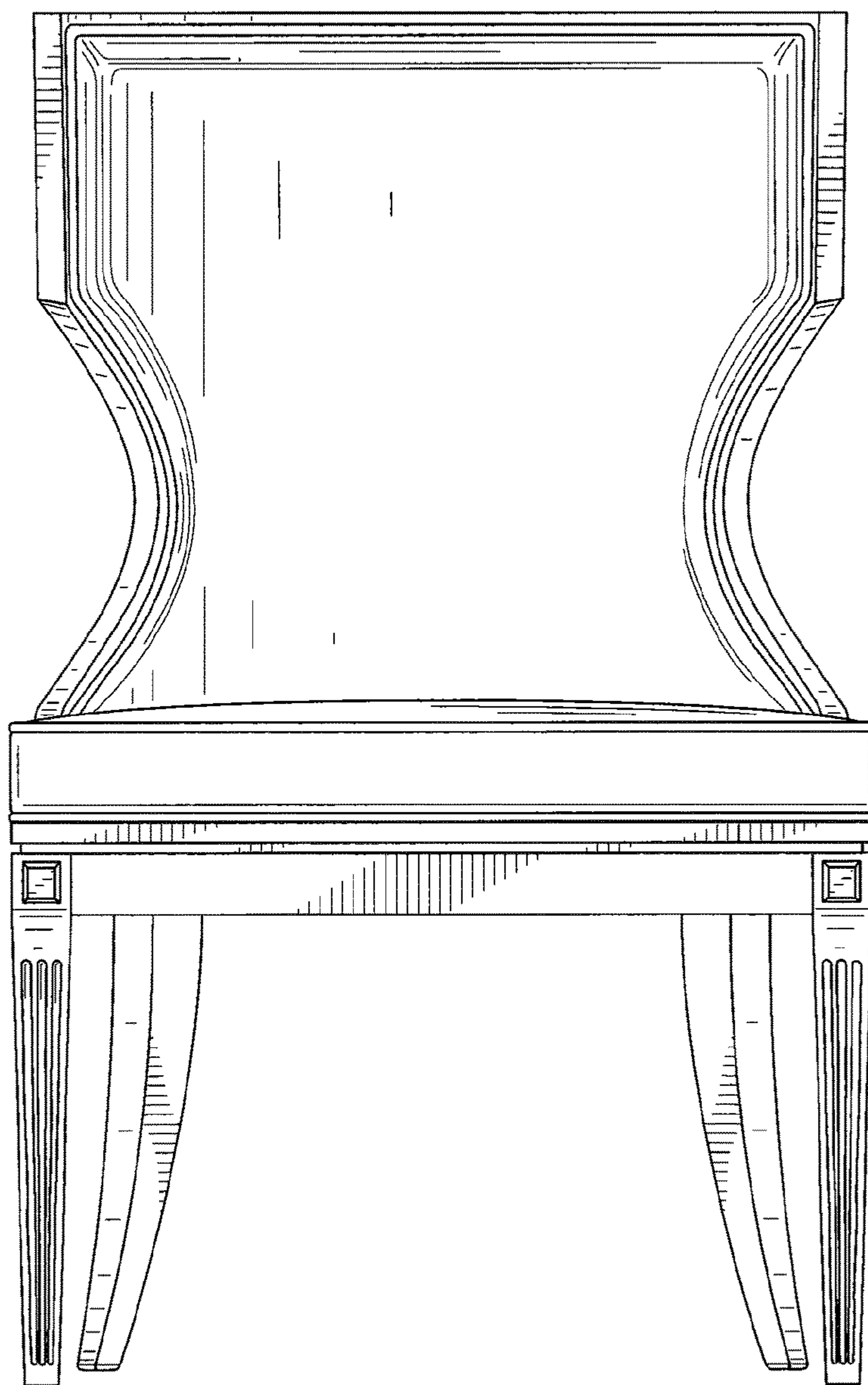
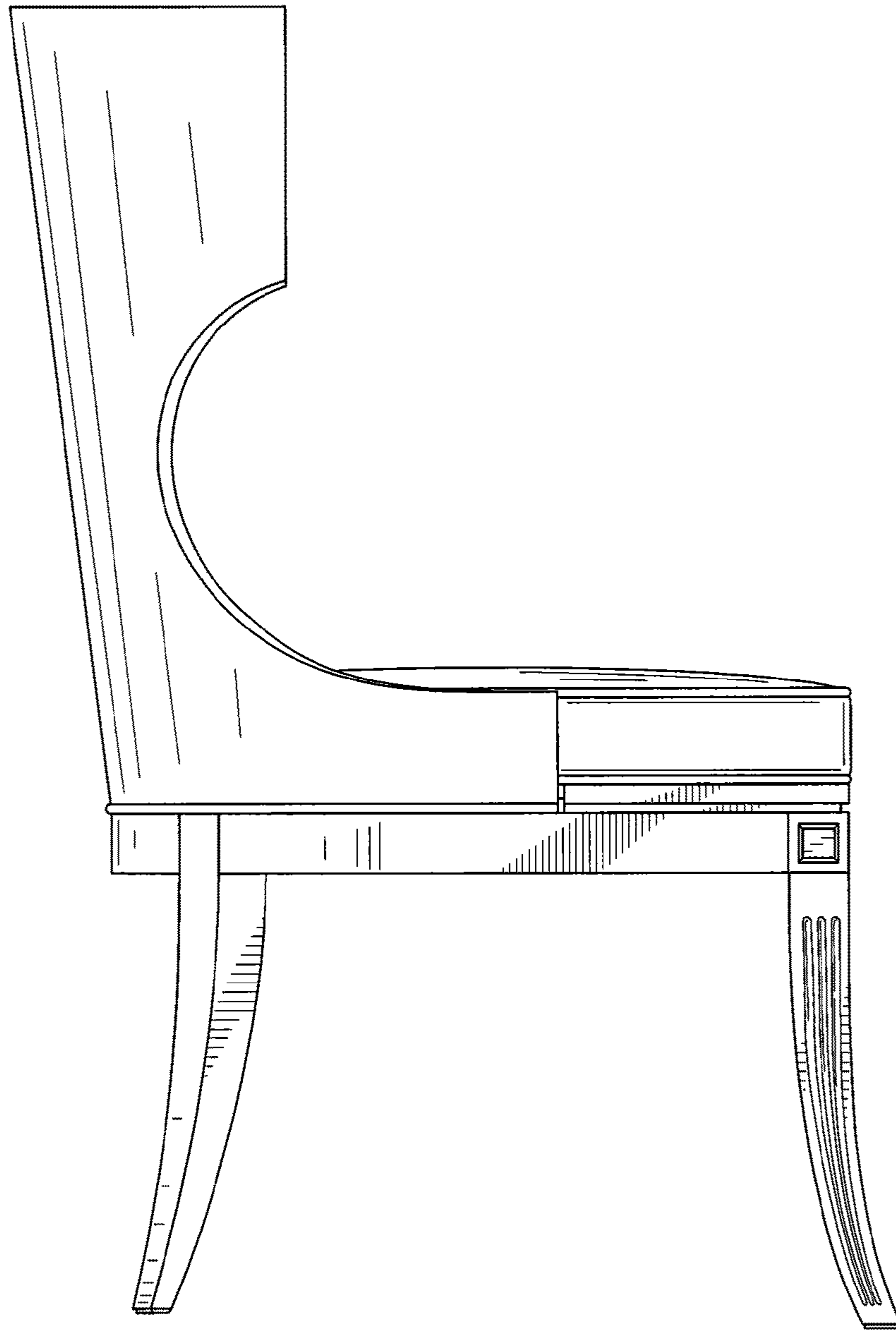

FIG. 2



**FIG. 3**

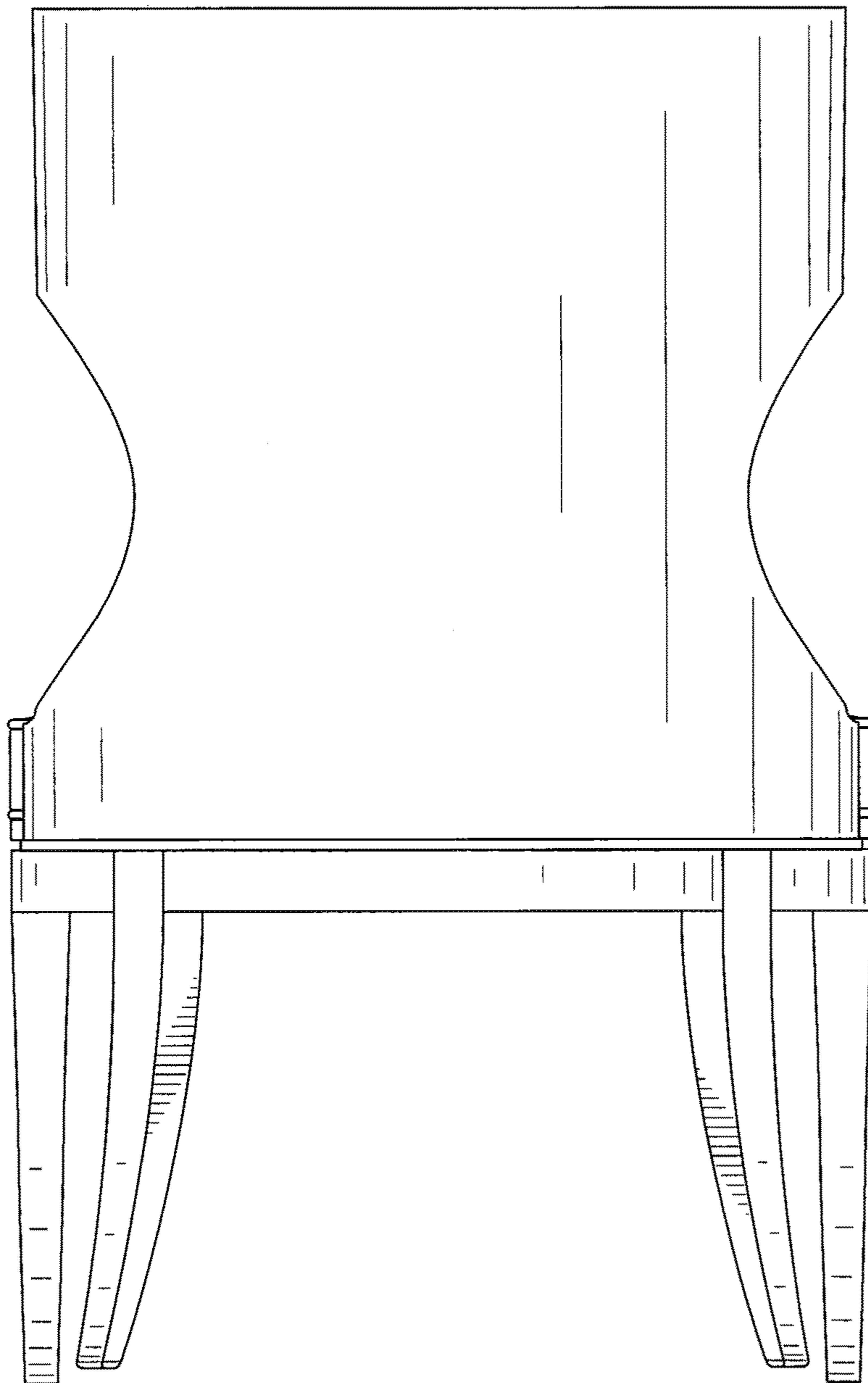

FIG. 4

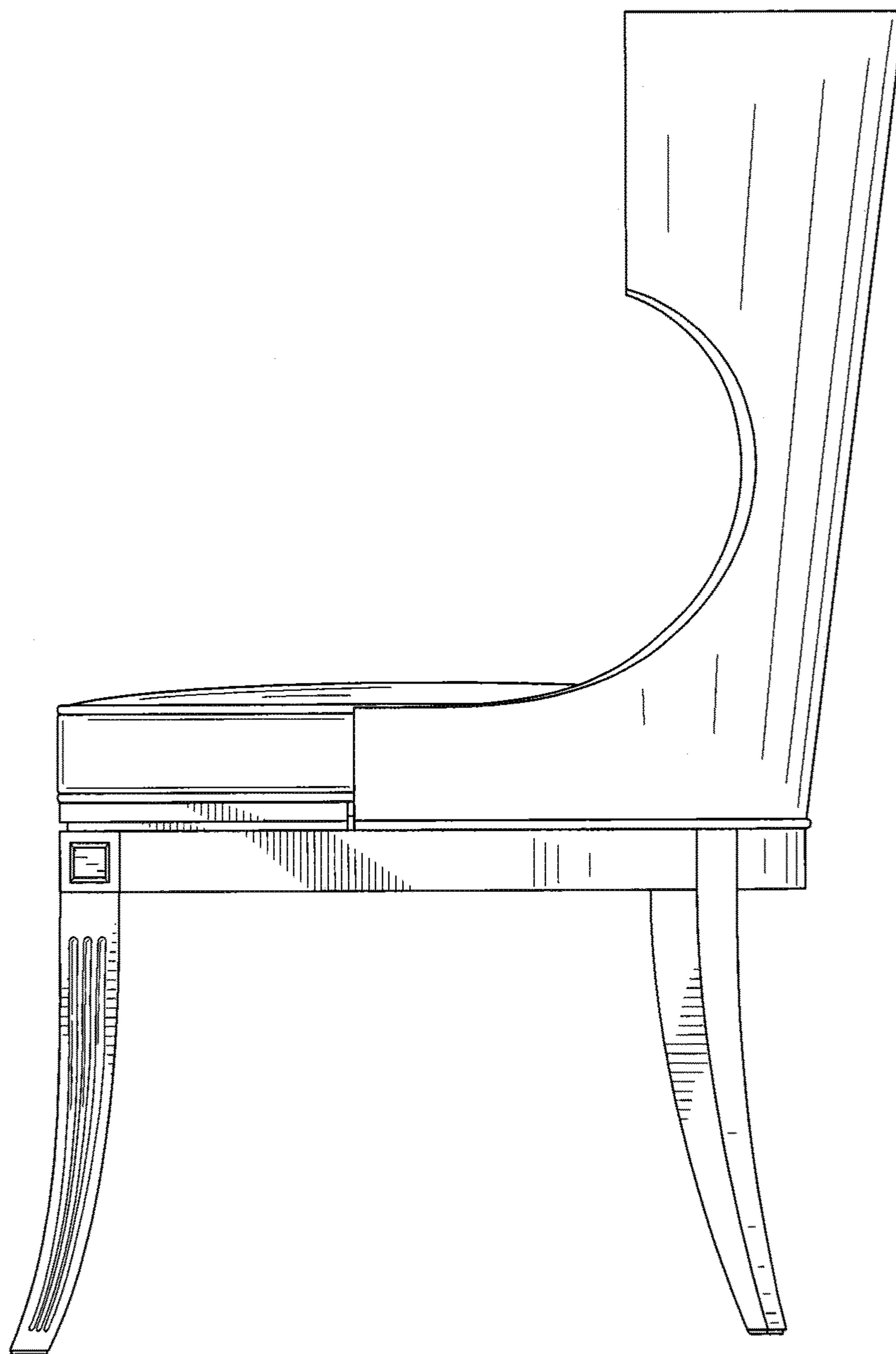
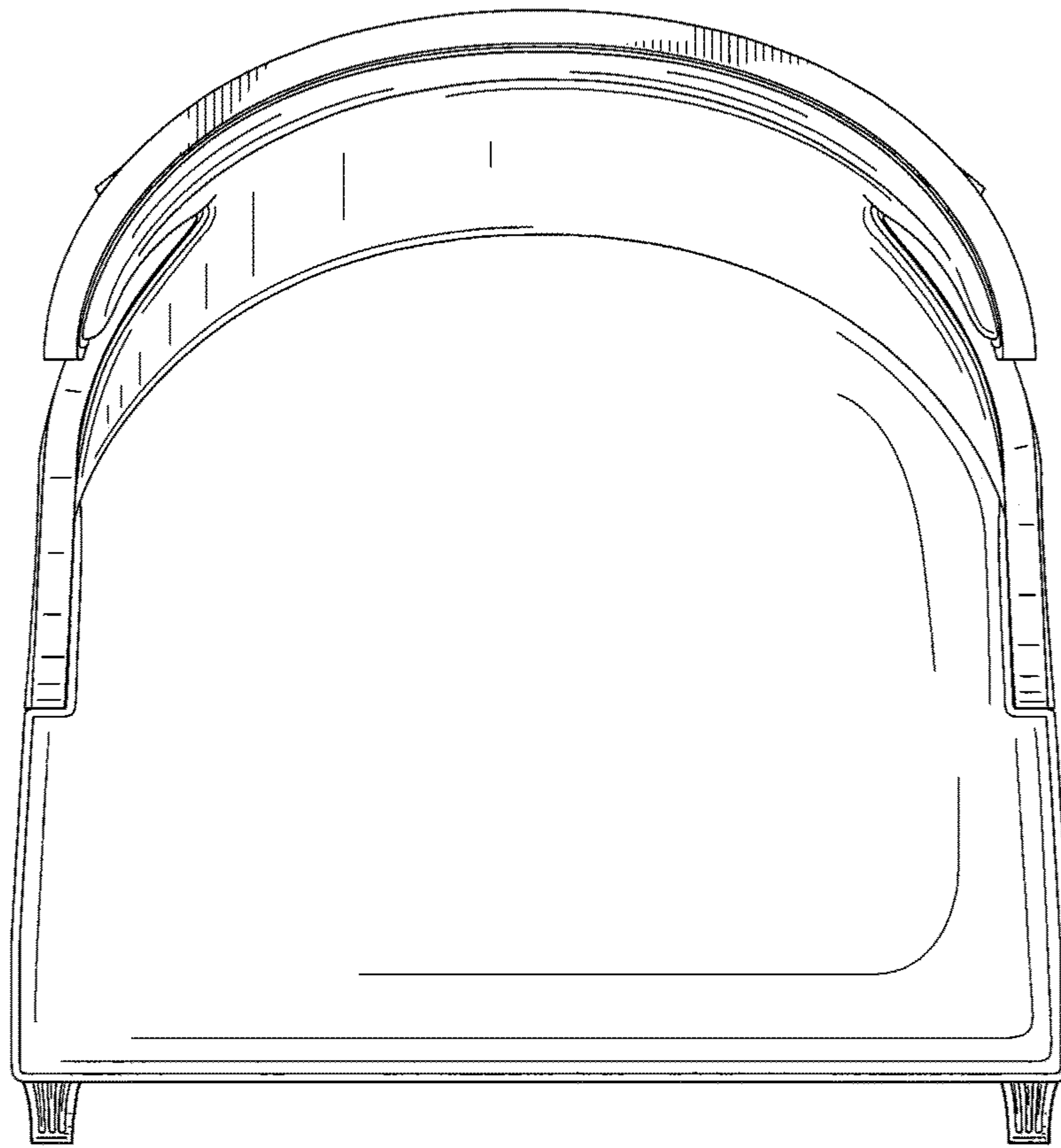

FIG. 5



**FIG. 6**

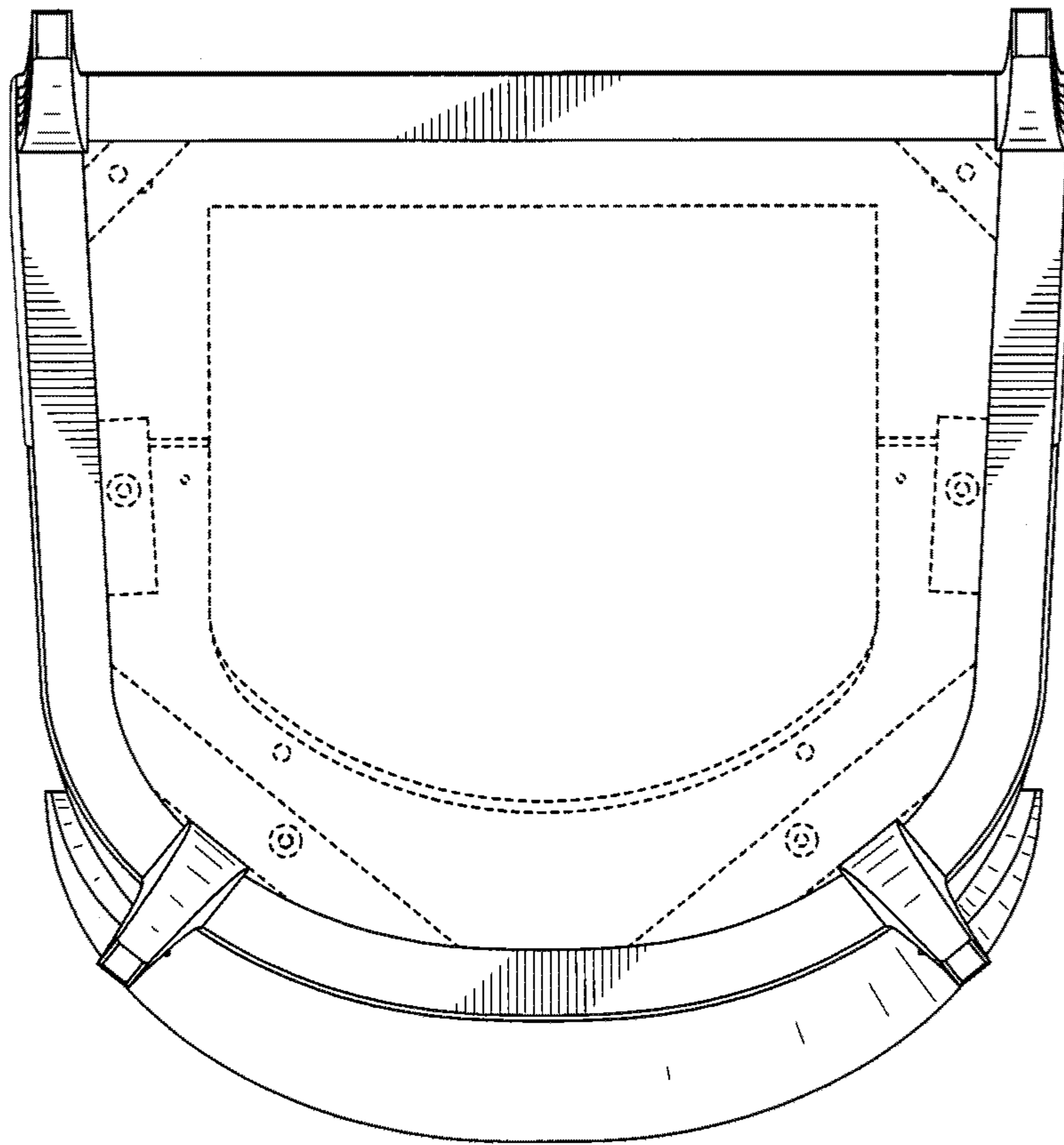
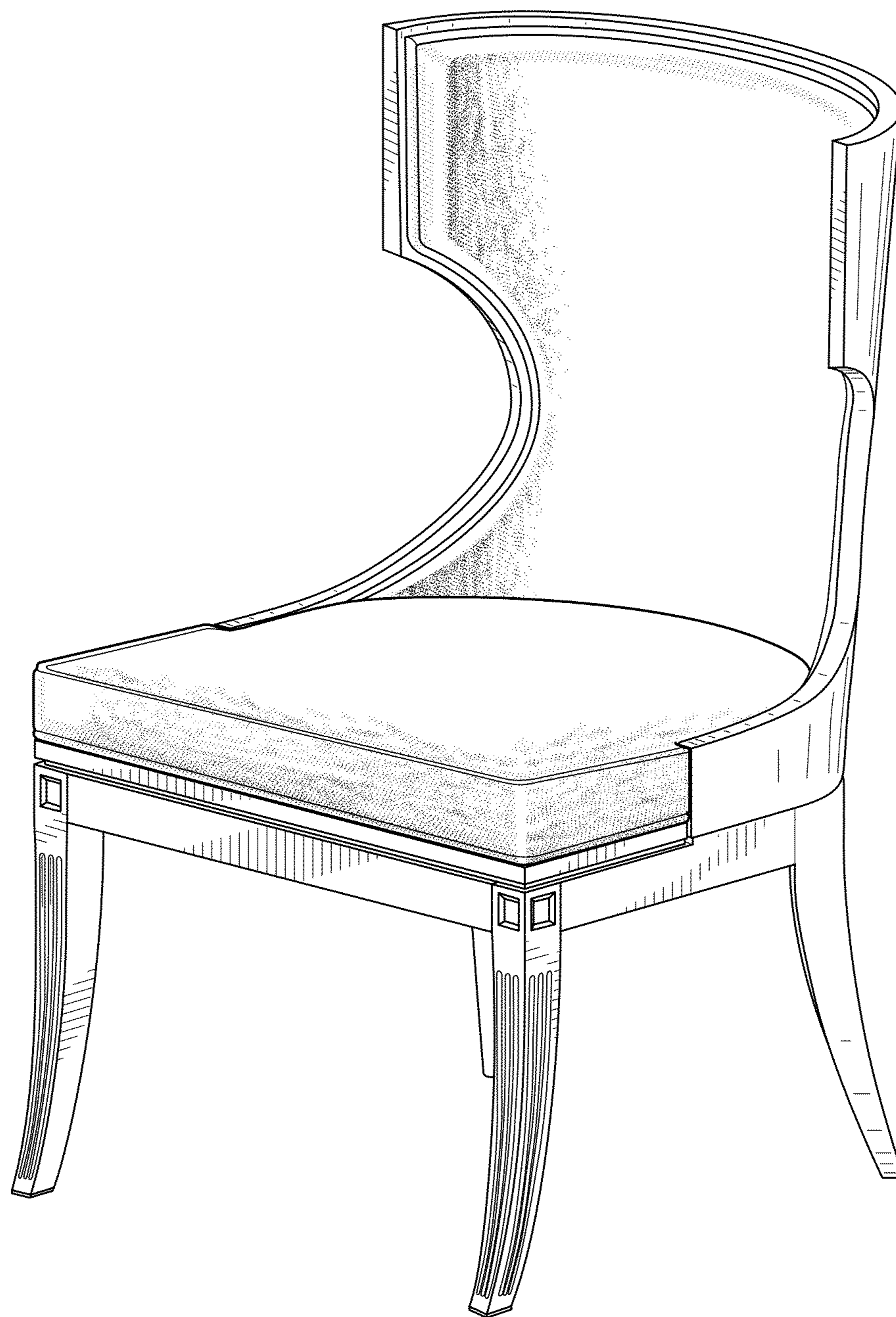

FIG. 7





**FIG. 8**

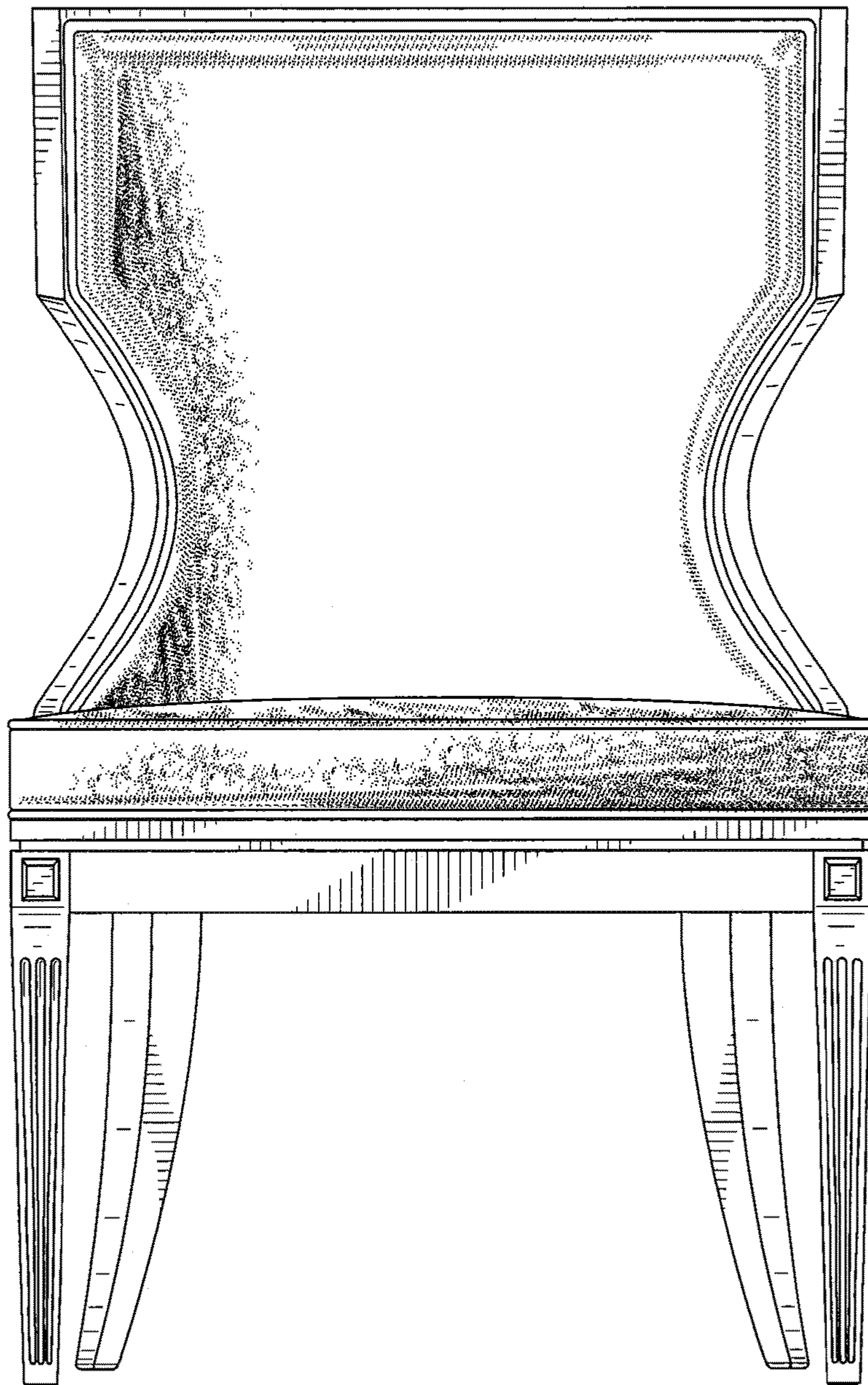
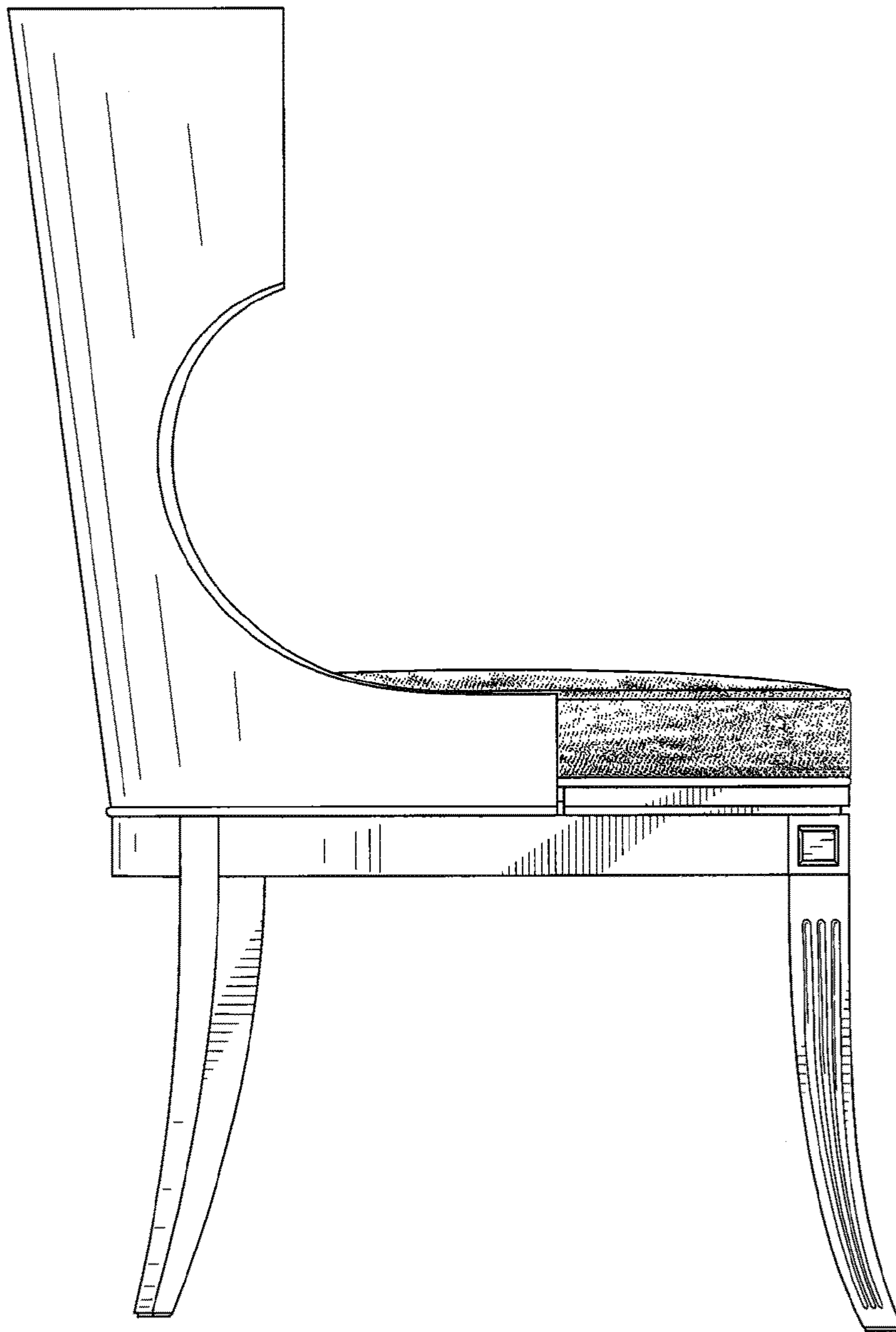
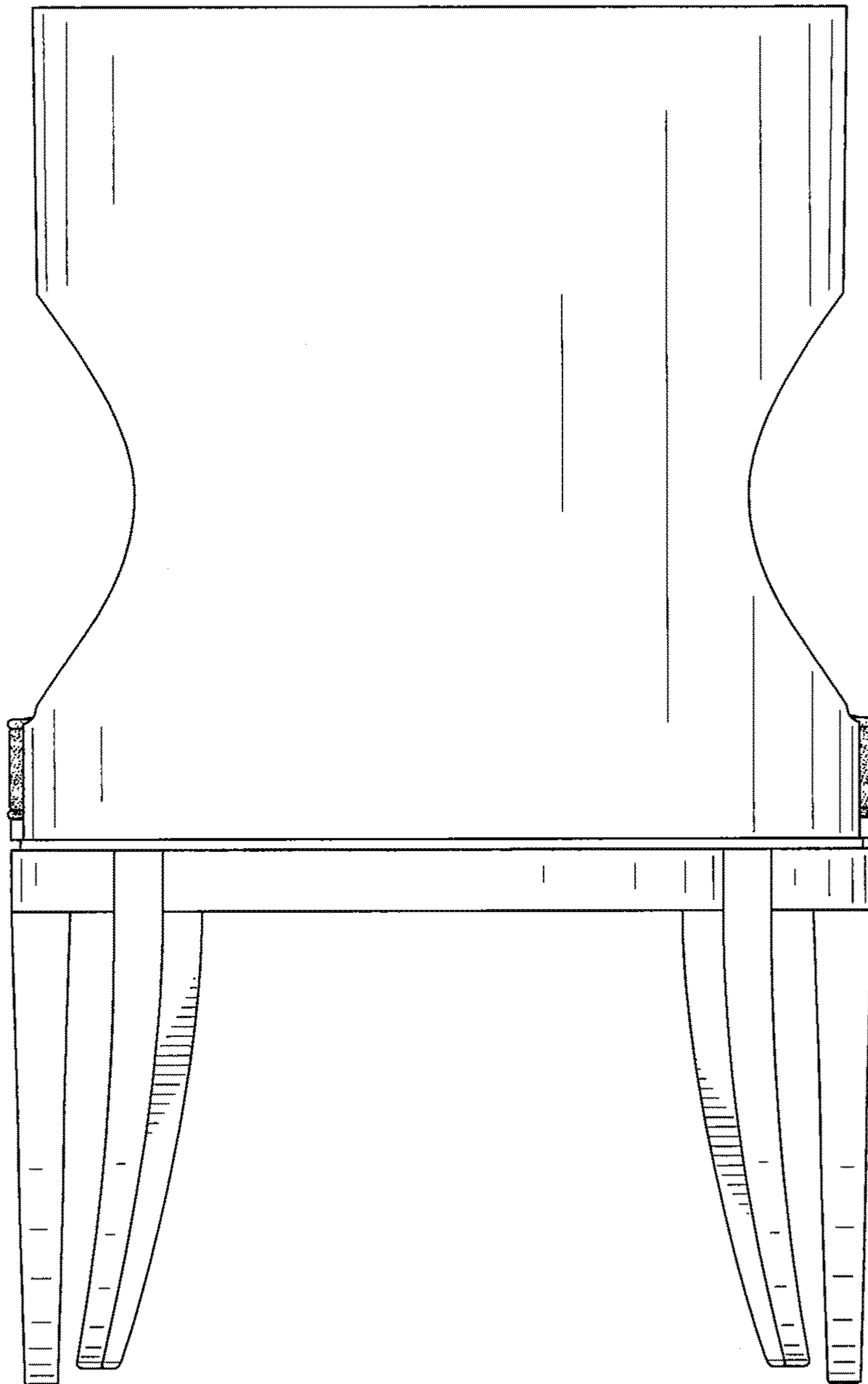

FIG. 9



**FIG. 10**



**FIG. 11**

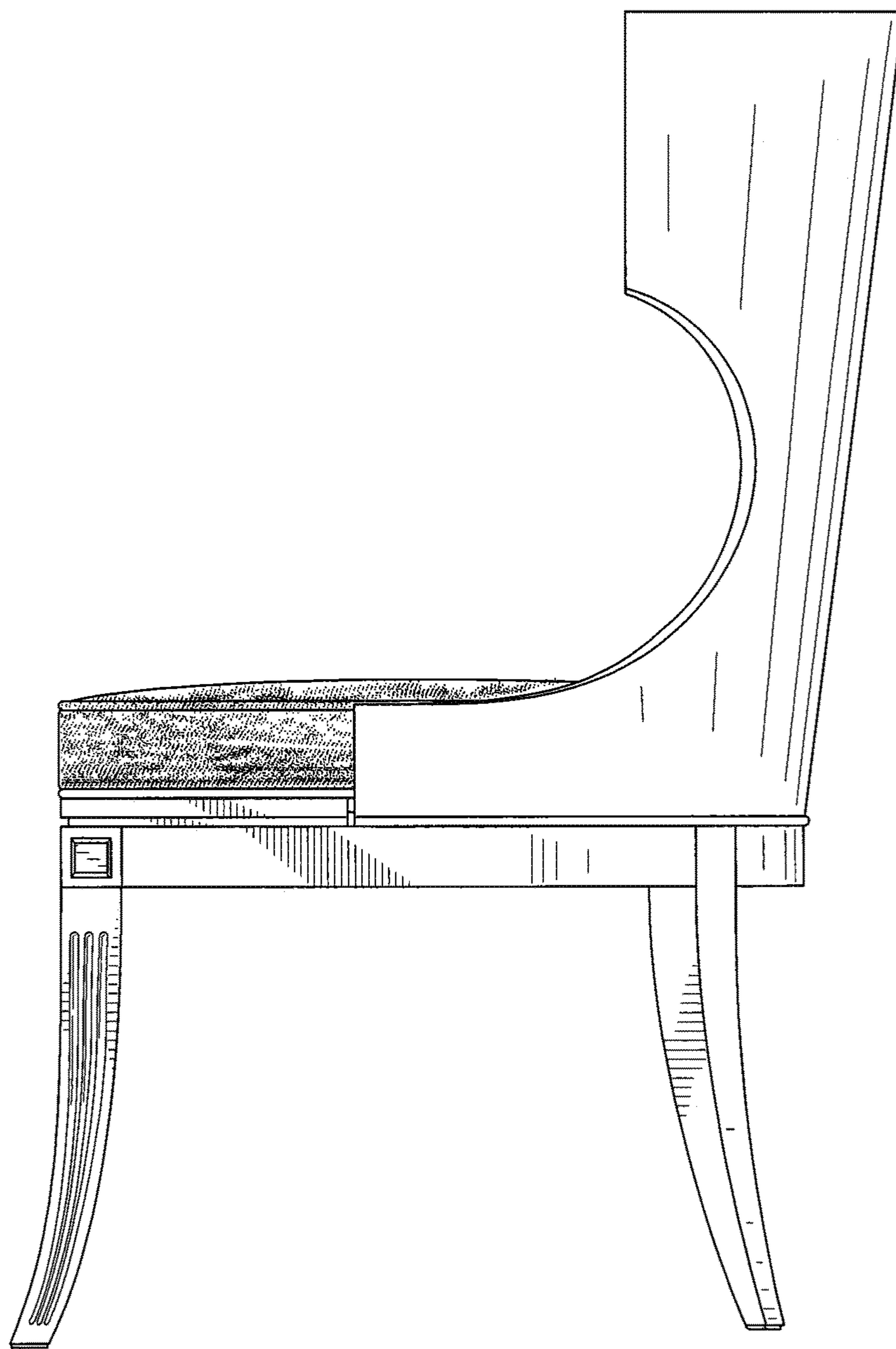

**FIG. 12**

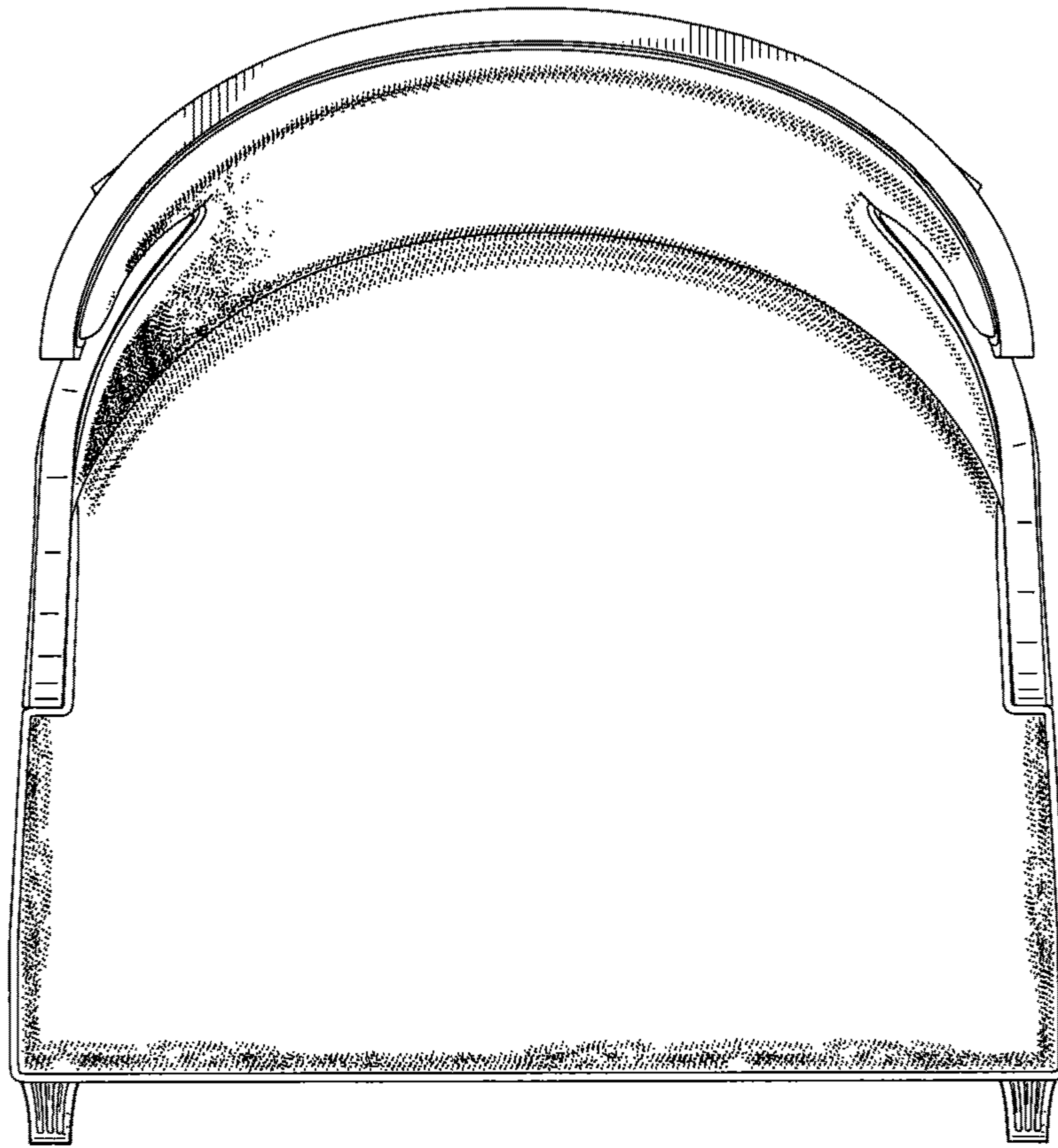

**FIG. 13**

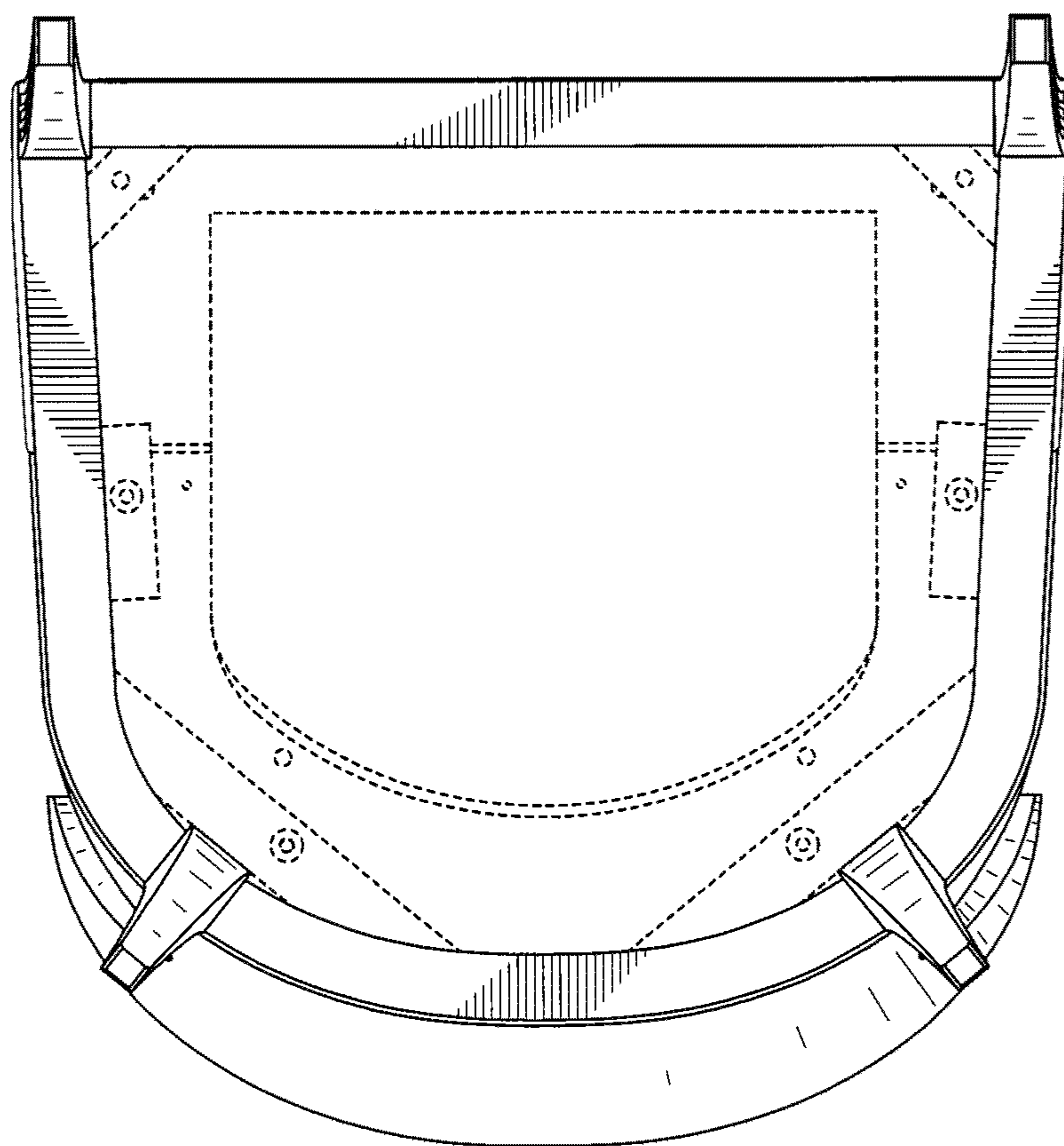

FIG. 14