

US00D732818S

(12) **United States Design Patent**
Pineda

(10) **Patent No.:** **US D732,818 S**
(45) **Date of Patent:** **** Jun. 30, 2015**

(54) **GO SLEEVE-ARM/LEG BAND**

Primary Examiner — Catheri Oliver-Garcia

(76) Inventor: **Renan R Pineda**, North Plainfield, NJ
(US)

(**) Term: **14 Years**

(21) Appl. No.: **29/405,299**

(22) Filed: **Oct. 31, 2011**

(51) **LOC (10) Cl.** **03-01**

(52) **U.S. Cl.**
USPC **D3/215**

(58) **Field of Classification Search**
USPC D3/215, 224, 226, 228, 230; 224/219,
224/222, 267, 269; 2/162, 170
See application file for complete search history.

(56) **References Cited**

U.S. PATENT DOCUMENTS

4,905,881	A	*	3/1990	Graber	224/222
D340,805	S	*	11/1993	Bates et al.	D3/230
D358,705	S	*	5/1995	Saggese, Jr.	D3/226
D371,675	S	*	7/1996	Carter	D3/215
D391,075	S	*	2/1998	Jackson et al.	D3/215
D507,103	S	*	7/2005	Charles, Jr.	D3/215
D512,832	S	*	12/2005	Charles, Jr.	D3/215
D515,805	S	*	2/2006	Jones	D3/215

* cited by examiner

(57) **CLAIM**

The ornamental design for the go sleeve-arm/leg band, as shown and described.

DESCRIPTION

FIG. 1 is a front elevation view of a first embodiment of the go sleeve-arm/leg band with pockets, showing my new design in an open and flat position;
FIG. 2 is a front elevation view, with the design shown in a closed position;
FIG. 3 is a rear elevation view, thereof;
FIG. 4 is a front perspective view of the design;
FIG. 5 is a rear perspective view thereof;
FIG. 6 is a front elevation view of a second embodiment of the go sleeve-arm/leg band with pockets, showing my new design in an open and flat position;
FIG. 7 is a front elevation view, with the design shown in a closed position;
FIG. 8 is a rear elevation view, thereof;
FIG. 9 is front perspective view of the design; and,
FIG. 10 is a rear perspective view.

1 Claim, 4 Drawing Sheets

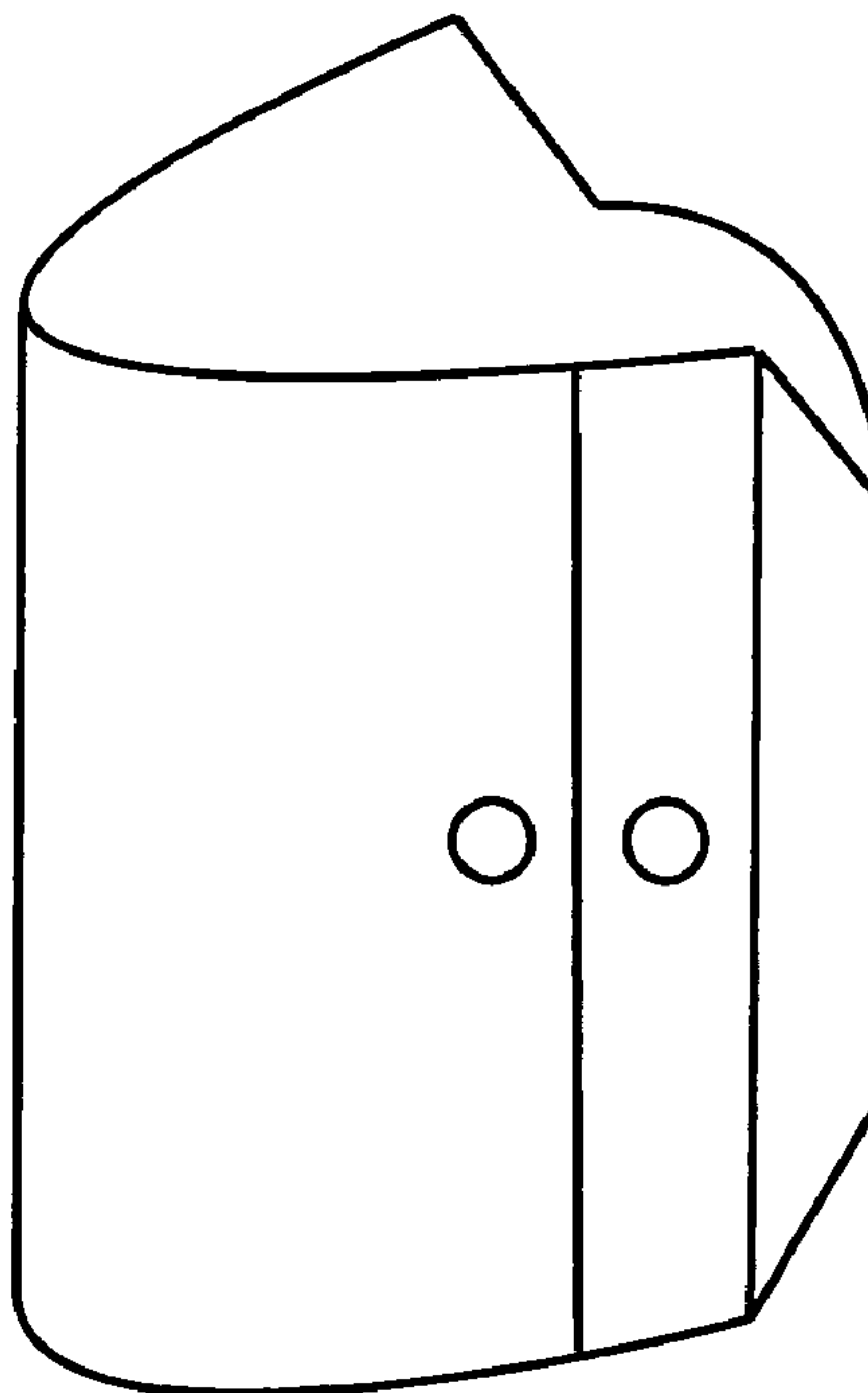

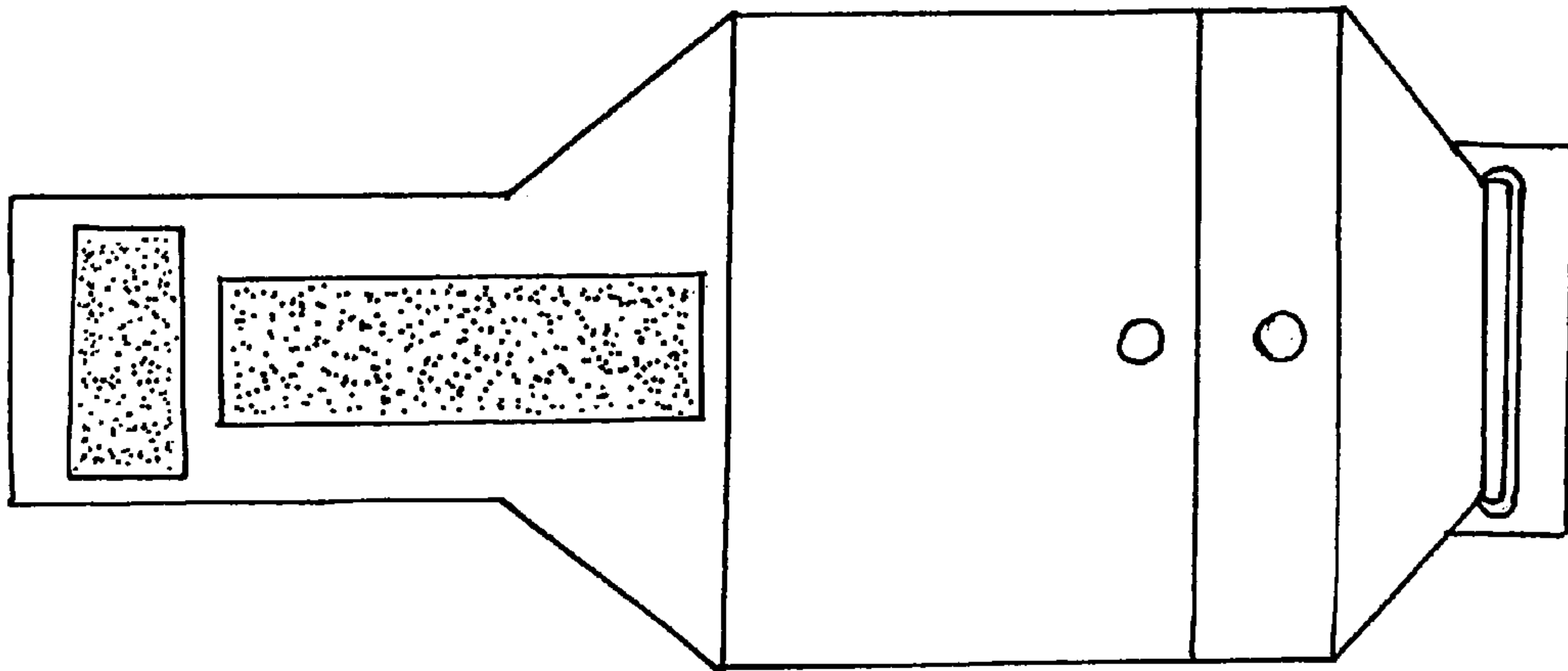

Fig. 1

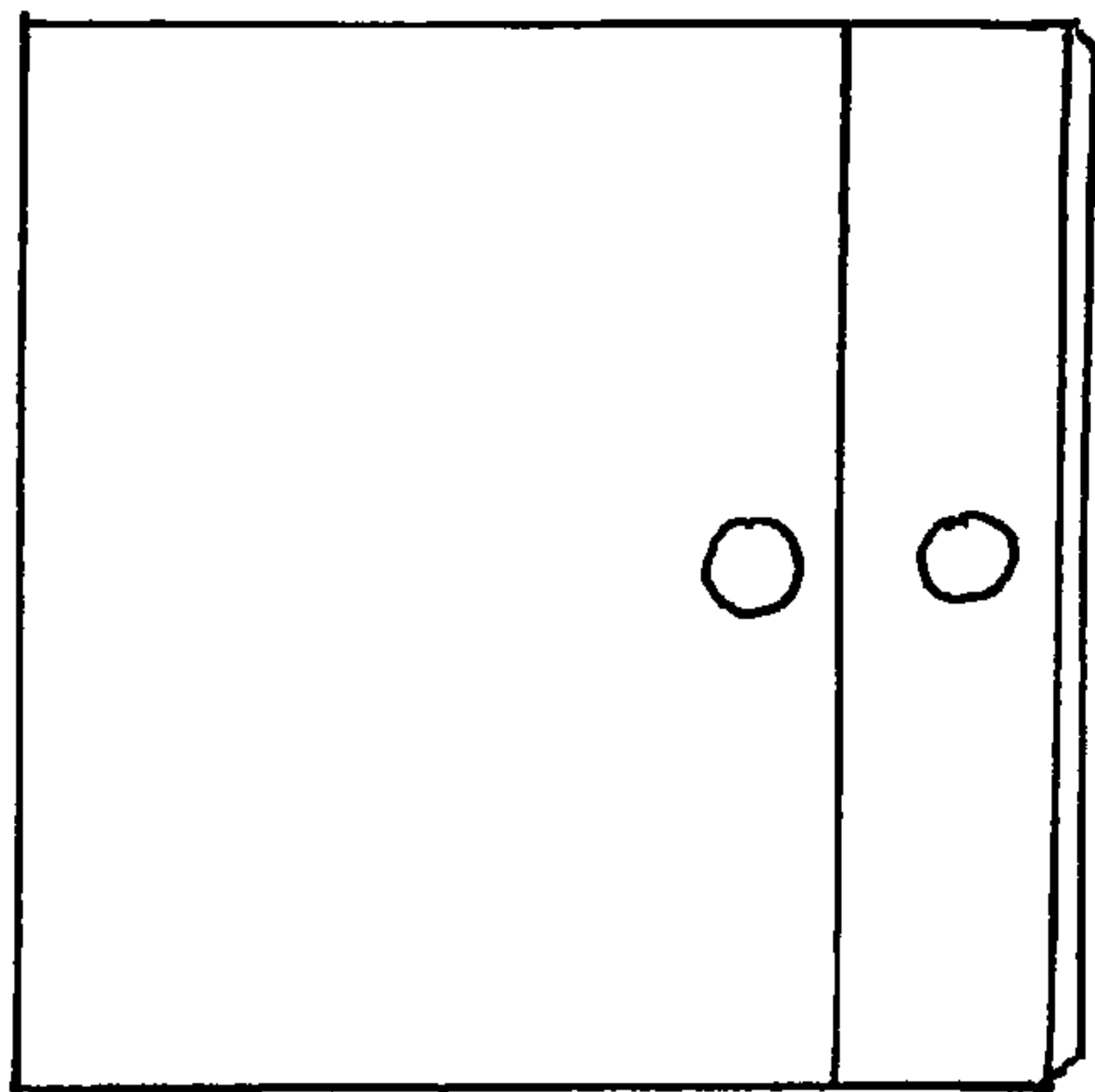

Fig. 2

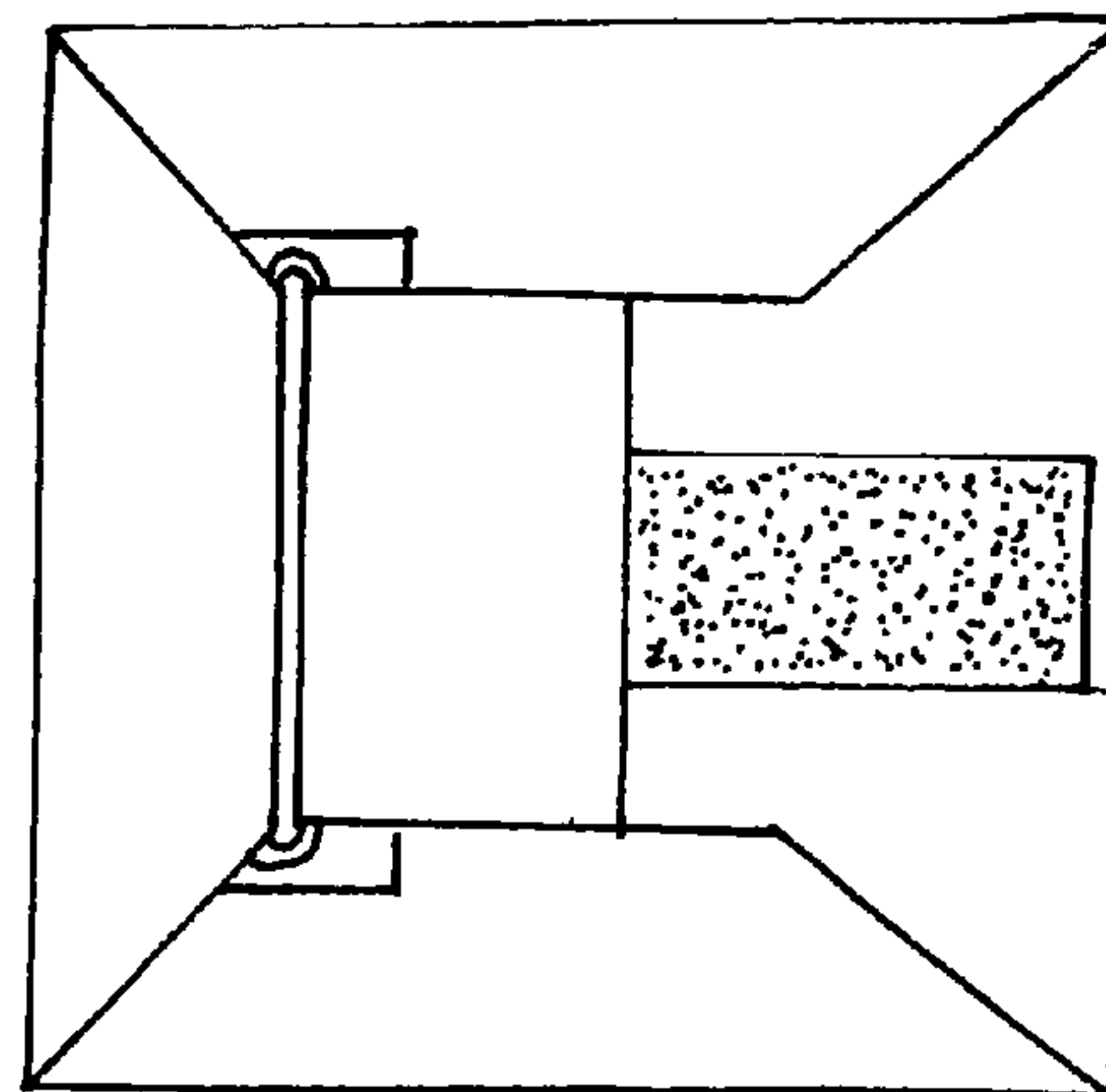

Fig. 3

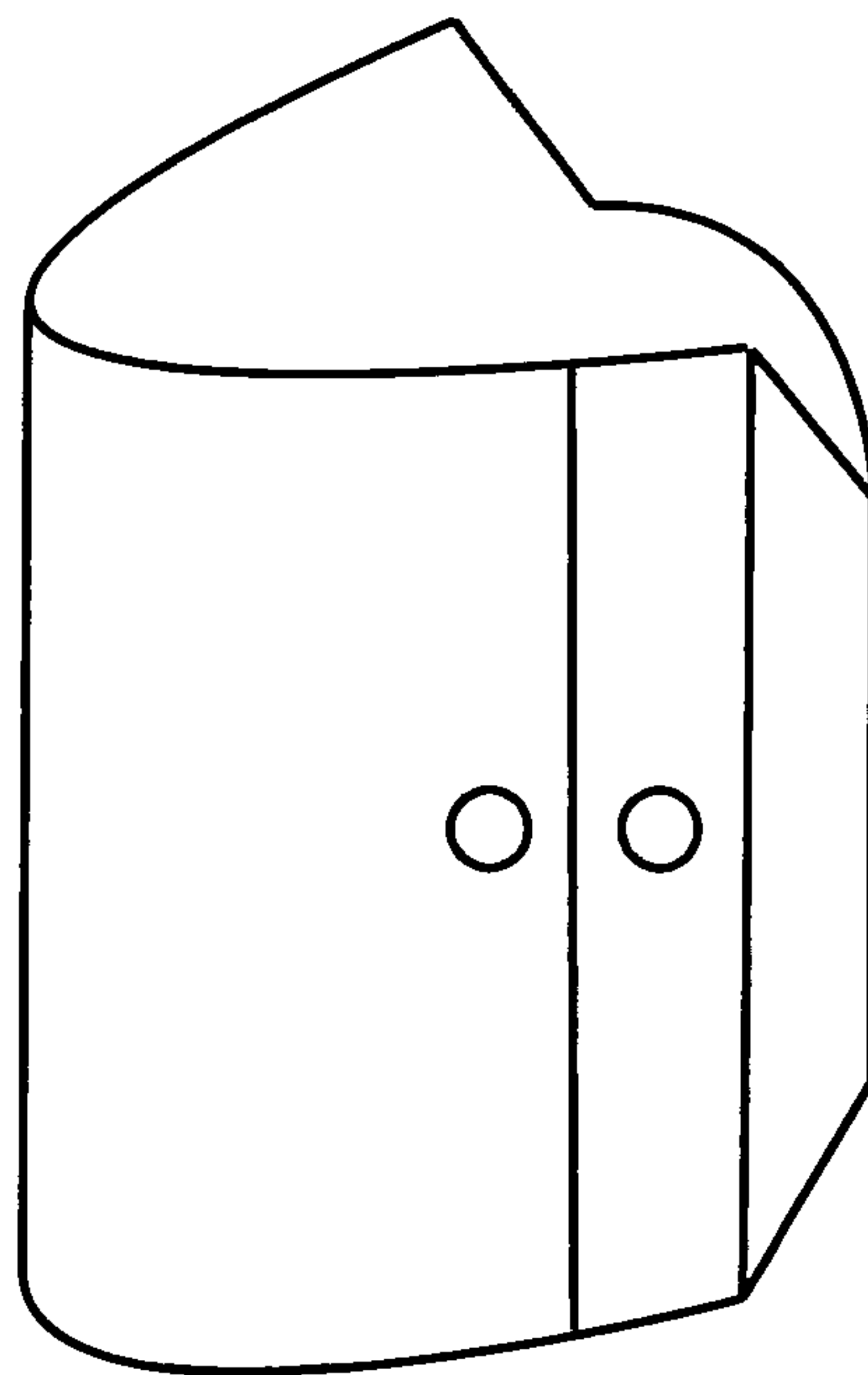

Fig. 4

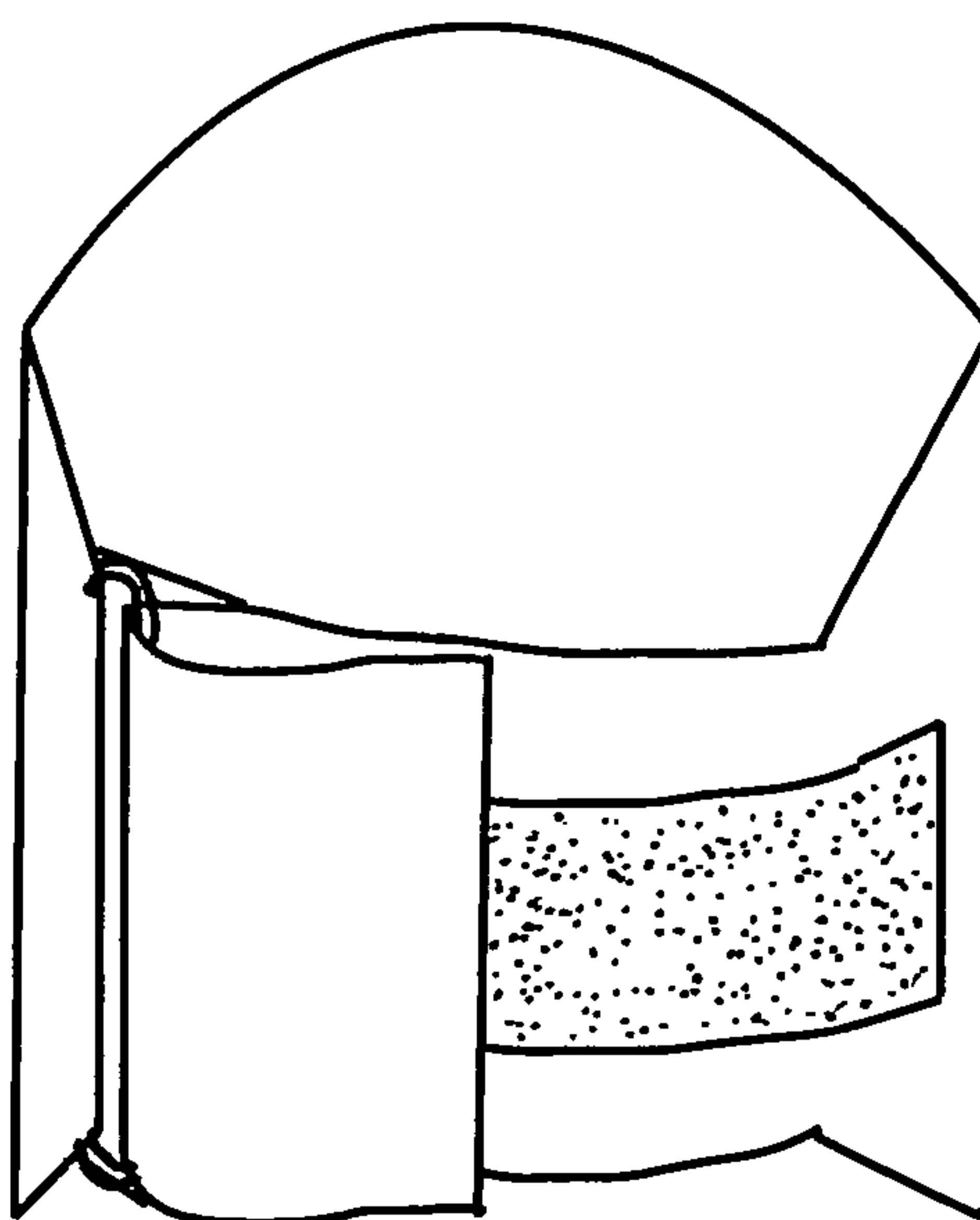

Fig. 5

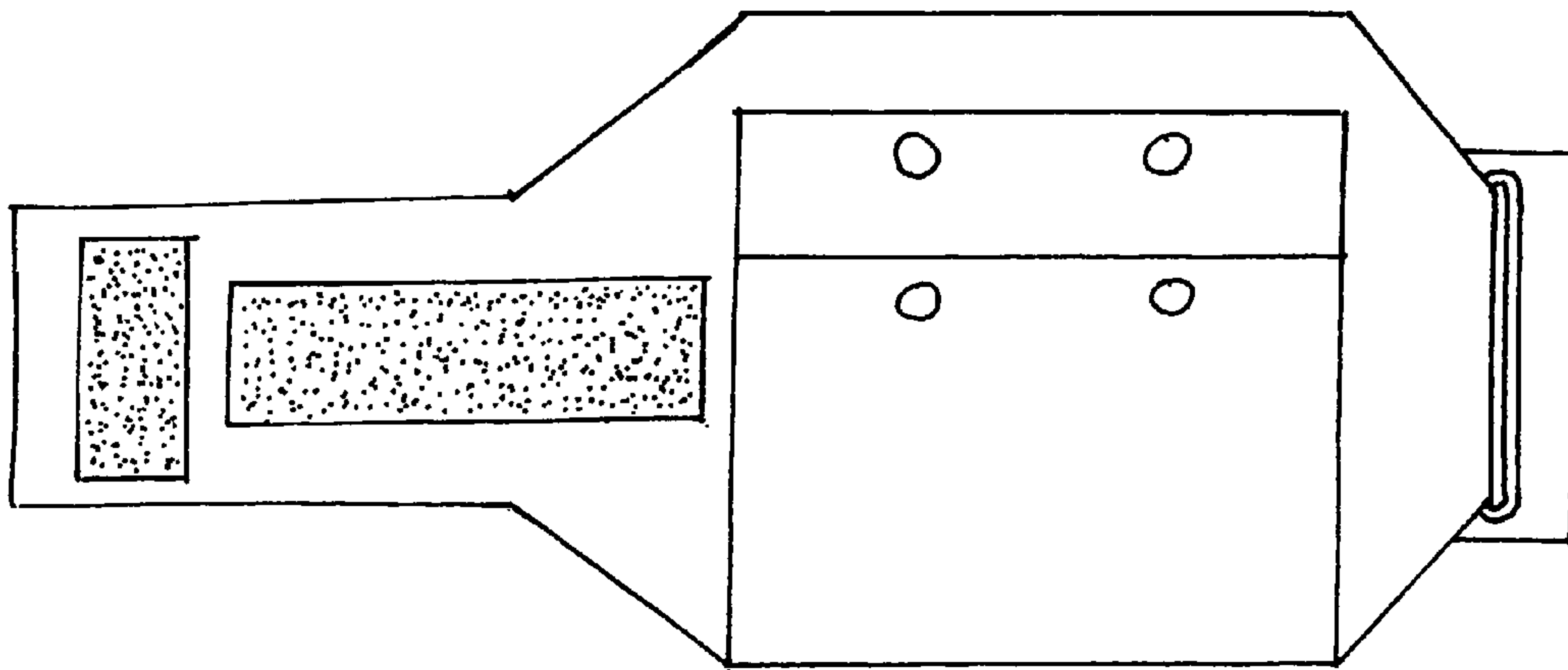

Fig. 6

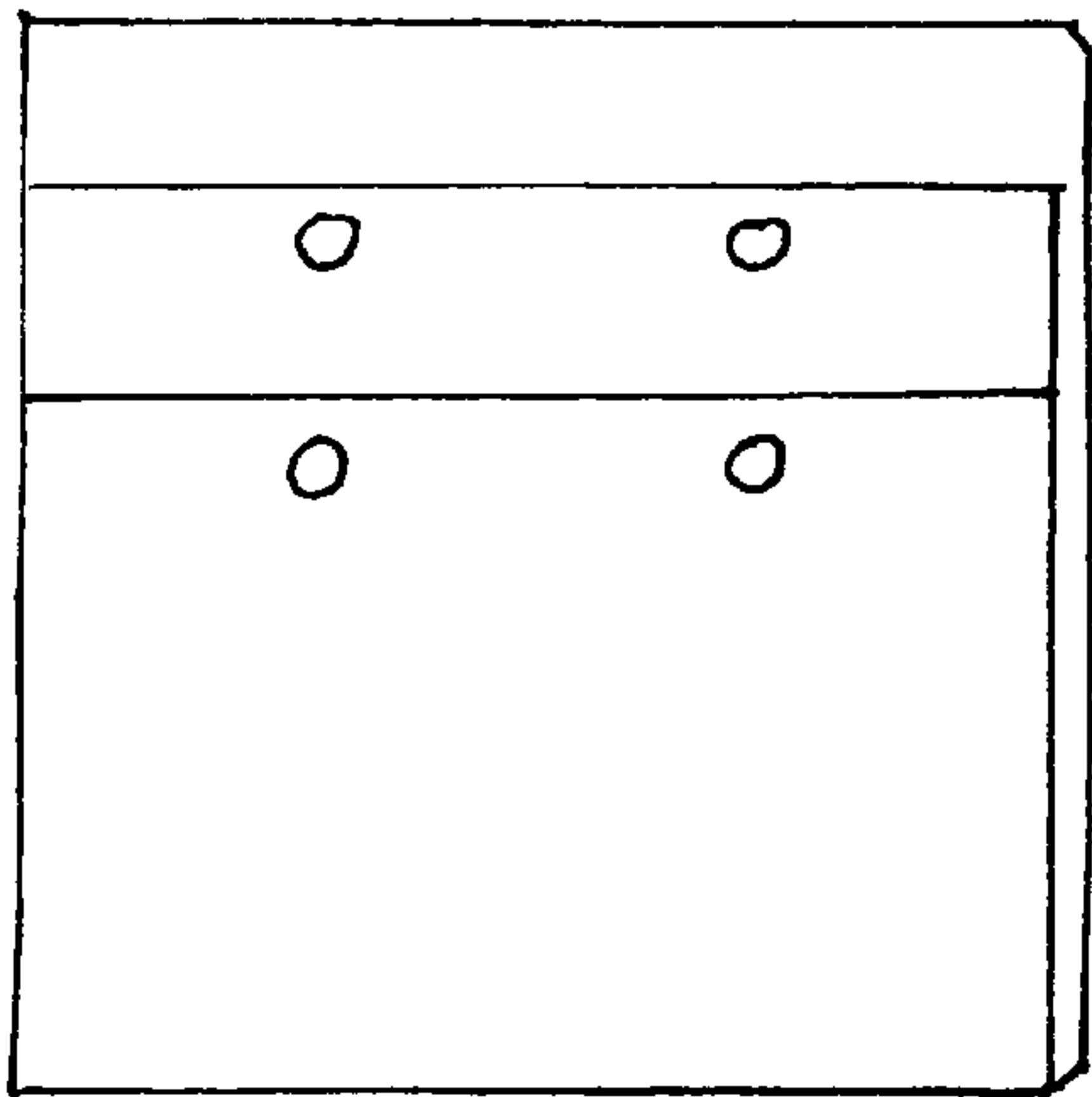

Fig. 7

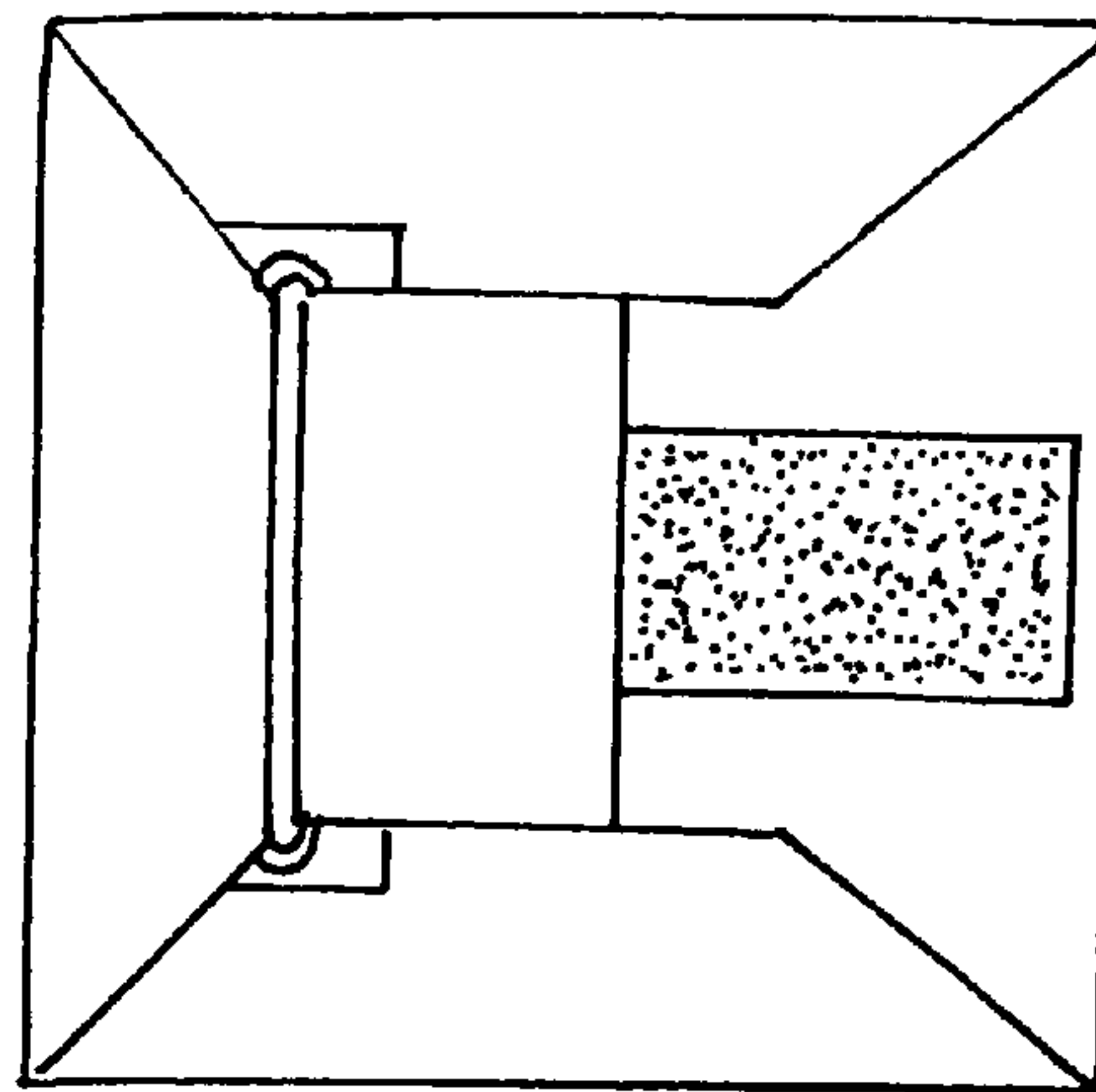

Fig. 8

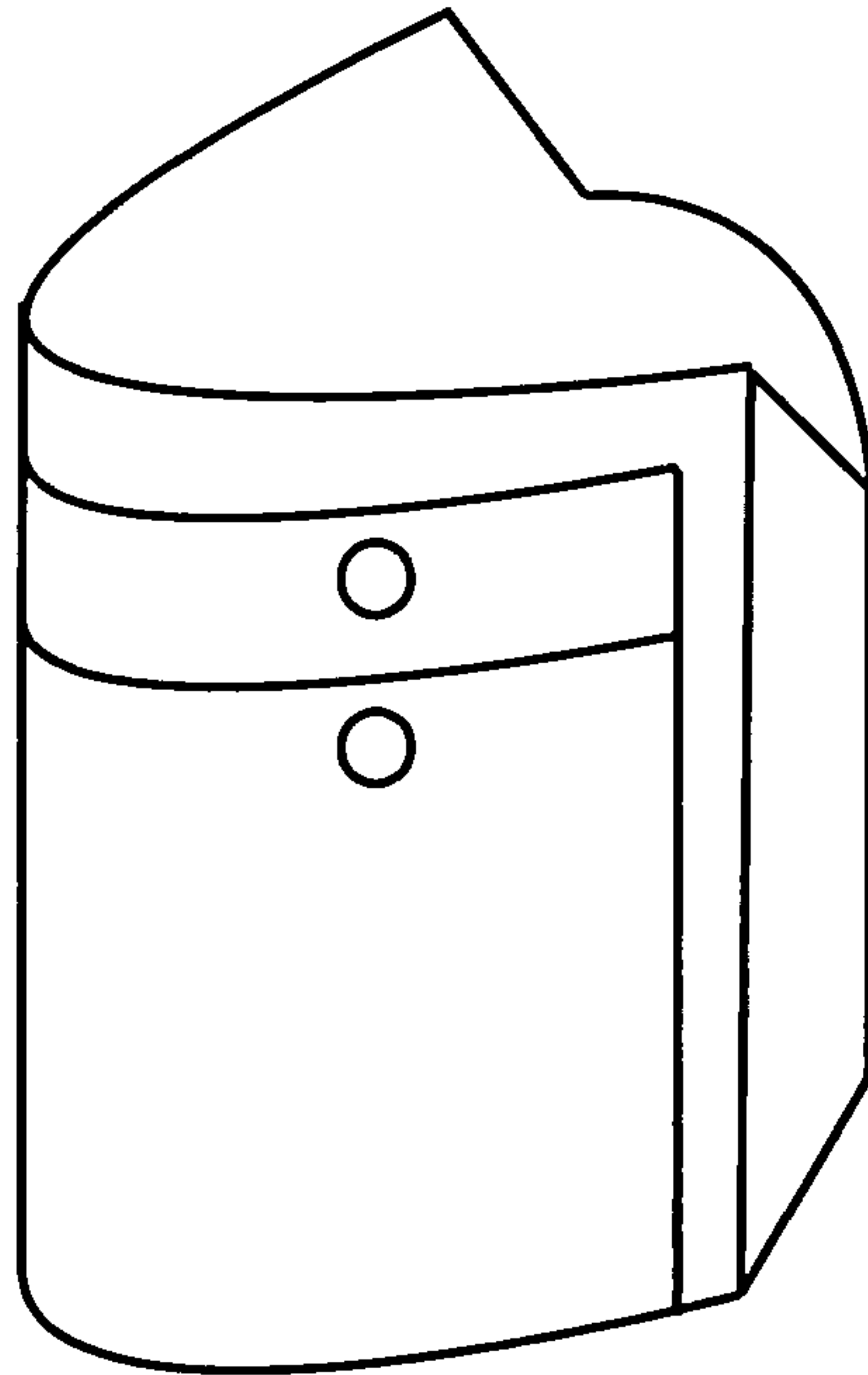

Fig. 9

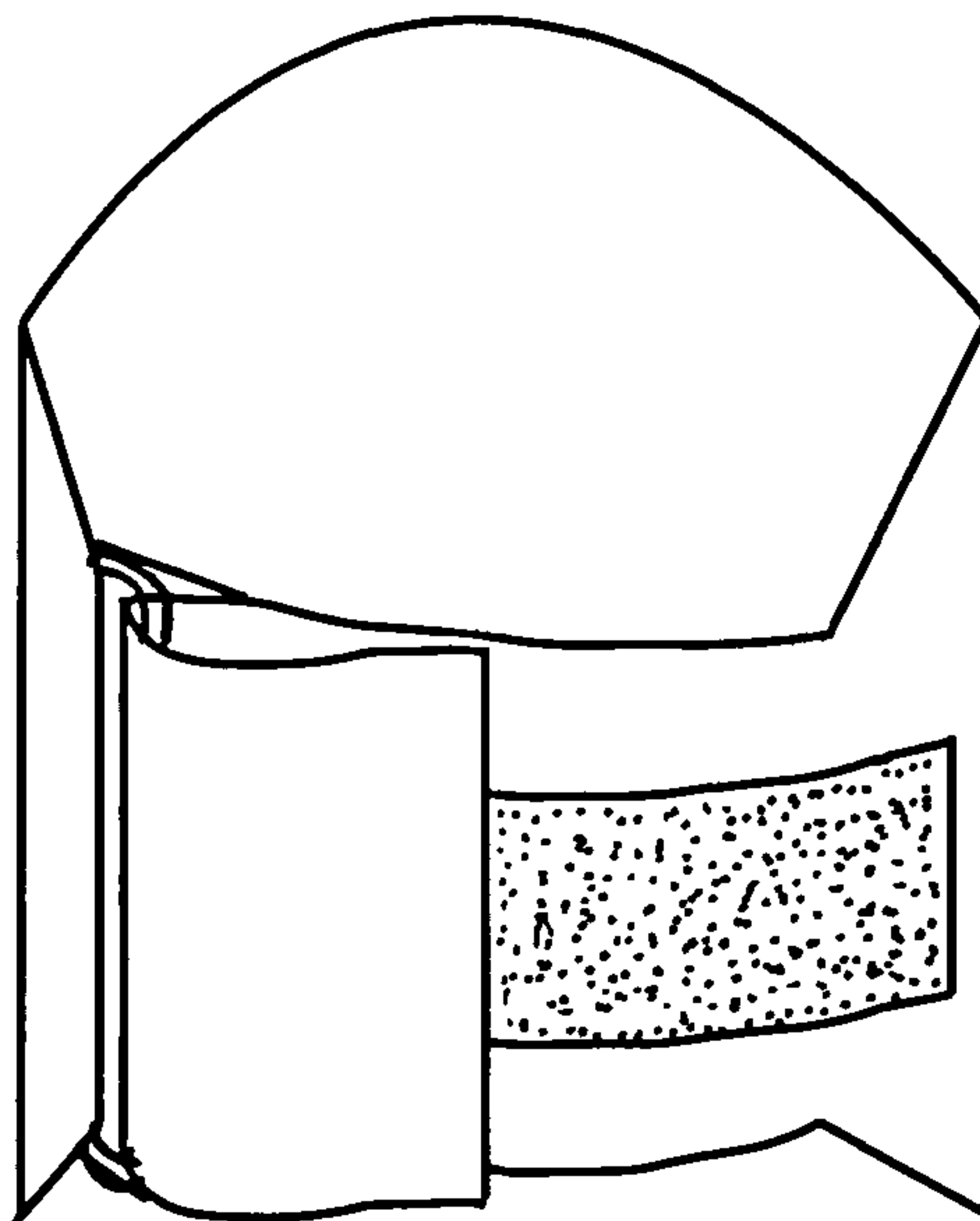

Fig. 10