



US00D732808S

(12) **United States Design Patent**
Del Biondi et al.

(10) **Patent No.:** **US D732,808 S**
(45) **Date of Patent:** **** Jun. 30, 2015**

(54) **FOOTWEAR**

(71) Applicant: **CROCS, INC.**, Niwot, CO (US)

(72) Inventors: **Stefano Del Biondi**, Noventa Padovana (IT); **Federico Fongher**, Villatora di Saonara (IT)

(73) Assignee: **Crocs, Inc.**, Niwot, CO (US)

(**) Term: **14 Years**

(21) Appl. No.: **29/450,686**

(22) Filed: **Mar. 20, 2013**

(51) **LOC (10) Cl.** **02-04**

(52) **U.S. Cl.**
USPC **D2/923**

(58) **Field of Classification Search**
USPC D2/896, 900, 916, 917, 923, 943,
D2/946-96, 969, 972; 36/45, 8, 100, 88,
36/102, 112, 113, 3 A, 3 R, 7.4, 11.5, 4, 87,
36/7.5, 25 R
CPC A43B 1/14; A43B 3/12; A43B 7/08;
A43B 7/06
See application file for complete search history.

(56) **References Cited**

U.S. PATENT DOCUMENTS

D473,040 S	4/2003	Hawker et al.
D498,901 S	11/2004	Hawker et al.
6,993,858 B2	2/2006	Seamans
D517,788 S	3/2006	Seamans
D517,789 S	3/2006	Seamans
D517,790 S	3/2006	Seamans
D525,419 S	7/2006	Seamans
D529,263 S	10/2006	Wolf
7,146,751 B2	12/2006	Seamans
D535,088 S	1/2007	Seamans
D543,341 S	5/2007	Seamans
D543,681 S	6/2007	McCarthy

D545,032 S	6/2007	Wolf	
D545,033 S	6/2007	Wolf	
D561,982 S	2/2008	Hoyt	
D563,082 S	3/2008	Seamans	
D564,184 S *	3/2008	Issler D2/896
D564,204 S	3/2008	Seamans	

(Continued)

FOREIGN PATENT DOCUMENTS

EM	0000611220001 A	8/2003
GB	2322286 A	8/1998

(Continued)

OTHER PUBLICATIONS

Buddy by Calzuro: A New Born in the Calzuro's Family, <http://www.calzuro.it/news.php?lang=en&id=20> (May 13, 2009) (6 pages).

(Continued)

Primary Examiner — Ian Simmons
Assistant Examiner — Rashida C McCoy
(74) *Attorney, Agent, or Firm* — Wilmer Cutler Pickering Hale and Dorr LLP

(57) **CLAIM**

The ornamental design for footwear, as shown and described.

DESCRIPTION

FIG. 1 is a front perspective view of footwear;
FIG. 2 is a front view thereof;
FIG. 3 is a back view thereof;
FIG. 4 is an inner side view thereof;
FIG. 5 is an outer side view thereof;
FIG. 6 is a top view thereof; and,
FIG. 7 is a bottom view thereof.
The portions of the design shown in large broken lines are stitching. The portions of the design shown in small broken lines form no part of the claimed design.

1 Claim, 7 Drawing Sheets

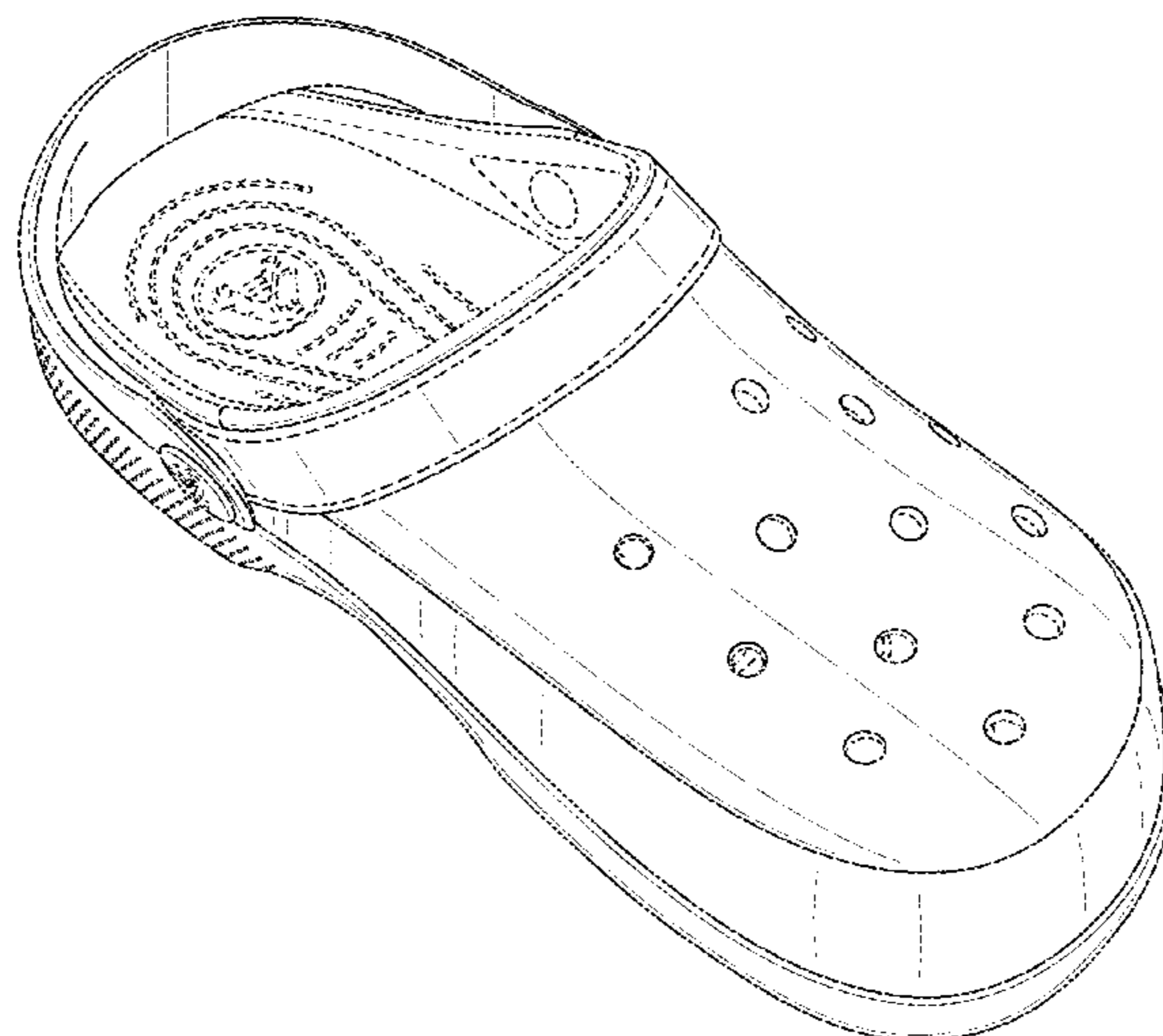

(56)

References Cited

U.S. PATENT DOCUMENTS

D564,205 S 3/2008 Seamans
D564,207 S 3/2008 Seamans
D564,208 S 3/2008 Seamans
D564,749 S 3/2008 Seamans
D567,482 S 4/2008 Hoyt
D567,483 S 4/2008 Liow
D573,778 S 7/2008 Hawker
D575,937 S 9/2008 Klavano
D578,743 S 10/2008 Liow
D579,182 S 10/2008 Klavano
D579,651 S 11/2008 Hearn
D584,032 S 1/2009 Jarosik
D584,037 S 1/2009 Del Biondi et al.
D590,588 S 4/2009 Del Biondi et al.
D593,287 S 6/2009 Del Biondi et al.
D599,538 S 9/2009 Del Biondi et al.
D600,907 S 9/2009 Boyd et al.
D610,784 S 3/2010 Del Biondi
D621,596 S * 8/2010 Seilles et al. D2/969

D624,733 S * 10/2010 O'Boyle et al. D2/923
D630,006 S * 1/2011 Voare et al. D2/923
D630,007 S * 1/2011 Satz D2/923
D664,753 S 8/2012 Santos
D667,612 S * 9/2012 Del Biondi et al. D2/896
2004/0231189 A1 11/2004 Seamans
2004/0231190 A1 11/2004 Seamans
2004/0231191 A1 11/2004 Seamans
2006/0048407 A1 3/2006 Seamans
2007/0130797 A1 6/2007 Seamans

FOREIGN PATENT DOCUMENTS

WO WO2004105531 A1 12/2004
WO WO2004105534 A2 12/2004

OTHER PUBLICATIONS

Crocs: Cayman, <http://www.crocs.com/crocs-cayman/10001.default.pd.html?q=cayman> (Nov. 3, 2009) (6 pages).

* cited by examiner

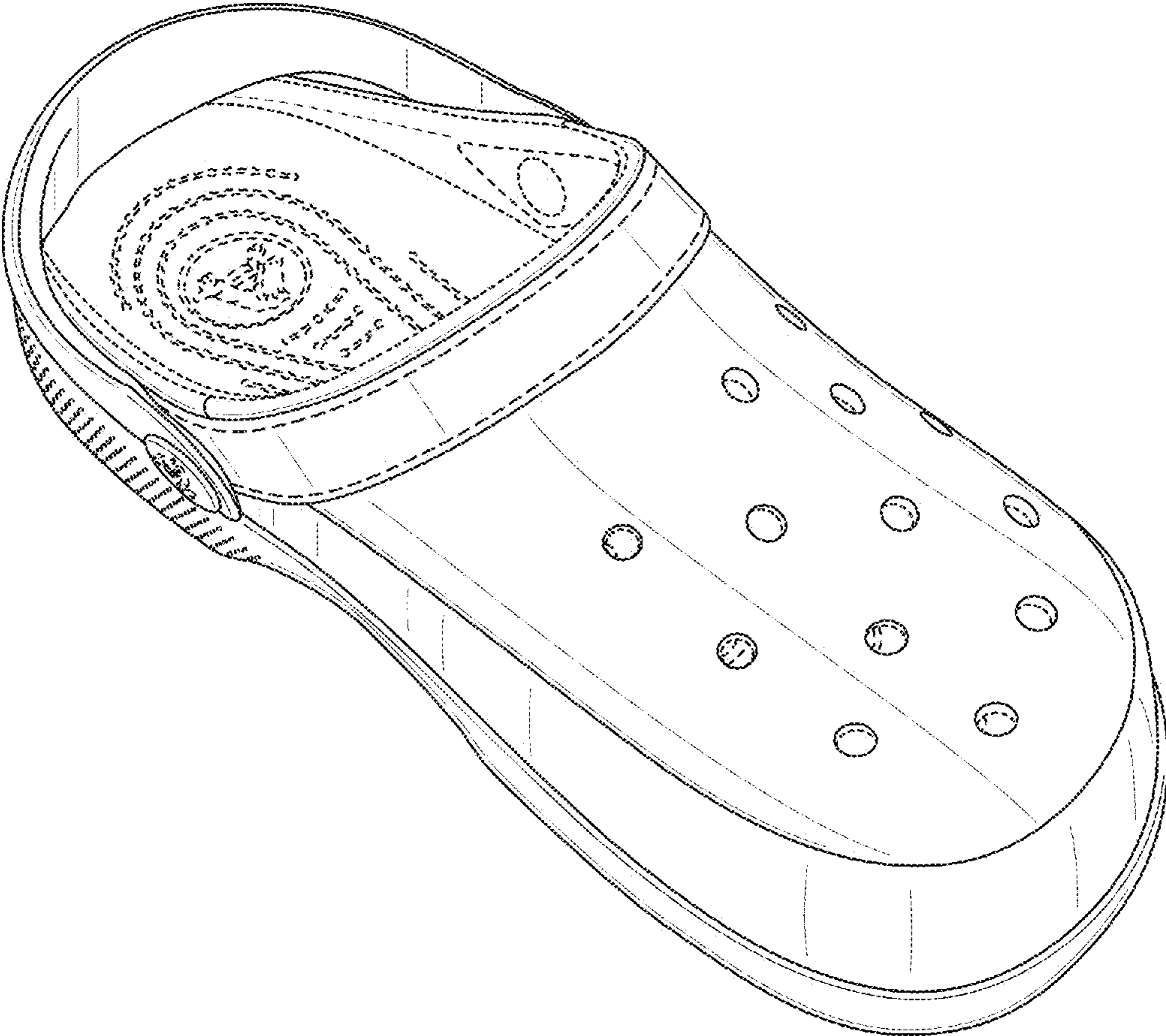

FIG. 1

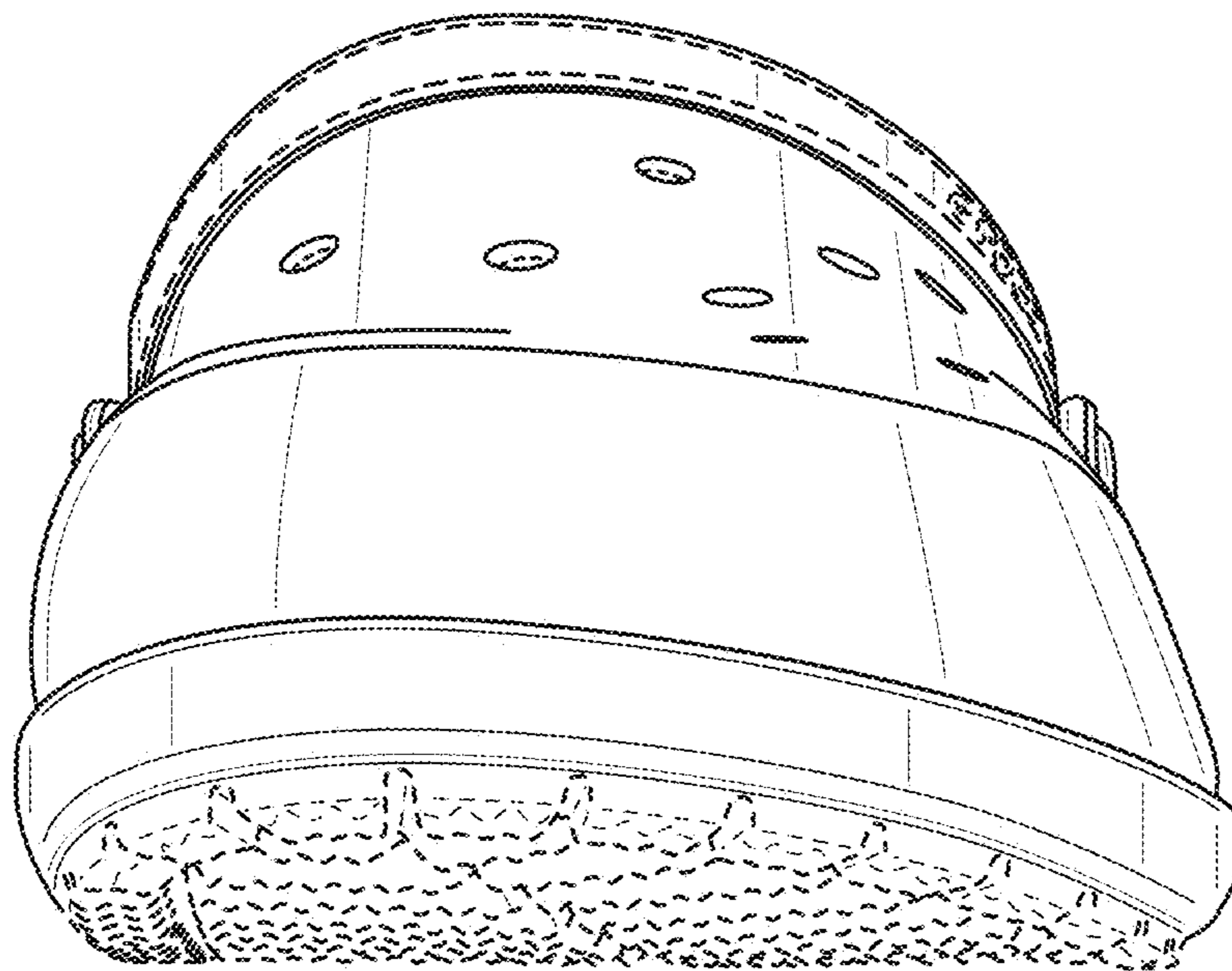

FIG. 2

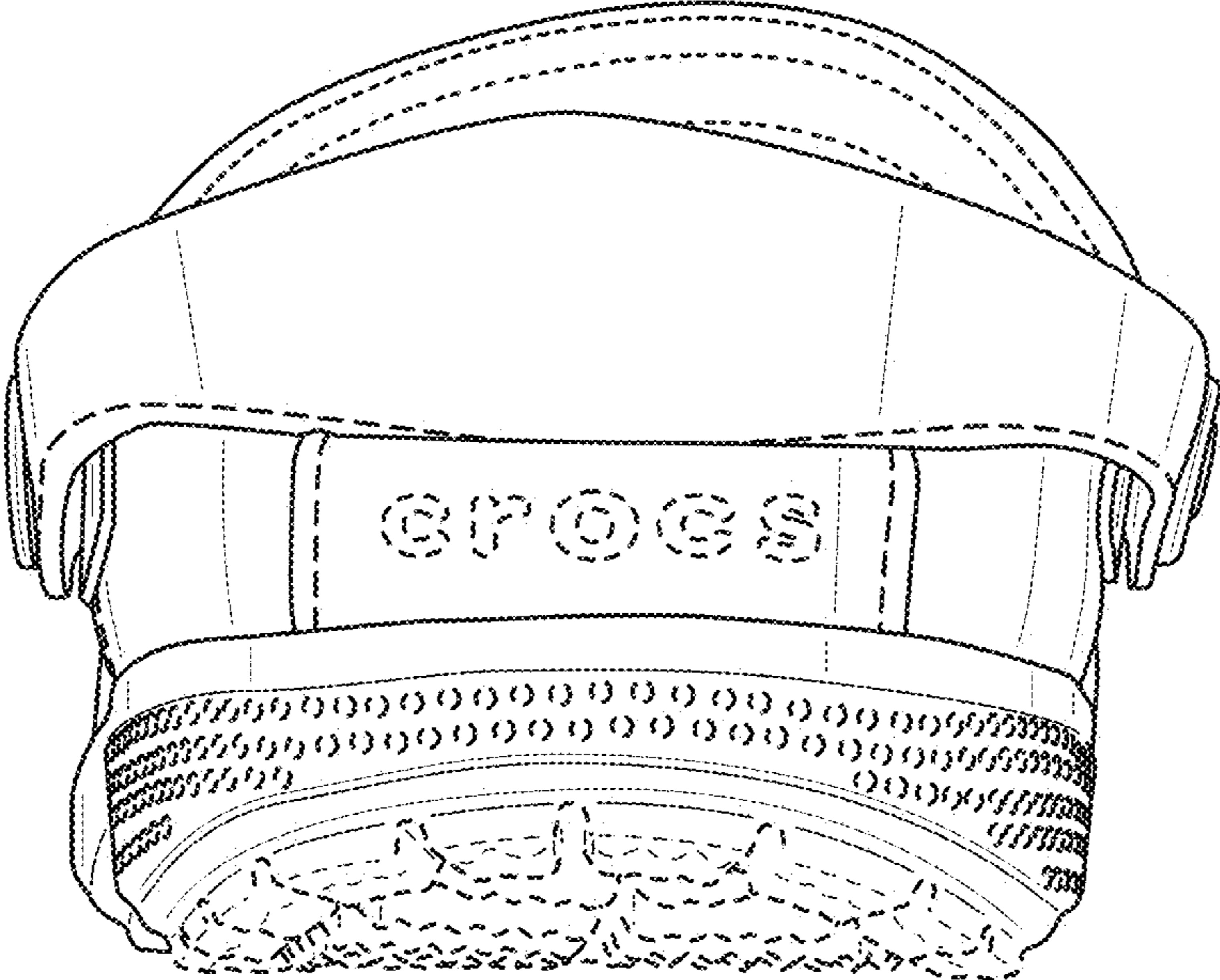

FIG. 3

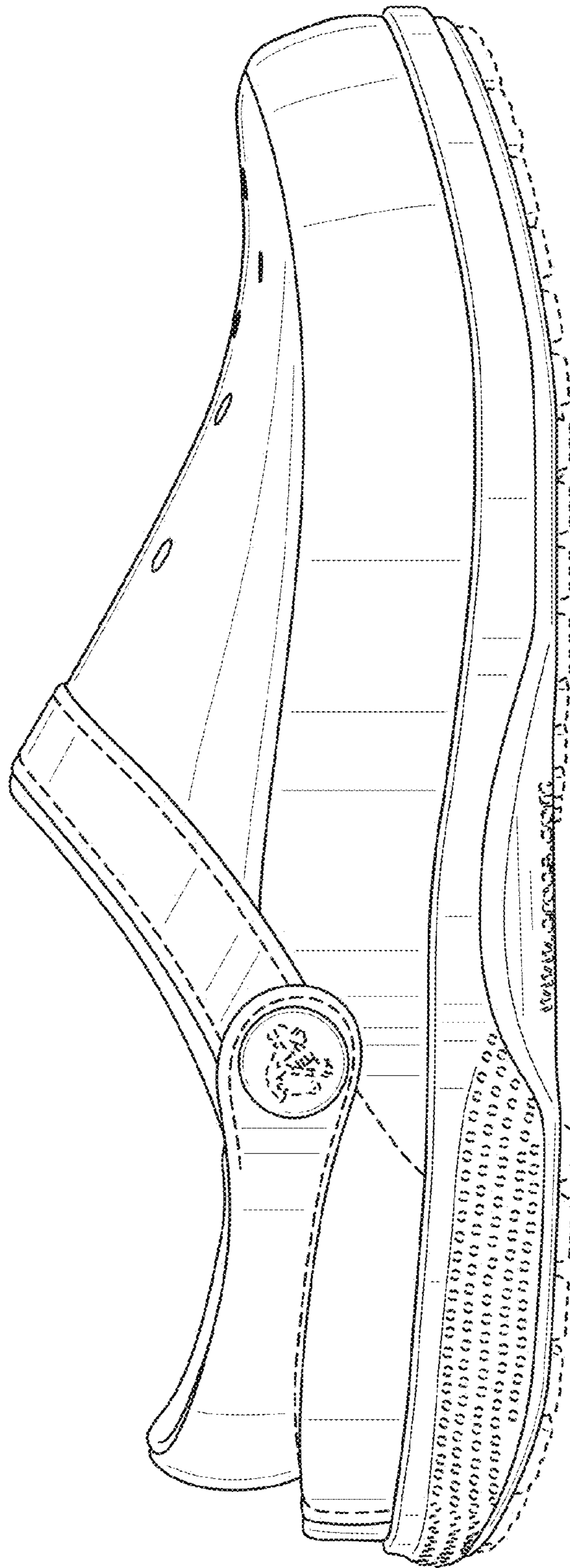

FIG. 4

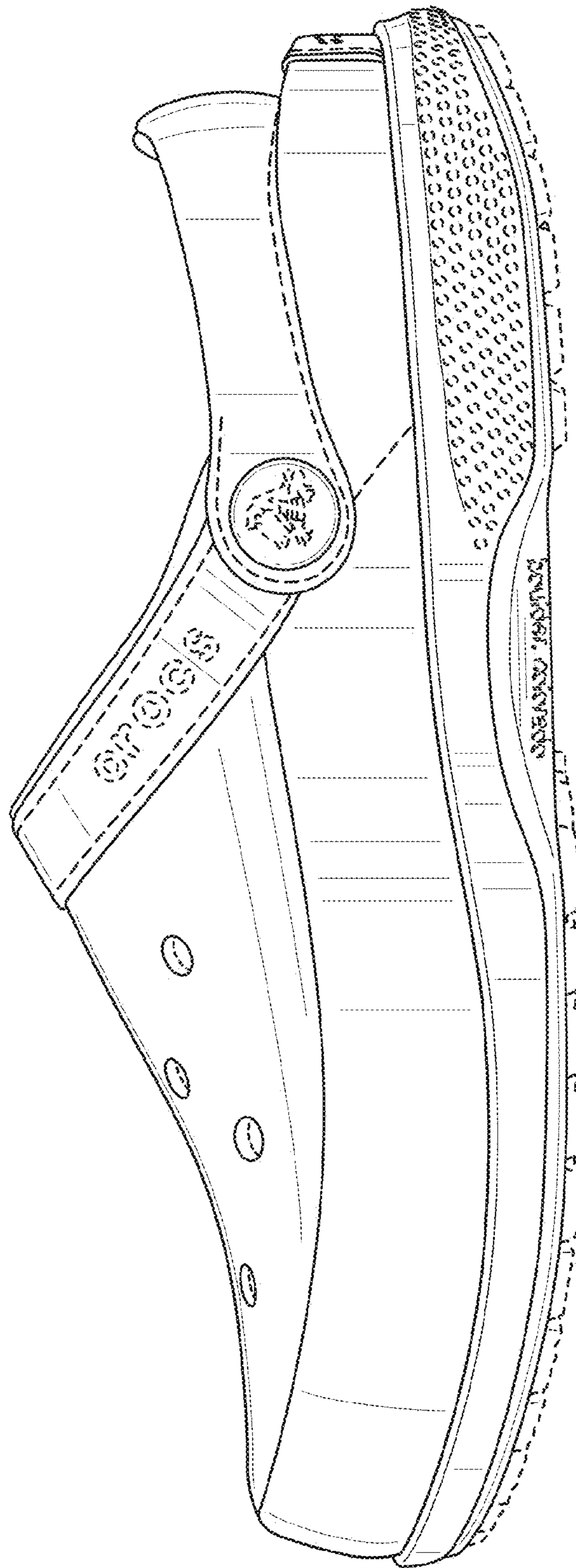

FIG. 5

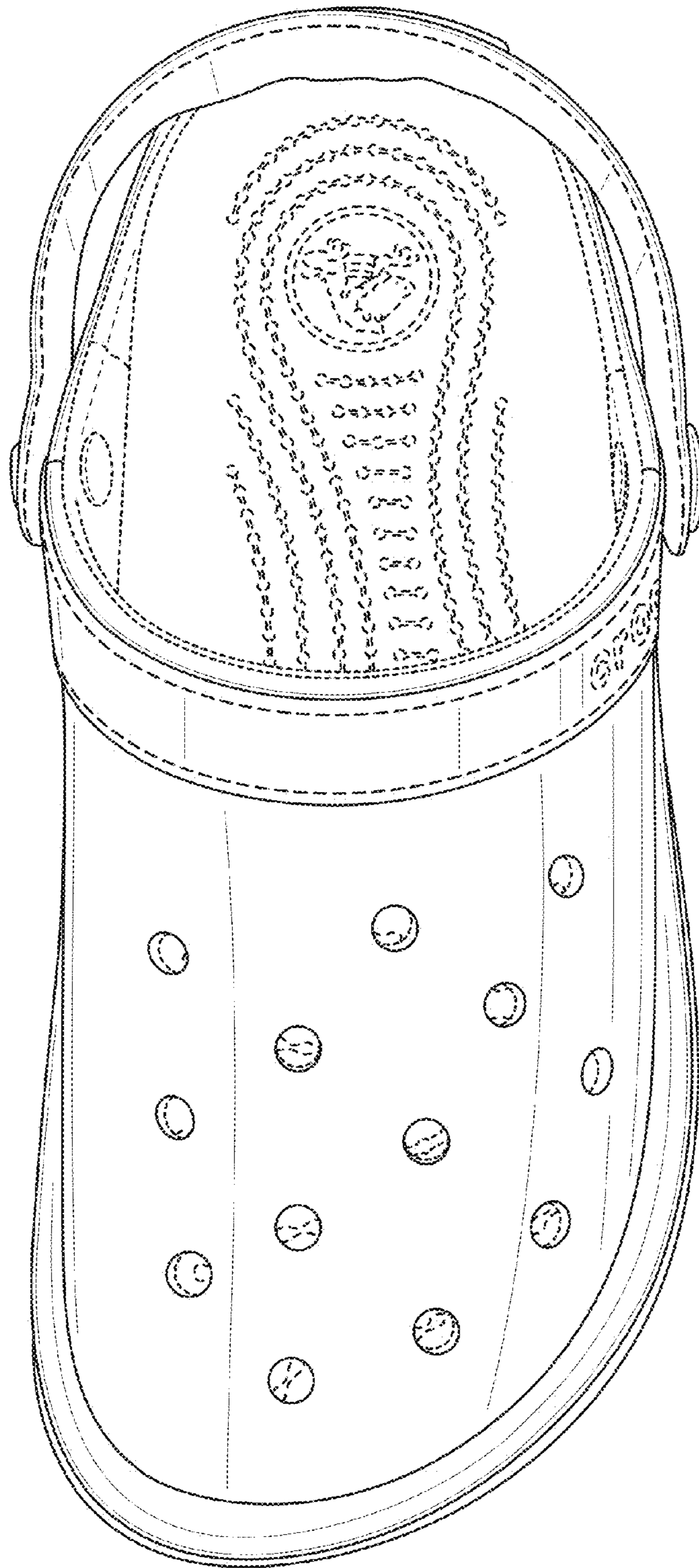

FIG. 6

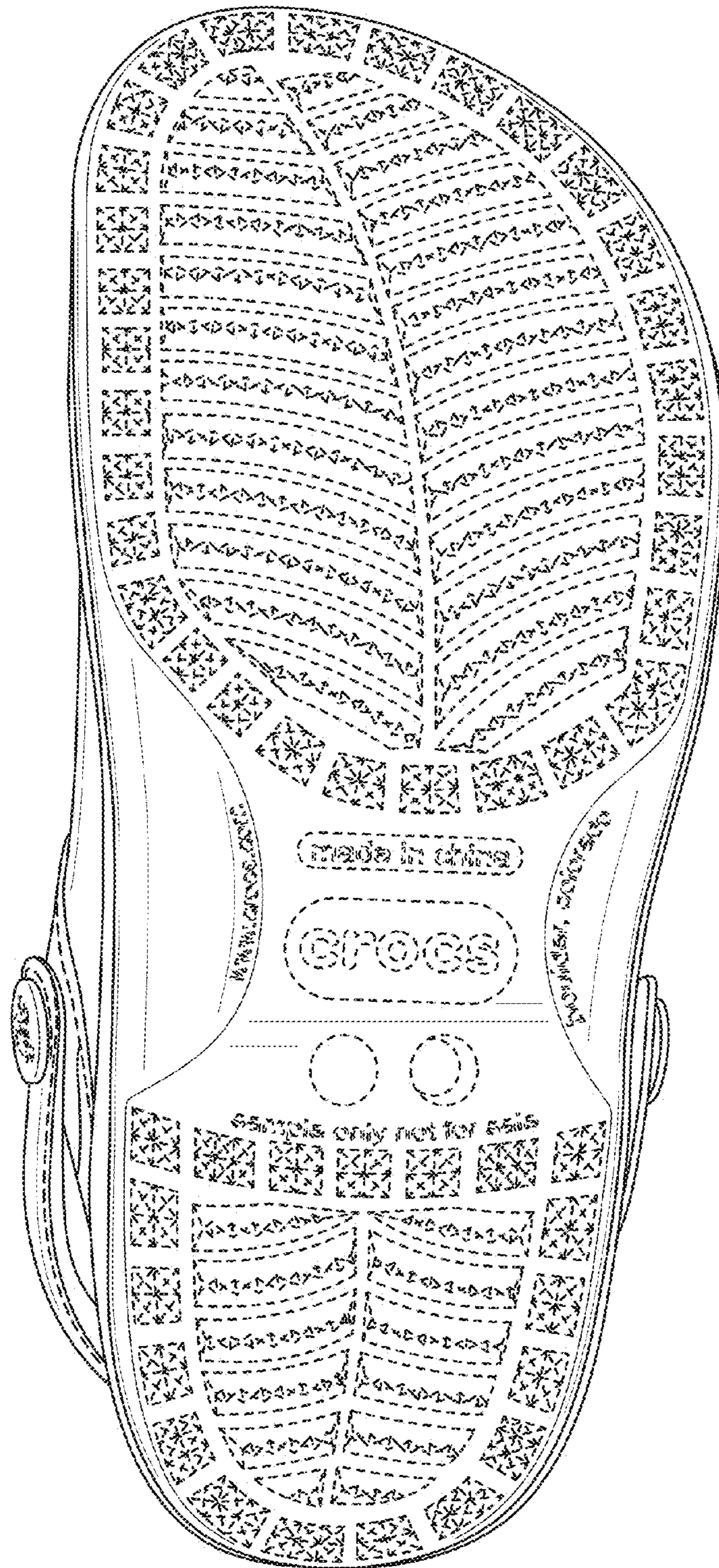

FIG. 7