



US00D732752S

(12) **United States Design Patent**  
**Osborne**

(10) **Patent No.:** **US D732,752 S**  
(45) **Date of Patent:** **\*\* Jun. 23, 2015**

(54) **HORSE ORTHOTIC**

(71) Applicant: **Robert Clark Osborne**, Lakeside, CA  
(US)

(72) Inventor: **Robert Clark Osborne**, Lakeside, CA  
(US)

(\*\*) Term: **14 Years**

(21) Appl. No.: **29/472,255**

(22) Filed: **Nov. 11, 2013**

**Related U.S. Application Data**

(63) Continuation of application No. 29/429,133, filed on Aug. 7, 2012, now Pat. No. Des. 693,525, which is a continuation of application No. 13/480,975, filed on May 25, 2012, now abandoned, which is a continuation of application No. 12/535,258, filed on Aug. 4, 2009, now Pat. No. 8,186,447.

(51) **LOC (10) Cl.** ..... **30-01**

(52) **U.S. Cl.**  
USPC ..... **D30/148**

(58) **Field of Classification Search**  
USPC ..... D30/146-150; 119/814; 54/82;  
168/1-5, 11-18, 22-33; 473/591;  
D9/650; D21/387

See application file for complete search history.

(56) **References Cited**

**U.S. PATENT DOCUMENTS**

152,640	A *	6/1874	Hurlbut	168/1
D30,968	S	6/1899	Howe	
RE11,942	E	11/1901	Bayless	
798,598	A	9/1905	Conn	
866,127	A	9/1907	Glassbrooke	
1,148,886	A	8/1915	Bird	
1,212,266	A	1/1917	Schrader	
D86,590	S	1/1932	Adams	
2,045,845	A	9/1935	Flick	
2,079,736	A	11/1935	Frazier	

D125,788	S	7/1940	Singer	
2,506,932	A	11/1945	McAfee	
2,497,410	A	8/1948	Kettig	
3,302,723	A	2/1967	Renkenberger et al.	
D213,009	S	12/1968	Martz	
D229,951	S	1/1974	Poole	
D230,284	S *	2/1974	Shenton	D30/148
3,967,683	A	7/1976	Ensinozo	
4,212,356	A	7/1980	Battle	
4,265,454	A	5/1981	Bayless	
4,346,762	A	8/1982	Tovim	
D285,499	S *	9/1986	Nakanishi	D30/149
D295,907	S *	5/1988	Decker	D30/143
4,819,731	A *	4/1989	Stubbe	168/4
4,892,150	A	1/1990	Thoman	
4,982,797	A	1/1991	Monticello	
5,042,585	A	8/1991	Fox et al.	
5,105,892	A	4/1992	Seesholtz	
5,148,872	A *	9/1992	Dallmer	168/11
5,253,715	A	10/1993	Ovnicsek	
5,330,008	A	7/1994	Sigafoos et al.	

(Continued)

*Primary Examiner* — George D Kirschbaum

*Assistant Examiner* — Jennifer Watkins

(74) *Attorney, Agent, or Firm* — Knobbe Martens Olson & Bear LLP

(57) **CLAIM**

The ornamental design for a horse orthotic, as shown and described.

**DESCRIPTION**

FIG. 1 is a bottom view of a horse orthotic configured in accordance with the present invention;  
FIG. 2 is a side view thereof;  
FIG. 3 is a perspective view thereof;  
FIG. 4 is a top view thereof;  
FIG. 5 is a front view thereof; and,  
FIG. 6 is a back view thereof.  
The broken lines illustrate unclaimed features.  
The broken lines illustrate portions of the horse orthotic that form no part of the claimed design.

**1 Claim, 6 Drawing Sheets**

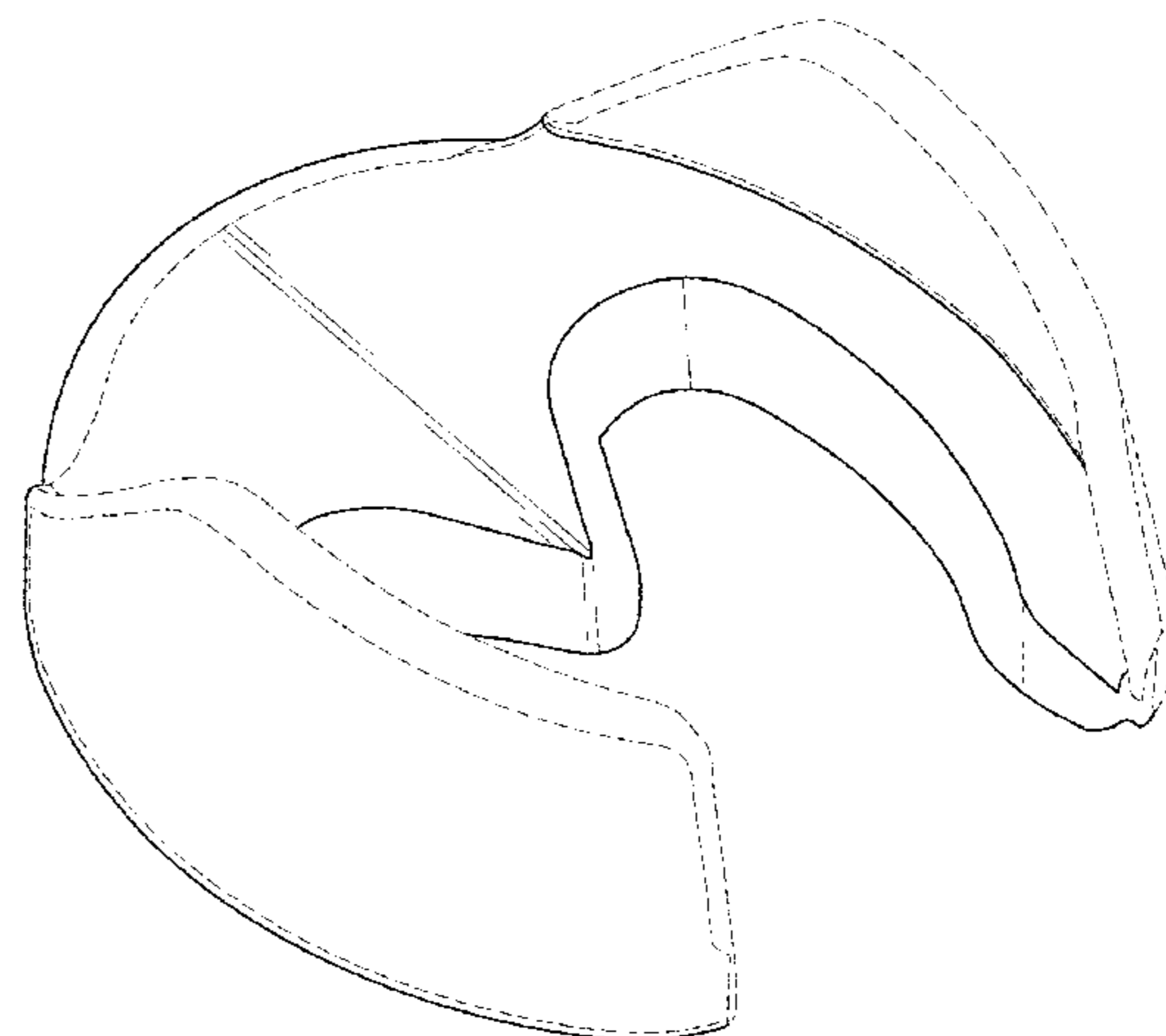
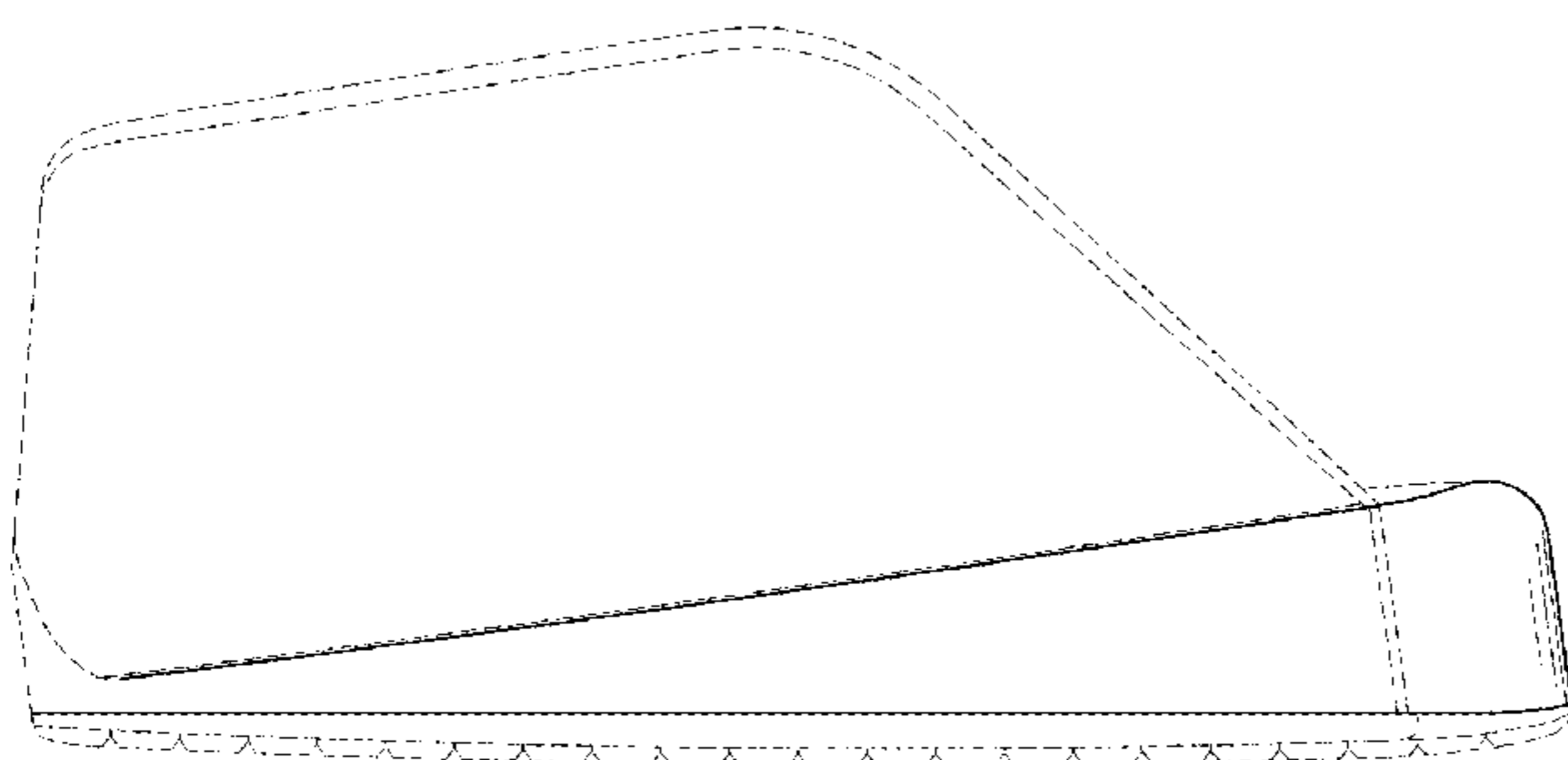

(56)

**References Cited**

U.S. PATENT DOCUMENTS

5,358,256 A	10/1994	Kraemer	6,868,656 B2	3/2005	Osha et al.
5,439,062 A	8/1995	Ovnicek	7,032,367 B1	4/2006	Yoho
5,588,288 A *	12/1996	Origgi et al. .... 54/82	7,174,858 B2	2/2007	Ford
5,636,697 A	6/1997	Pitchford	7,178,321 B2	2/2007	Ruetenik
5,638,905 A	6/1997	Sigafoos et al.	7,207,163 B2	4/2007	Maestrini
5,699,861 A	12/1997	Sigafoos	7,789,394 B2	9/2010	Lendvay
5,727,633 A	3/1998	Ovnicek	7,806,194 B2	10/2010	Vaillant
6,062,008 A	5/2000	Nor	D644,271 S	8/2011	Osborne
D440,363 S *	4/2001	Ford ..... D30/147	8,151,546 B2 *	4/2012	Ford ..... 54/82
6,305,328 B1	10/2001	Marquis	8,186,447 B2	5/2012	Osborne
6,516,594 B2 *	2/2003	Clark et al. .... 54/82	D683,084 S *	5/2013	Lander ..... D30/148
6,651,410 B2	11/2003	Osha et al.	D689,246 S *	9/2013	Blair et al. .... D30/148
6,694,713 B1	2/2004	MacDonald	D693,525 S *	11/2013	Osborne ..... D30/149
6,761,224 B2	7/2004	McLane	2005/0126793 A1	6/2005	McCuan et al.
			2009/0120650 A1	5/2009	Daine
			2010/0031614 A1 *	2/2010	Osborne ..... 54/82

\* cited by examiner

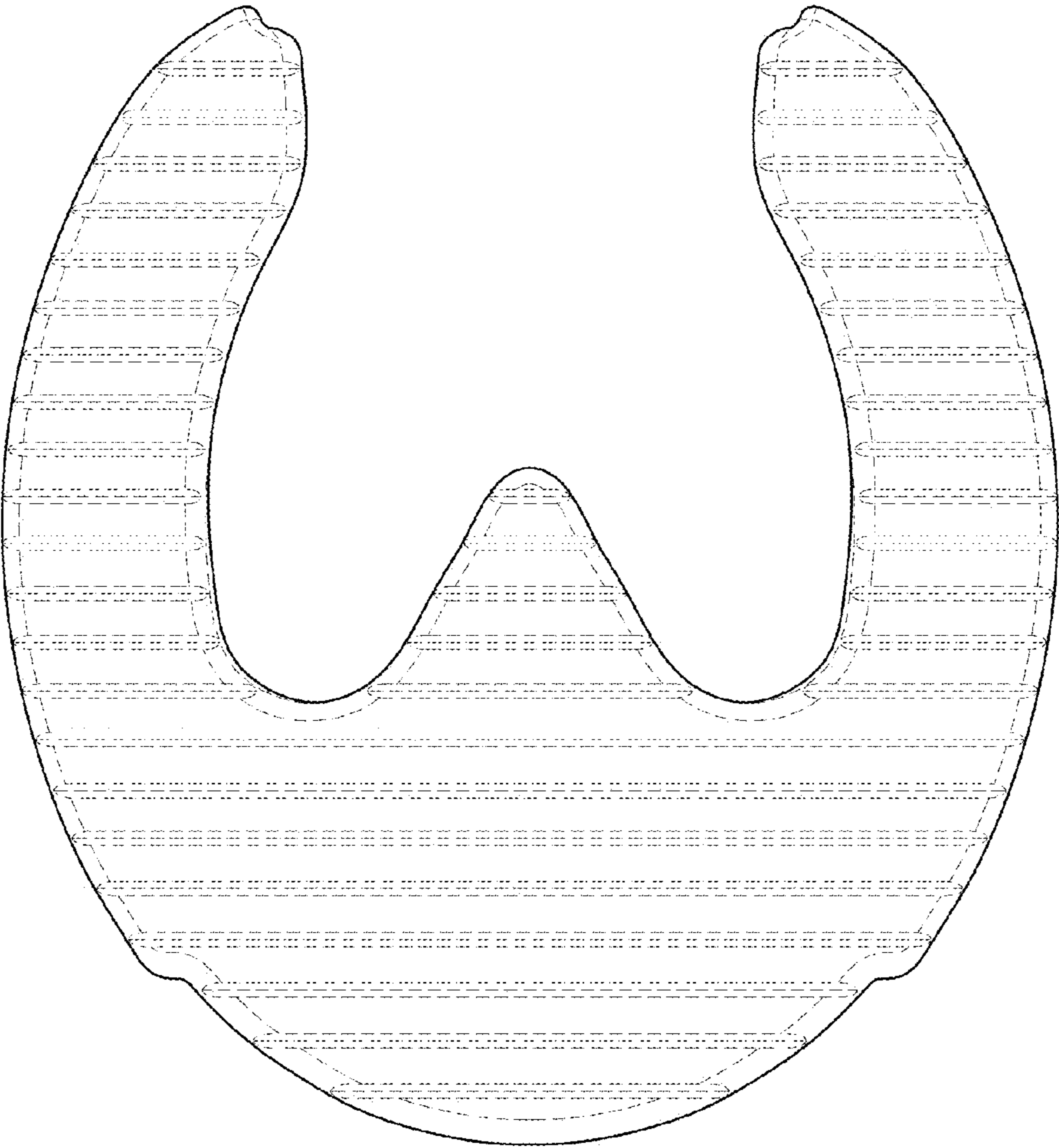
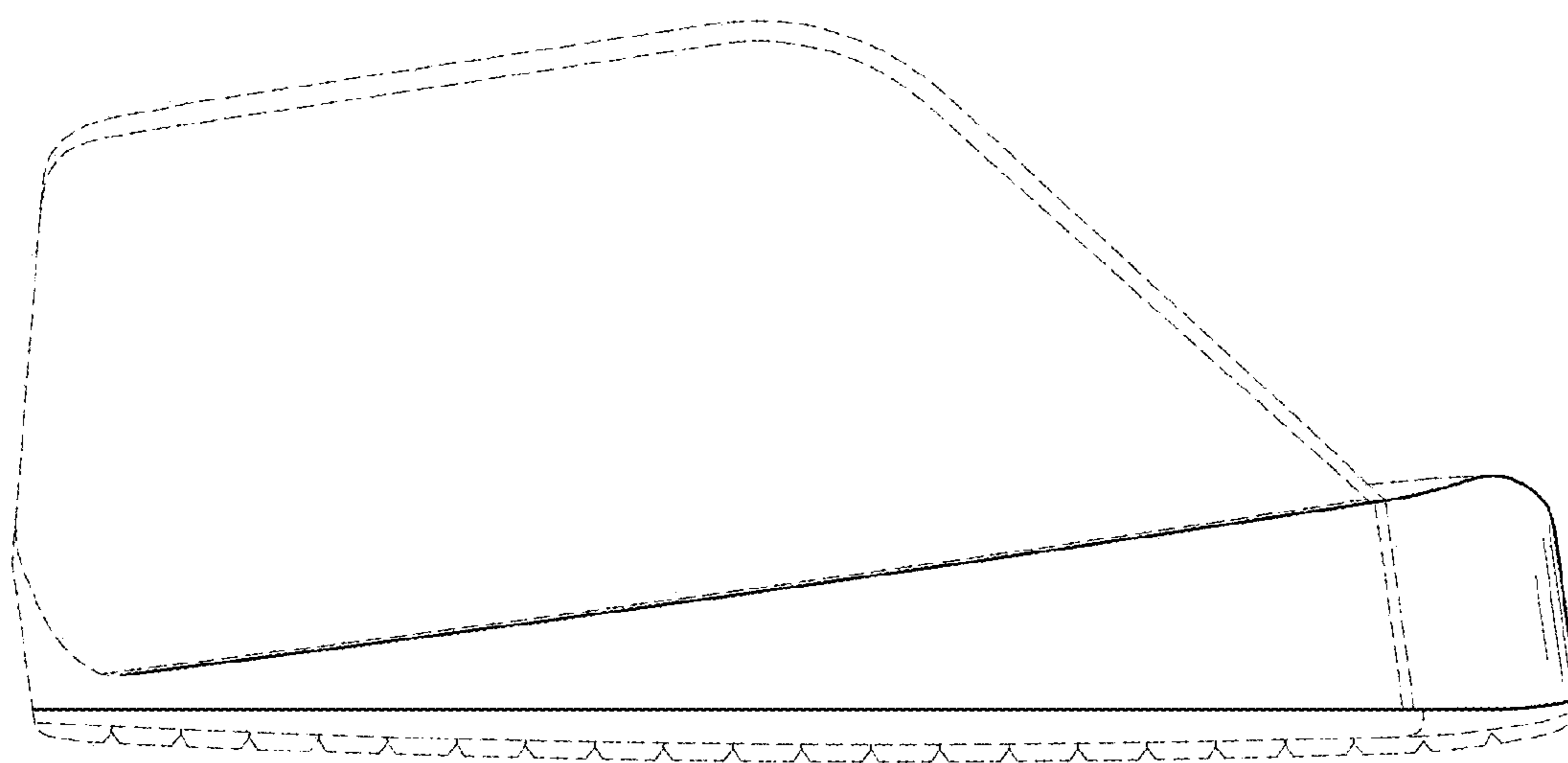
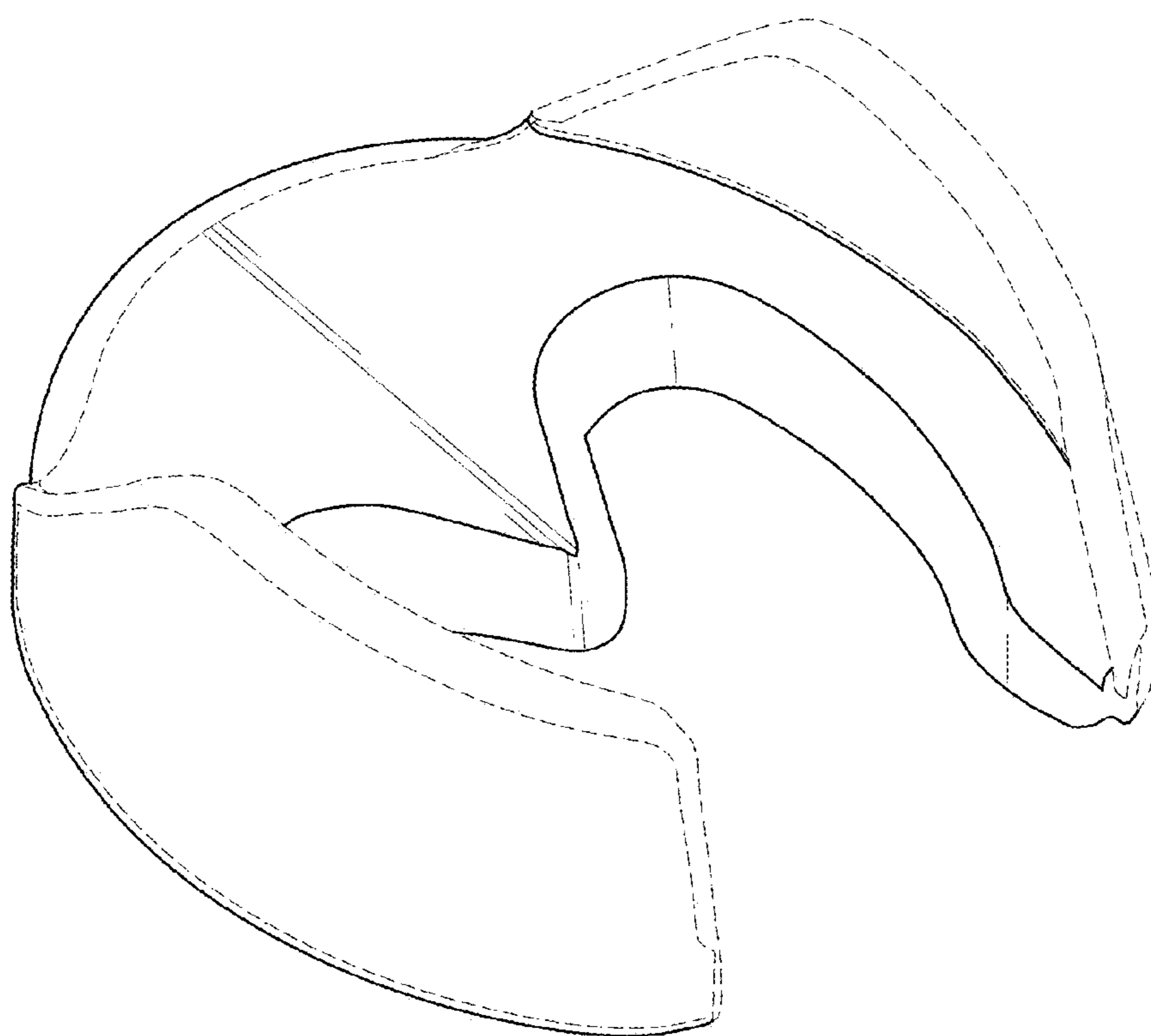

FIG. 1



*FIG. 2*



*FIG. 3*

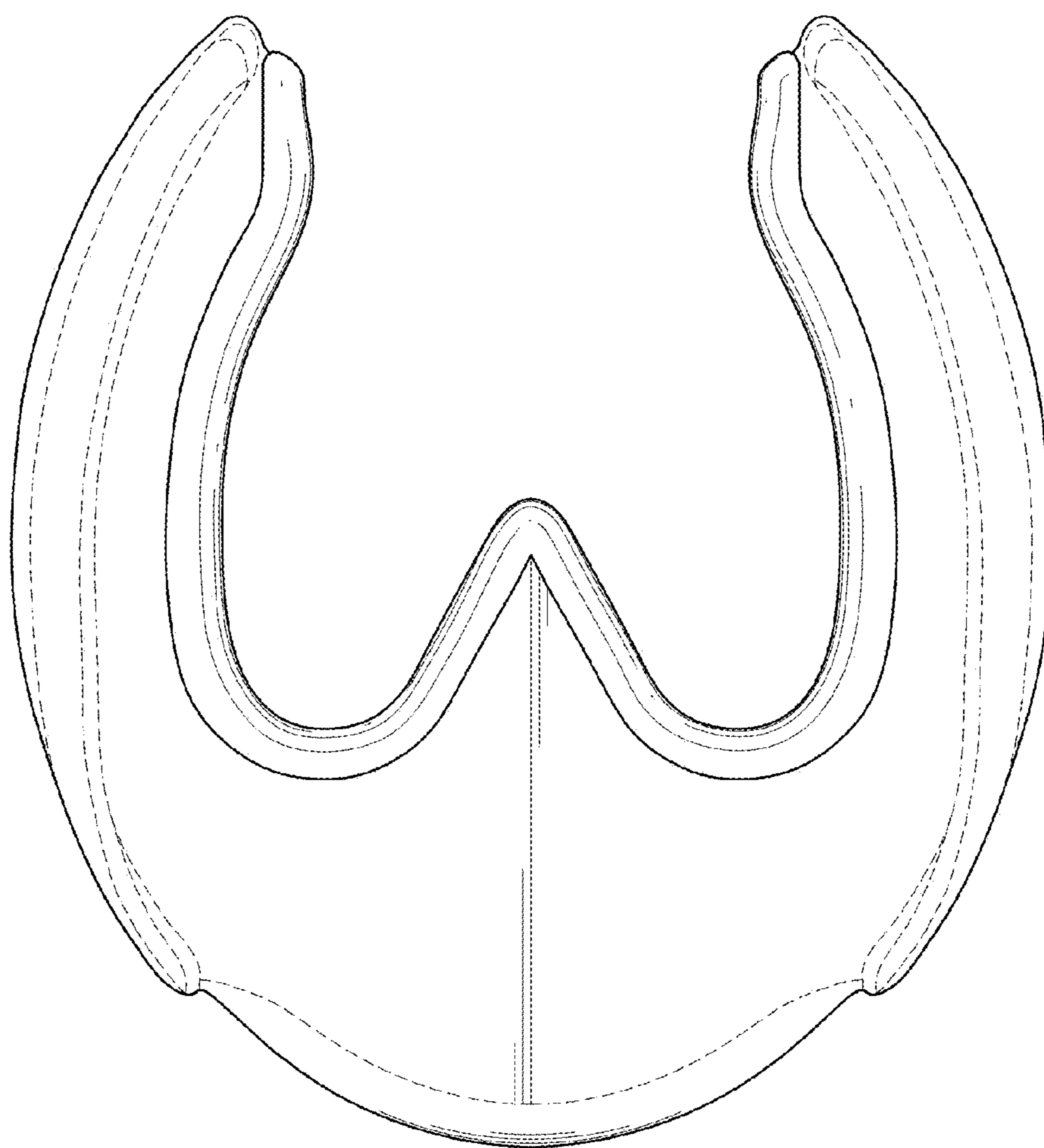
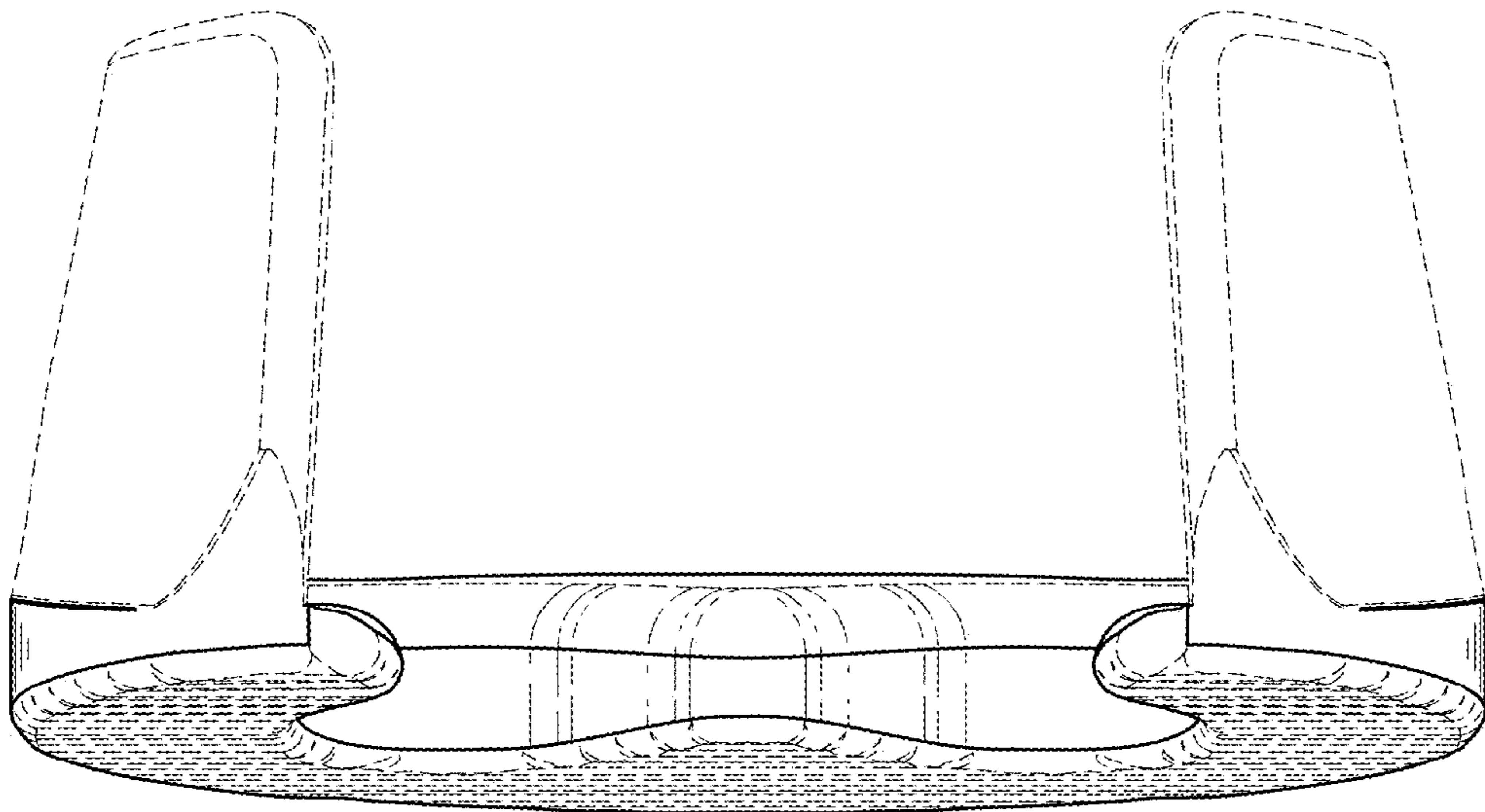
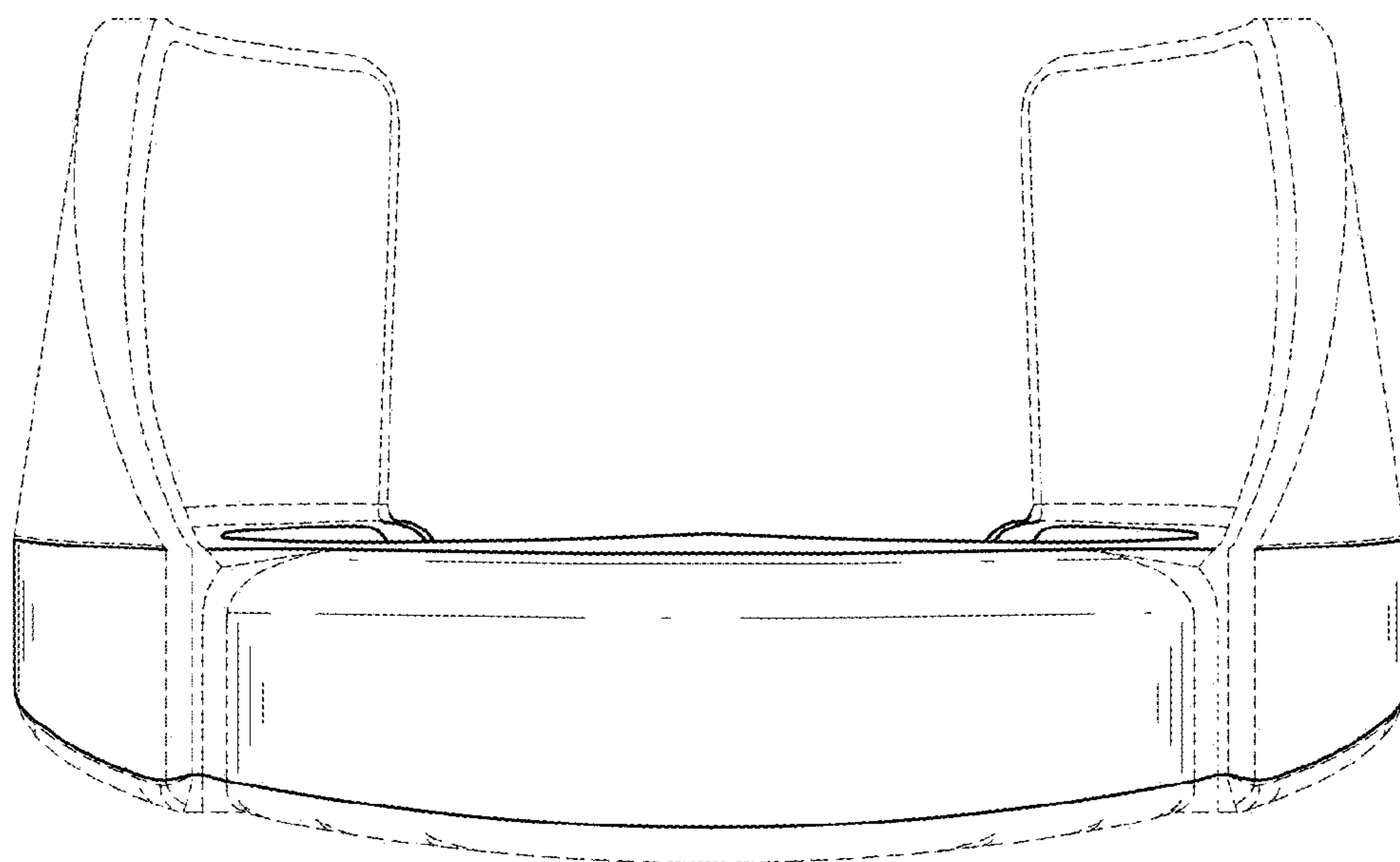

FIG. 4



*FIG. 5*



*FIG. 6*