



US00D732638S

(12) **United States Design Patent**
Fuller et al.

(10) **Patent No.:** **US D732,638 S**
(45) **Date of Patent:** **** Jun. 23, 2015**

(54) **WATER DISPLAY**

(71) Applicants: **Mark Fuller**, Sun Valley, CA (US);
Jules Moretti, Sun Valley, CA (US);
Peter Kopik, Sun Valley, CA (US)

(72) Inventors: **Mark Fuller**, Sun Valley, CA (US);
Jules Moretti, Sun Valley, CA (US);
Peter Kopik, Sun Valley, CA (US)

(**) Term: **14 Years**

(21) Appl. No.: **29/450,032**

(22) Filed: **Mar. 15, 2013**

(51) **LOC (10) Cl.** **23-01**

(52) **U.S. Cl.**
USPC **D23/201**

(58) **Field of Classification Search**
USPC D23/201; 239/17-21, DIG. 1; 40/406,
40/407, 439

See application file for complete search history.

(56) **References Cited**

U.S. PATENT DOCUMENTS

D208,755 S *	9/1967	Hruby	D23/201
D232,229 S *	7/1974	Hruby	D23/201
6,871,793 B2 *	3/2005	Rumens et al.	239/16
8,333,331 B1 *	12/2012	Fuller et al.	239/17

* cited by examiner

Primary Examiner — Robin V Webster

(74) *Attorney, Agent, or Firm* — Maceiko IP

(57) **CLAIM**

The ornamental design for a water display, as shown and described.

DESCRIPTION

FIG. 1 is a perspective view of a water display; FIGS. 1A, 1B, 1C, 1D, and 1E, respectively, are top, front, rear, left, and right views corresponding to the perspective view of FIG. 1;

FIG. 2 is another perspective view thereof;

FIG. 3 is another perspective view thereof;

FIG. 4 is another perspective view thereof;

FIG. 5 is another perspective view thereof;

FIG. 6 is another perspective view thereof;

FIG. 7 is another perspective view thereof;

FIG. 8 is another perspective view thereof; and,

FIG. 9 is another perspective view thereof.

The broken line showing of the foundation from which the water display emanates is included for the purpose of illustrating and forms no part of the claimed design.

The process or period in which the fountain transitions from one state to another forms no part of the claimed design.

1 Claim, 10 Drawing Sheets

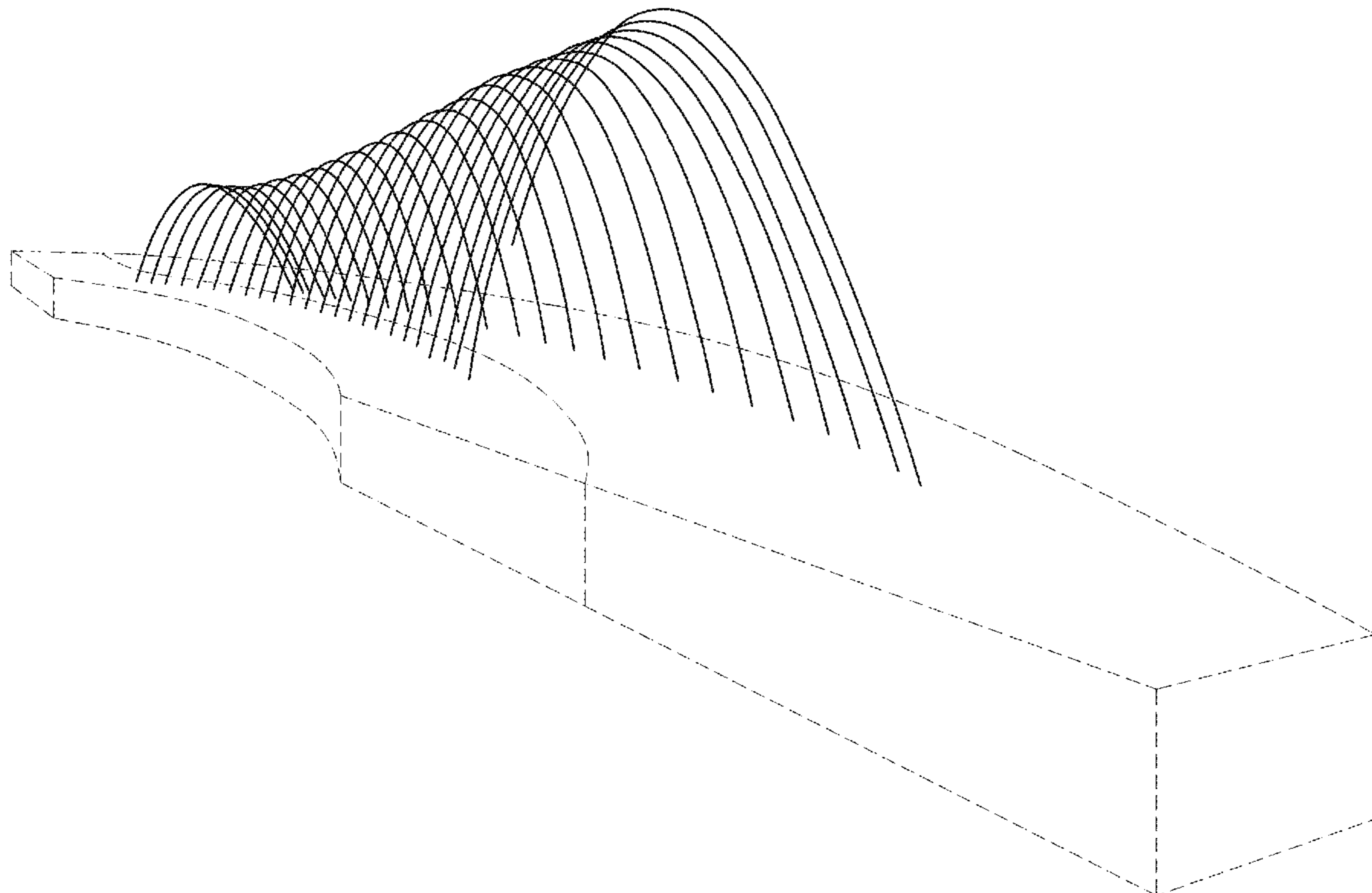

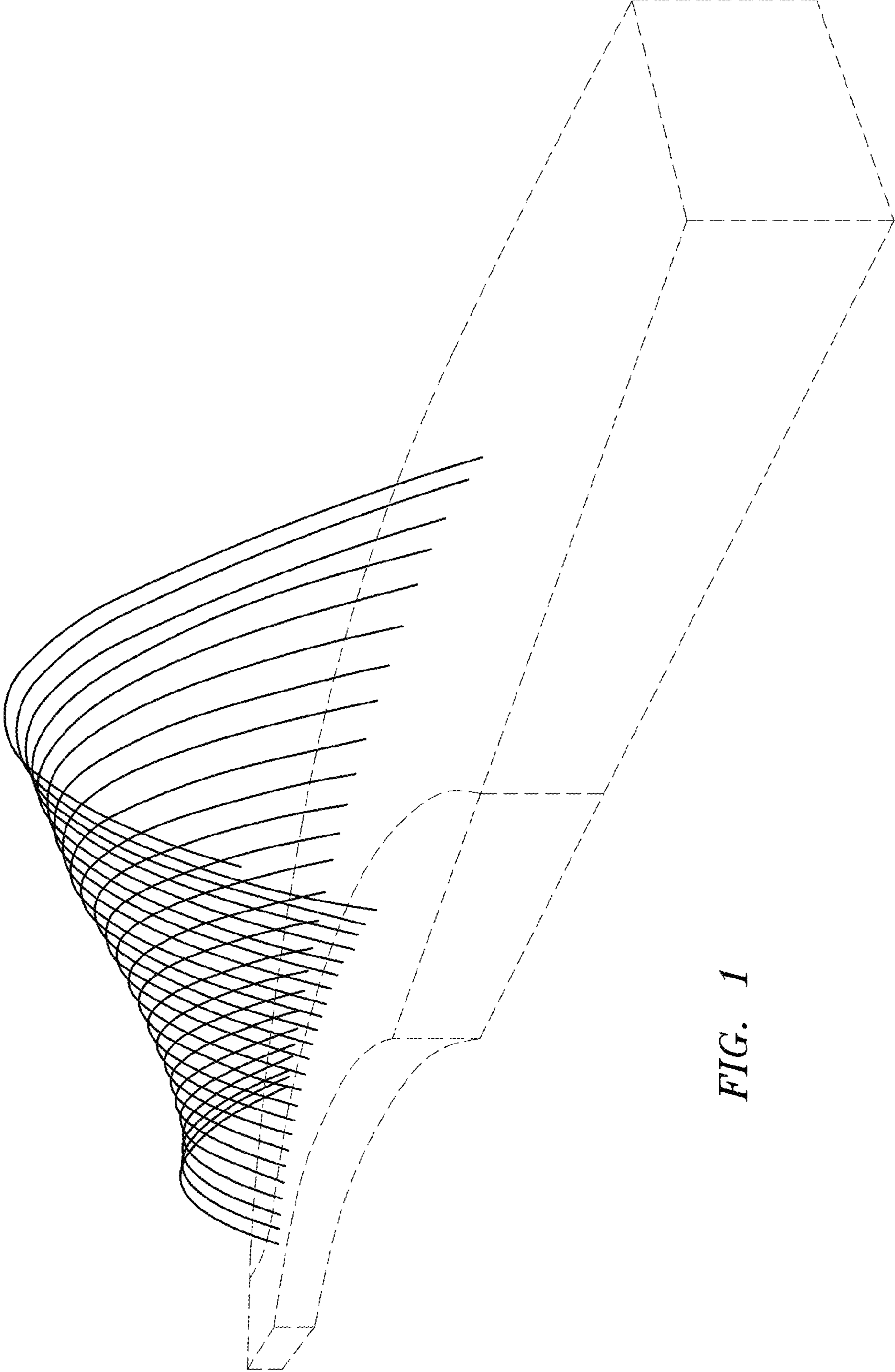

FIG. 1

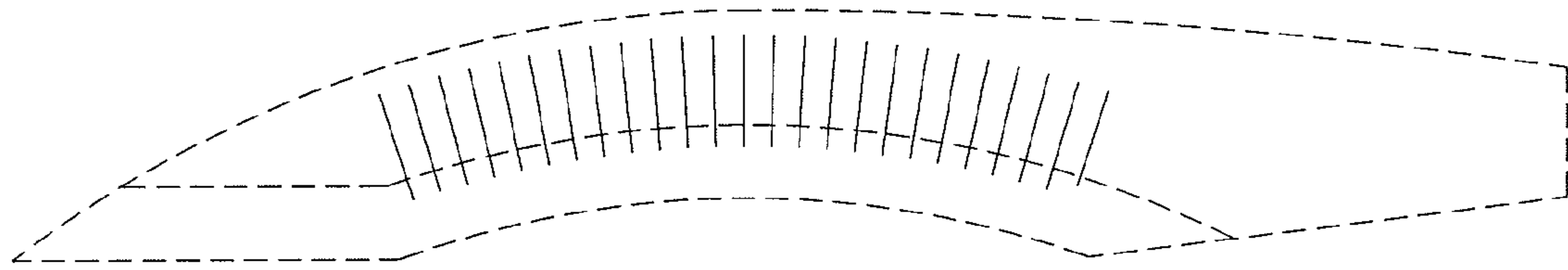

FIG. 1A

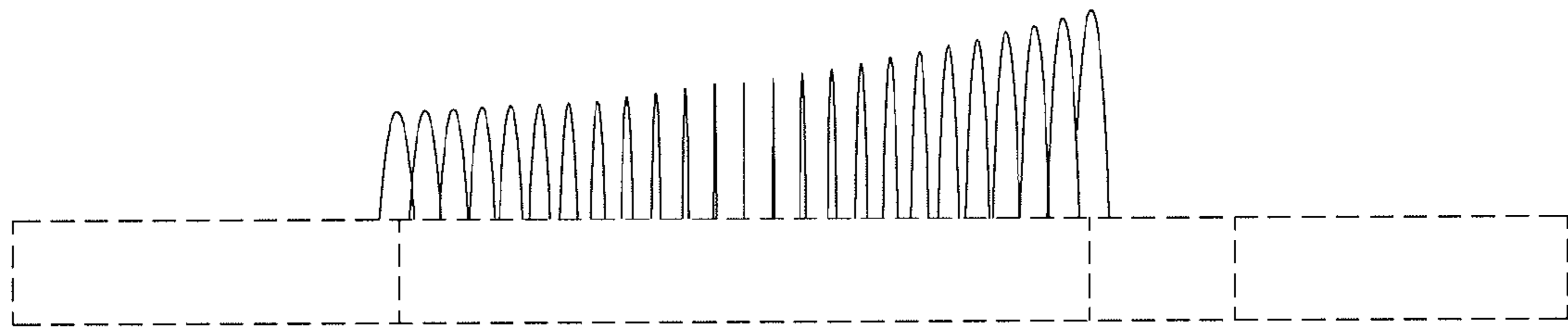

FIG. 1B

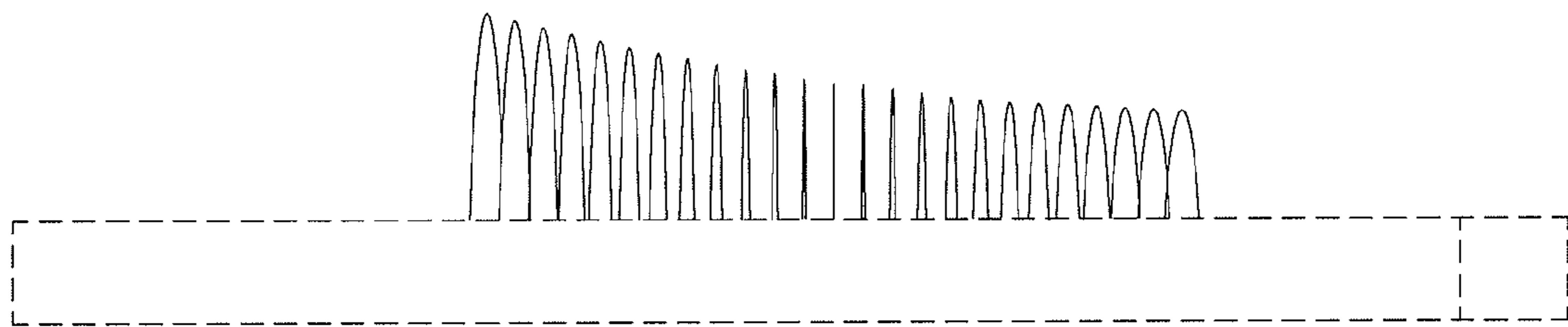

FIG. 1C

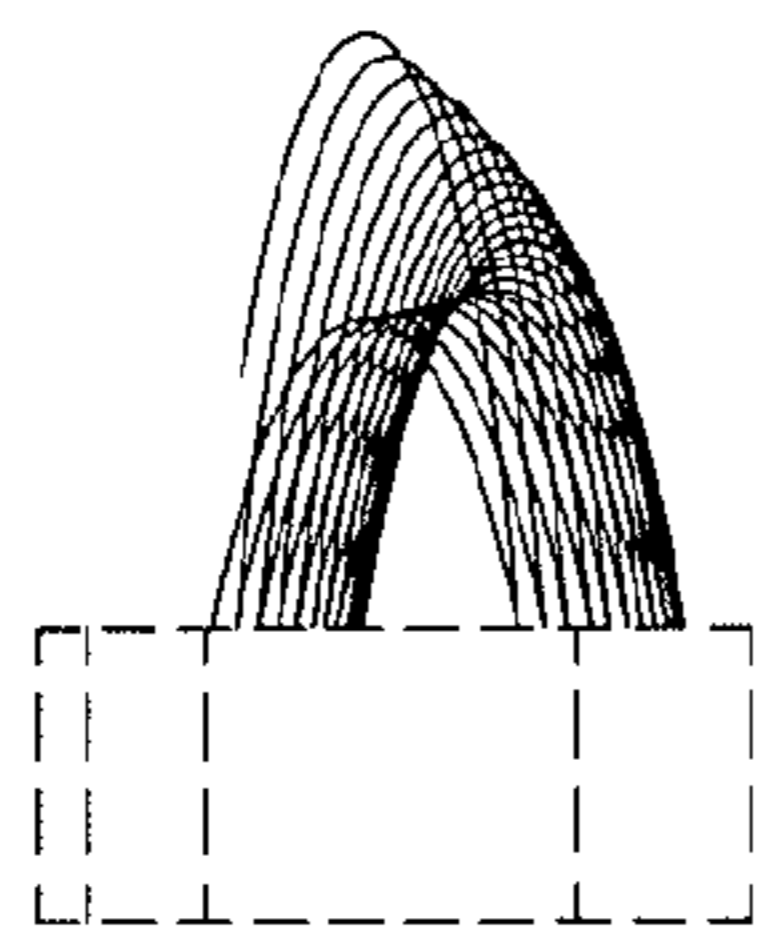

FIG. 1D

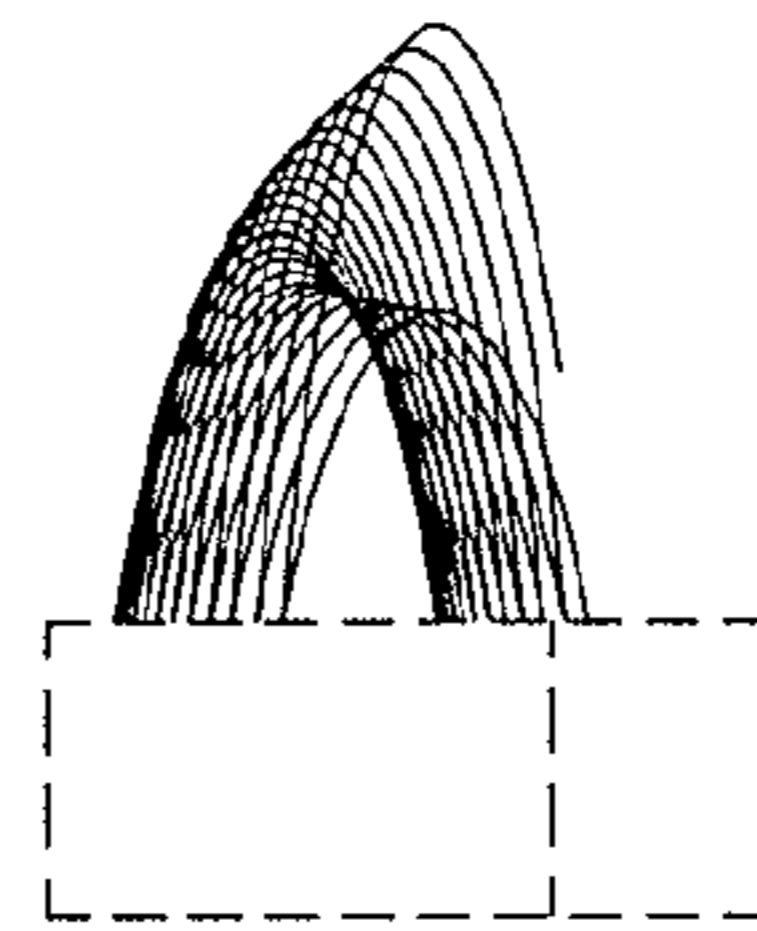

FIG. 1E

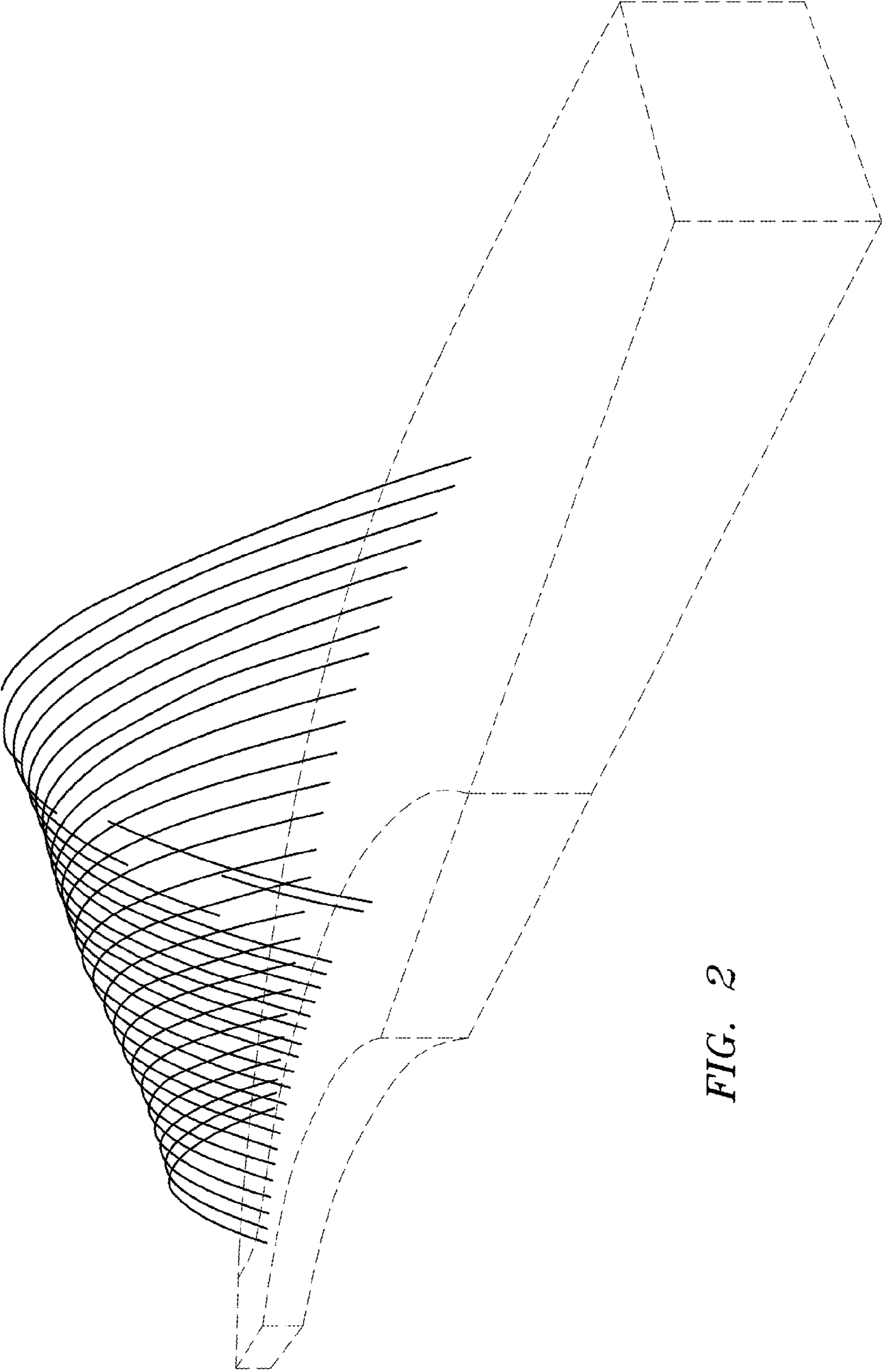

FIG. 2

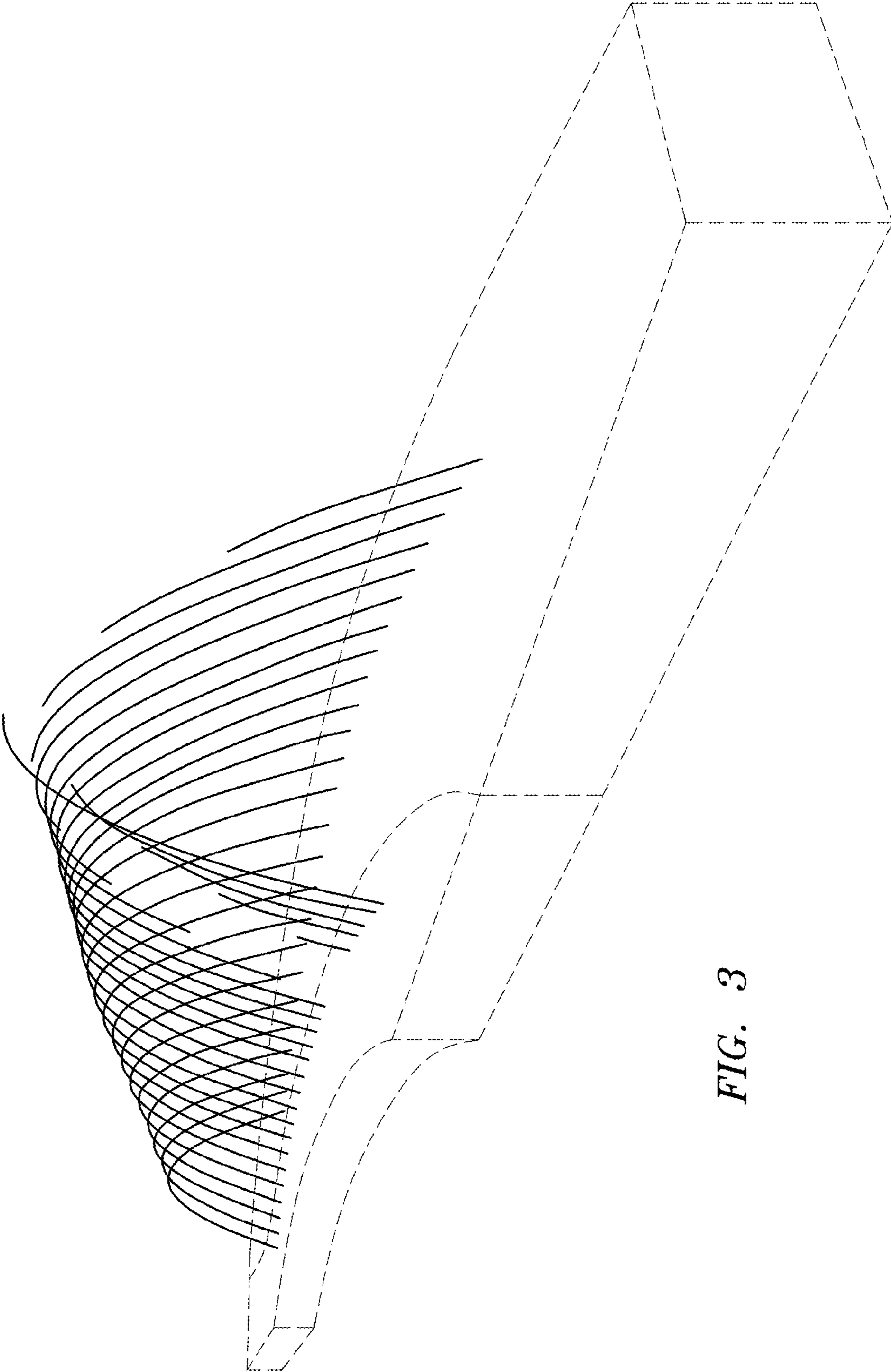

FIG. 3

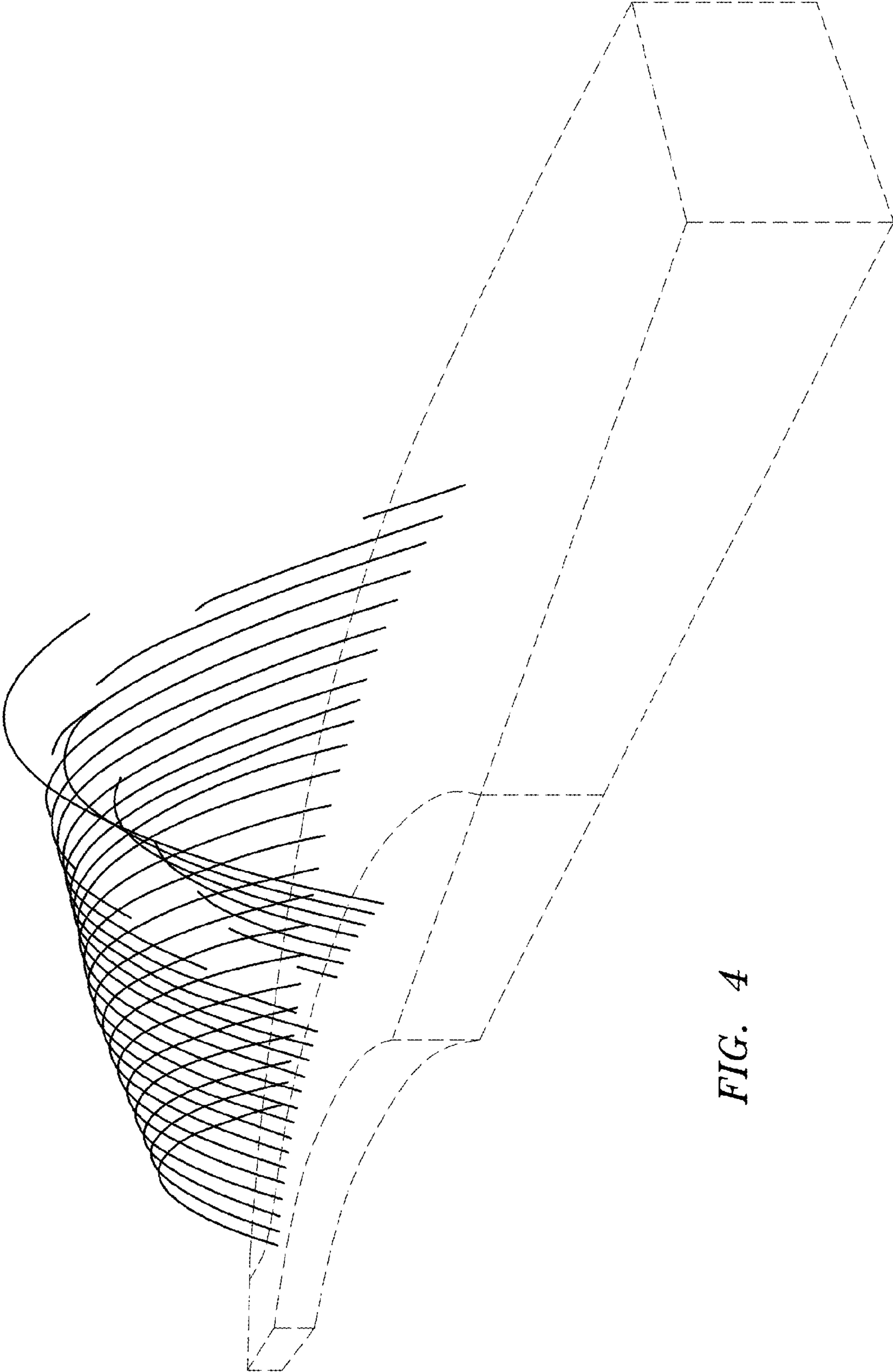

FIG. 4

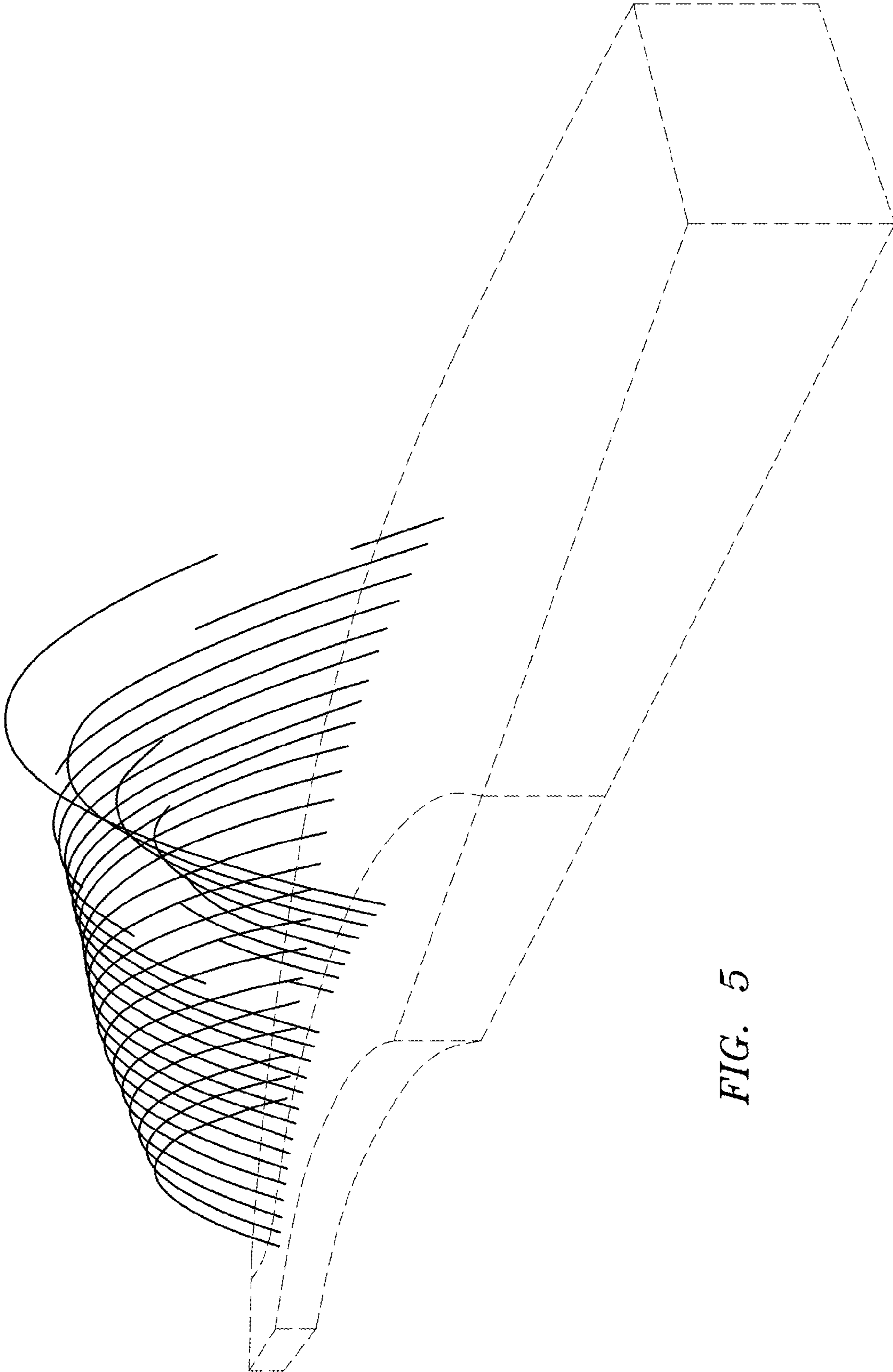

FIG. 5

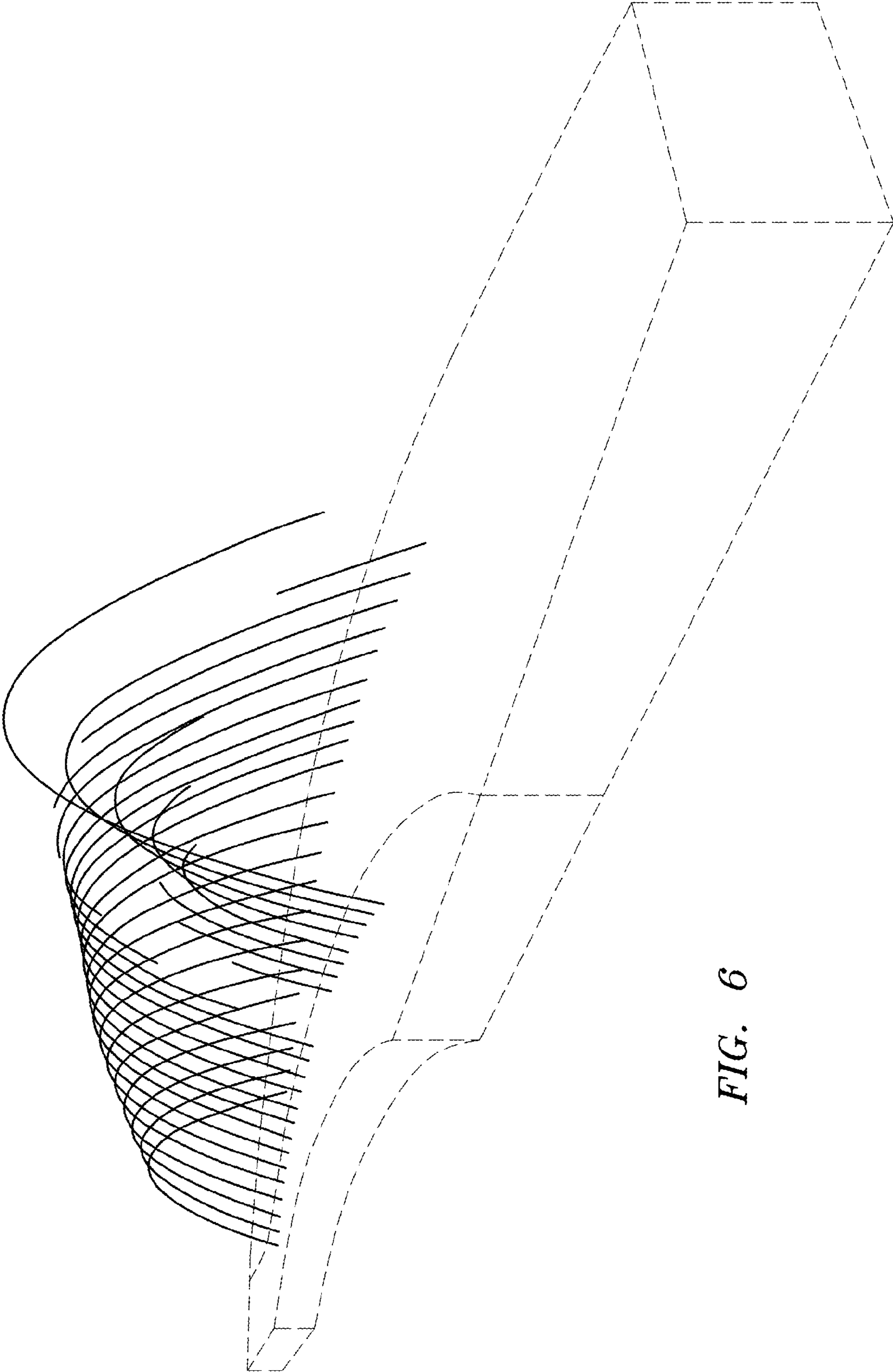

FIG. 6

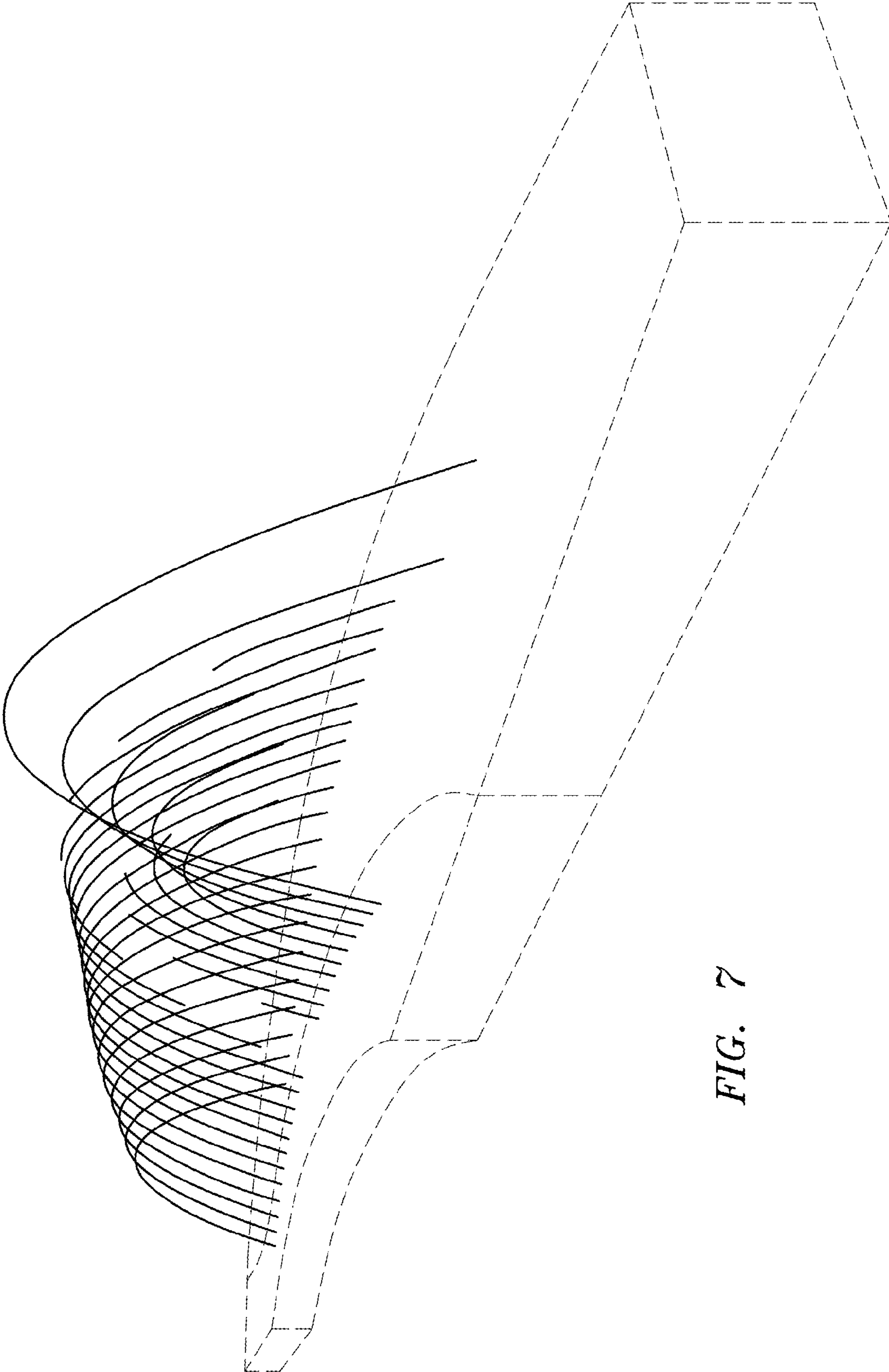

FIG. 7

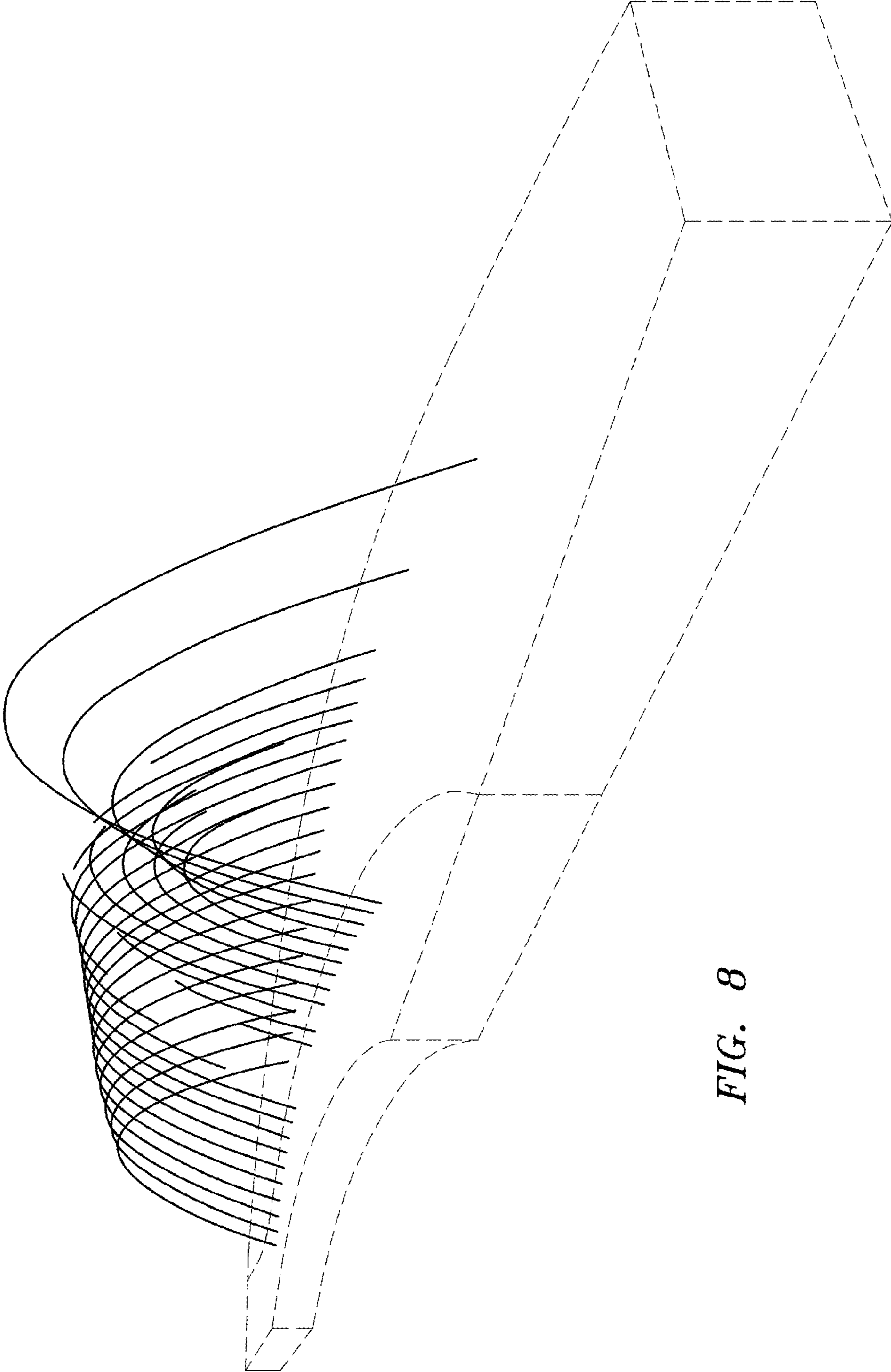

FIG. 8

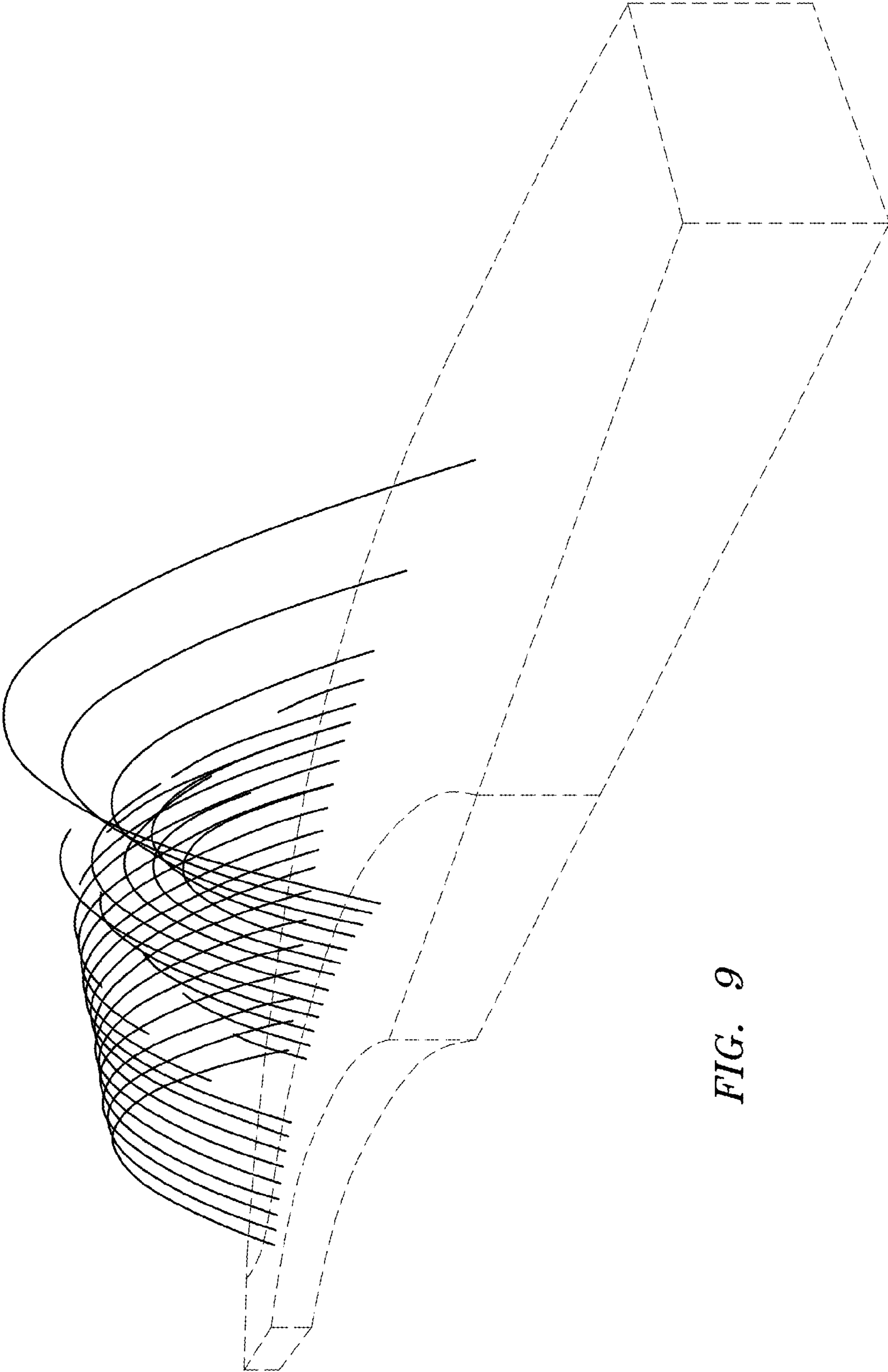

FIG. 9