



US00D732528S

(12) **United States Design Patent**
Kim et al.

(10) **Patent No.:** **US D732,528 S**
(45) **Date of Patent:** **** Jun. 23, 2015**

(54) **ELECTRONIC DEVICE**

(71) Applicant: **Samsung Electronics Co., Ltd,**
Suwon-Si (KR)

(72) Inventors: **Hyun Jin Kim**, Seoul (KR); **Ji yeon Kwak**, Seoul (KR); **Joon Kyu Seo**, Seoul (KR)

(73) Assignee: **Samsung Electronics Co., Ltd.,**
Suwon-si (KR)

(**) Term: **14 Years**

(21) Appl. No.: **29/465,095**

(22) Filed: **Aug. 23, 2013**

(30) **Foreign Application Priority Data**

Feb. 23, 2013 (KR) 30-2013-0009576

(51) **LOC (10) Cl.** **14-02**

(52) **U.S. Cl.**
USPC **D14/344**

(58) **Field of Classification Search**

USPC D14/341, 342, 343, 344, 345, 346, 347,
D14/420, 426, 427; D10/30, 31, 32, 37, 38,
D10/39, 65; 368/281, 282, 294, 295, 296;
455/100; 361/679.03; 379/433.1;
D11/3

See application file for complete search history.

(56) **References Cited**

U.S. PATENT DOCUMENTS

4,906,025 A * 3/1990 Schreindl 281/45
D363,290 S * 10/1995 Kim D14/248
D406,142 S * 2/1999 Meurer D14/218
D500,308 S * 12/2004 Honda D14/218
D529,469 S * 10/2006 Rose et al. D14/138 R
D549,221 S * 8/2007 Yagi D14/218

D552,586 S * 10/2007 Kim D14/138 AD
D556,194 S * 11/2007 Rambosek et al. D14/480.3
D565,427 S * 4/2008 Ellner et al. D10/31
D576,501 S * 9/2008 Tang D10/32
D589,374 S * 3/2009 Tang D10/32
D633,399 S * 3/2011 Zinder D10/31
D646,686 S * 10/2011 Cacioppo et al. D14/453
D656,502 S * 3/2012 Cacioppo et al. D14/453
D661,275 S * 6/2012 Roka D14/138 R
D703,069 S * 4/2014 Adams et al. D10/31
D711,002 S * 8/2014 Ohnemus et al. D24/186
D715,248 S * 10/2014 Agarwal D14/138 G
D717,261 S * 11/2014 Yun et al. D14/138 R
D721,701 S * 1/2015 Al-Nasser D14/344

* cited by examiner

Primary Examiner — Barbara Fox

Assistant Examiner — Chelsea Sealey

(74) *Attorney, Agent, or Firm* — NSIP Law

(57) **CLAIM**

The ornamental design for an electronic device, as shown and described.

DESCRIPTION

FIG. 1 is a front perspective view of an electronic device showing our new design;

FIG. 2 is a front view thereof;

FIG. 3 is a rear view thereof;

FIG. 4 is a left-side view thereof;

FIG. 5 is a right-side view thereof;

FIG. 6 is a top view thereof;

FIG. 7 is a bottom view thereof; and,

FIG. 8 is a perspective view of the electronic device shown in an open position.

The broken lines are for environmental purposes only and form no part of the claimed design.

The broken lines indicate portions of the electronic device that form no part of the claimed design.

1 Claim, 8 Drawing Sheets

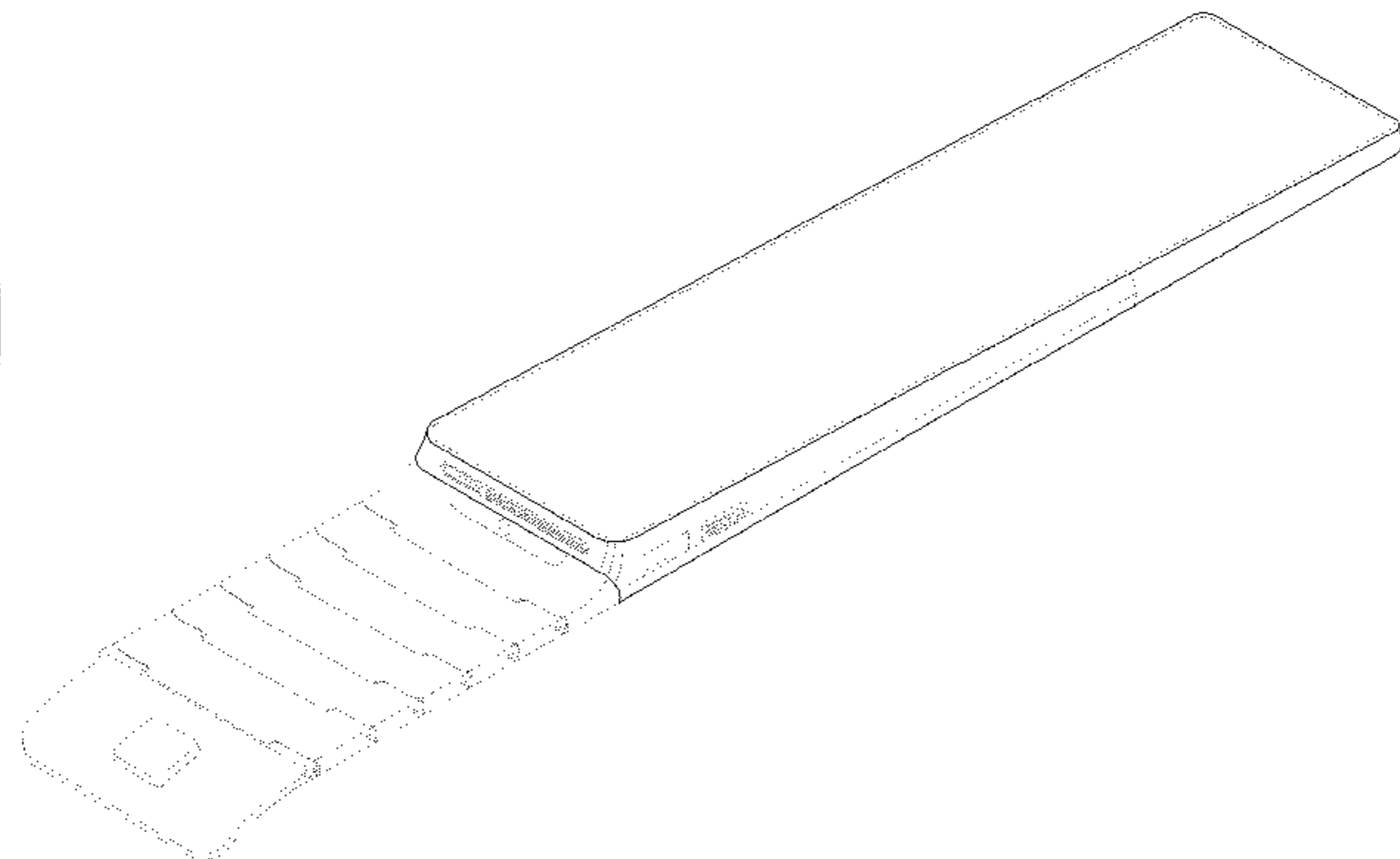
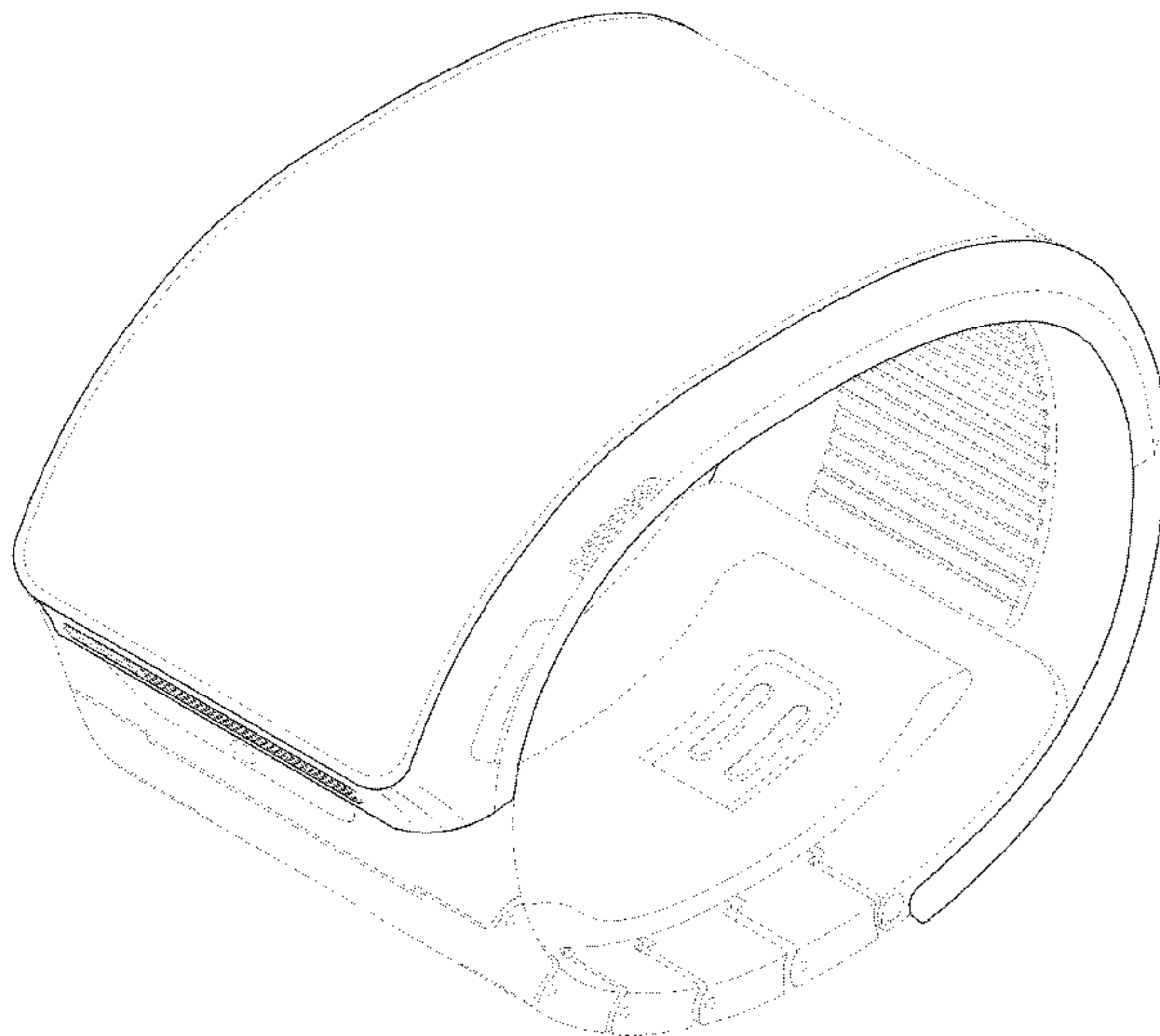

FIG. 1

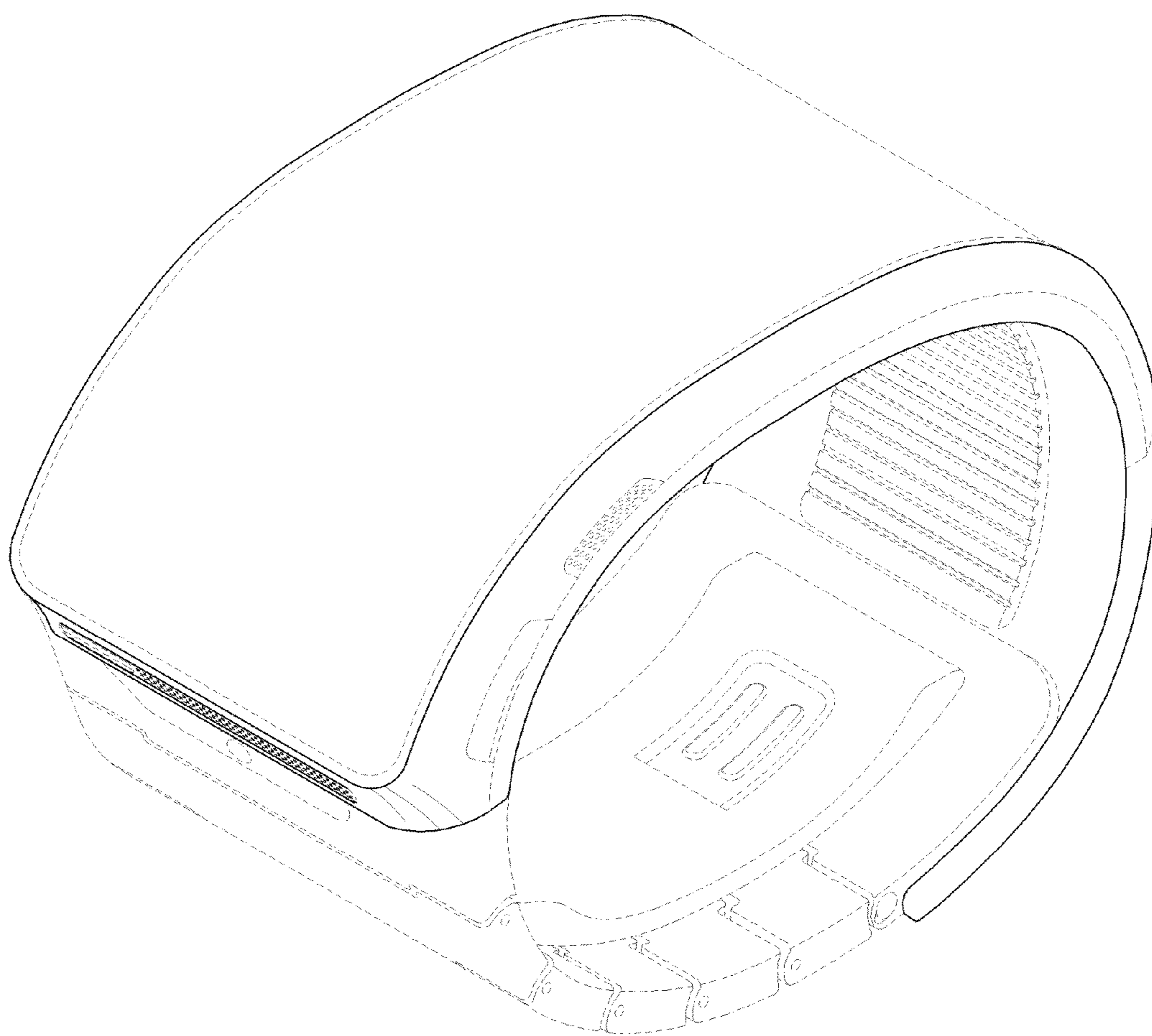

FIG. 2

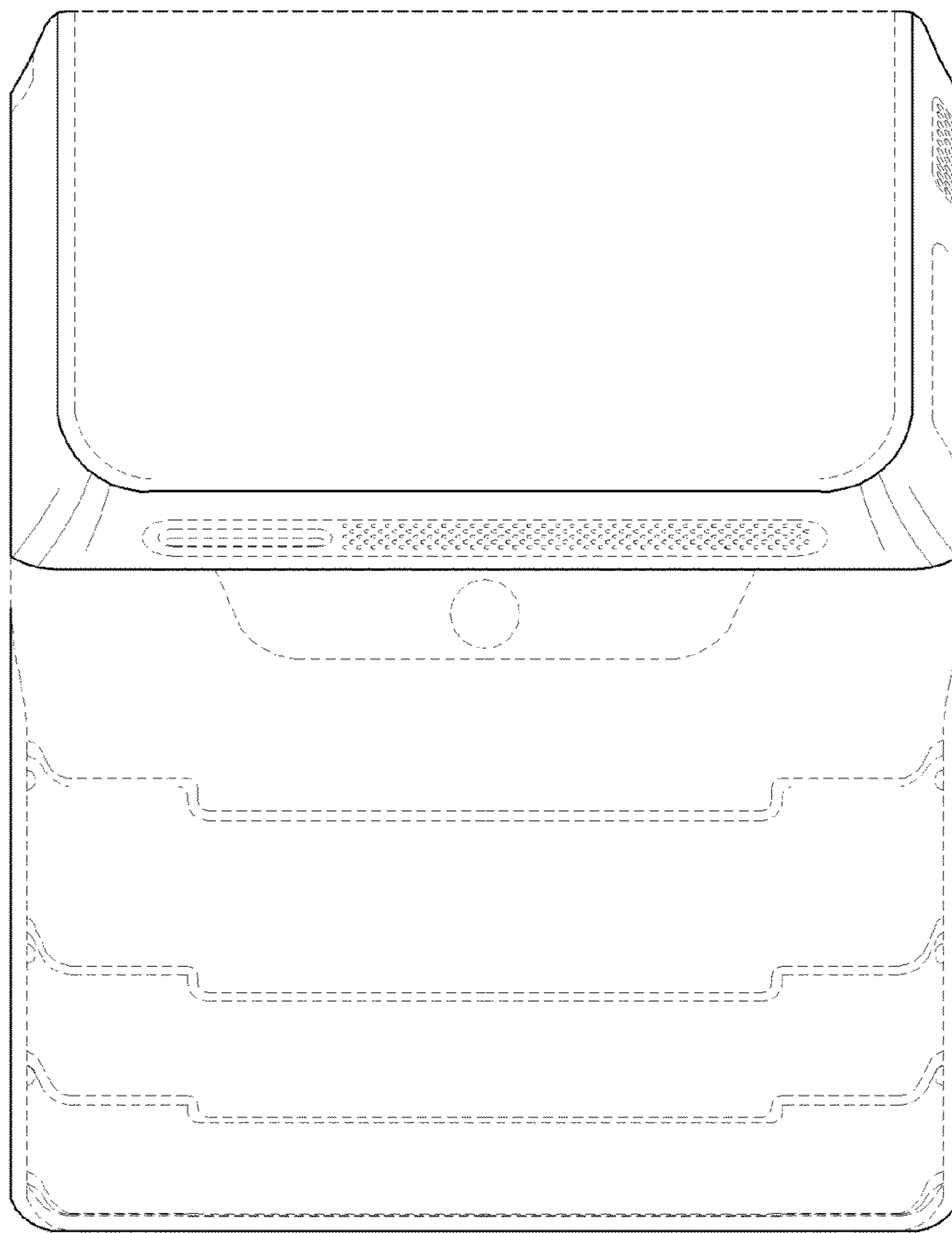

FIG. 3

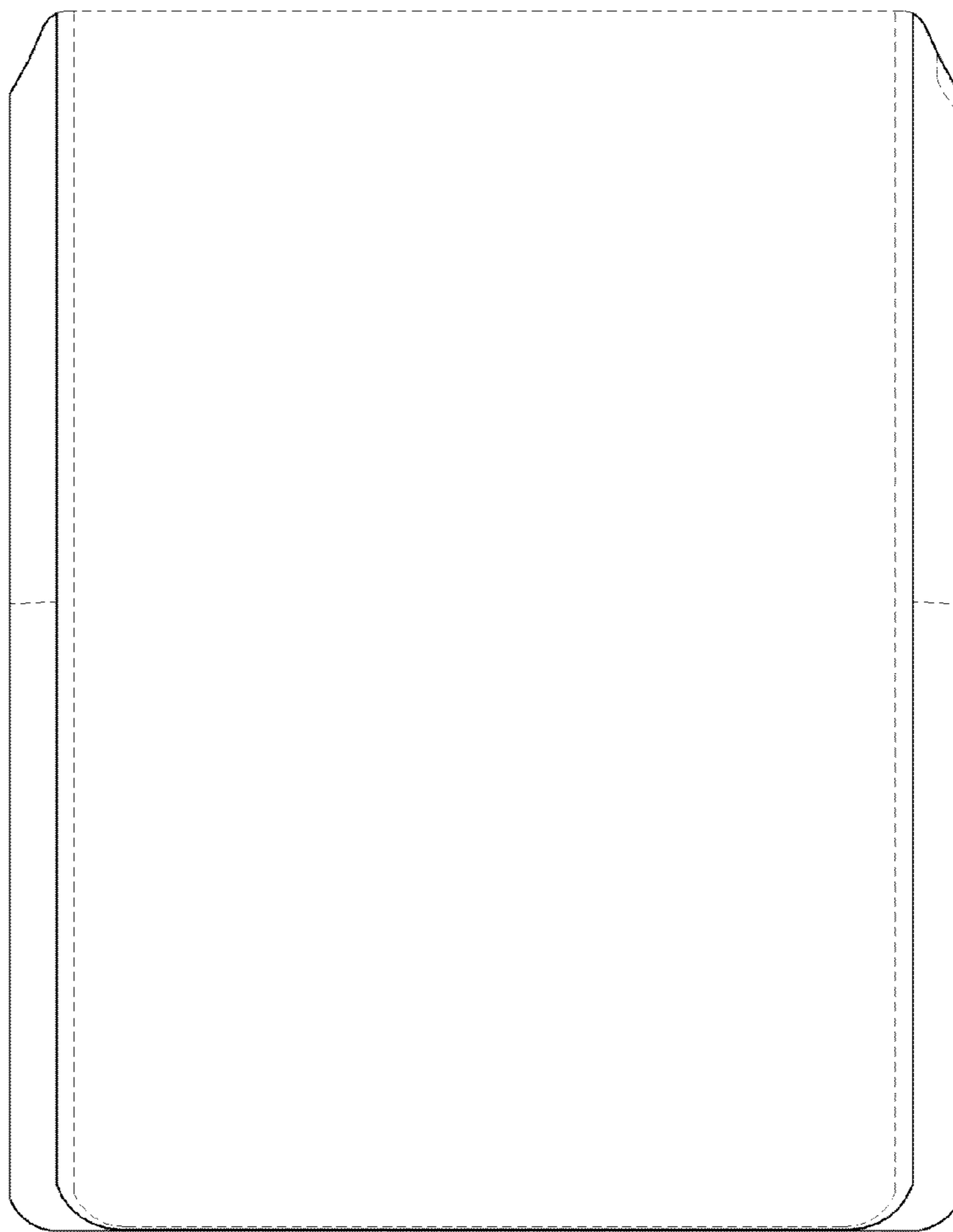

FIG. 4

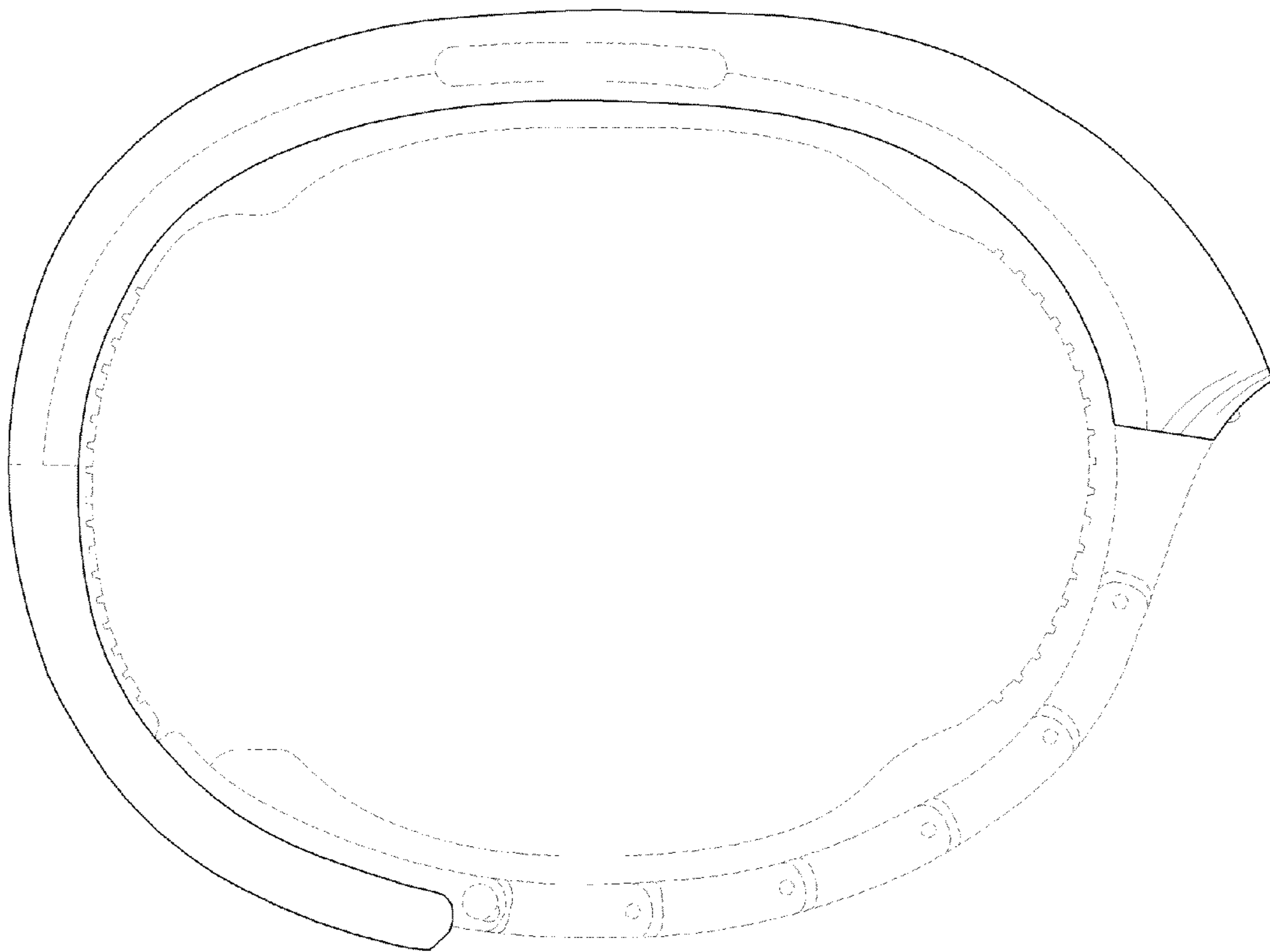

FIG. 5

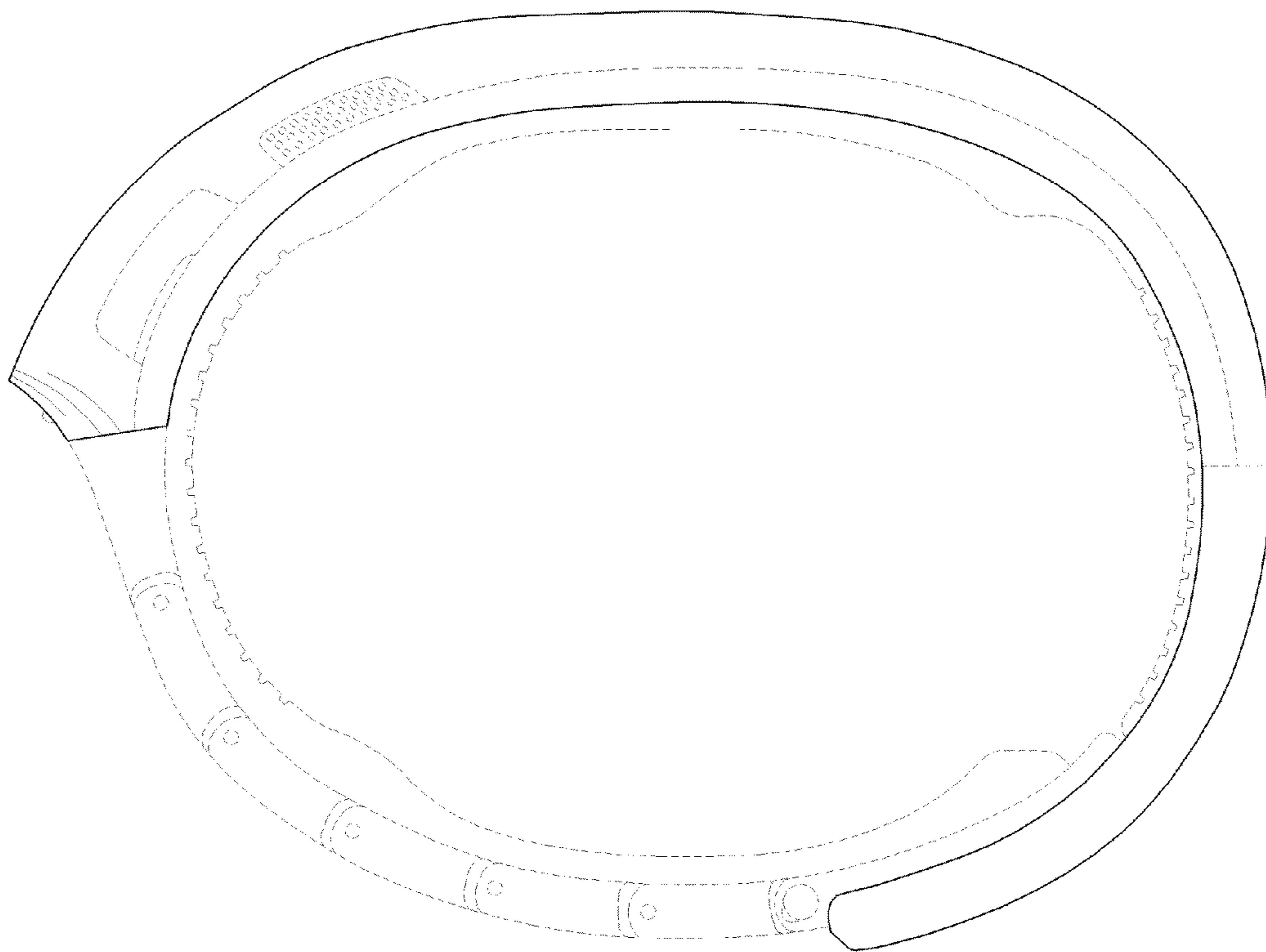

FIG. 6

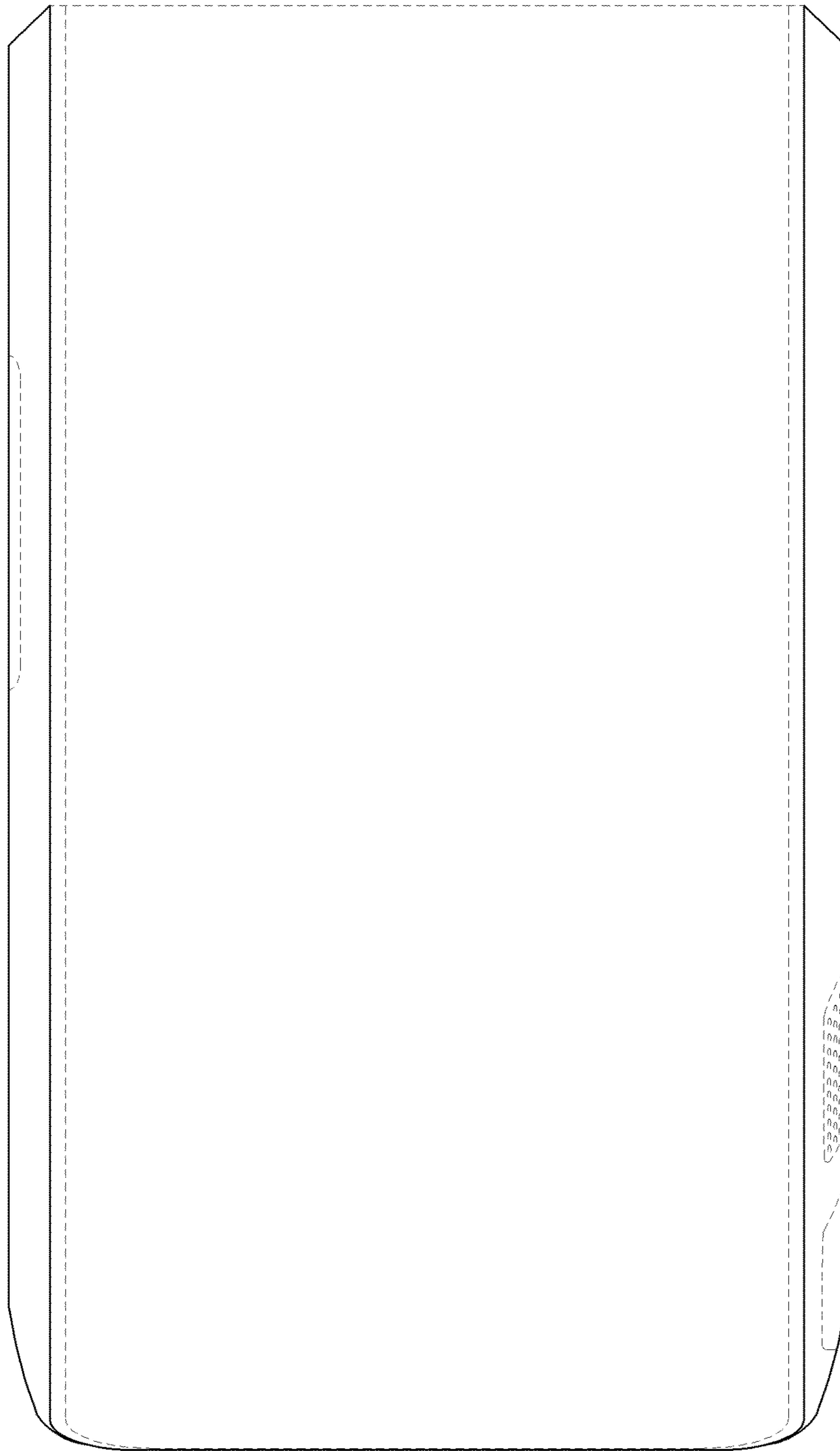

FIG. 7

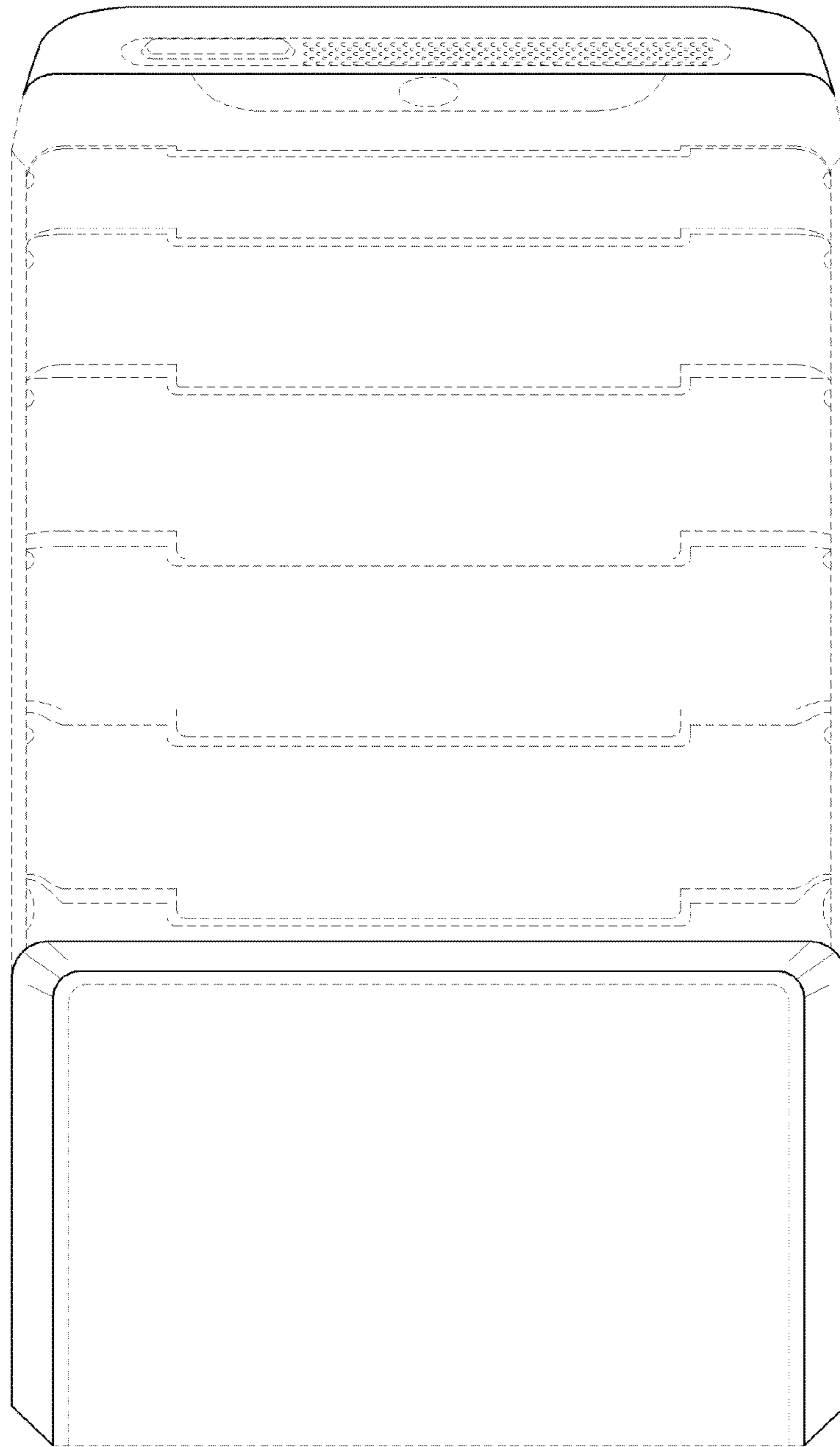

FIG. 8

