



US00D732477S

(12) **United States Design Patent**  
**Habirov et al.**

(10) **Patent No.:** **US D732,477 S**

(45) **Date of Patent:** **\*\* Jun. 23, 2015**

(54) **PLUG BLOCK COMPRISING A PLURALITY OF MODULAR PLUGS**

(74) *Attorney, Agent, or Firm* — Roberts Mlotkowski Safran & Cole, P.C.; David S. Safran

(71) Applicant: **Phoenix Contact GmbH & Co. KG**,  
Blomberg (DE)

(57) **CLAIM**  
The ornamental design for a plug block comprising a plurality of modular plugs, as shown in the accompanying drawings.

(72) Inventors: **Dennis Habirov**, Bielefeld (DE);  
**Christian Kloppenburg**, Büren  
Wewelsburg (DE); **Olaf Schyrocki**, Bad  
Pyrmont (DE)

**DESCRIPTION**

(73) Assignee: **Phoenix Contact GmbH & Co. KG**,  
Blomberg (DE)

FIG. 1 is a bottom plan view of a first embodiment of a plug block comprising a plurality of modular plus showing our new design;

(\*\*) Term: **14 Years**

FIG. 2 is a front elevation view thereof;

(21) Appl. No.: **29/439,654**

FIG. 3 is a rear elevation view thereof;

(22) Filed: **Dec. 13, 2012**

FIG. 4 is a top plan view thereof;

(30) **Foreign Application Priority Data**

FIG. 5 is a top, front and right side perspective view thereof;

Jun. 13, 2012 (EM) ..... 002057463

FIG. 6 is a bottom plan view of a second embodiment of a plug block comprising a plurality of modular plus showing our new design;

(51) **LOC (10) Cl.** ..... **13-03**

FIG. 7 is a front elevation view thereof;

(52) **U.S. Cl.**

FIG. 8 is a rear elevation view thereof;

USPC ..... **D13/147**

FIG. 9 is a top plan view thereof;

(58) **Field of Classification Search**

FIG. 10 is a top, front and right side perspective view thereof;

USPC ..... D13/147, 154, 158, 184, 199, 133, 146

FIG. 11 is a bottom plan view of a third embodiment of a plug block comprising a plurality of modular plus showing our new design;

CPC ..... H01R 4/26; H01R 4/24; H01R 9/26;

FIG. 12 is a front elevation view thereof;

H01R 11/20; H01R 11/22; H01R 13/62;

FIG. 13 is a rear elevation view thereof;

H01R 31/08; H01R 33/26; H01H 21/54

FIG. 14 is a top plan view thereof;

See application file for complete search history.

FIG. 15 is a top, front and right side perspective view thereof;

(56) **References Cited**

FIG. 16 is a bottom plan view of a fourth embodiment of a plug block comprising a plurality of modular plus showing our new design;

**U.S. PATENT DOCUMENTS**

FIG. 17 is a front elevation view thereof;

D281,415 S \* 11/1985 Nusse ..... D13/147

FIG. 18 is a rear elevation view thereof;

D325,373 S \* 4/1992 Kuzuno et al. .... D13/147

FIG. 19 is a top plan view thereof;

D569,347 S \* 5/2008 Conn ..... D13/154

FIG. 20 is a top, front and right side perspective view thereof;

*Primary Examiner* — Daniel Bui

and,

*Assistant Examiner* — Sanjeev Paul

FIGS. 21 & 22 are right and left side elevation views, respectively, of all embodiment.

**1 Claim, 21 Drawing Sheets**

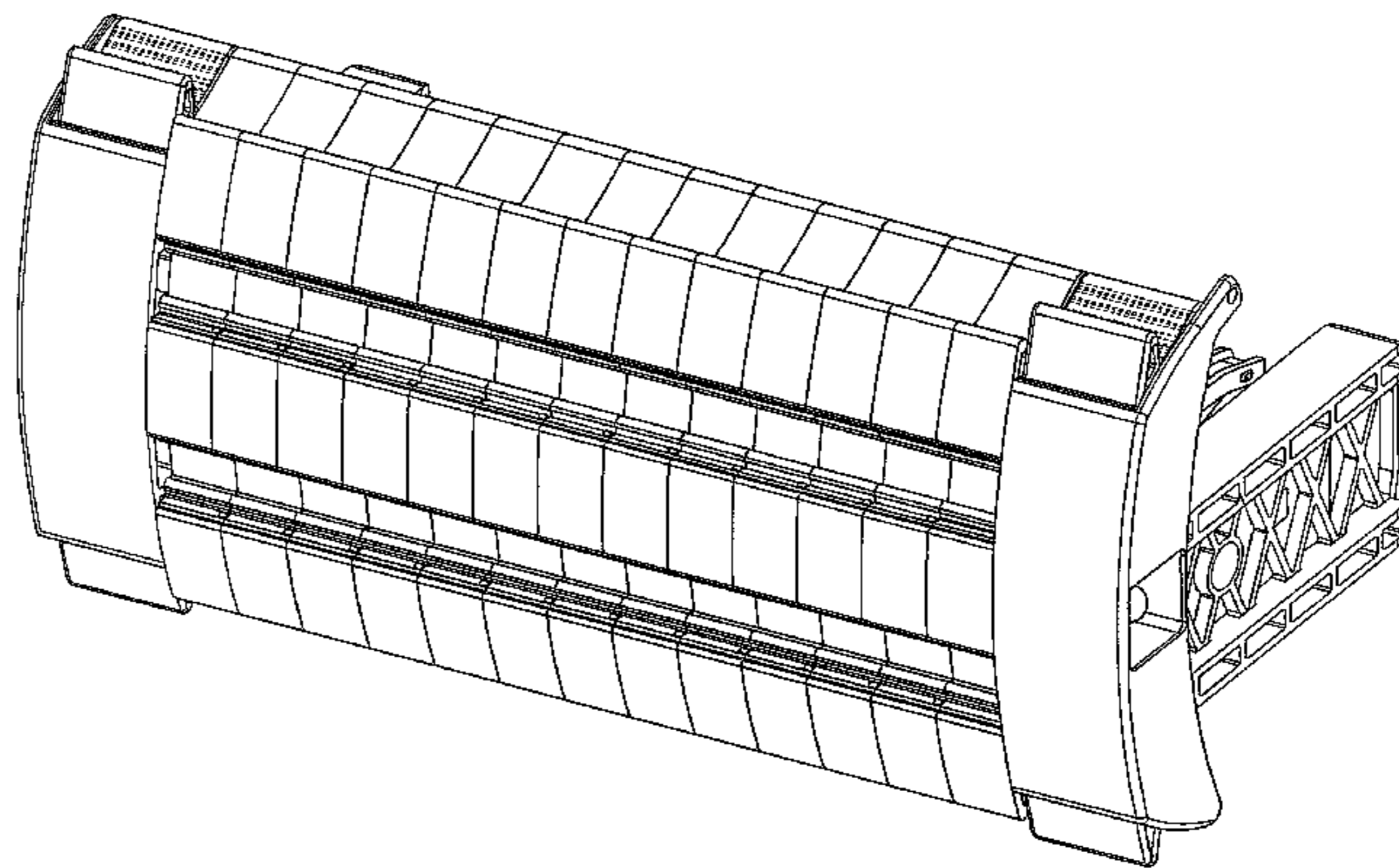
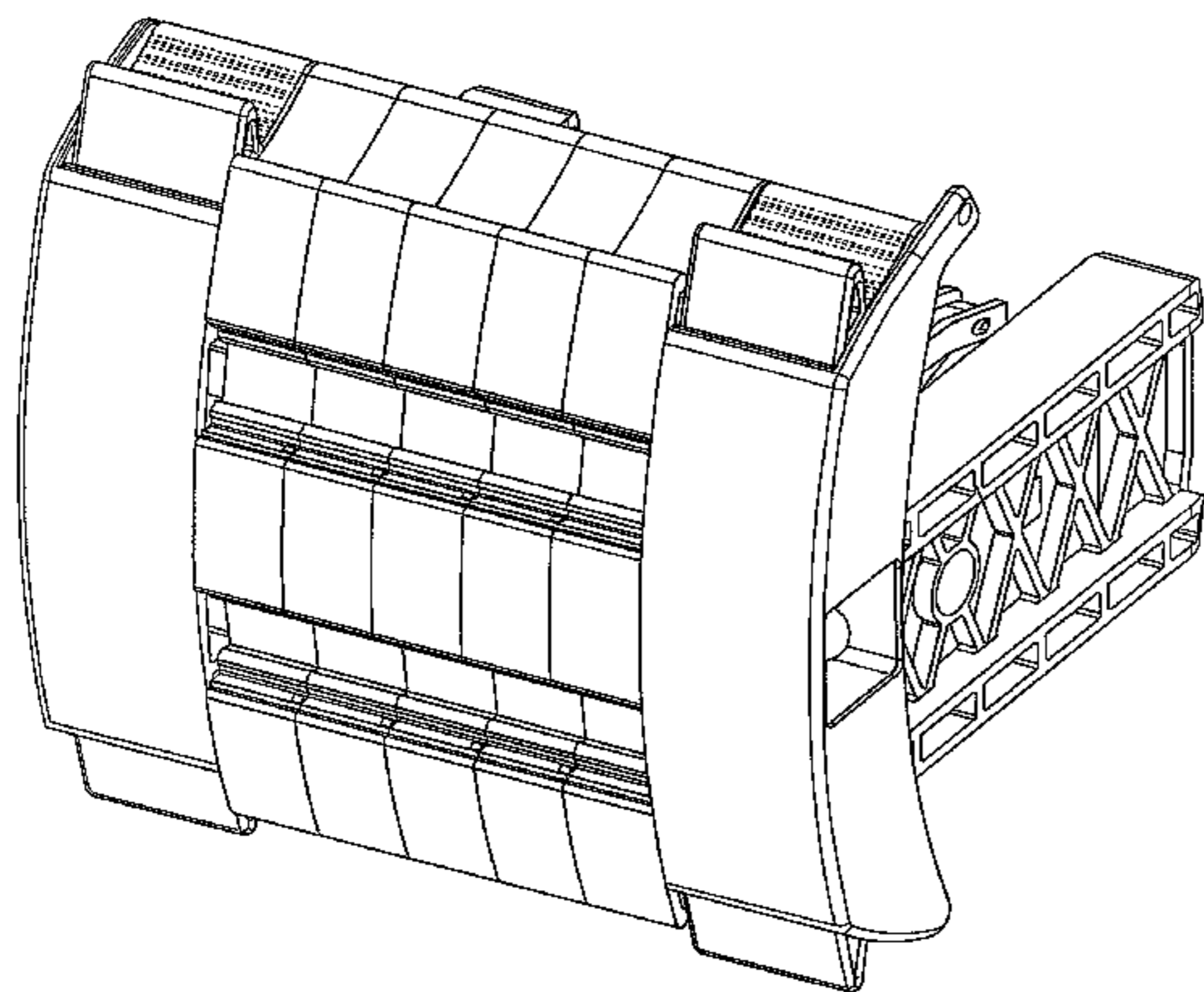

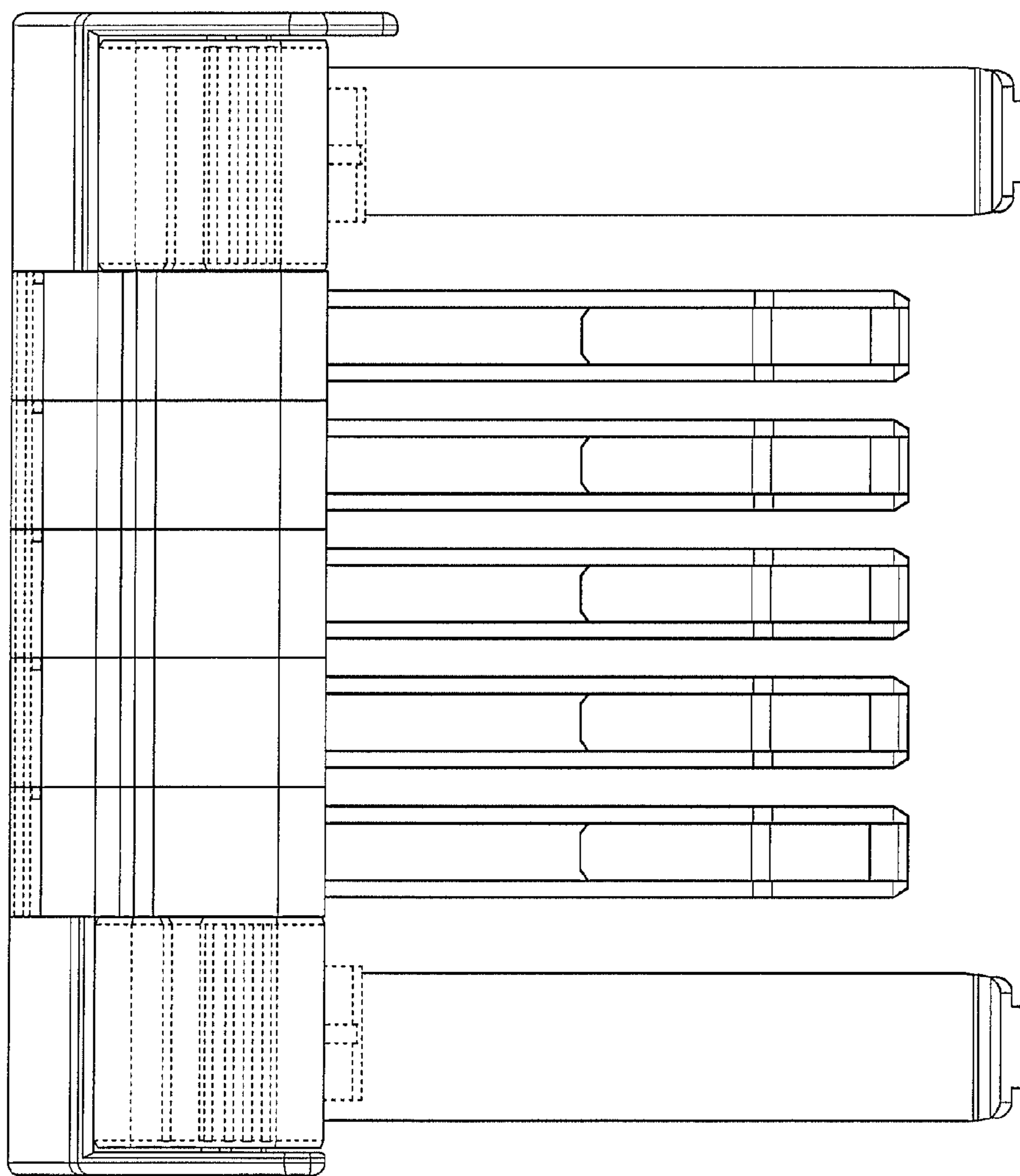

FIG. 1

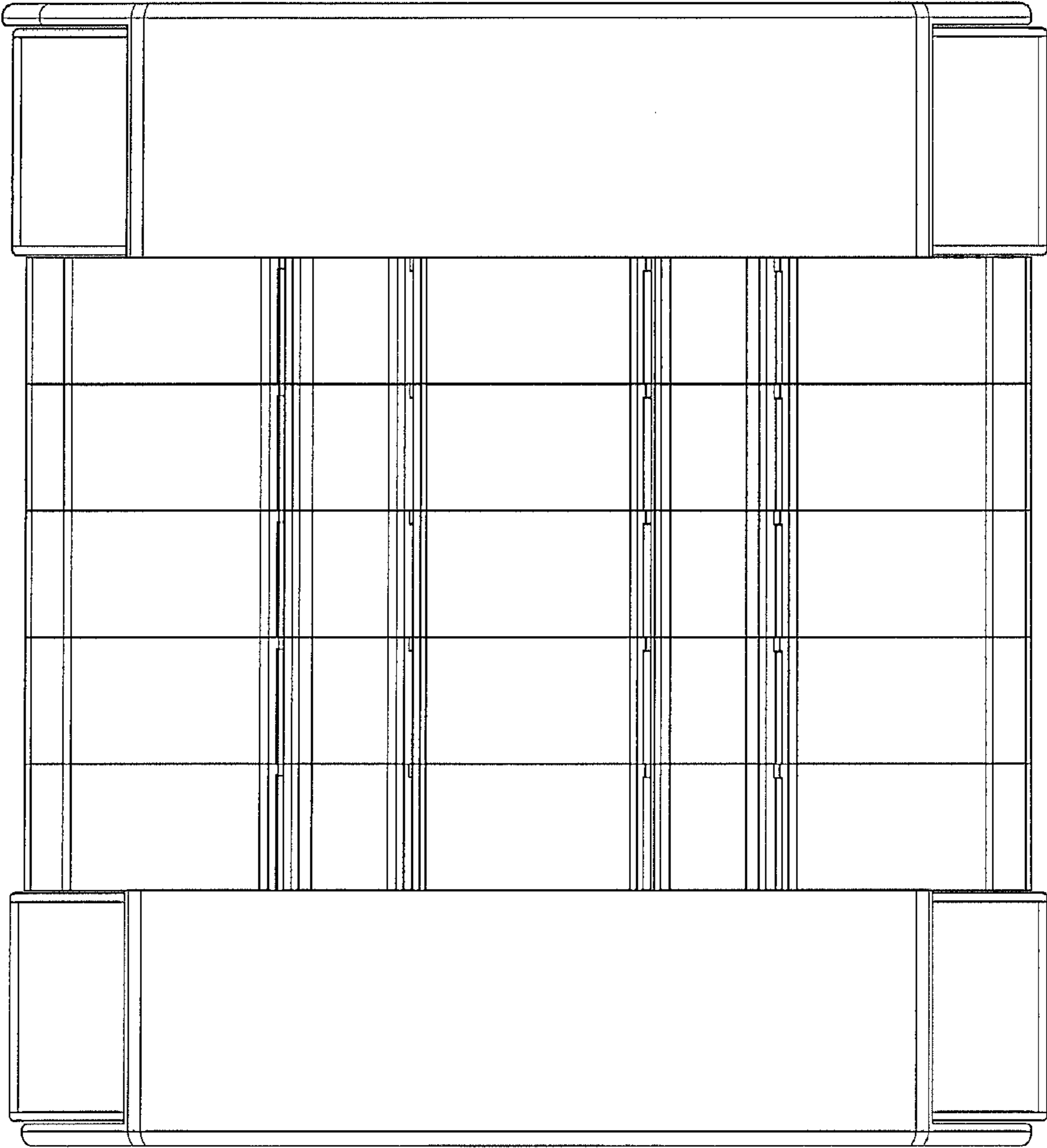

FIG. 2

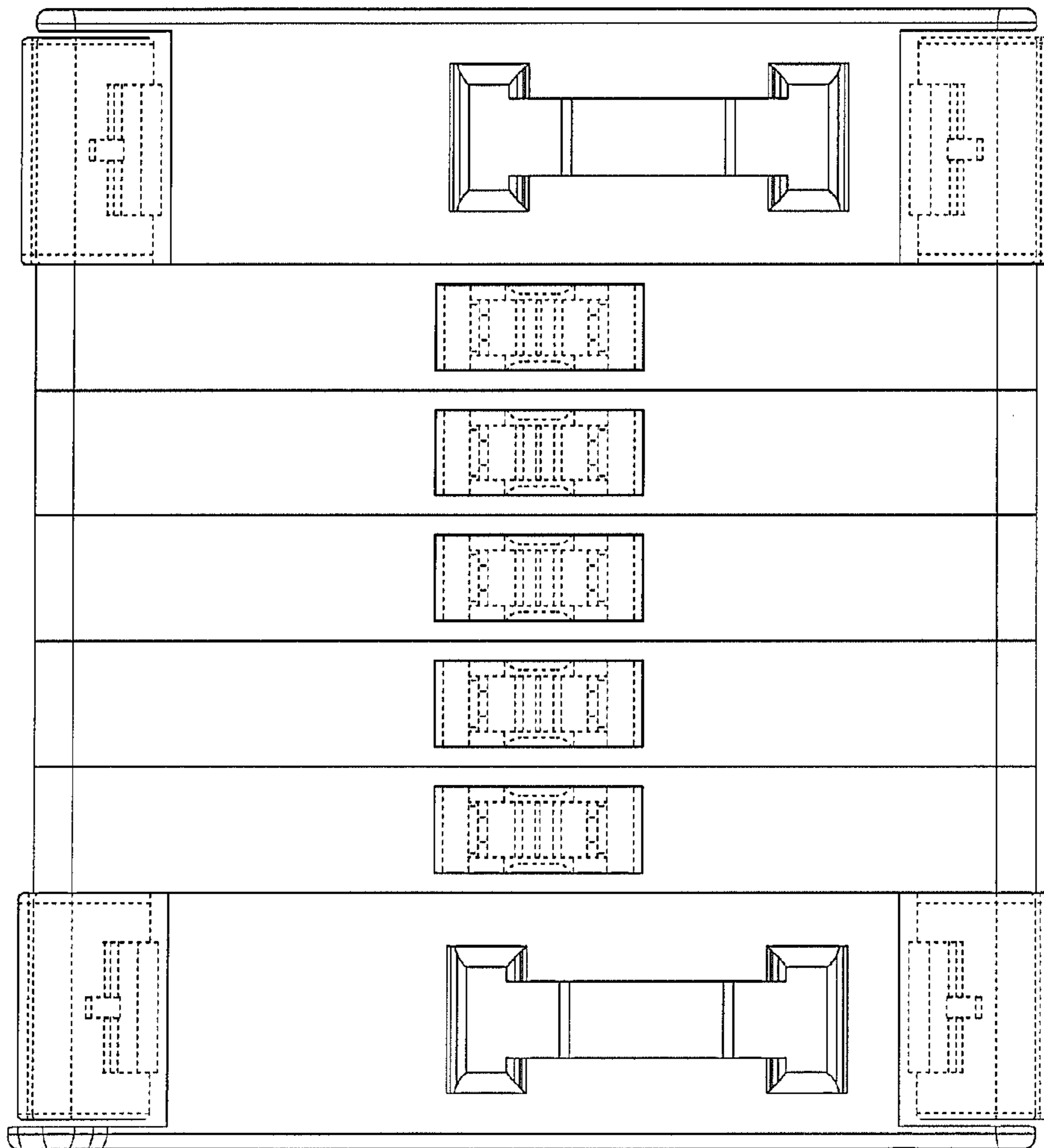

FIG. 3

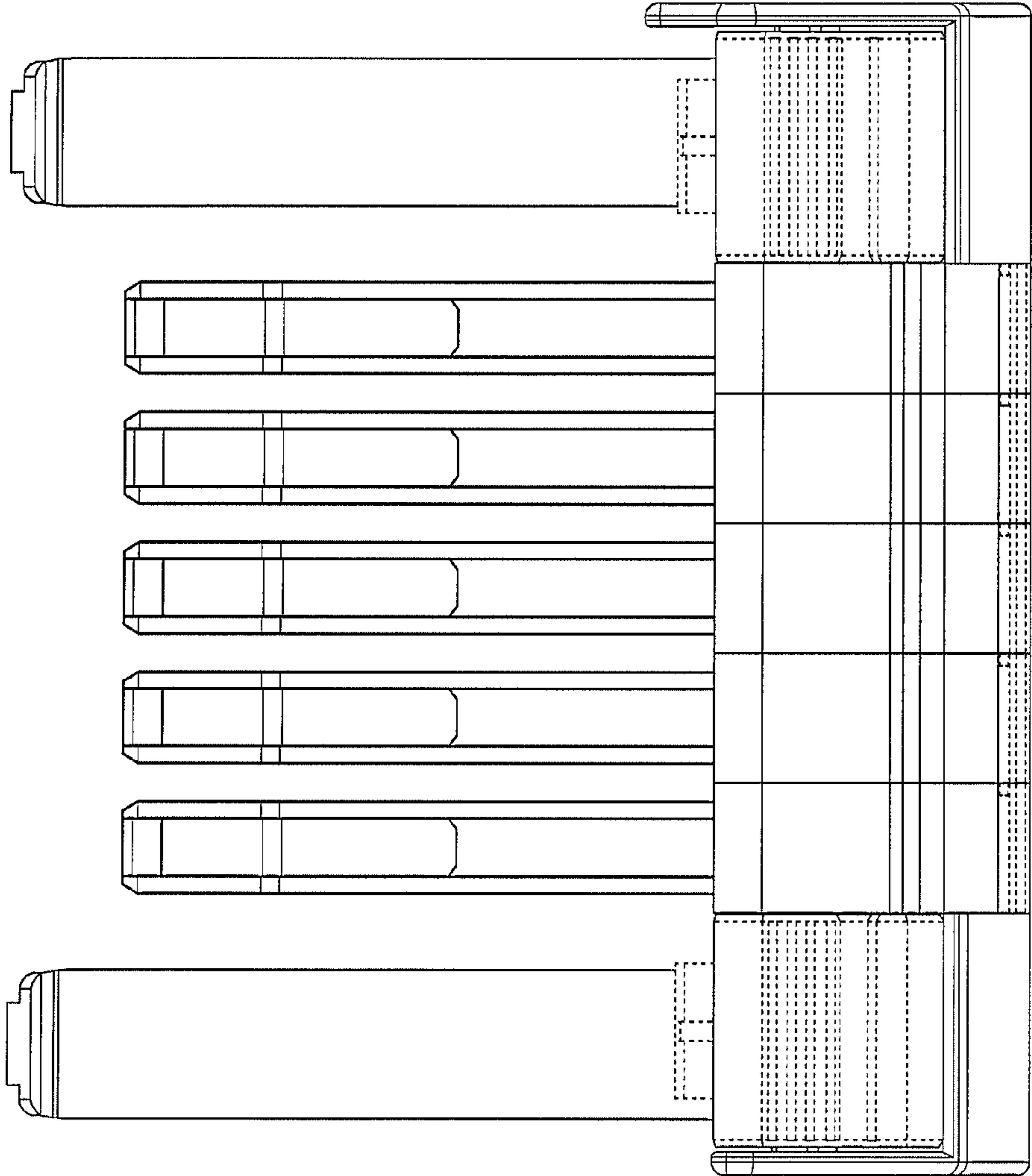

FIG. 4

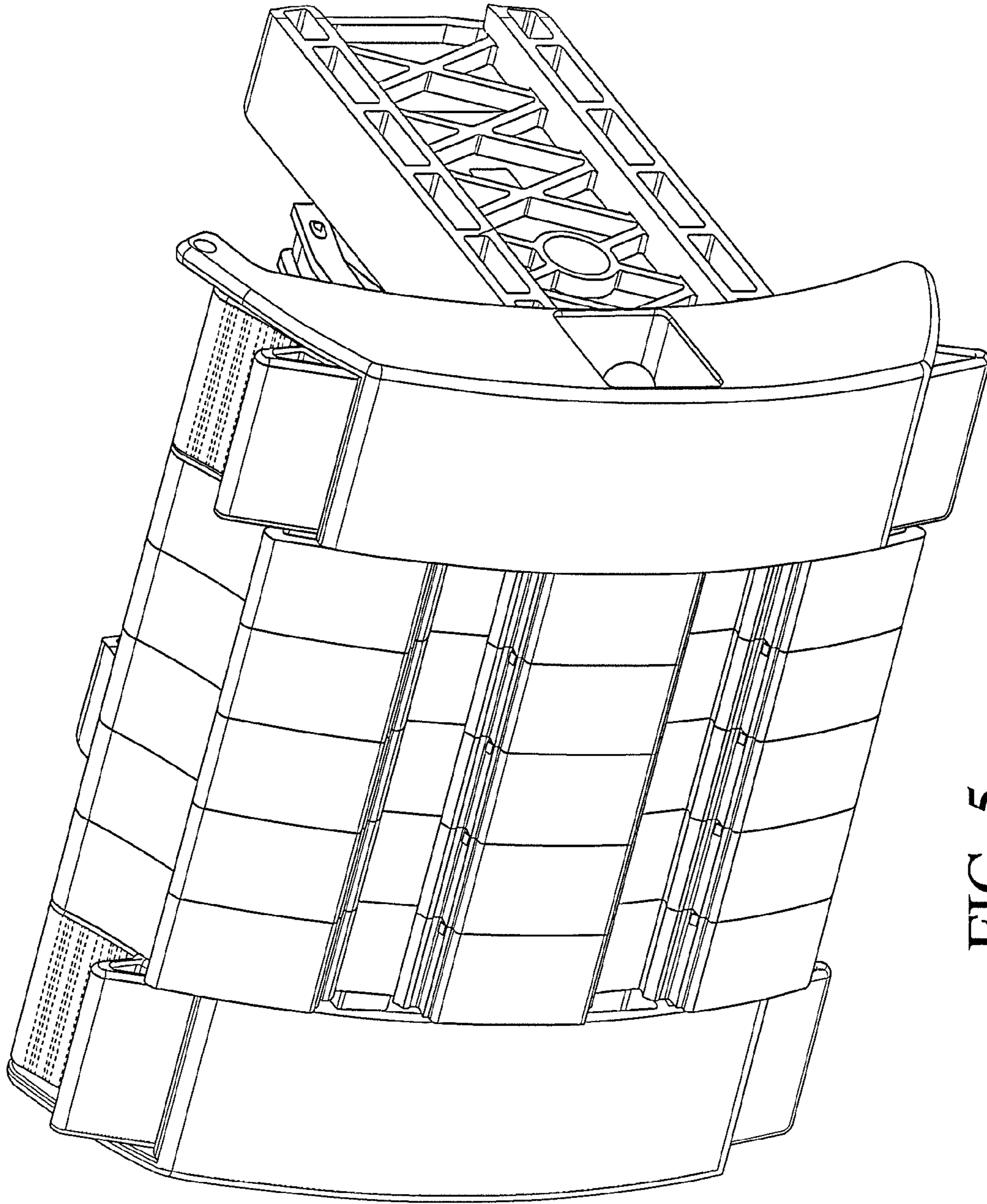

FIG. 5

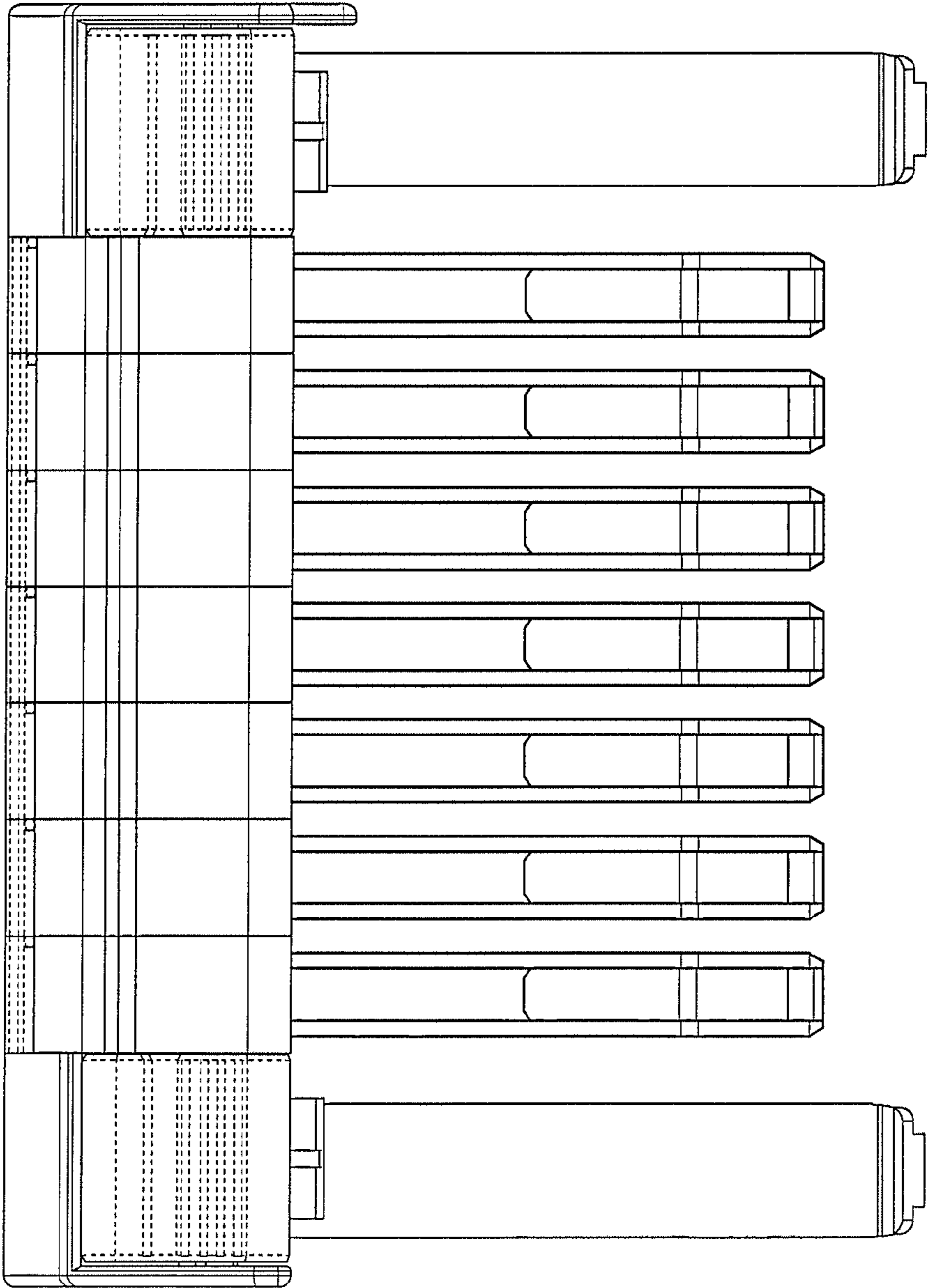

FIG. 6

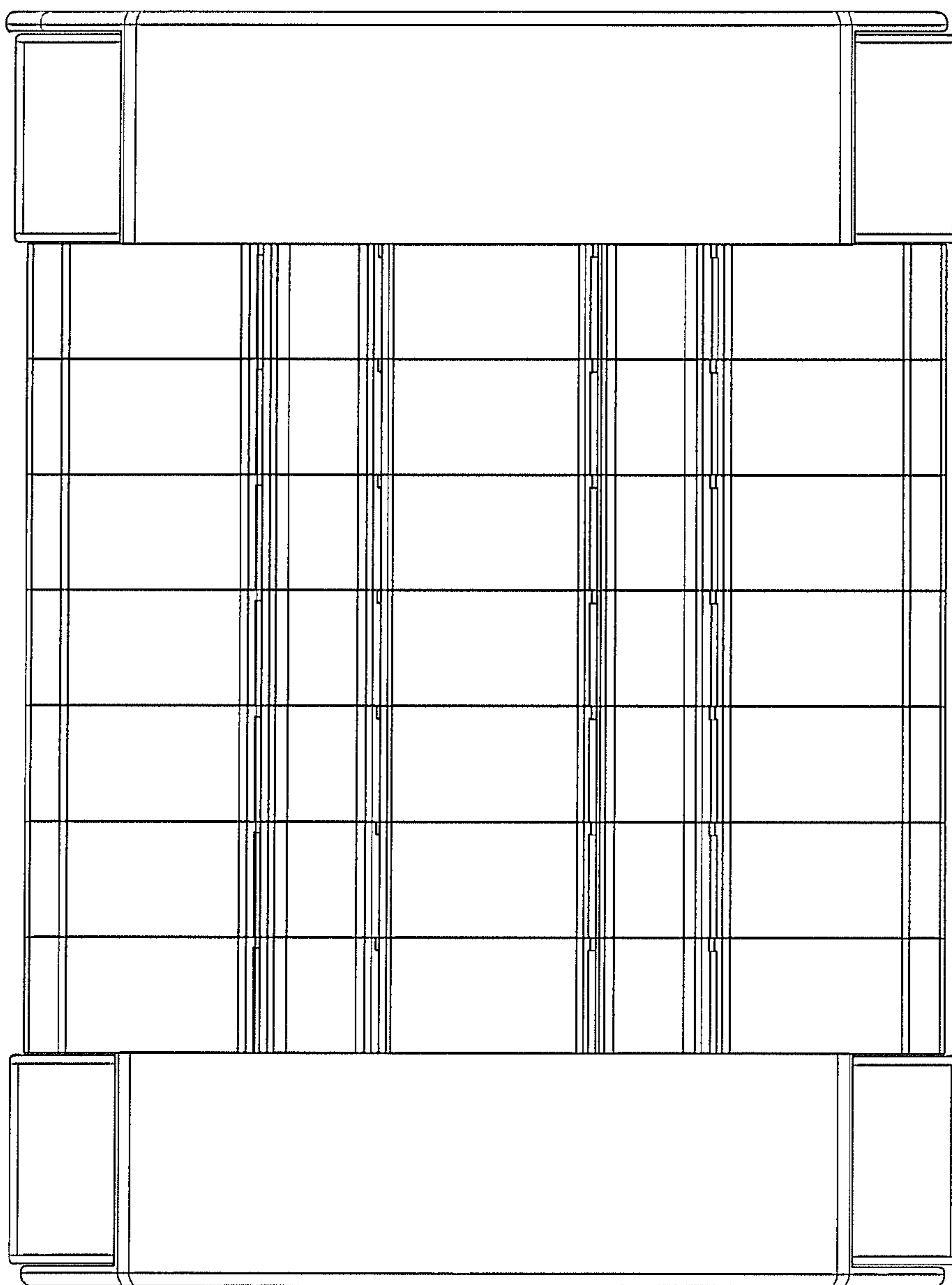

FIG. 7



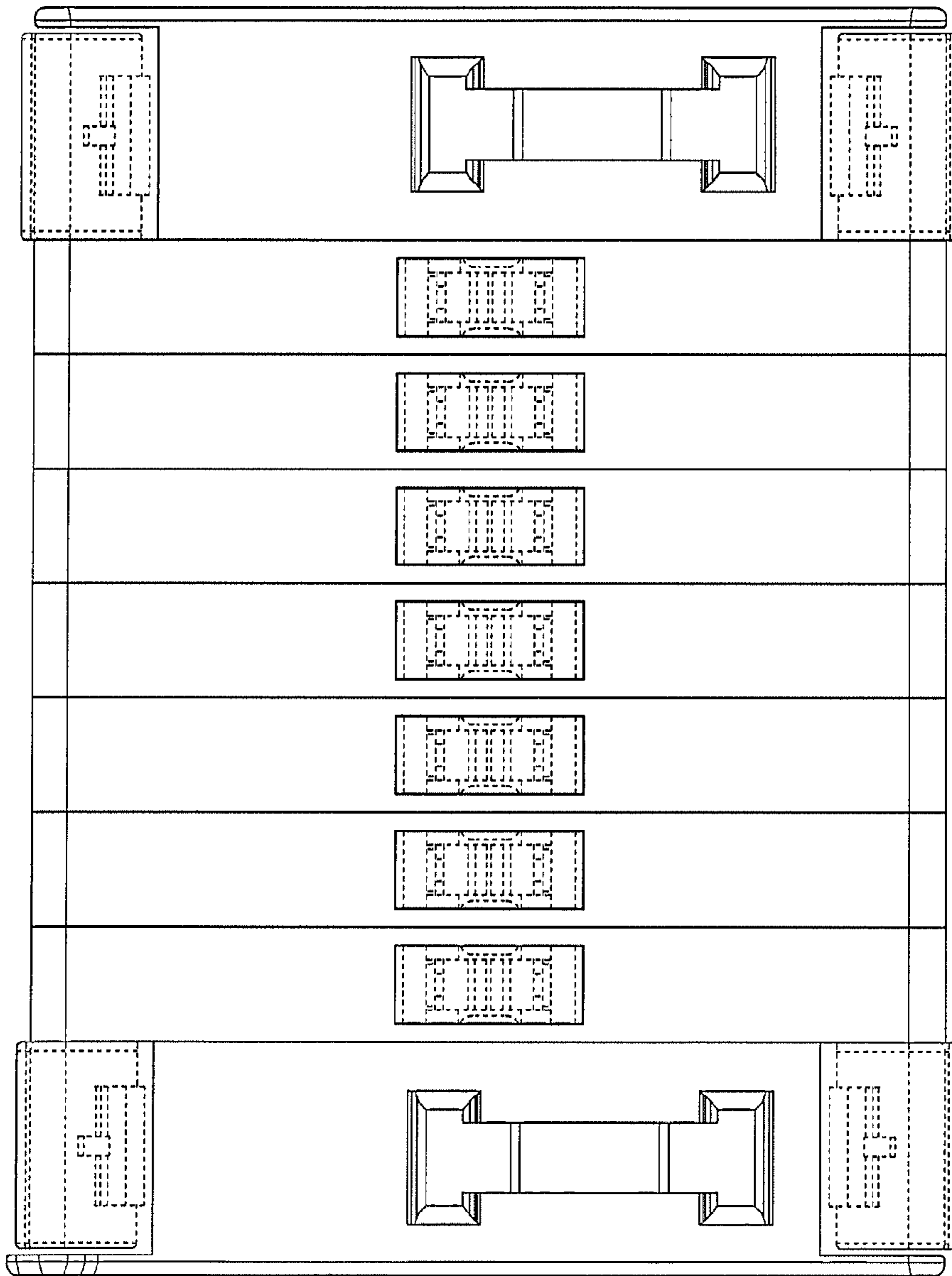

FIG. 8

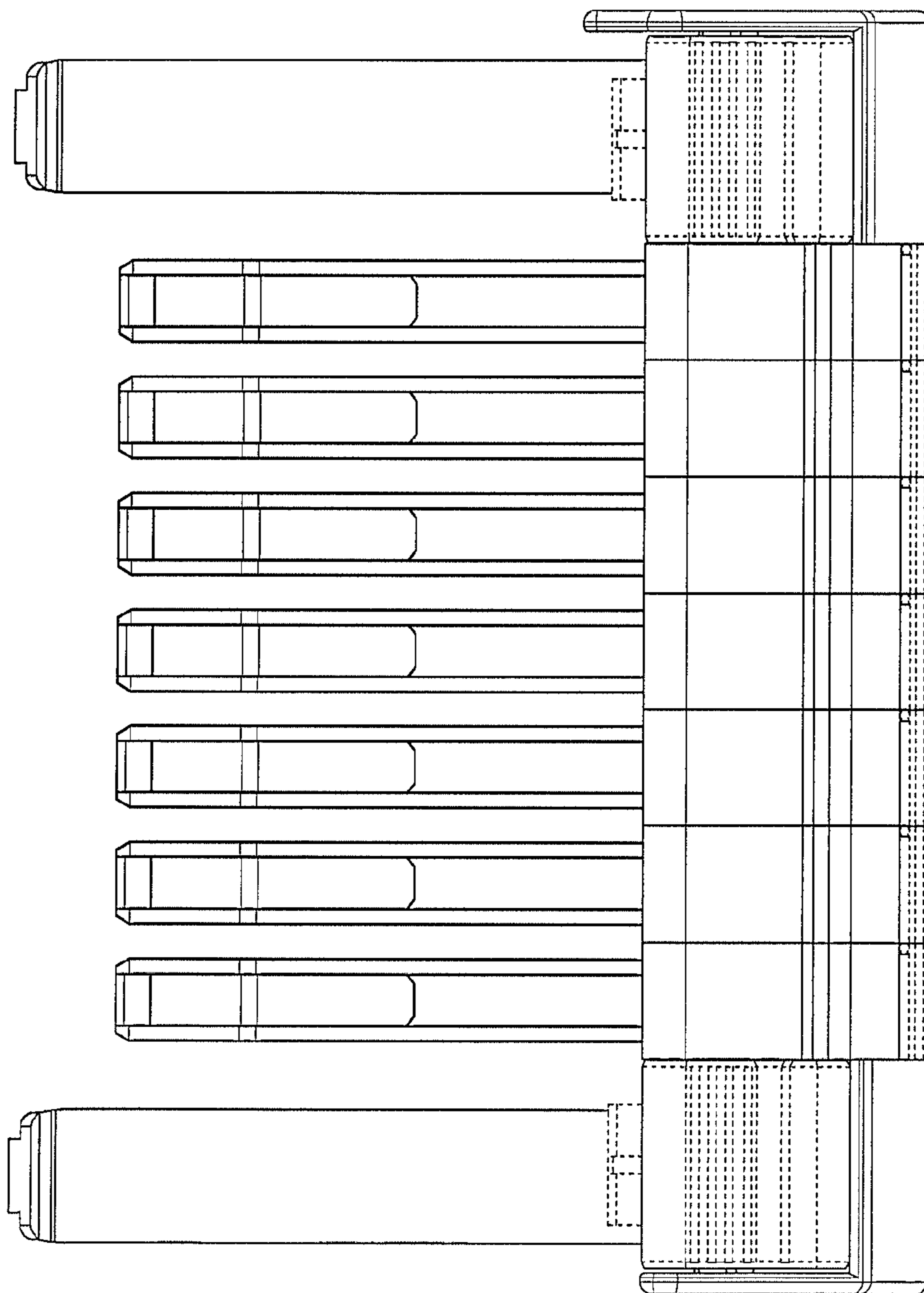

FIG. 9

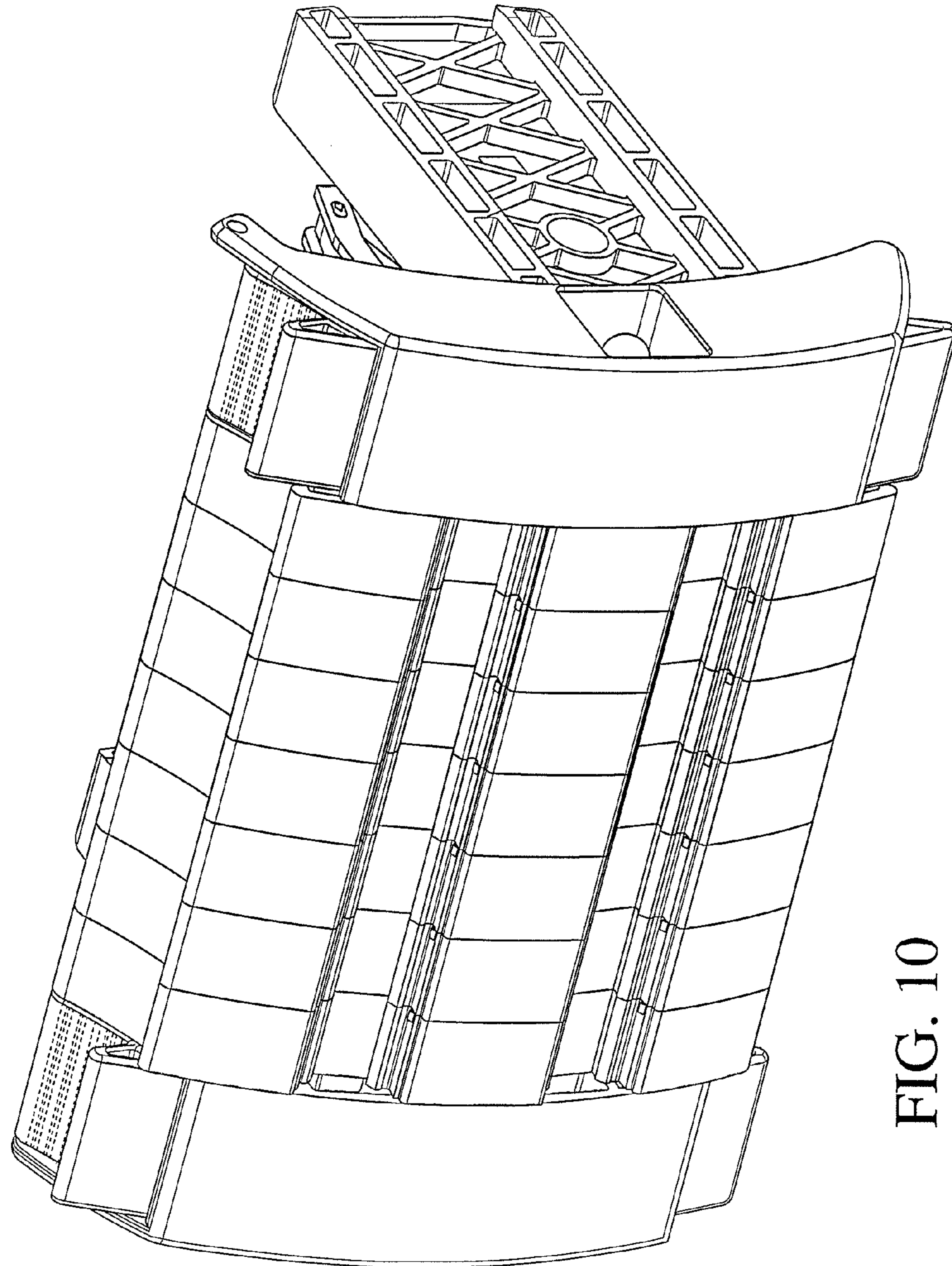

FIG. 10

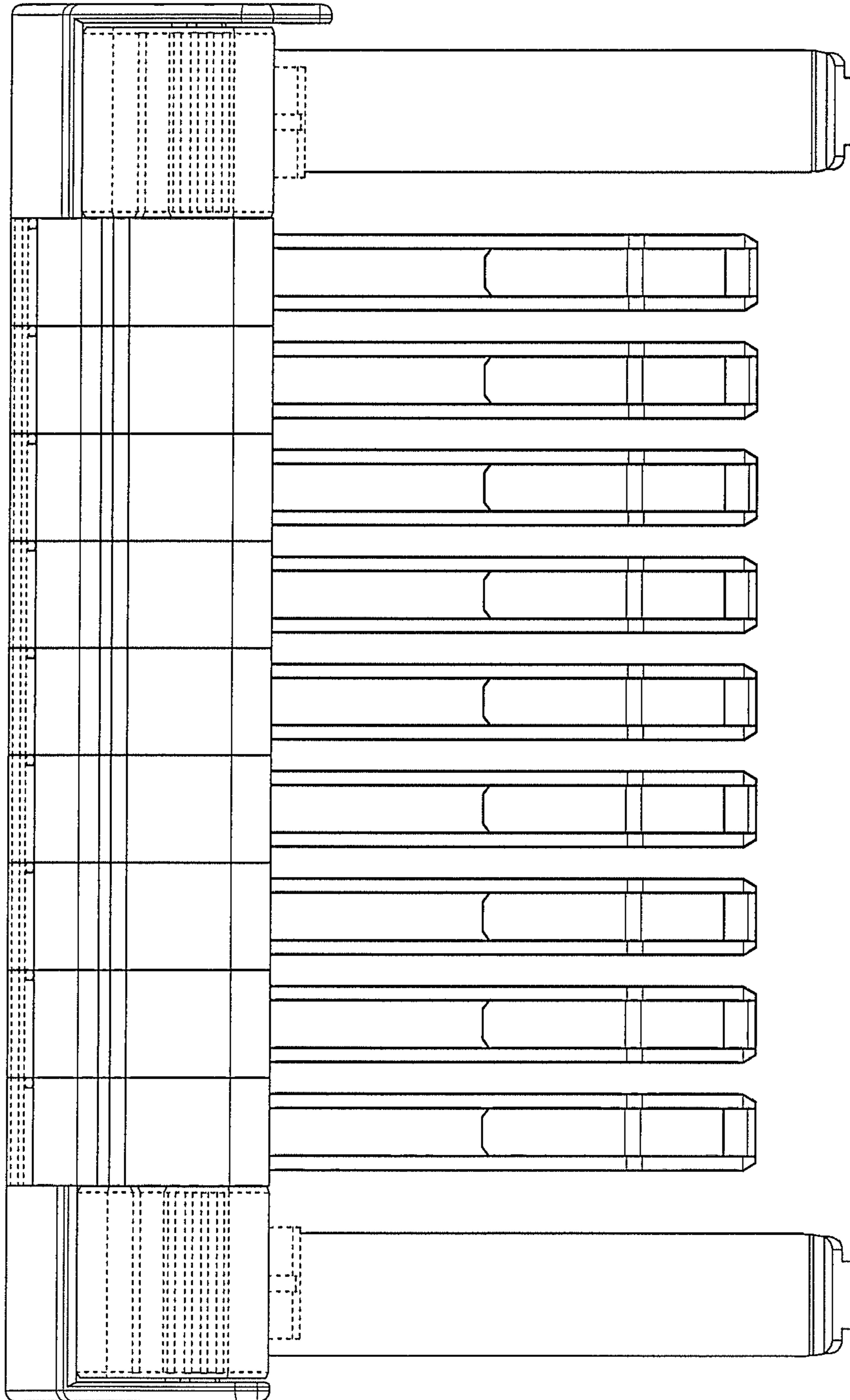

FIG. 11

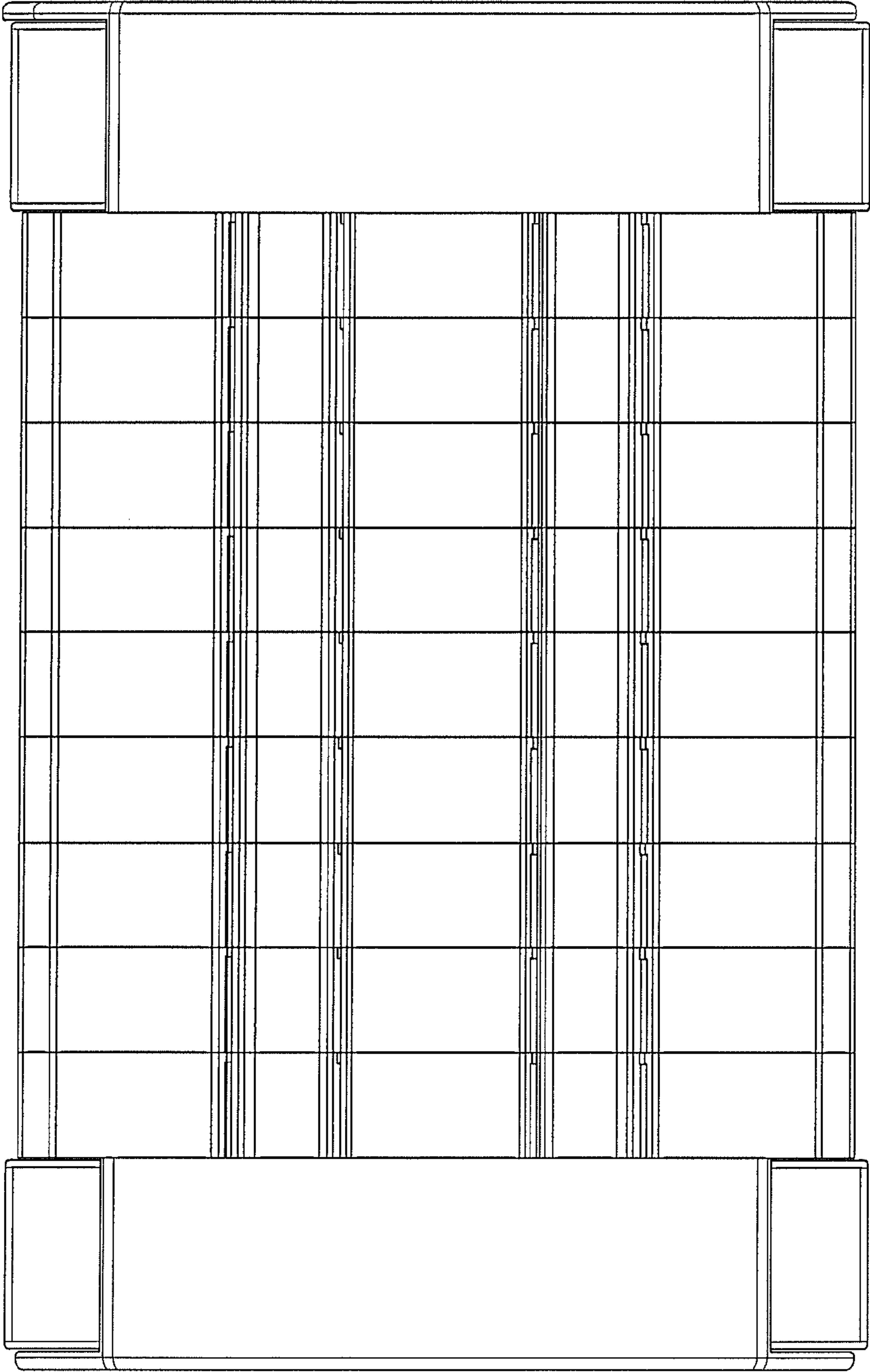

FIG. 12

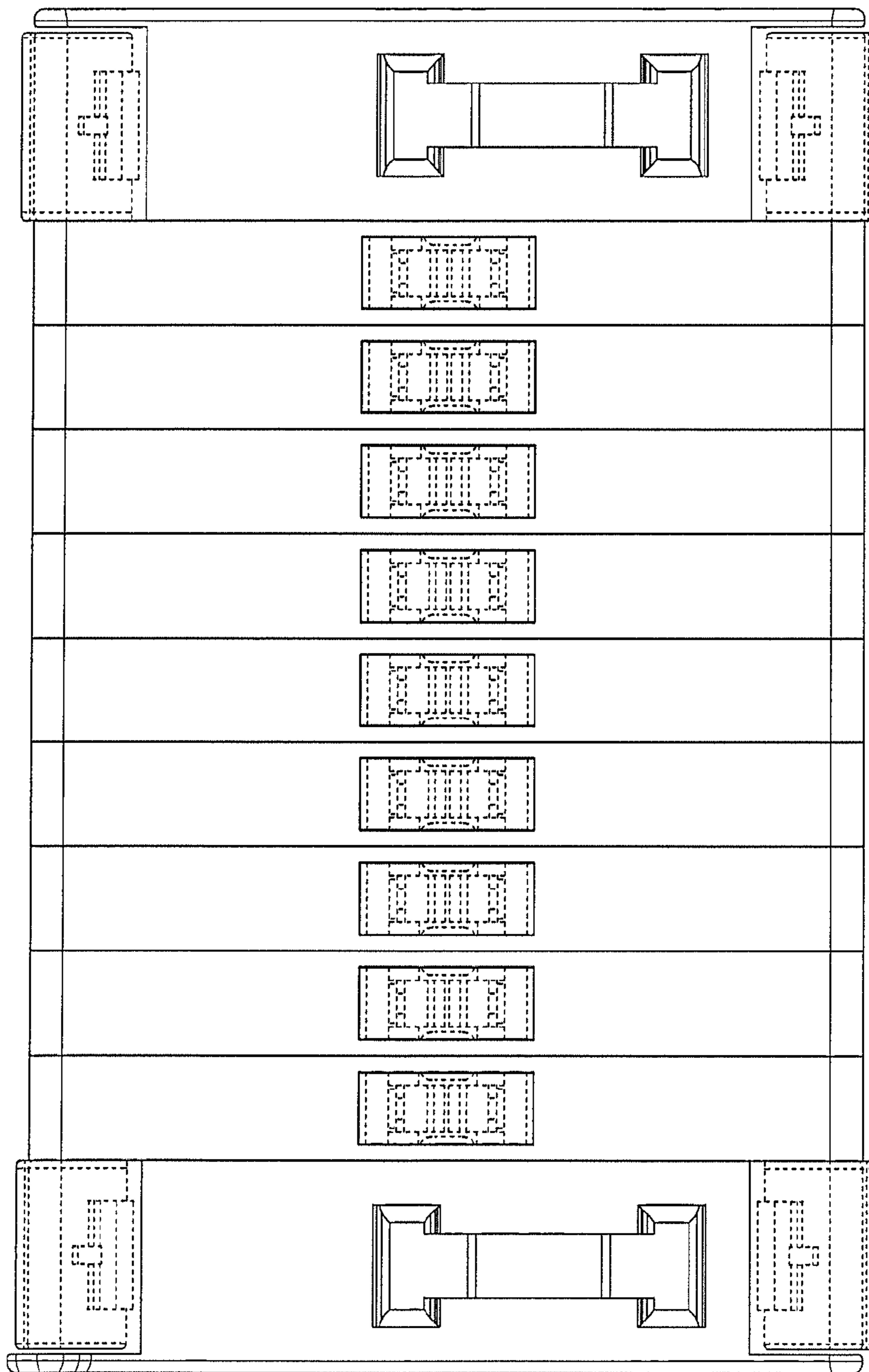

FIG. 13

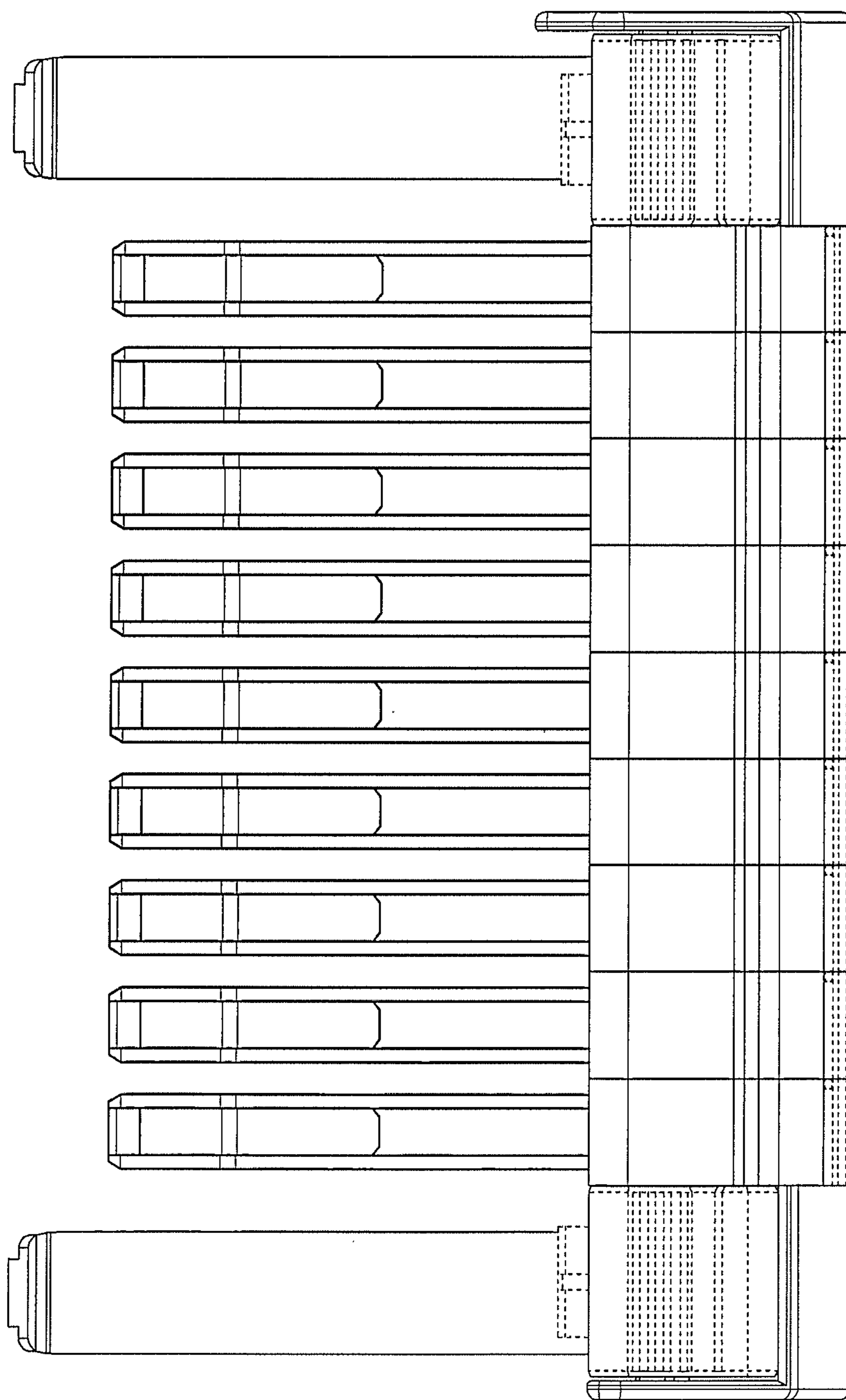

FIG. 14

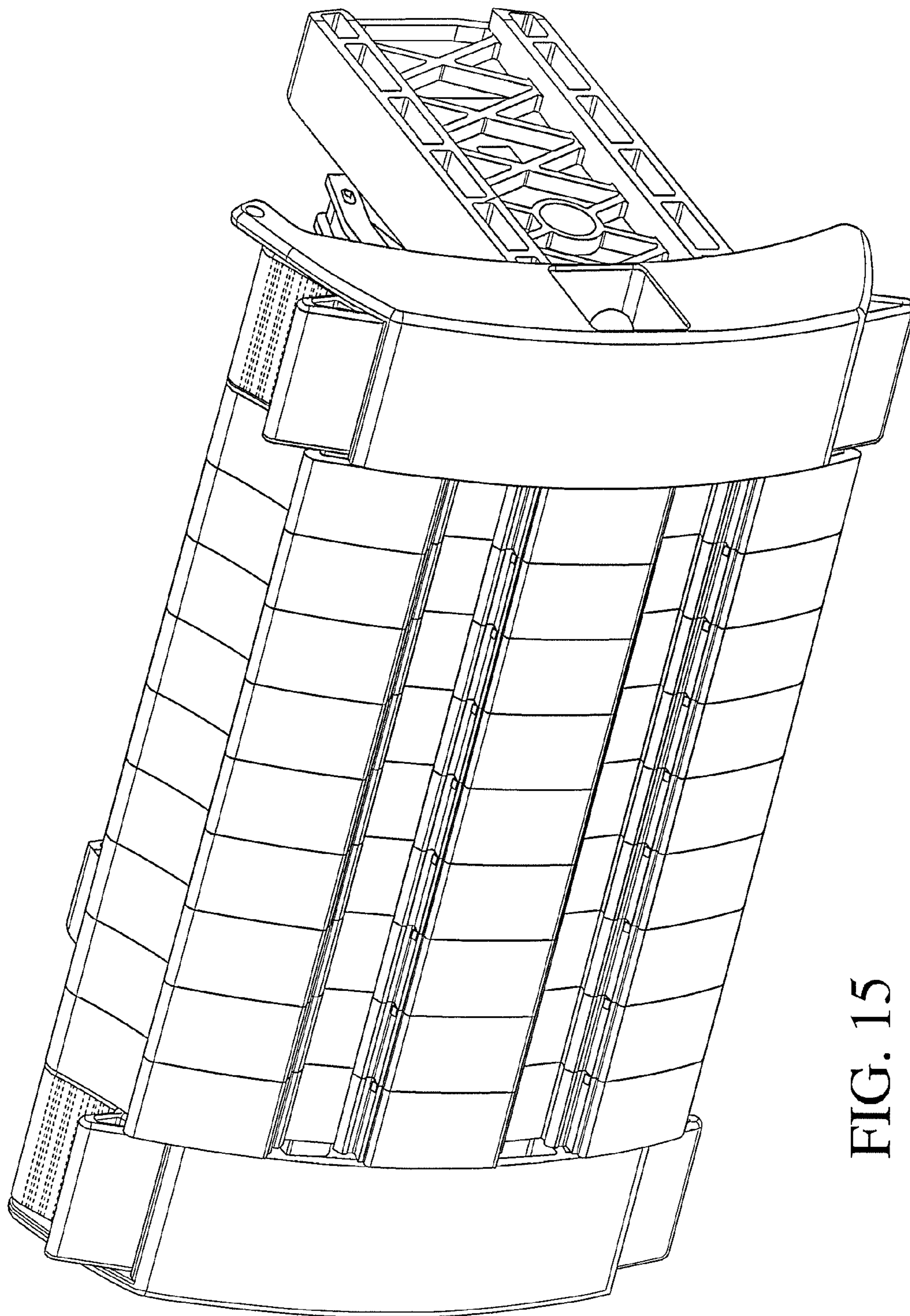

FIG. 15



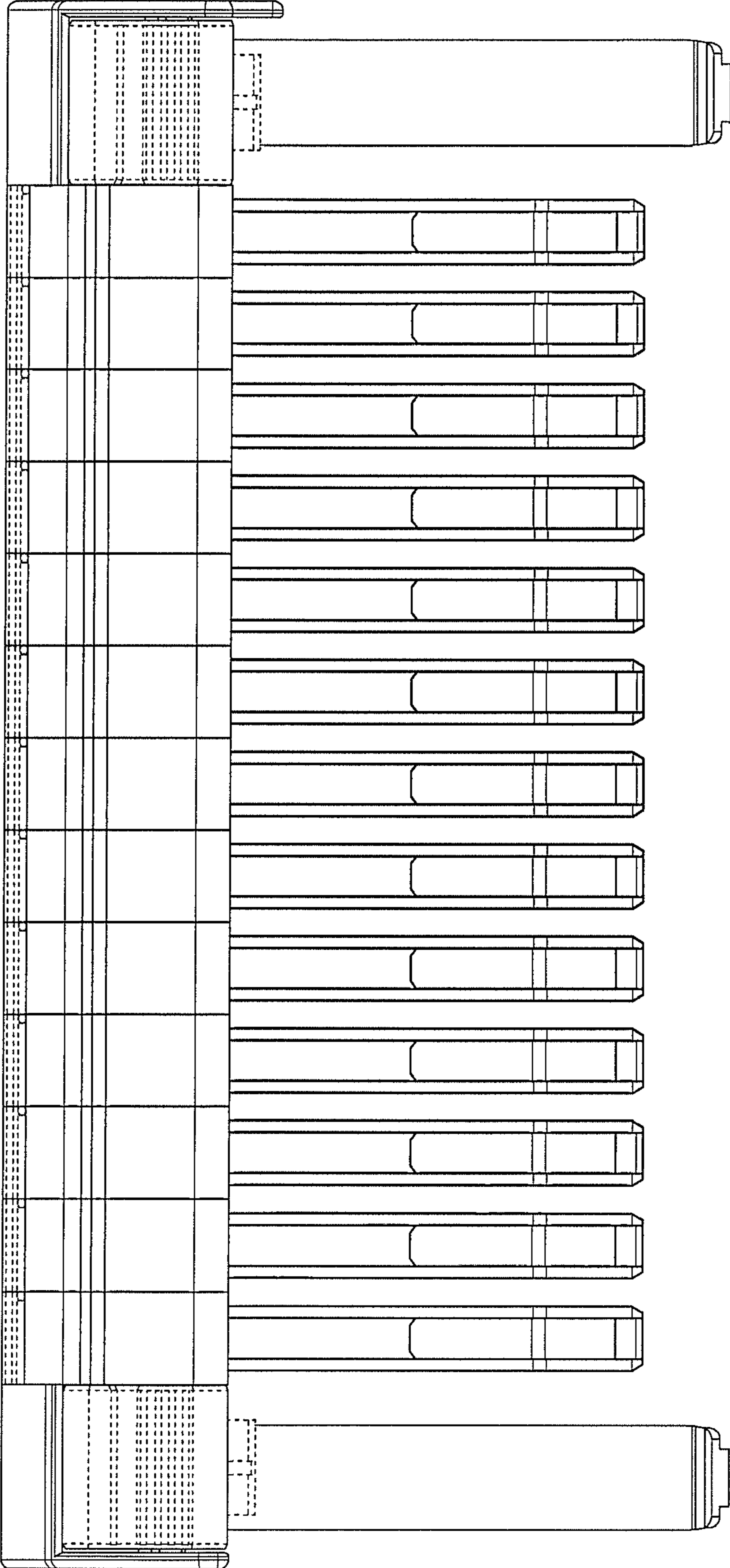

FIG. 16

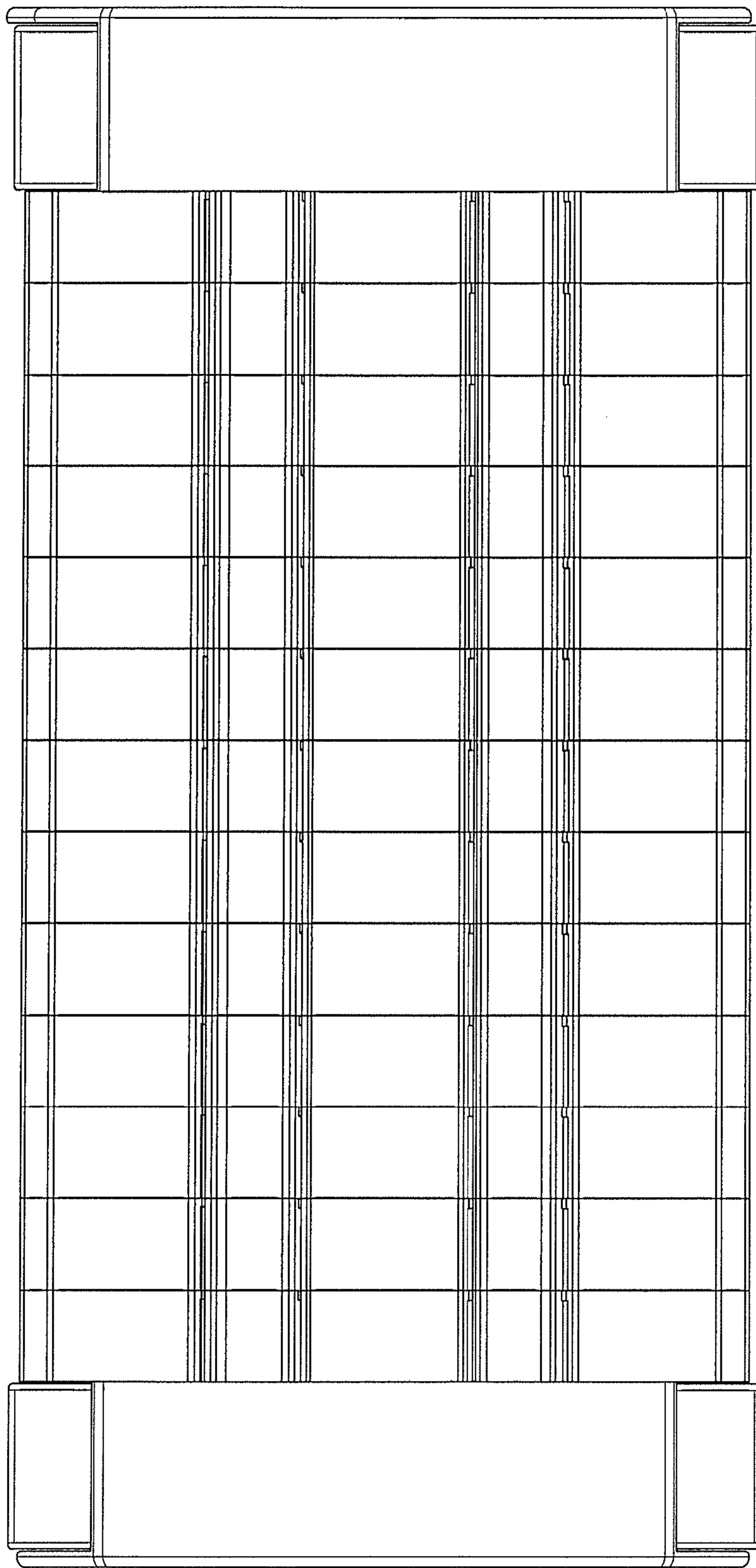

FIG. 17

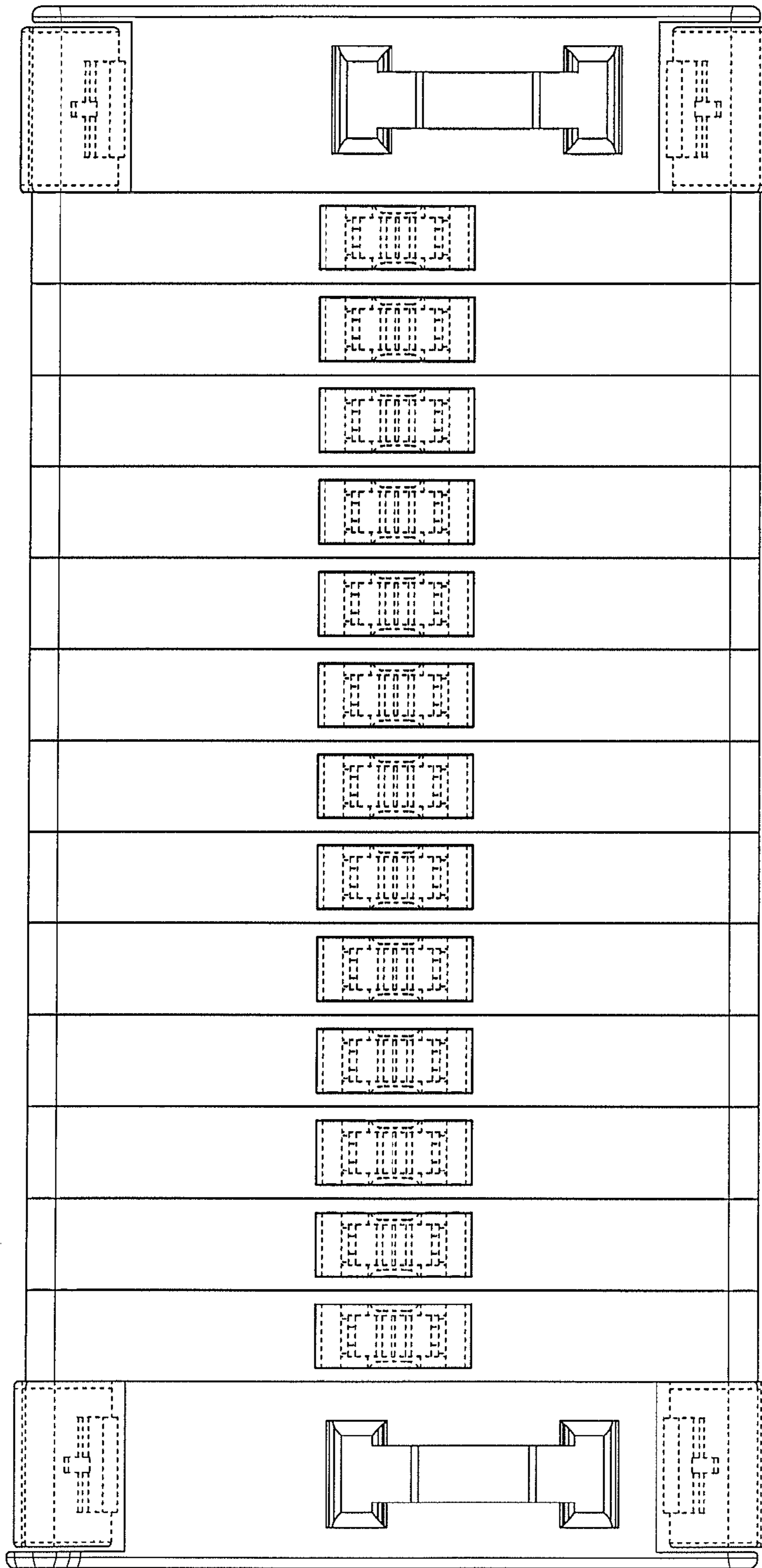

FIG. 18

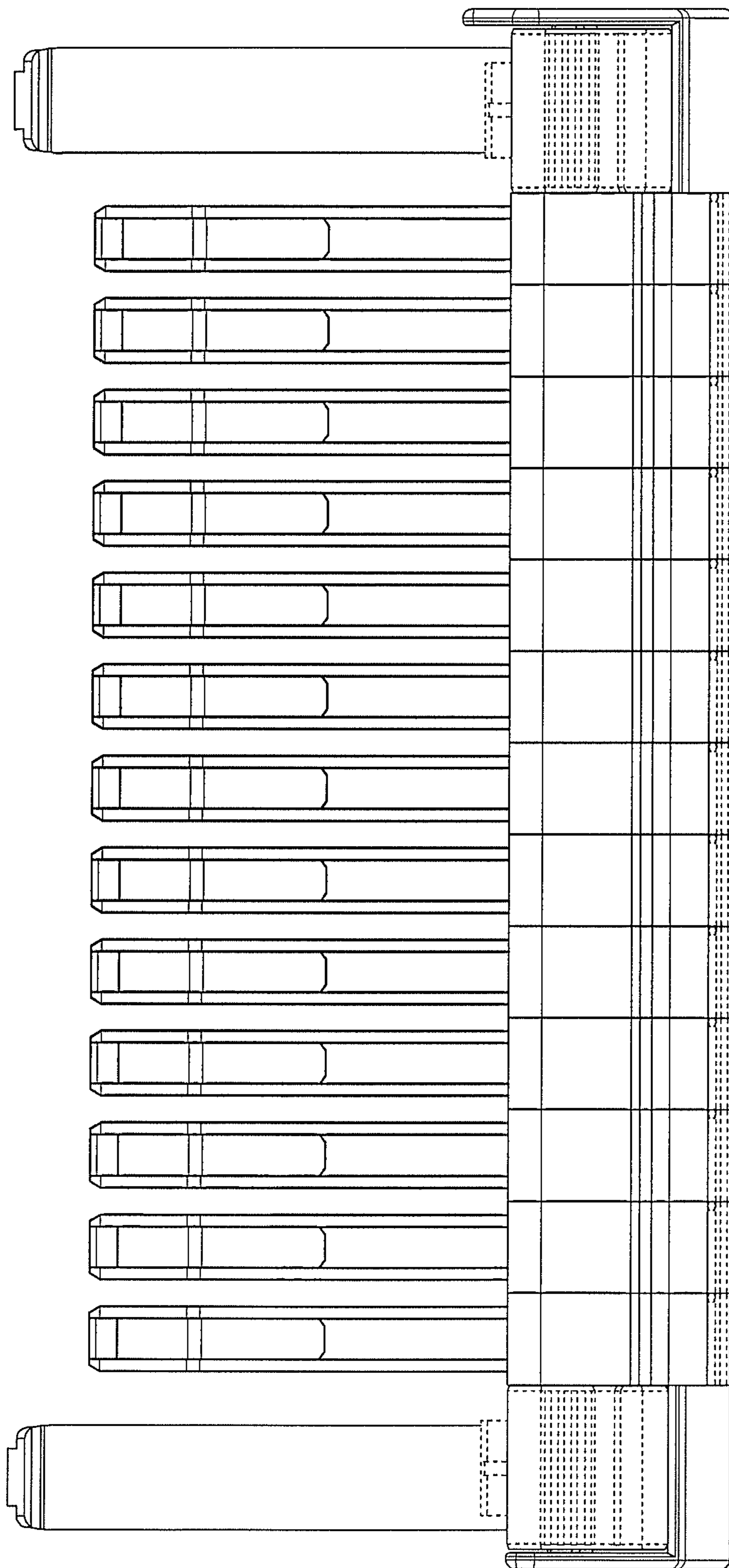

FIG. 19

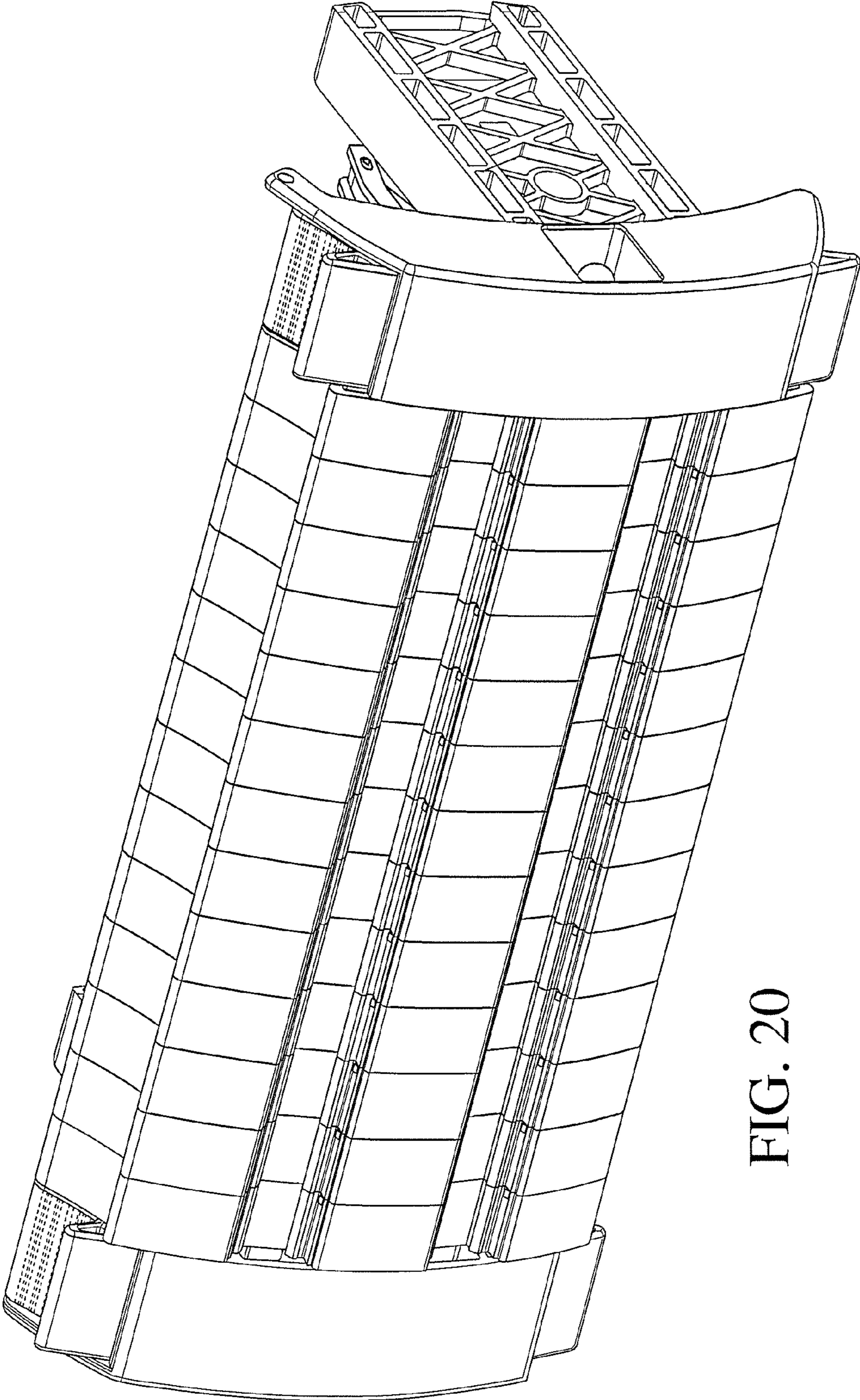

FIG. 20

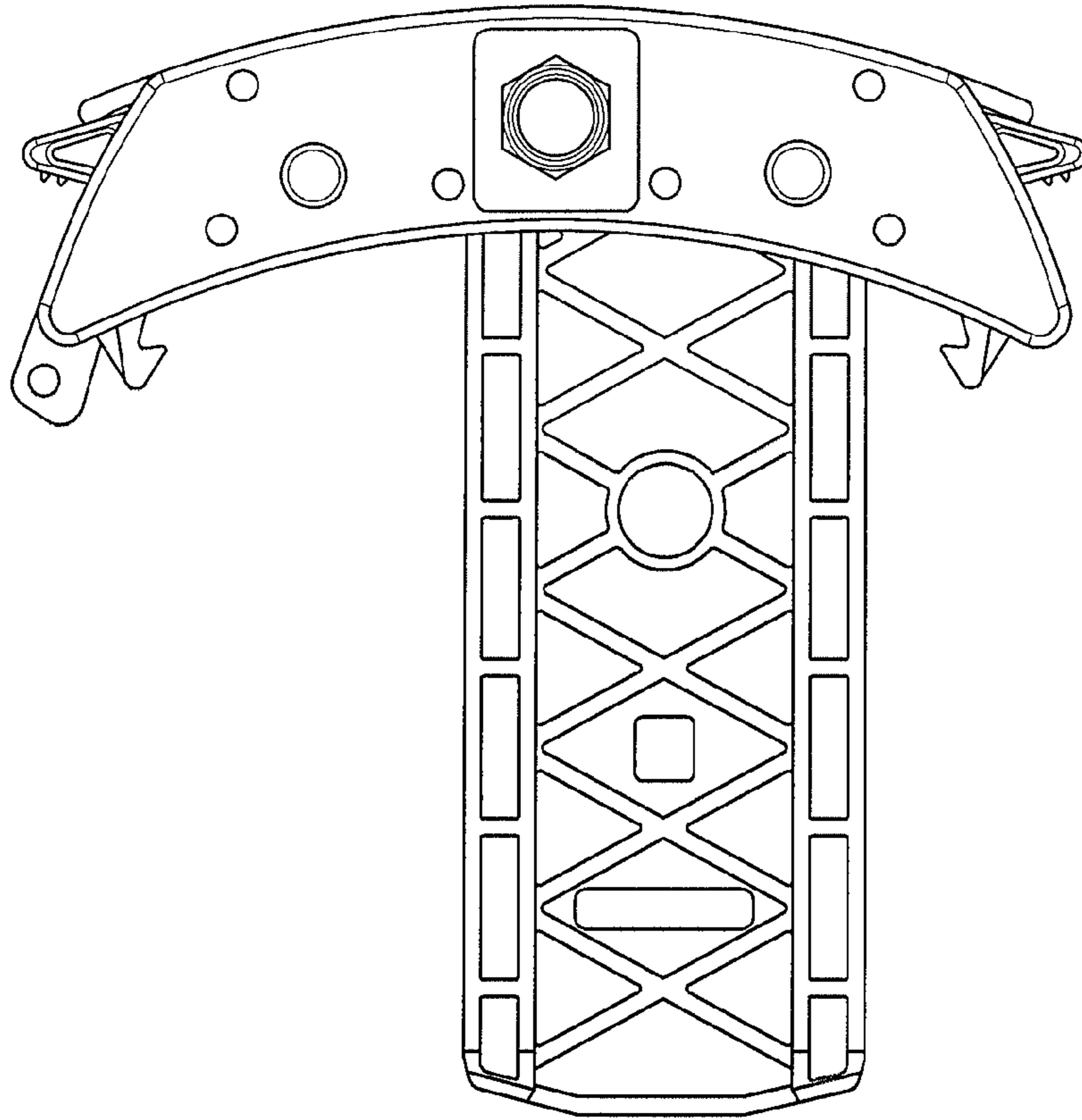

FIG. 22

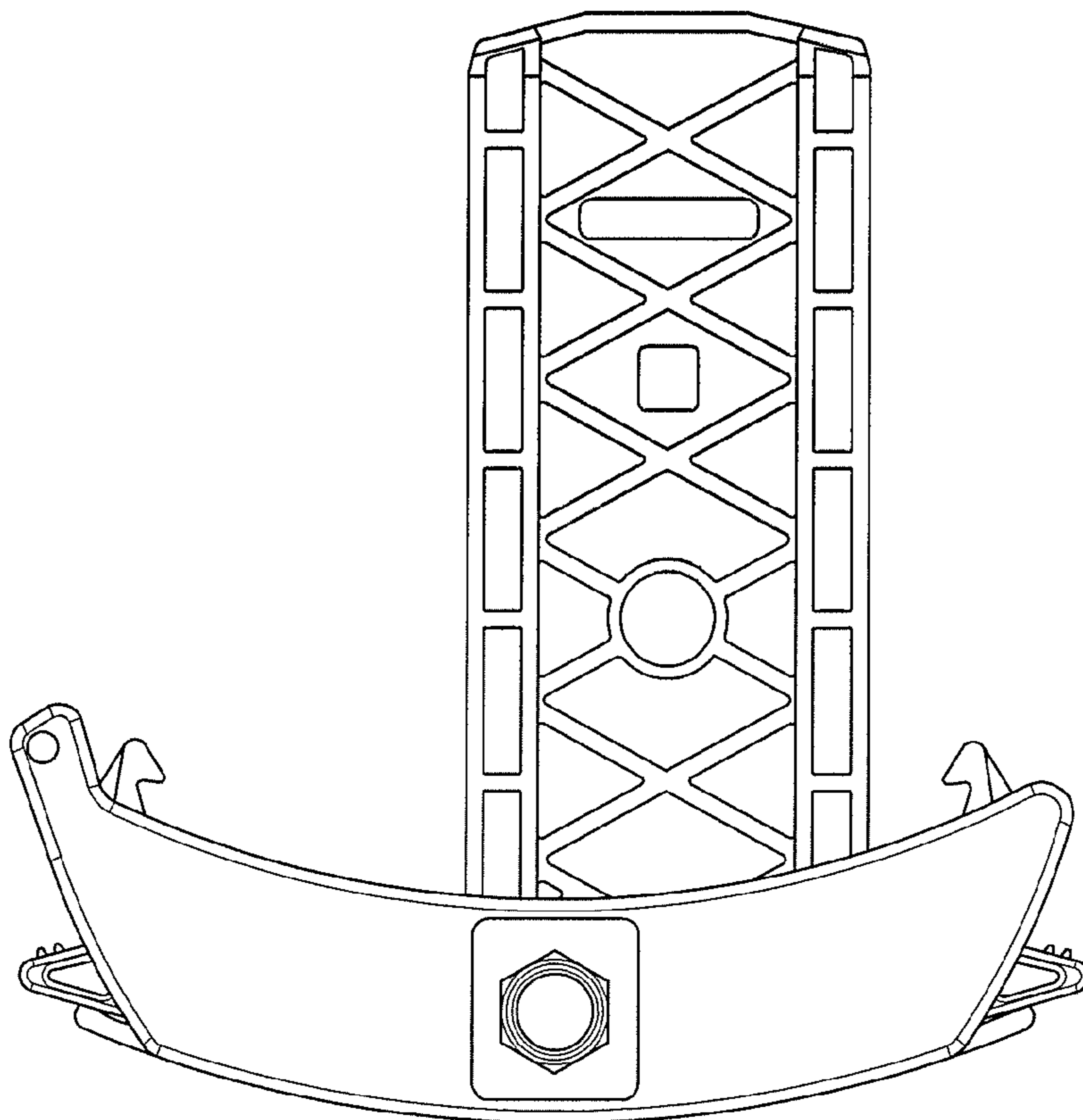

FIG. 21