

US00D732424S

(12) **United States Design Patent**
Ng

(10) **Patent No.:** **US D732,424 S**
(45) **Date of Patent:** **** Jun. 23, 2015**

(54) **SLIDE FASTENER**

(71) Applicant: **Wang Lap Ronny Ng**, New Territories
(HK)

(72) Inventor: **Wang Lap Ronny Ng**, New Territories
(HK)

(**) Term: **14 Years**

(21) Appl. No.: **29/490,240**

(22) Filed: **May 8, 2014**

(30) **Foreign Application Priority Data**

Nov. 8, 2013 (HK) 1301979

(51) **LOC (10) Cl.** **02-07**

(52) **U.S. Cl.**
USPC **D11/221**

(58) **Field of Classification Search**
USPC D11/200, 201, 221, 86, 87;
24/381-383, 385-387, 414-417,
24/421-422, 427-431, 433, 424; 2/265;
D2/641, 642; 294/3.6; 223/118
CPC A44B 19/00; A44B 19/02; A44B 19/04;
A44B 19/10; A44B 19/24; A44B 19/26;
A44B 19/30

See application file for complete search history.

(56) **References Cited**

U.S. PATENT DOCUMENTS

2,047,925 A * 7/1936 Corner 24/414
2,268,571 A * 1/1942 Corner 264/342 R
2,335,668 A * 11/1943 Hamm 24/405
2,628,400 A * 2/1953 Osborne 24/411
4,004,327 A * 1/1977 Fukuroi et al. 24/411
4,651,388 A * 3/1987 Horikawa et al. 24/409
5,394,593 A * 3/1995 Aoki 24/411
7,665,193 B2 * 2/2010 Hasegawa et al. 24/410
D628,123 S * 11/2010 Kojima et al. D11/221
D631,789 S * 2/2011 Takani D11/221
D632,218 S * 2/2011 Yamamoto et al. D11/221
D644,564 S * 9/2011 Kojima et al. D11/221

D657,287 S * 4/2012 Cheng D11/221
D672,686 S * 12/2012 Masani et al. D11/221
D672,687 S * 12/2012 Himi D11/221
D673,077 S * 12/2012 Fujita D11/221
D712,785 S * 9/2014 Ng D11/221

* cited by examiner

Primary Examiner — Ralf Seifert

(74) *Attorney, Agent, or Firm* — Gloria Tsui-Yip, Esq.;
Miskin & Tsui-Yip LLP

(57) **CLAIM**

The ornamental design for a slide fastener, as shown and described.

DESCRIPTION

FIG. 1 is a left side view of a first element of my new design; FIG. 2 is a front elevational view thereof; FIG. 3 is a right side view thereof; FIG. 4 is a top plan view thereof; FIG. 5 is a bottom plan view thereof; FIG. 6 is a rear elevational view thereof; FIG. 7 is a perspective view thereof; FIG. 8 is another perspective view thereof; FIG. 9 is a left side view of a second element of my new design; FIG. 10 is a front elevation view thereof; FIG. 11 is a right side view thereof; FIG. 12 is top plan view thereof; FIG. 13 is a bottom plan view thereof; FIG. 14 is a rear elevational view thereof; FIG. 15 is a perspective view thereof; FIG. 16 is another perspective view thereof; FIG. 17 is a front elevation view of a plurality of first and second elements of my new design interlocking with each other in a closed position; and, FIG. 18 is a perspective view of a plurality of first and second elements of my new design interlocking with each other in a partially open position. The broken line showing of the planar surfaces where the elements are attached in FIG. 18 illustrate environmental matter which form no part of the claimed design.

1 Claim, 7 Drawing Sheets

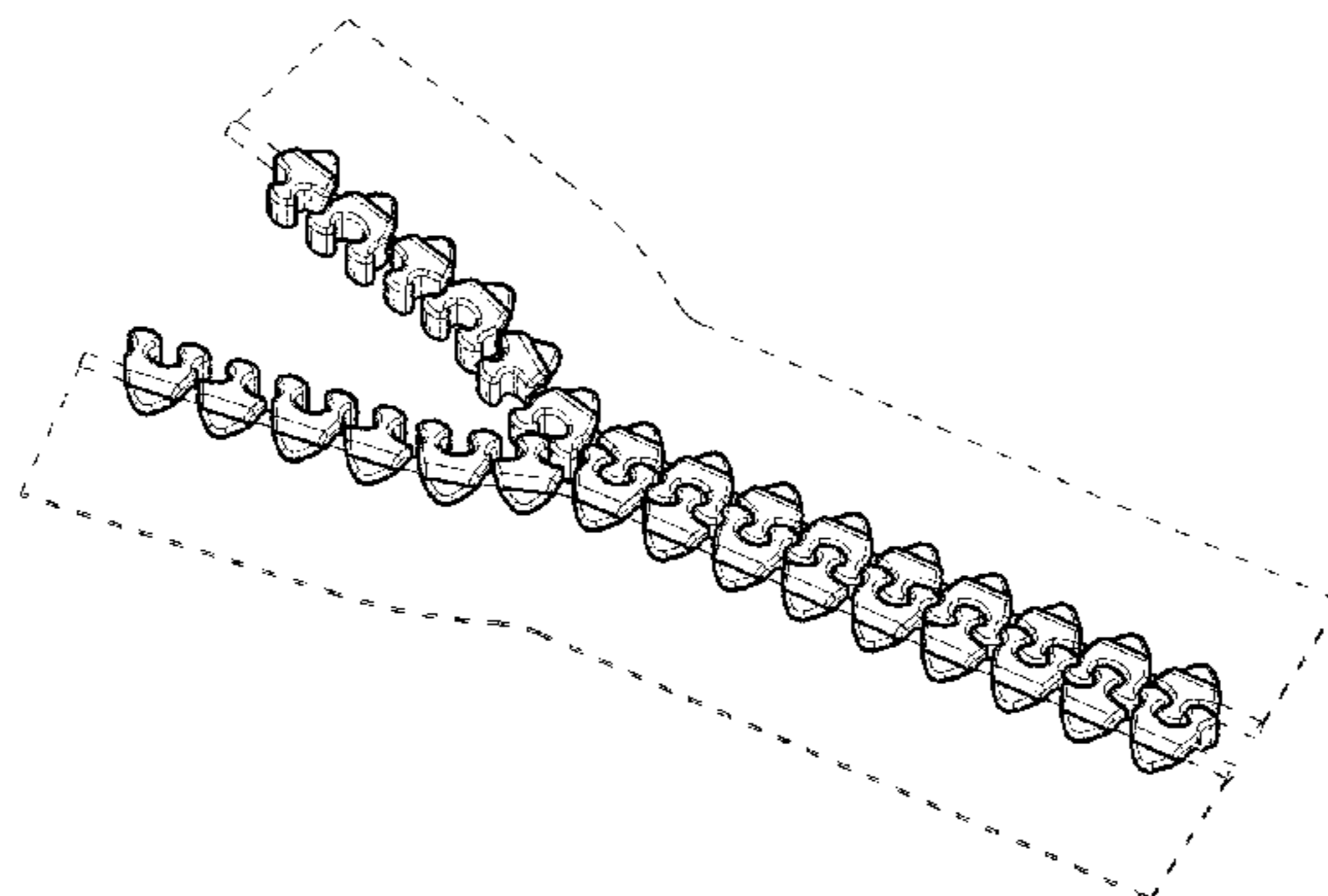

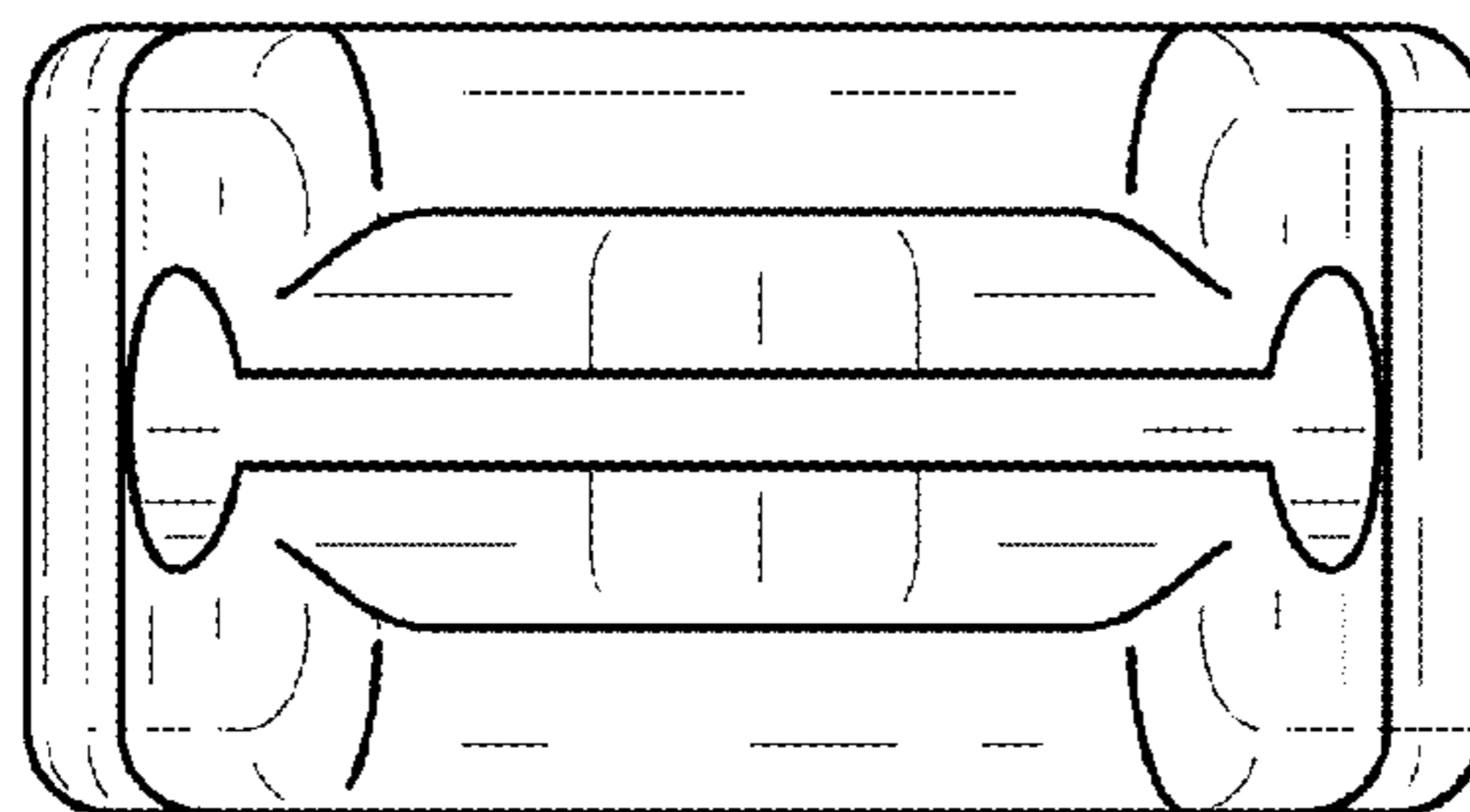

Fig.1

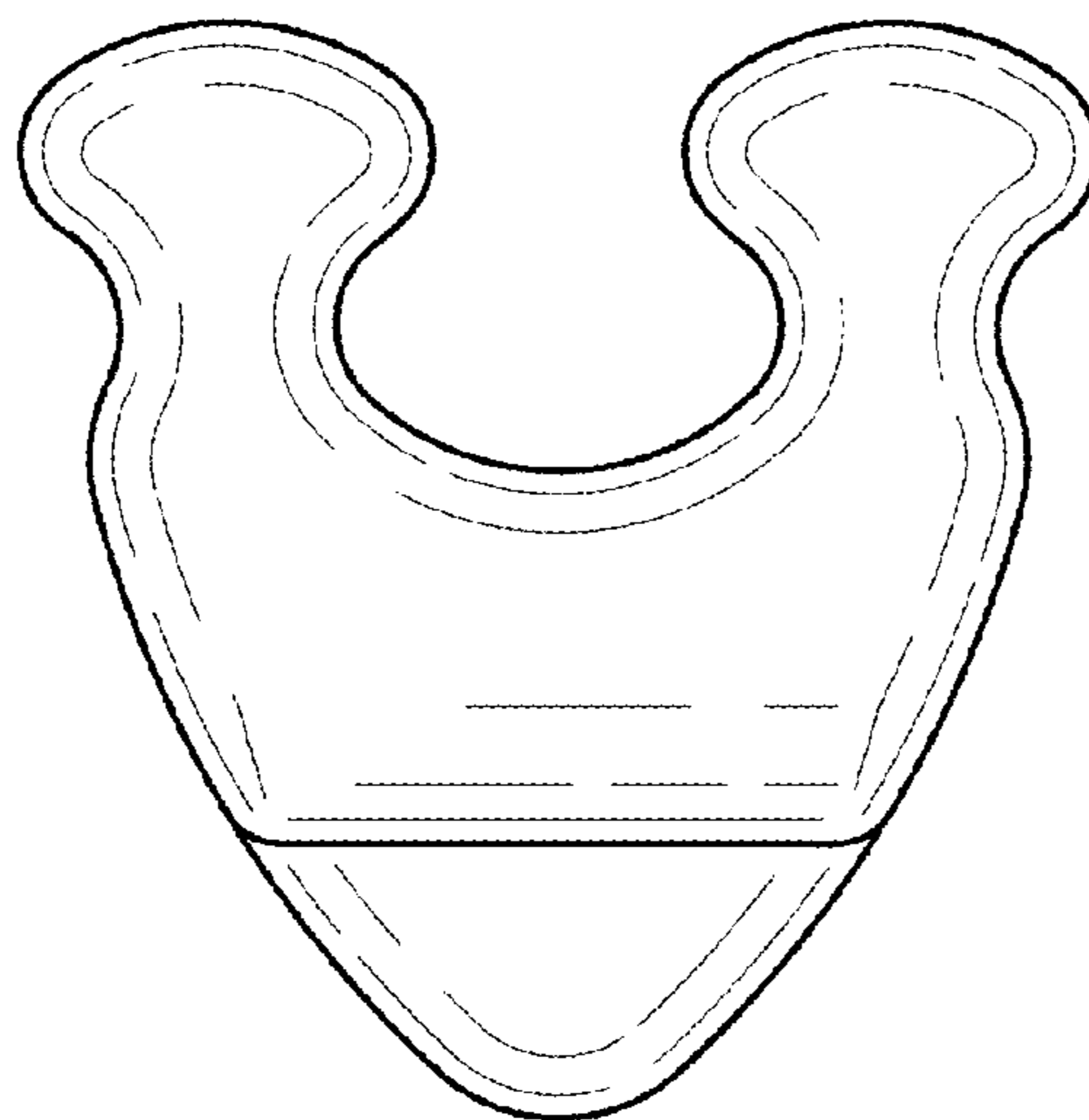

Fig.2

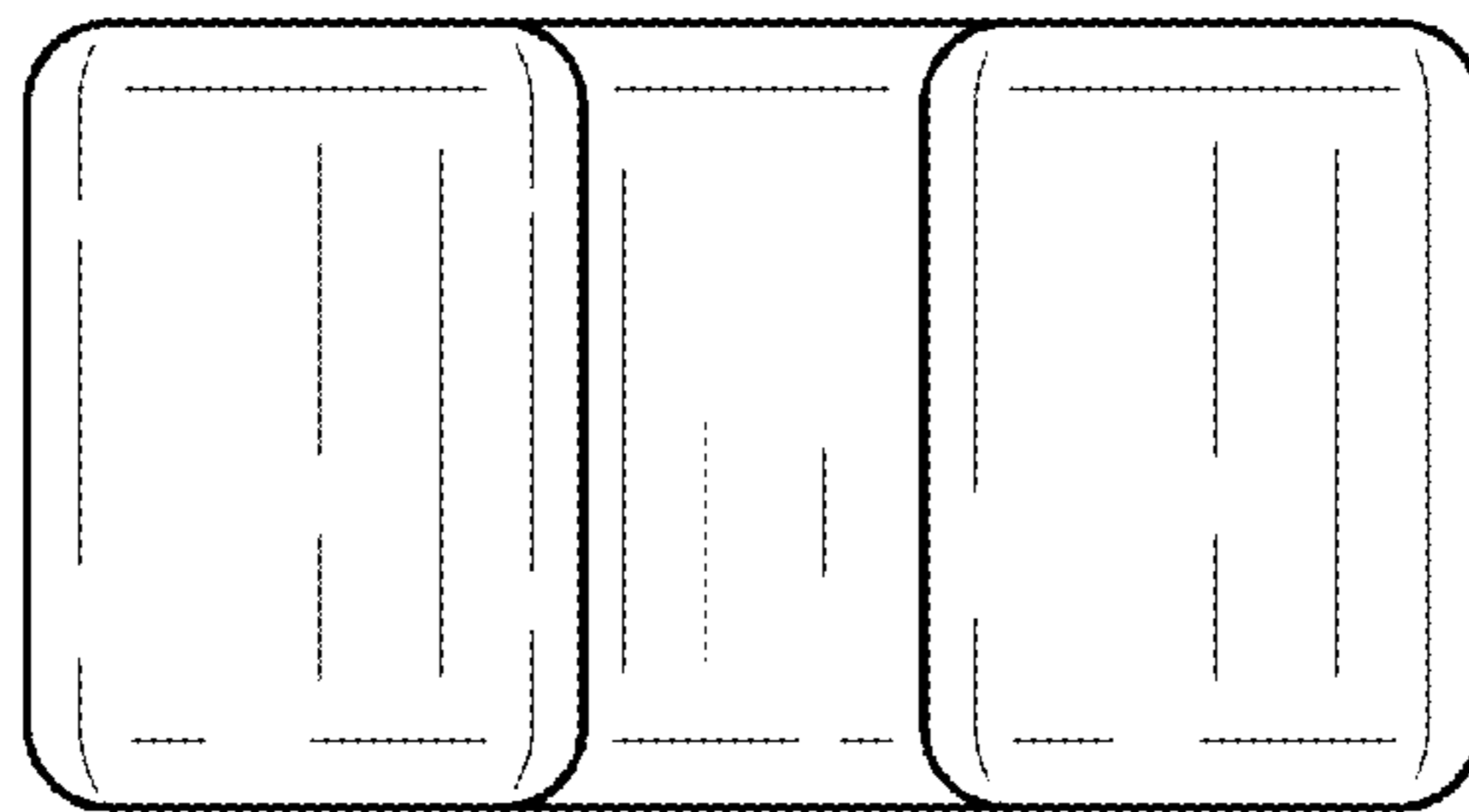

Fig.3

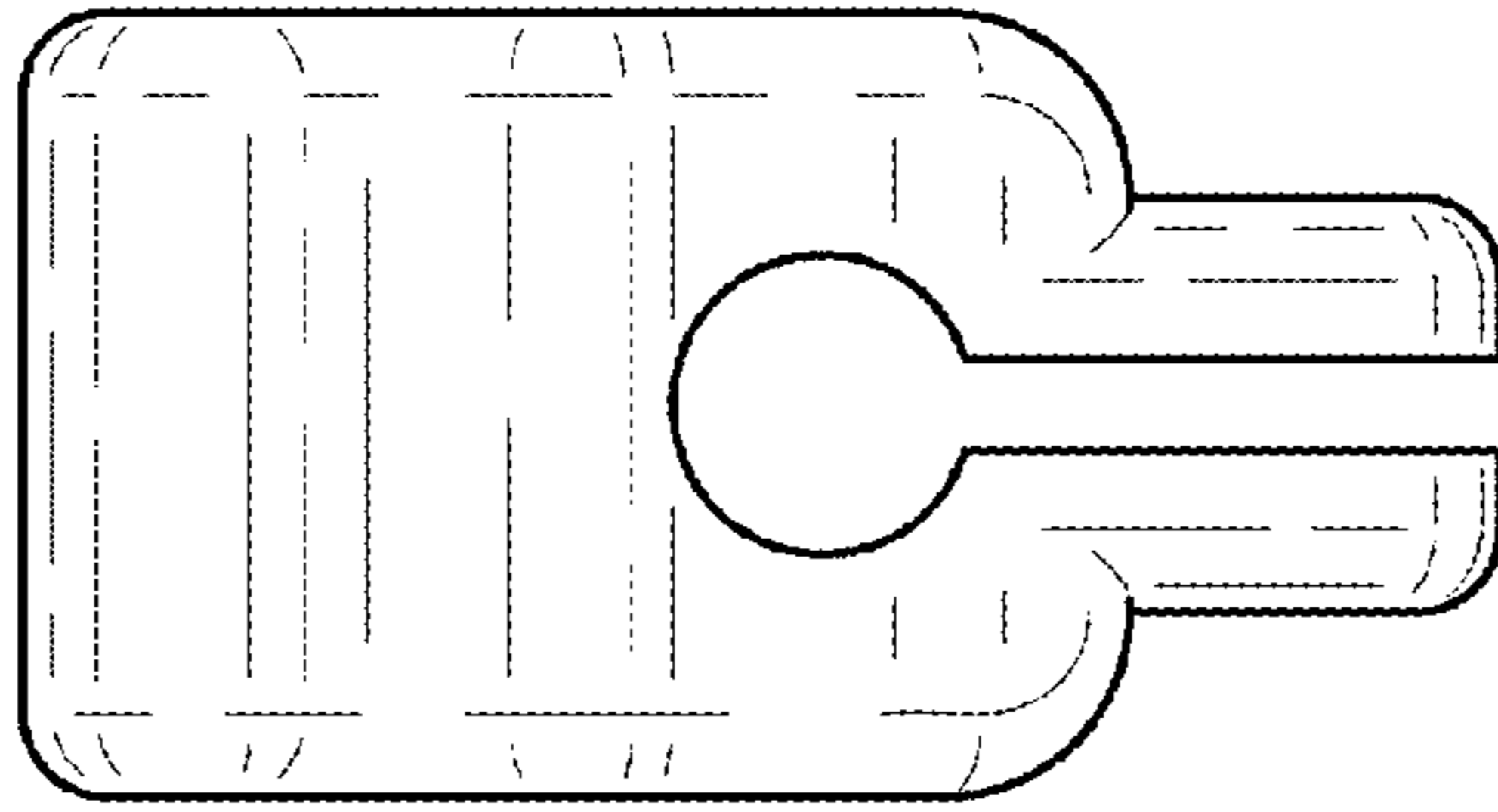

Fig.4

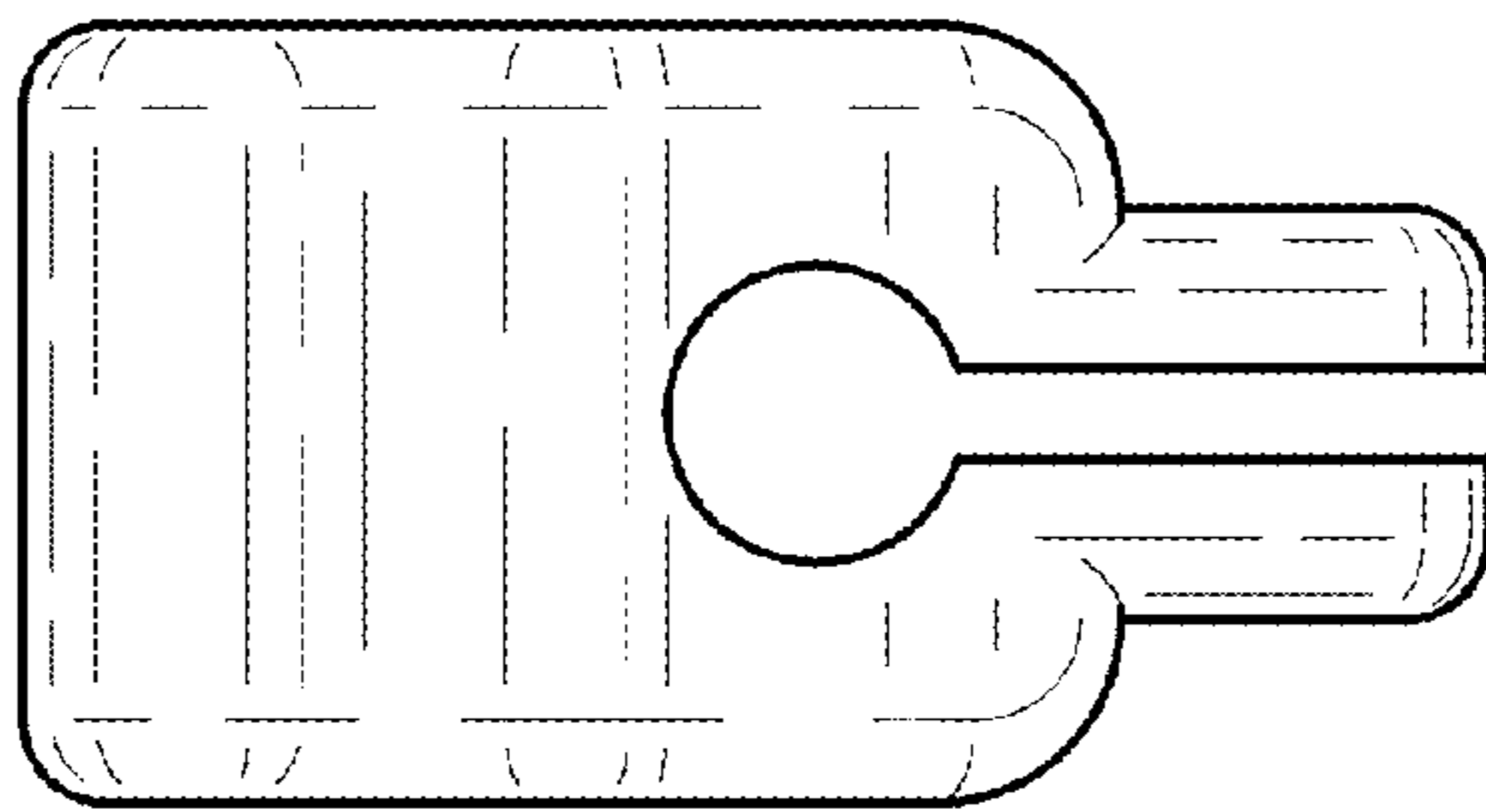

Fig.5

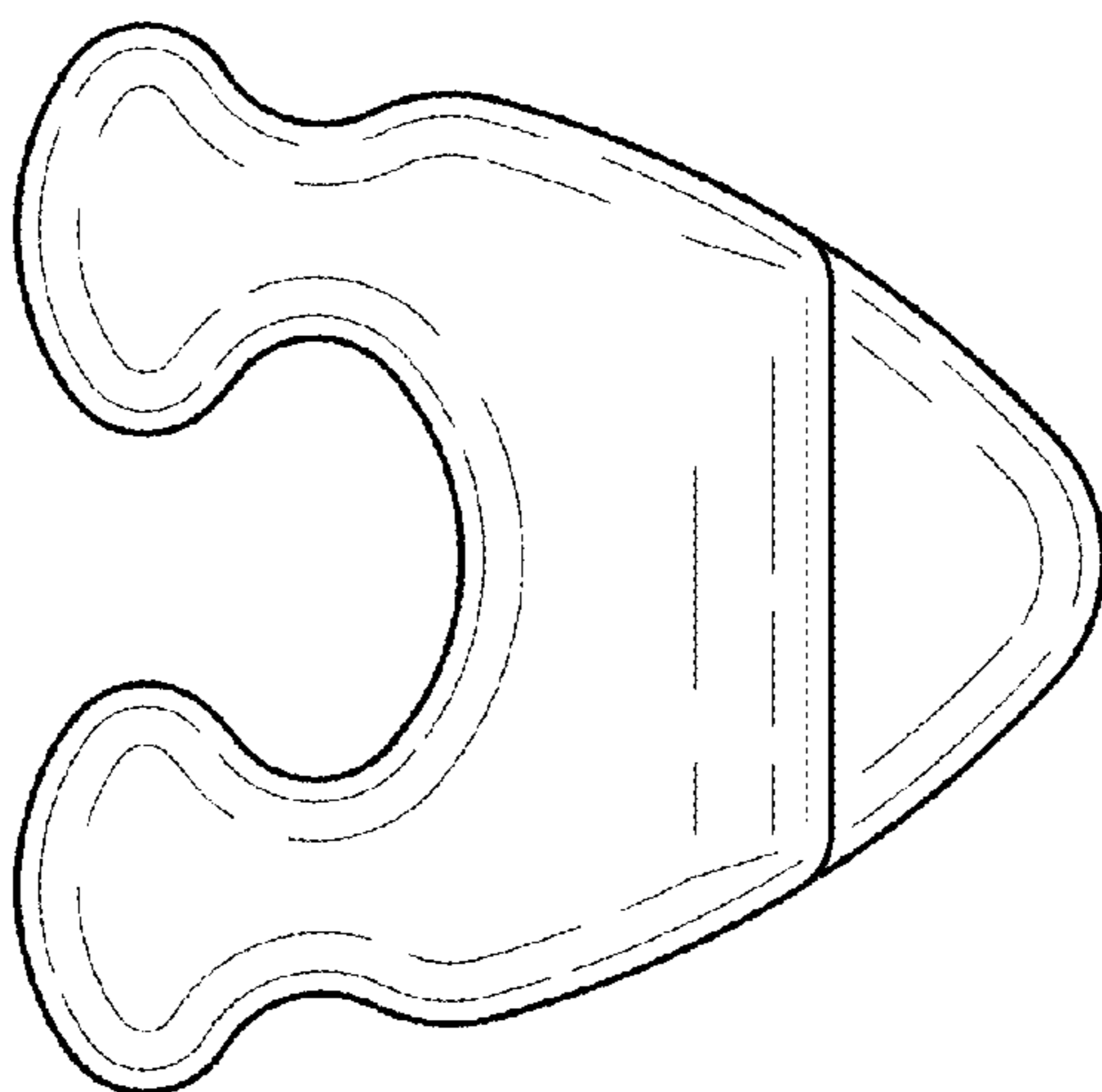

Fig.6

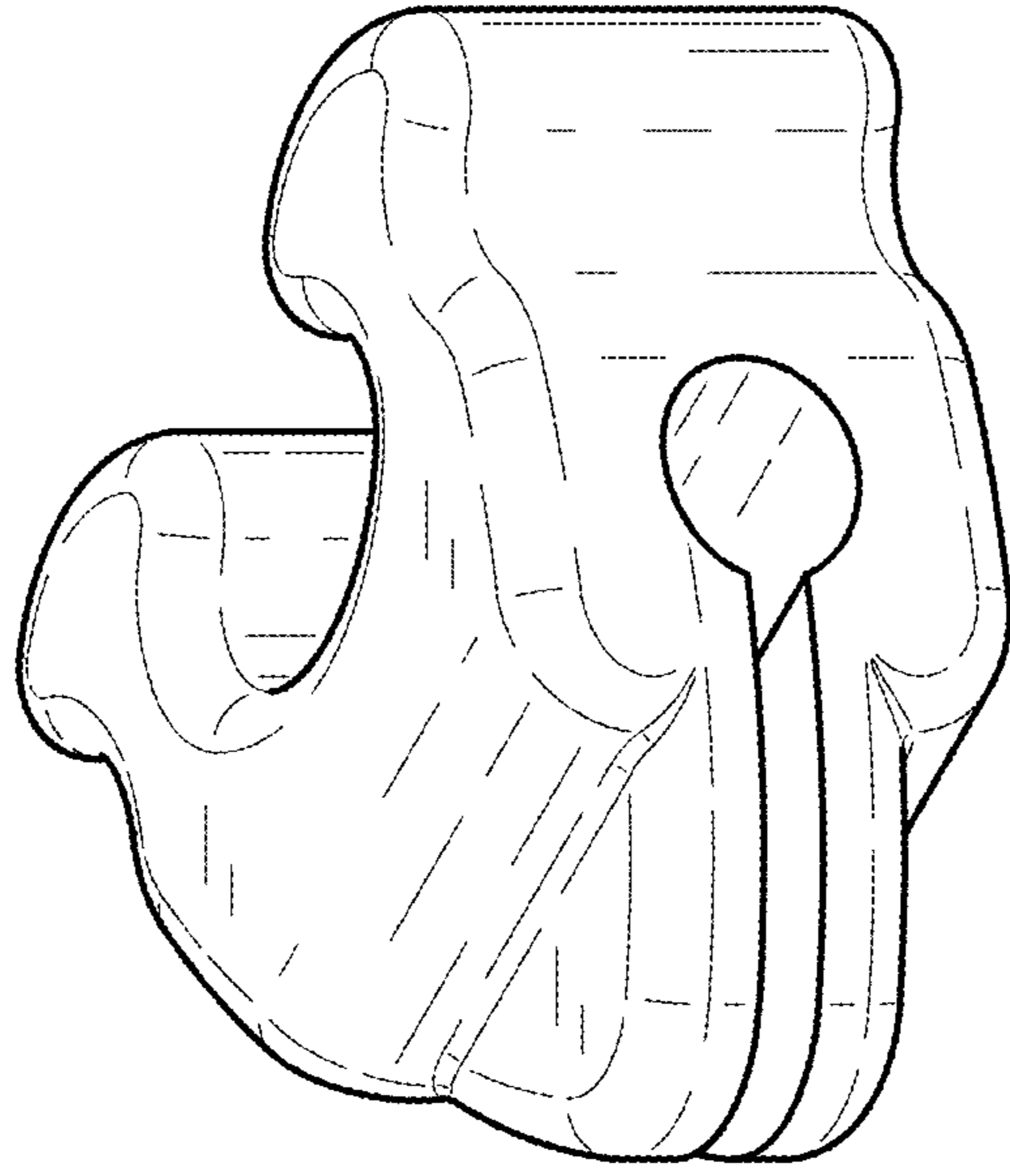

Fig.8

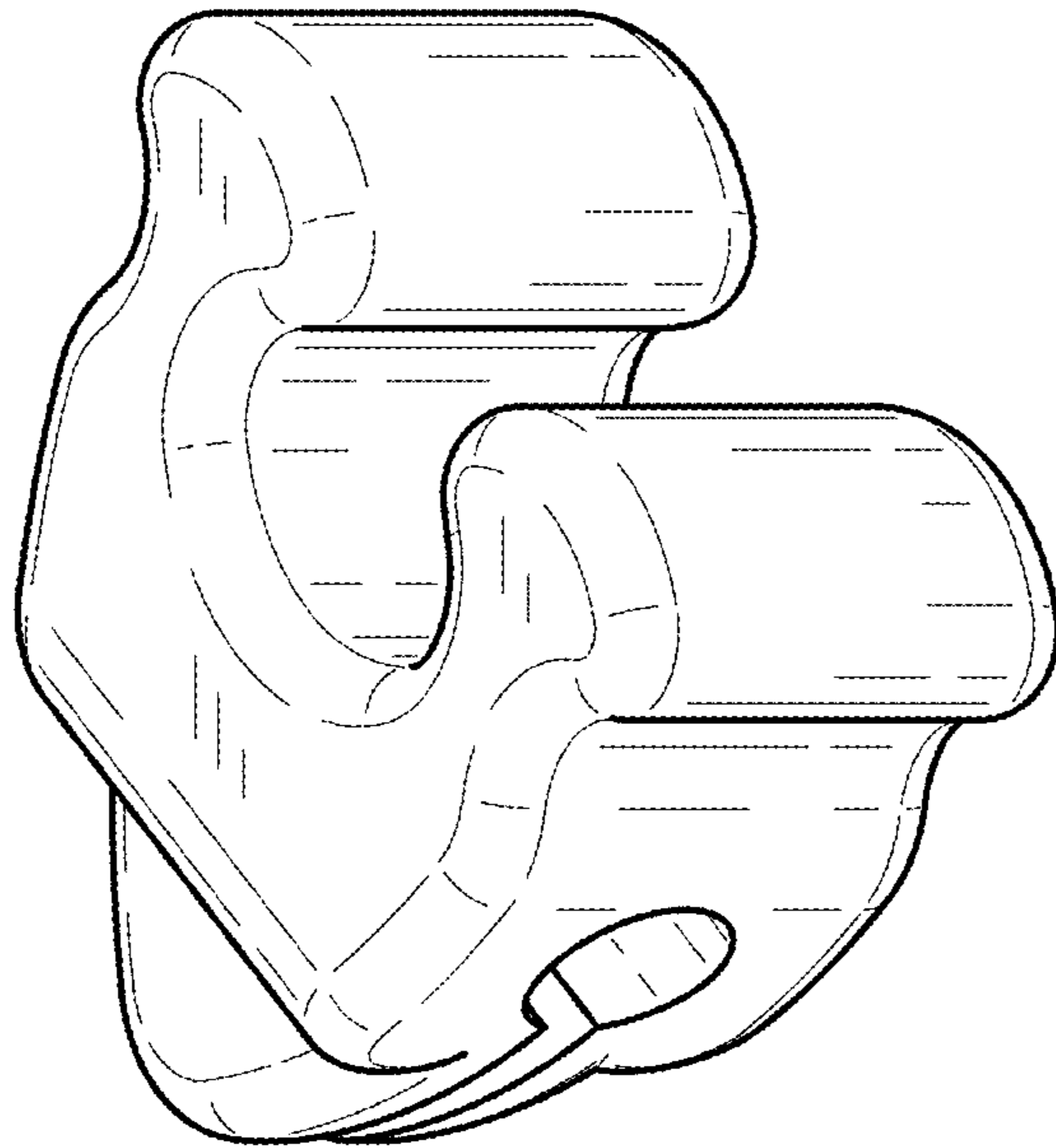

Fig.7

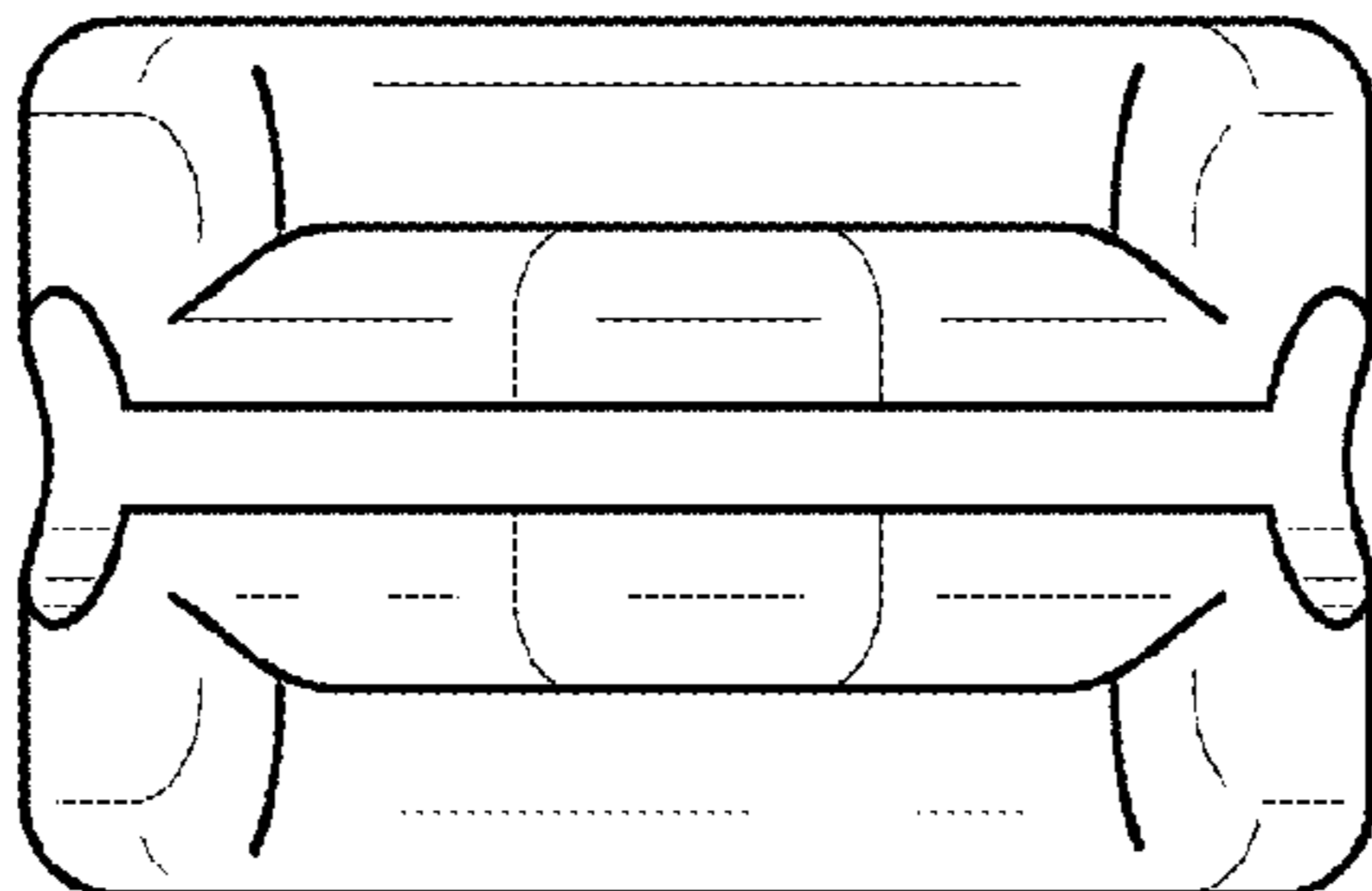

Fig.11

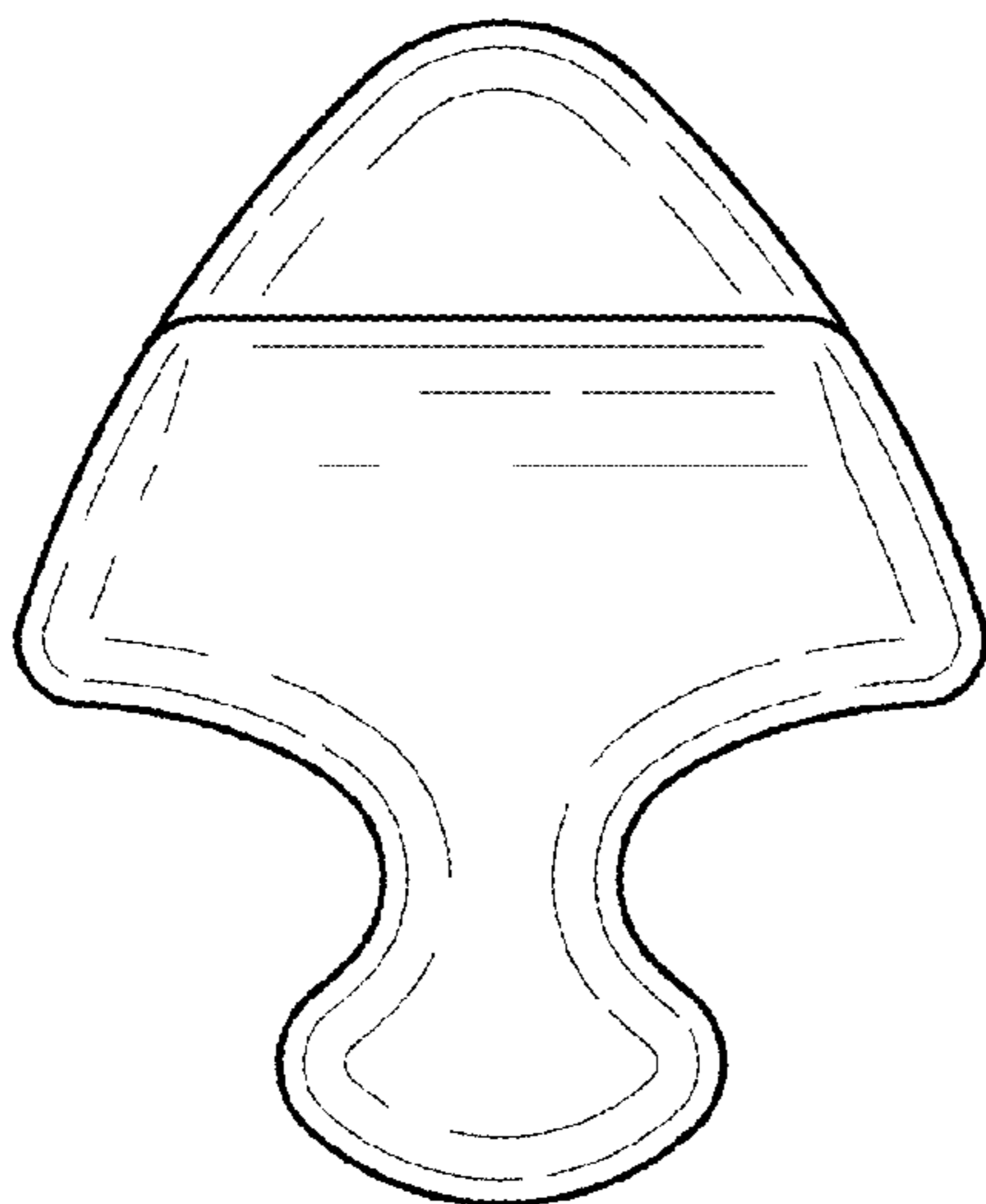

Fig.10

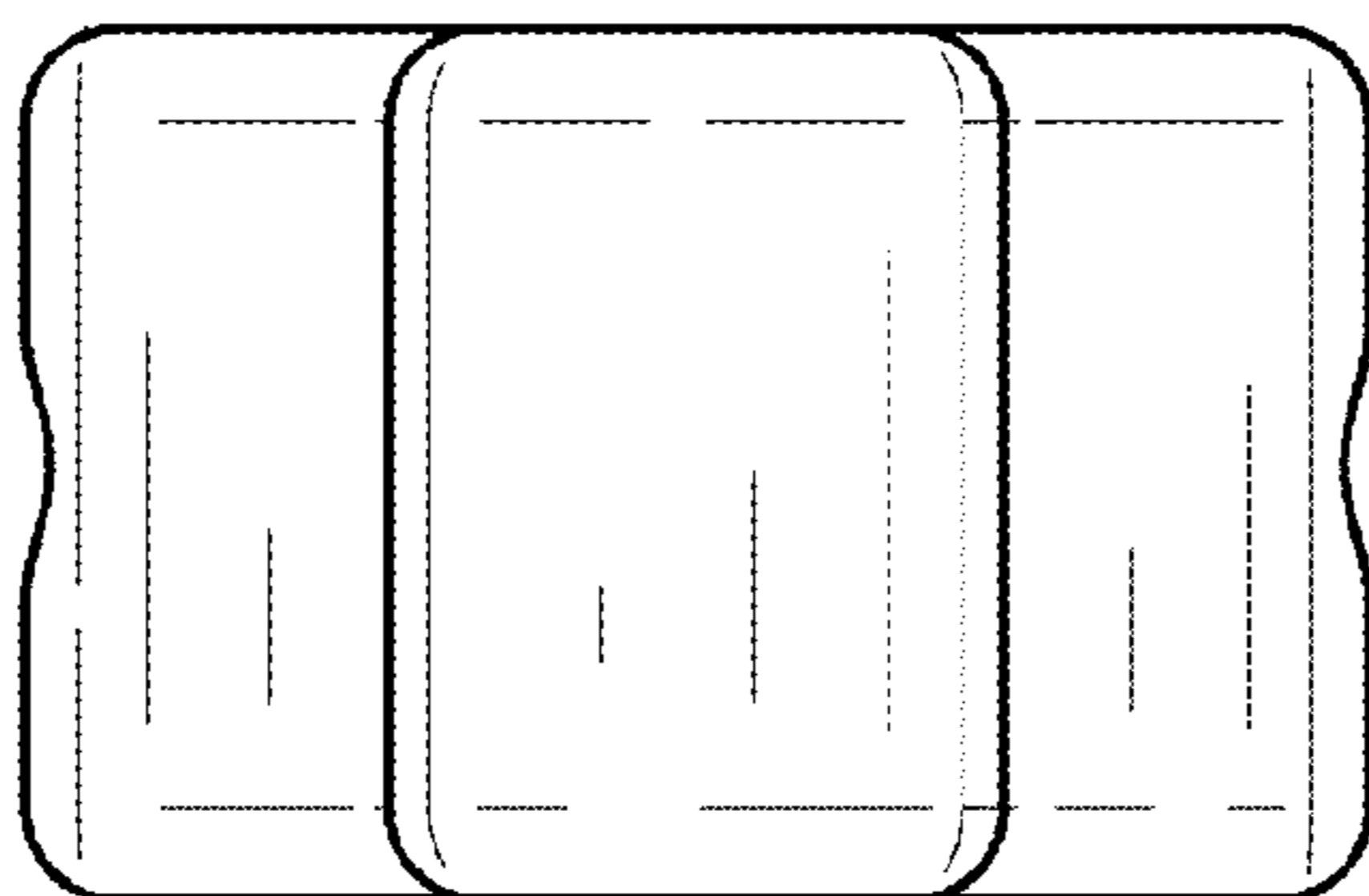

Fig.9

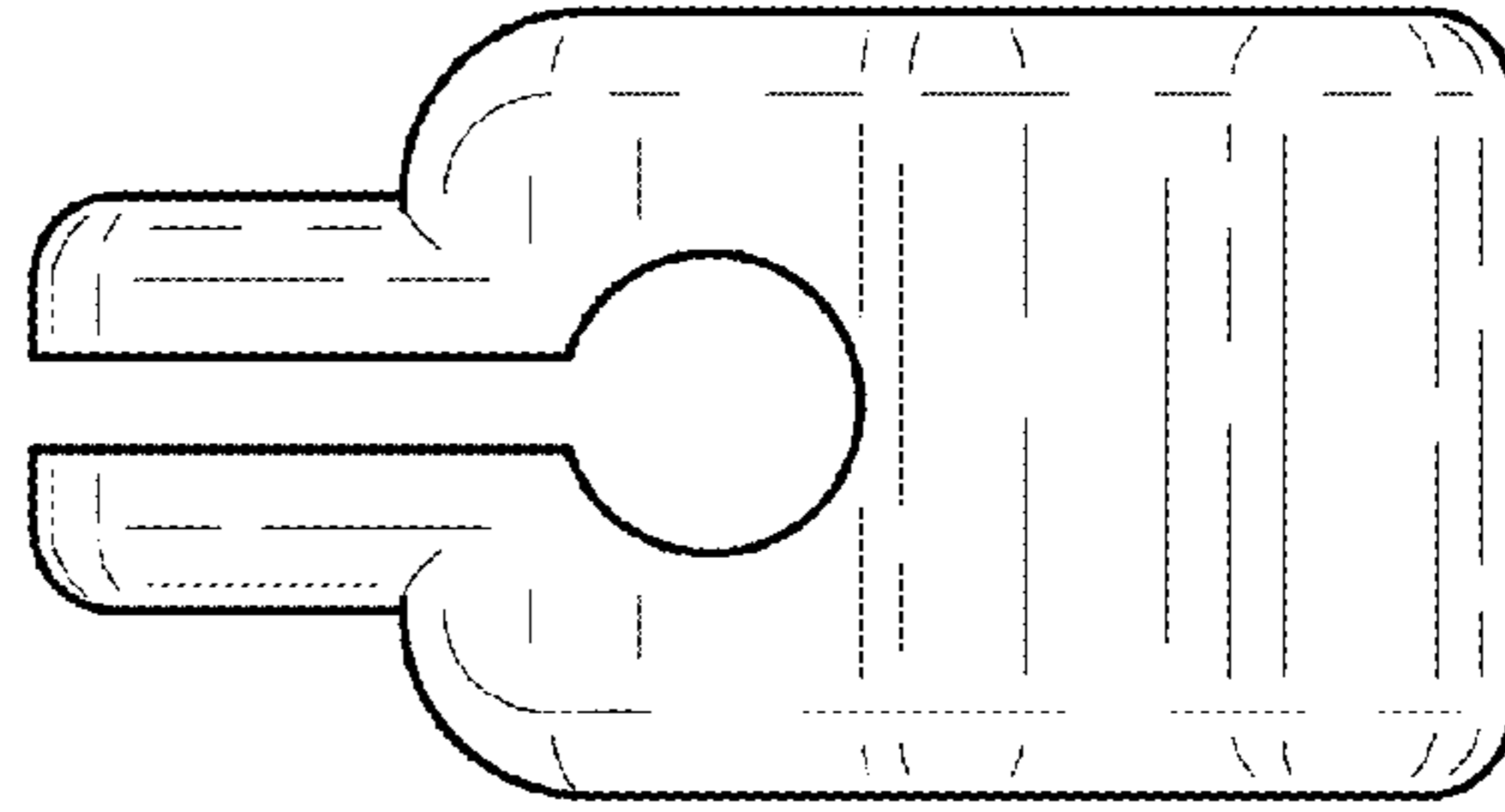

Fig.12

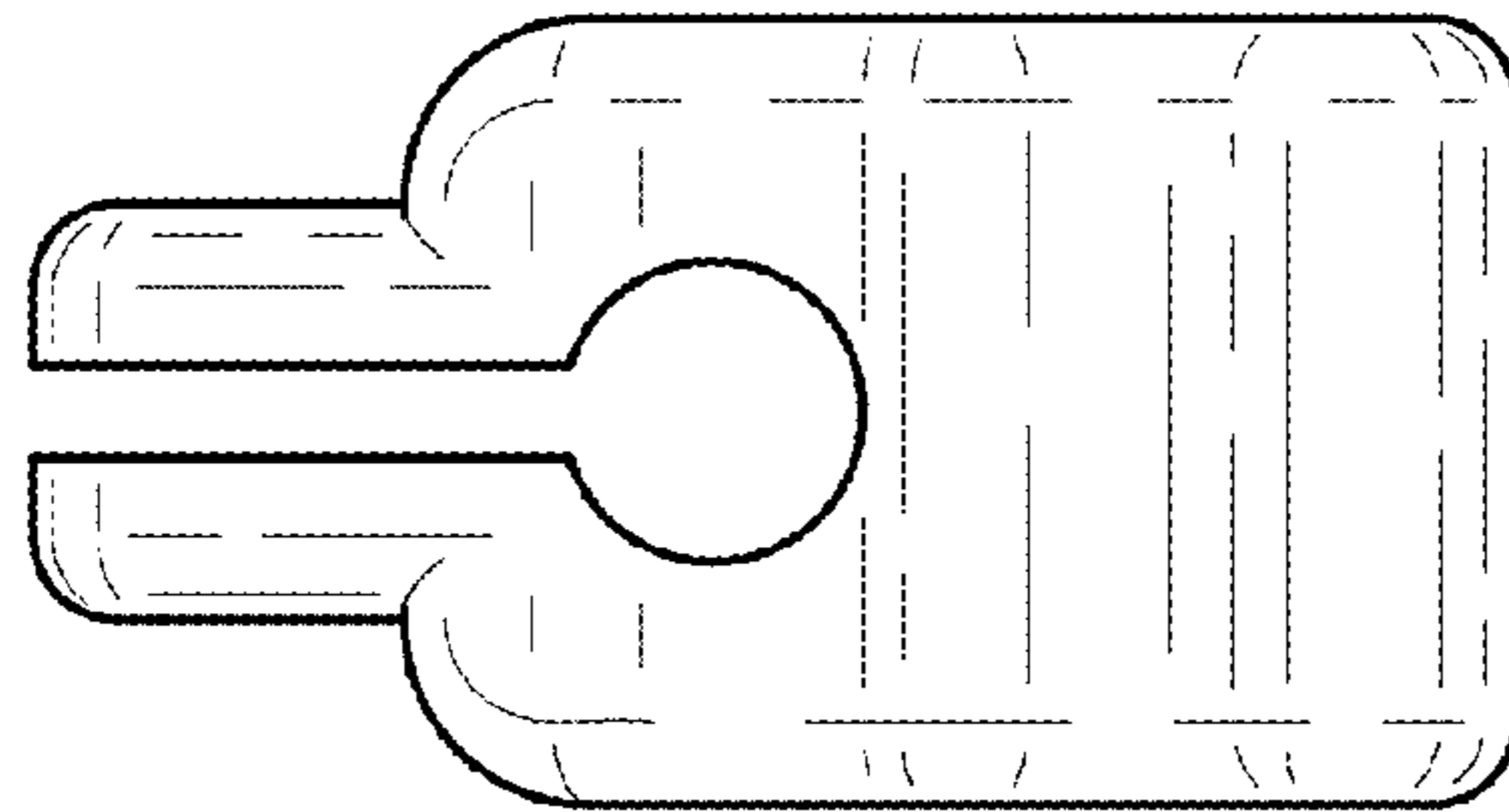

Fig.13

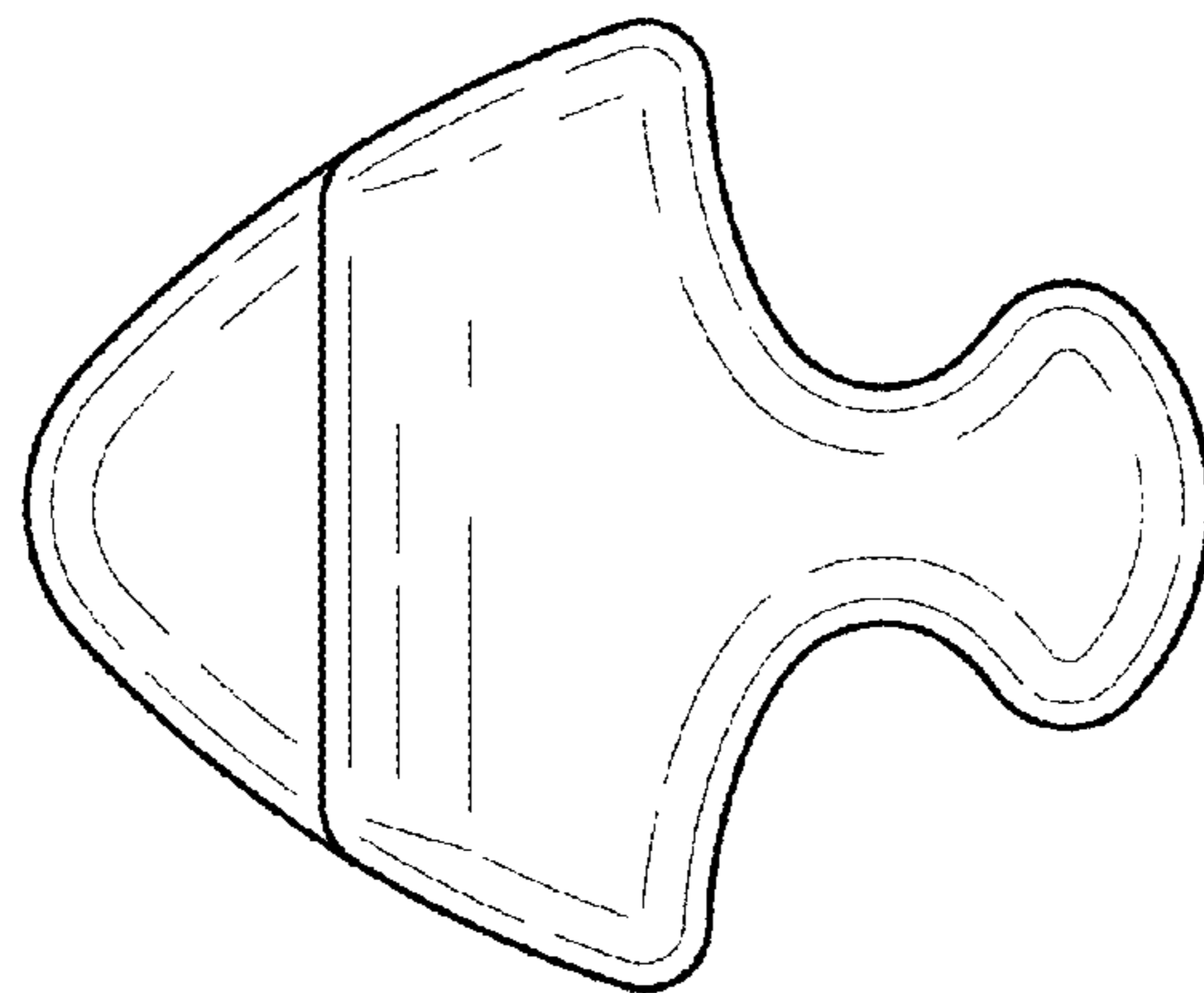

Fig.14

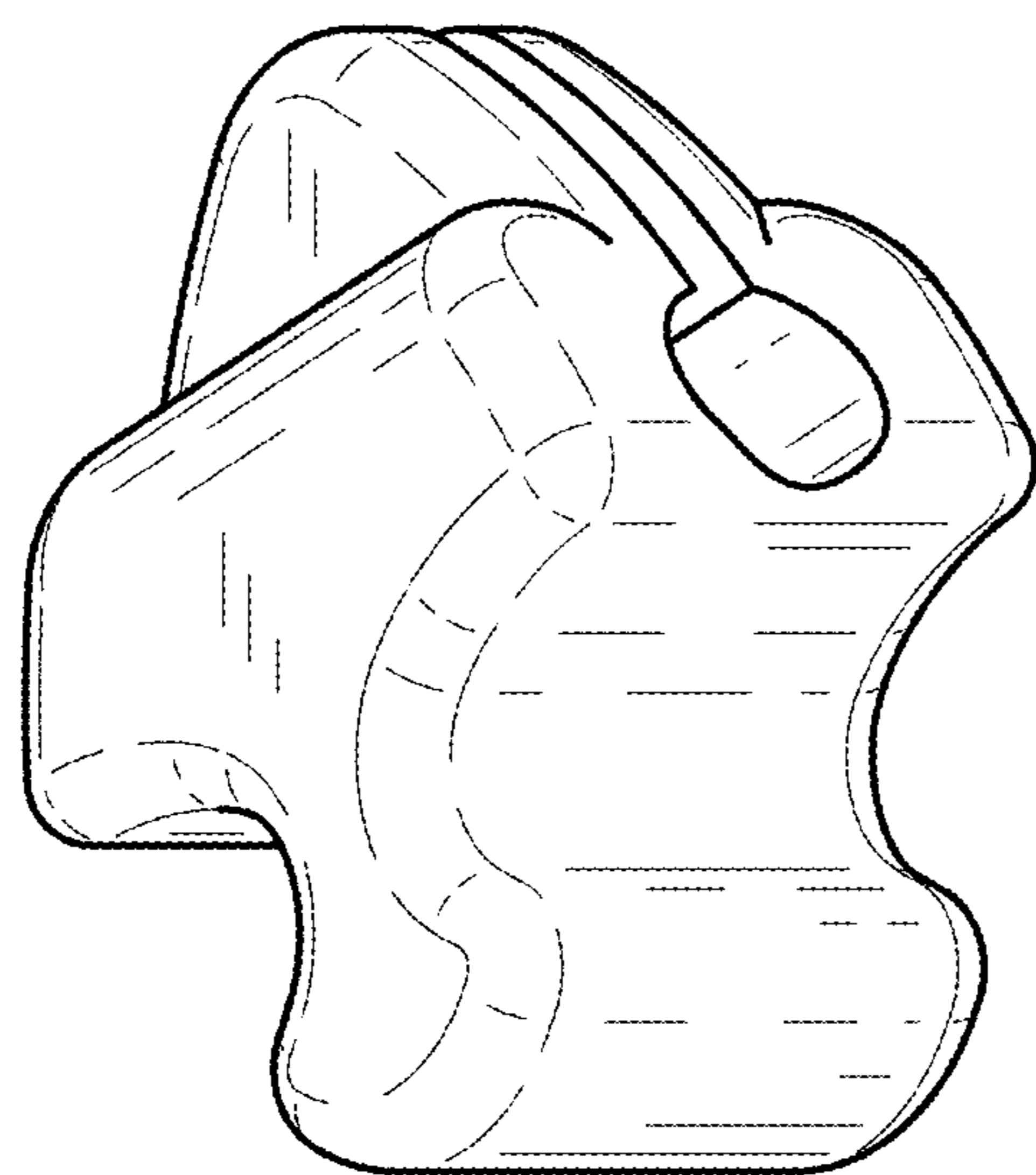

Fig.15

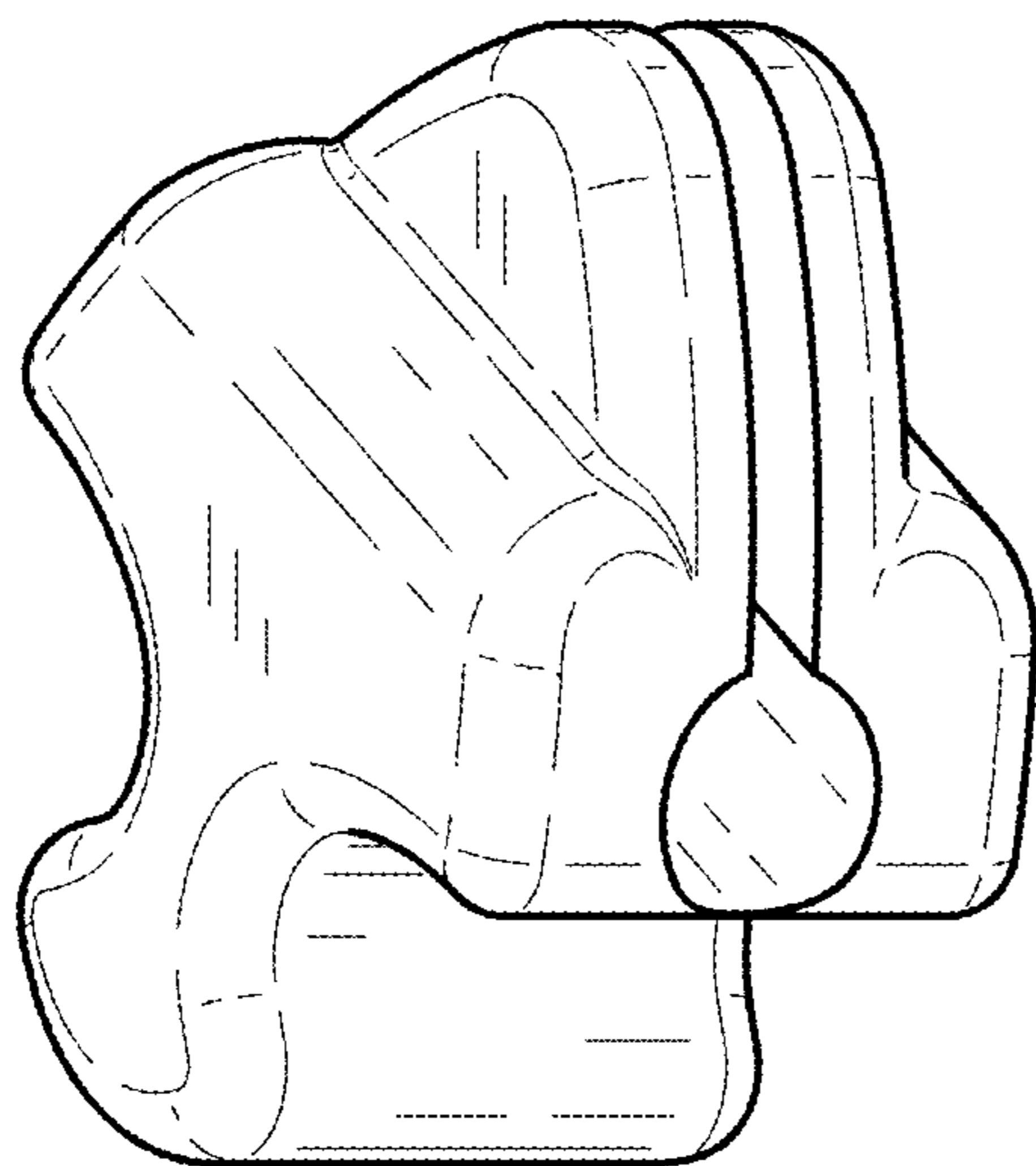

Fig.16

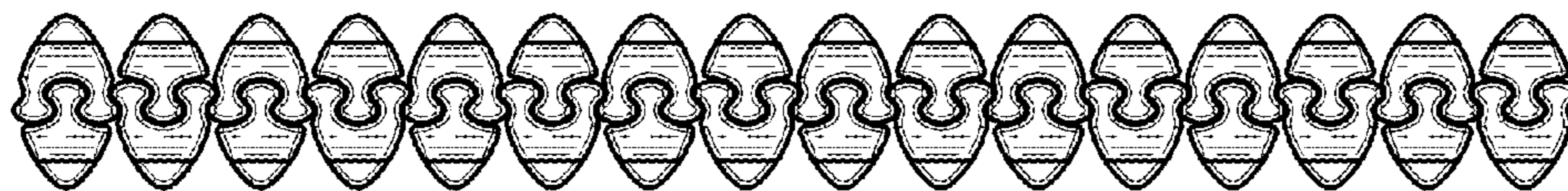

Fig.17

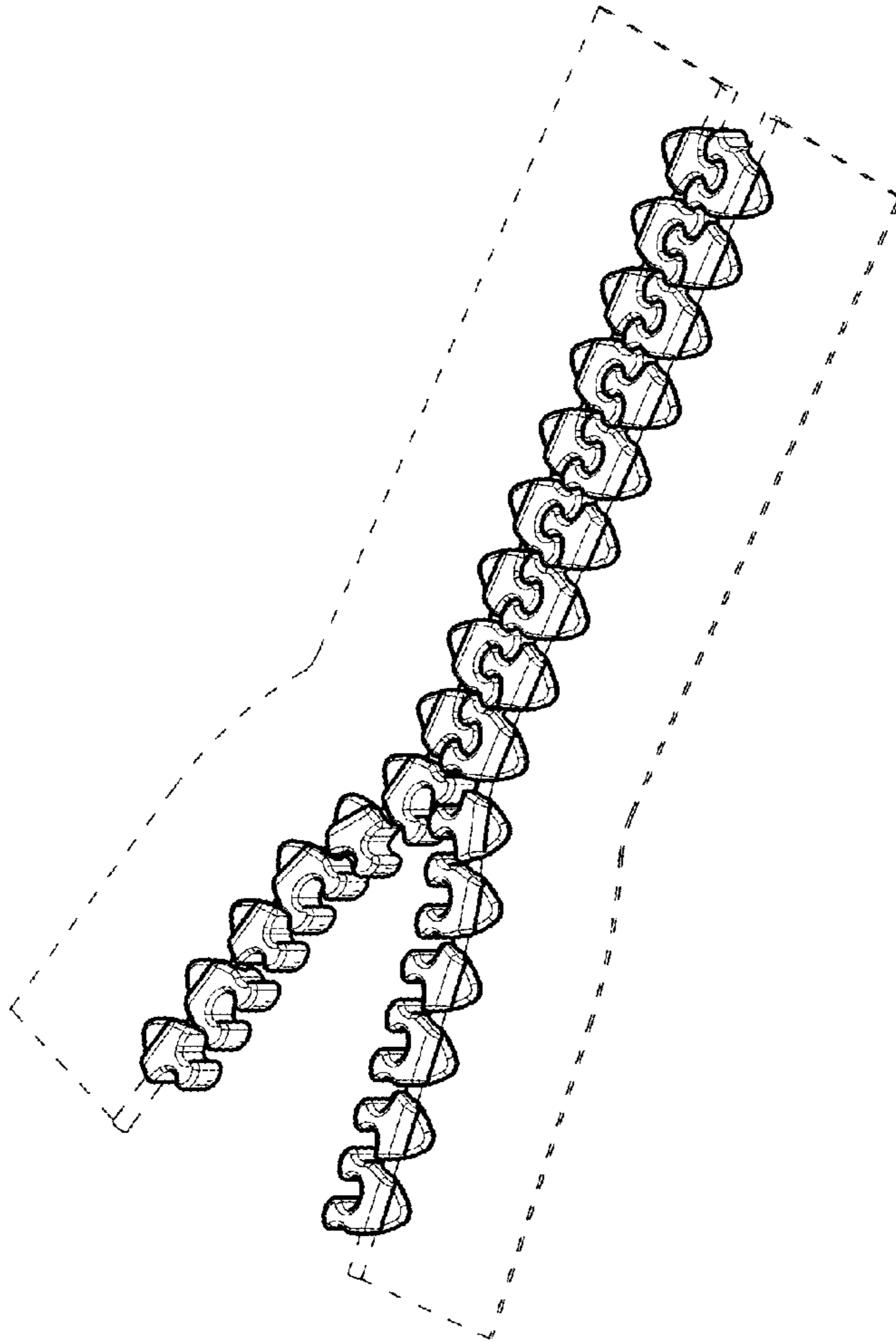

Fig.18