



US00D732423S

(12) **United States Design Patent**
Fildan et al.

(10) **Patent No.:** **US D732,423 S**
(45) **Date of Patent:** **** Jun. 23, 2015**

- (54) **BRASSIERE SHOULDER-STRAP CLOSURE**
- (71) Applicants: **Gerhard Fildan**, Vienna (AT); **Karl Wanzenboeck**, Teesdorf (AT)
- (72) Inventors: **Gerhard Fildan**, Vienna (AT); **Karl Wanzenboeck**, Teesdorf (AT)
- (73) Assignee: **FILDAN ACCESSORIES (HK) LTD**, Kwung Tong Kowloon (HK)
- (**) Term: **14 Years**
- (21) Appl. No.: **29/464,326**
- (22) Filed: **Aug. 15, 2013**
- (51) **LOC (10) Cl.** **02-07**
- (52) **U.S. Cl.**
USPC **D11/218**
- (58) **Field of Classification Search**
USPC D11/1-2, 200-201, 206-210, 214-218, D11/212, 213; 24/163 R, 169-171, 173, 24/177-179, 191, 194-195, 197, 200, 24/614-616, 625, 198, 578.11, 578.1, 24/163 K, 114
CPC A44B 11/00; A44B 11/25; A44B 17/00; A44B 21/00; A41F 19/00; A41F 9/00
See application file for complete search history.

5,671,516	A *	9/1997	Sartori	24/652
D440,906	S *	4/2001	Fildan et al.	D11/218
D445,723	S *	7/2001	Kim	D11/218
6,435,940	B1 *	8/2002	Fildan et al.	450/86
D475,653	S *	6/2003	Fildan et al.	D11/216
6,684,463	B1 *	2/2004	Yang	24/197
D612,765	S *	3/2010	Fildan et al.	D11/218
8,225,468	B2 *	7/2012	Wanzenboeck	24/586.11
D666,525	S *	9/2012	Anderson et al.	D11/218
D715,184	S *	10/2014	Howard McElroy	D11/200

* cited by examiner

Primary Examiner — Ralf Seifert

(74) *Attorney, Agent, or Firm* — Andrew Wilford

(57) **CLAIM**

The ornamental design for a brassiere shoulder-strap closure, as shown and described.

DESCRIPTION

FIG. 1 is front perspective view from above of a half of the closure of this invention that is formed by two identical such halves;

FIG. 2 is a front elevational view of the closure half;

FIG. 3 is a side elevational view of the closure half, both side views being mirror-symmetrical identical;

FIG. 4 is a back elevational view of the closure half;

FIG. 5 is a bottom view of the closure half;

FIG. 6 is a front perspective view of the closure of this invention formed by two of the halves of FIGS. 1-5;

FIG. 7 is a front elevational view of the closure;

FIG. 8 is a side elevational view of the closure, both side views being mirror-symmetrical identical;

FIG. 9 is a back elevational view of the closure;

FIG. 10 is a bottom view of the closure;

FIGS. 11-20 are views corresponding to FIGS. 1-10 of a second embodiment of the closure;

FIGS. 21-30 are views corresponding to FIGS. 1-10 of a third embodiment of the closure; and,

FIGS. 31-40 are views corresponding to FIGS. 1-10 of a fourth embodiment of the closure.

1 Claim, 4 Drawing Sheets

(56) **References Cited**

U.S. PATENT DOCUMENTS

D34,265	S *	3/1901	Holmes	D11/216
D53,302	S *	5/1919	Hausen	D11/218
D77,435	S *	1/1929	Rigold	D11/218
D217,895	S *	6/1970	Burleson	D11/218
3,520,033	A *	7/1970	Genji	24/590.1
3,765,062	A *	10/1973	Cruse	24/587.12
4,413,383	A *	11/1983	Spalding	24/164
D274,862	S *	7/1984	Fildan	D11/208
5,177,837	A *	1/1993	Rekuc	24/198
5,261,257	A *	11/1993	Collier	70/456 R
D349,473	S *	8/1994	Fildan	D11/212
5,432,985	A *	7/1995	Bernart	24/265 AL

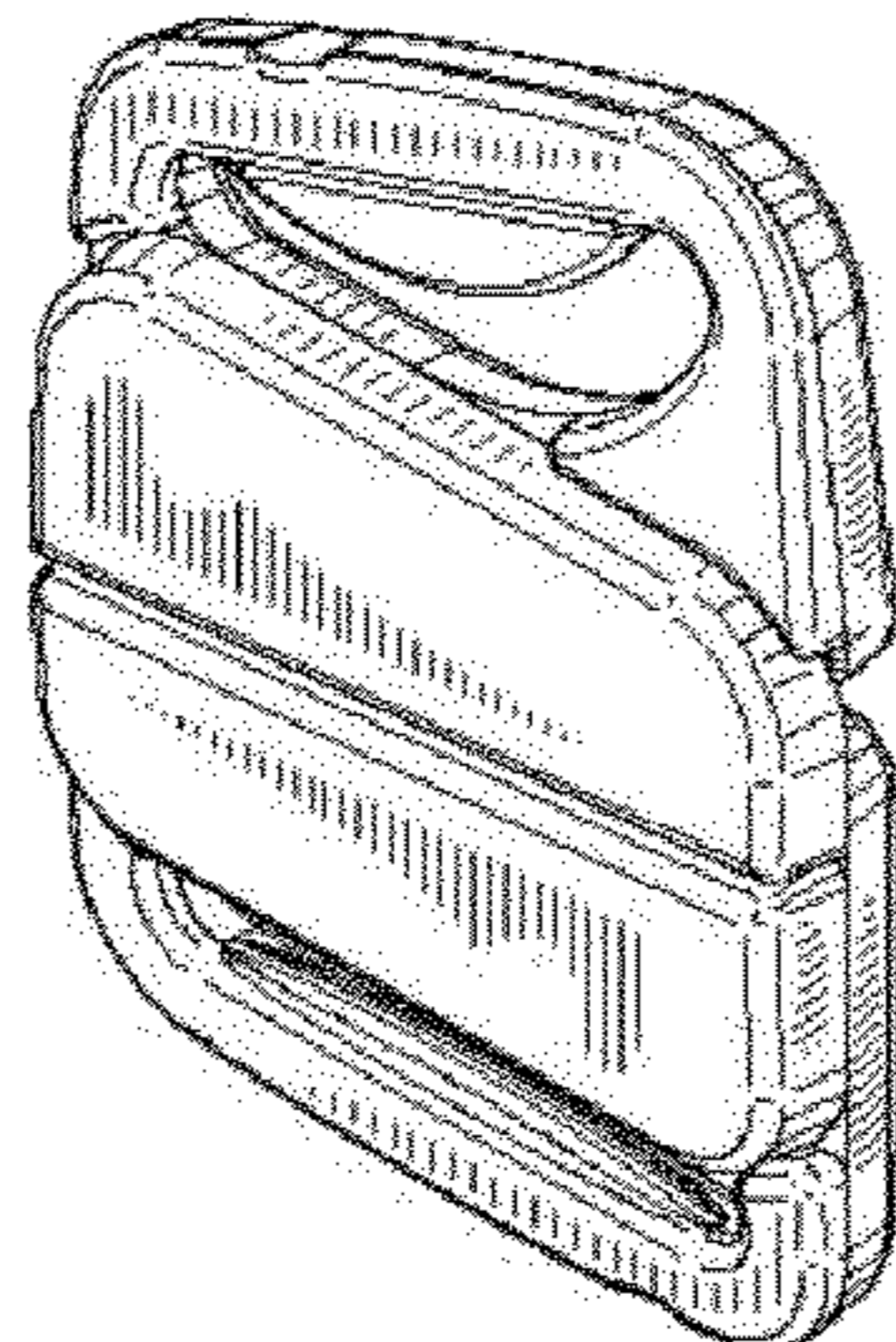

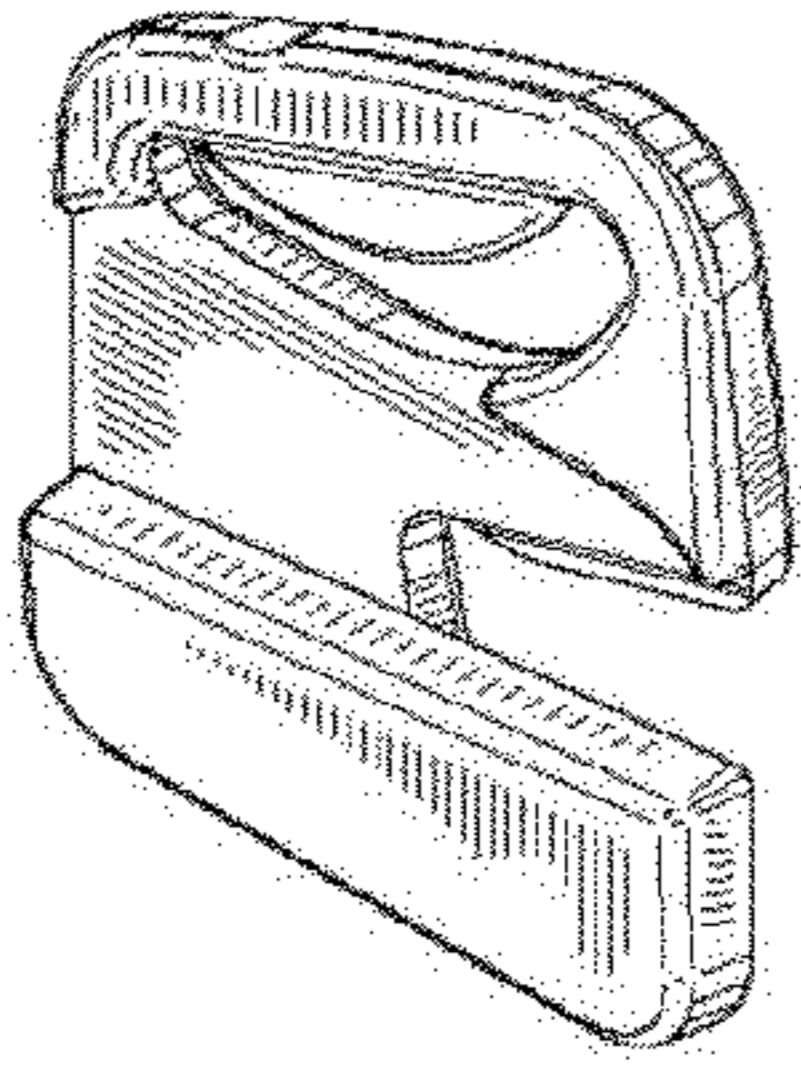

FIG. 1

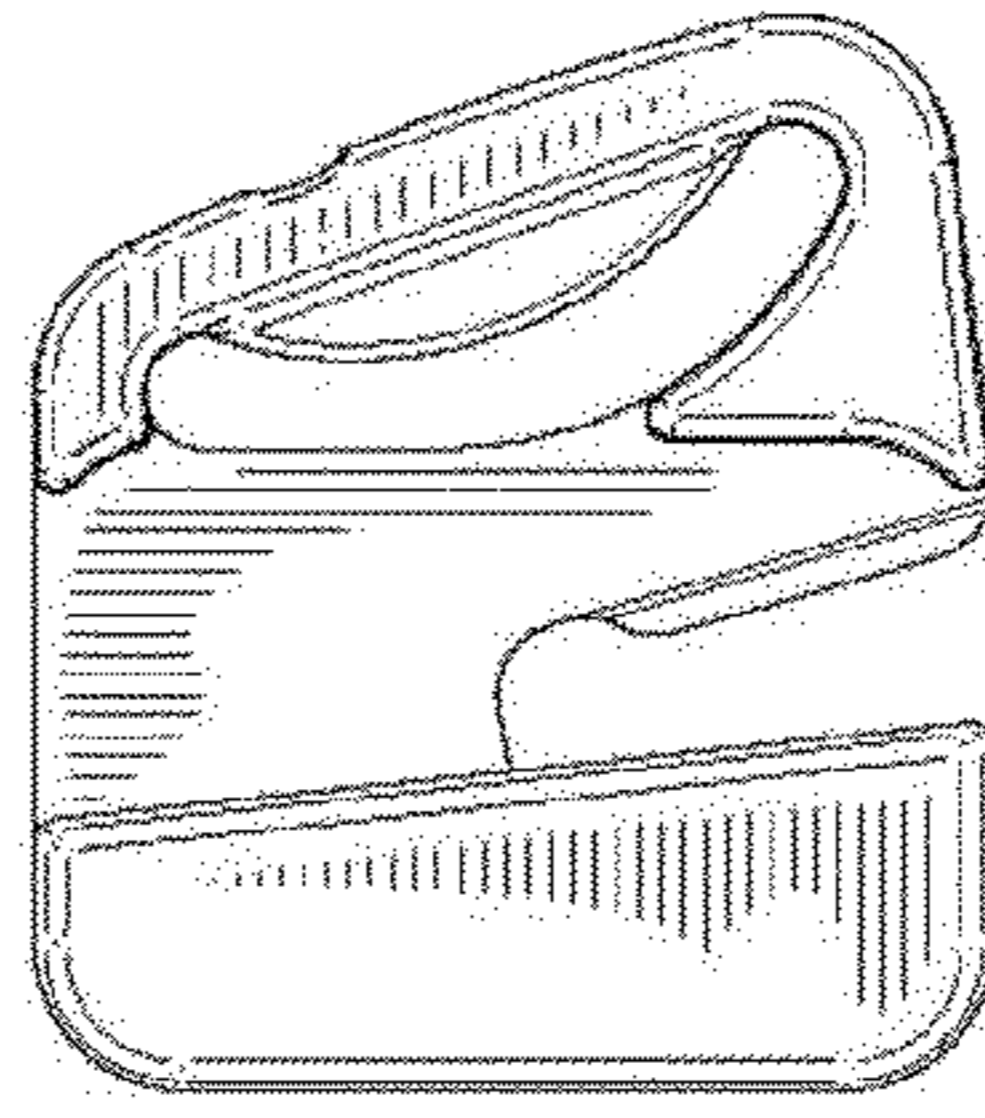

FIG. 2



FIG. 3

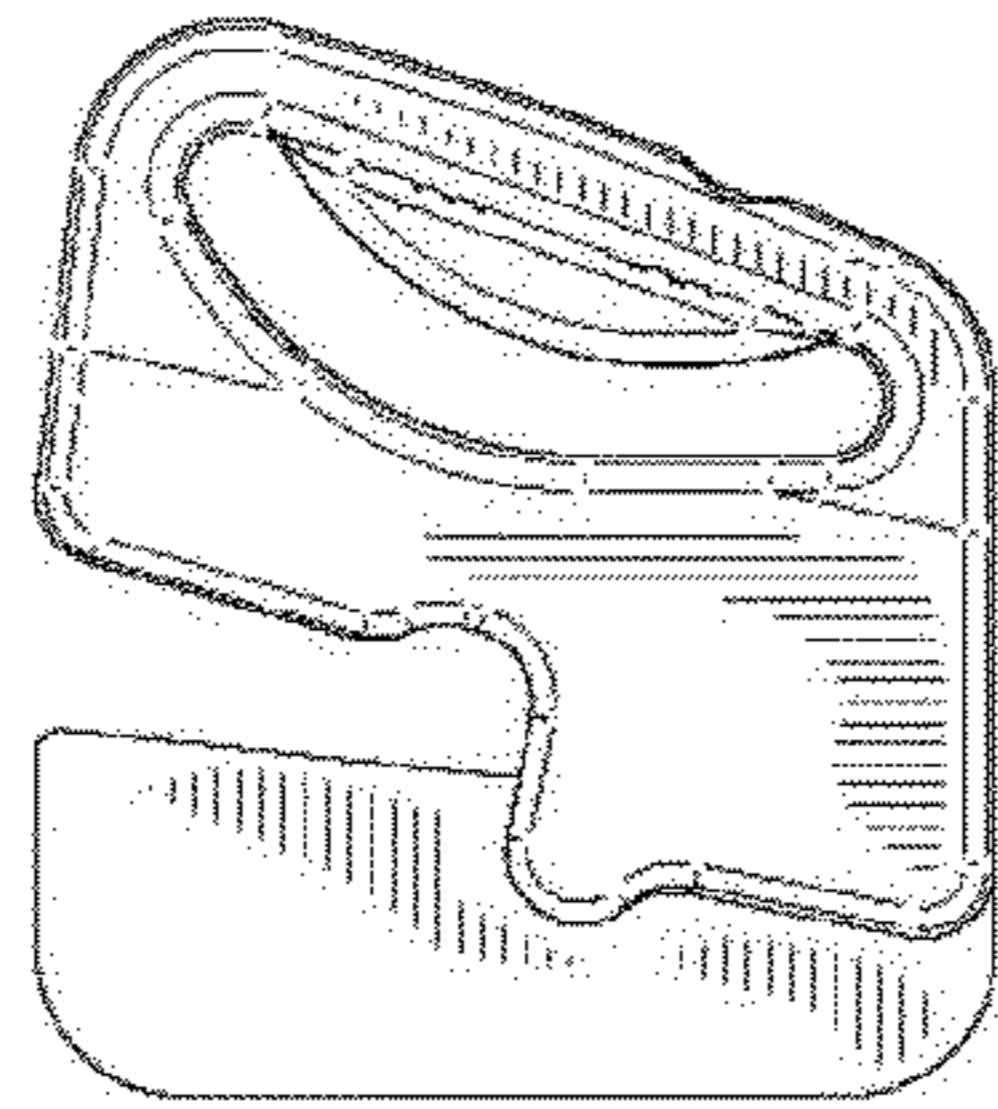

FIG. 4

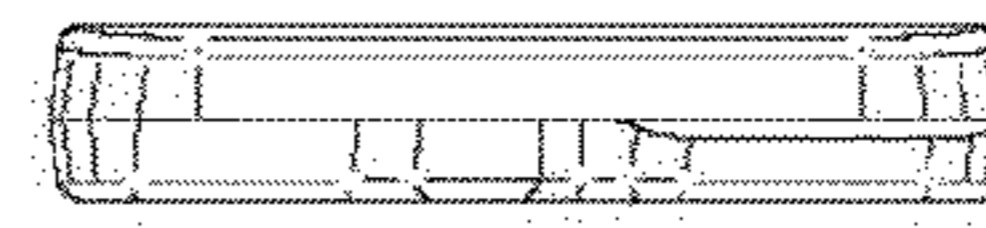

FIG. 5

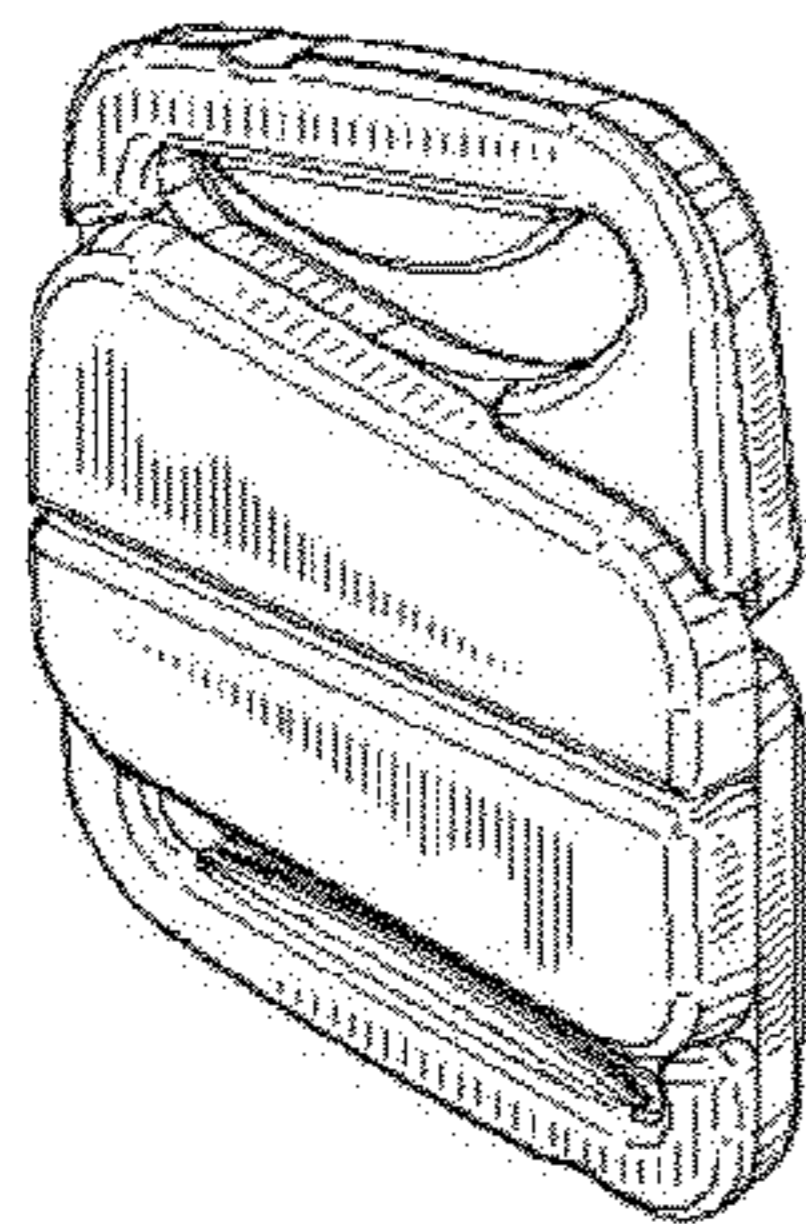

FIG. 6

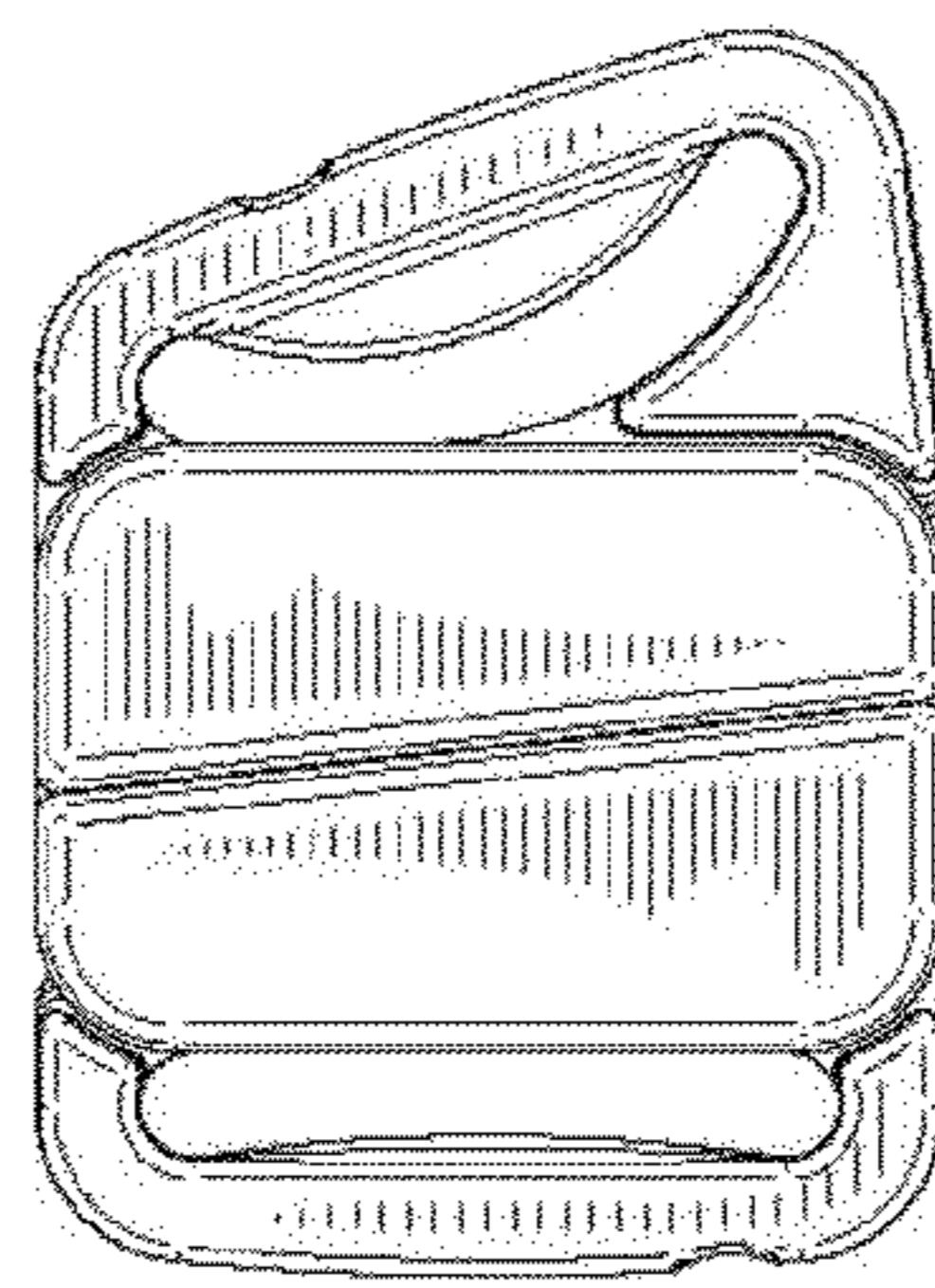

FIG. 7

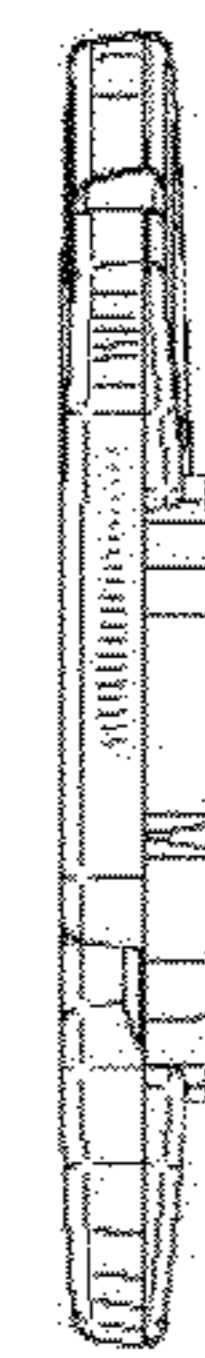

FIG. 8

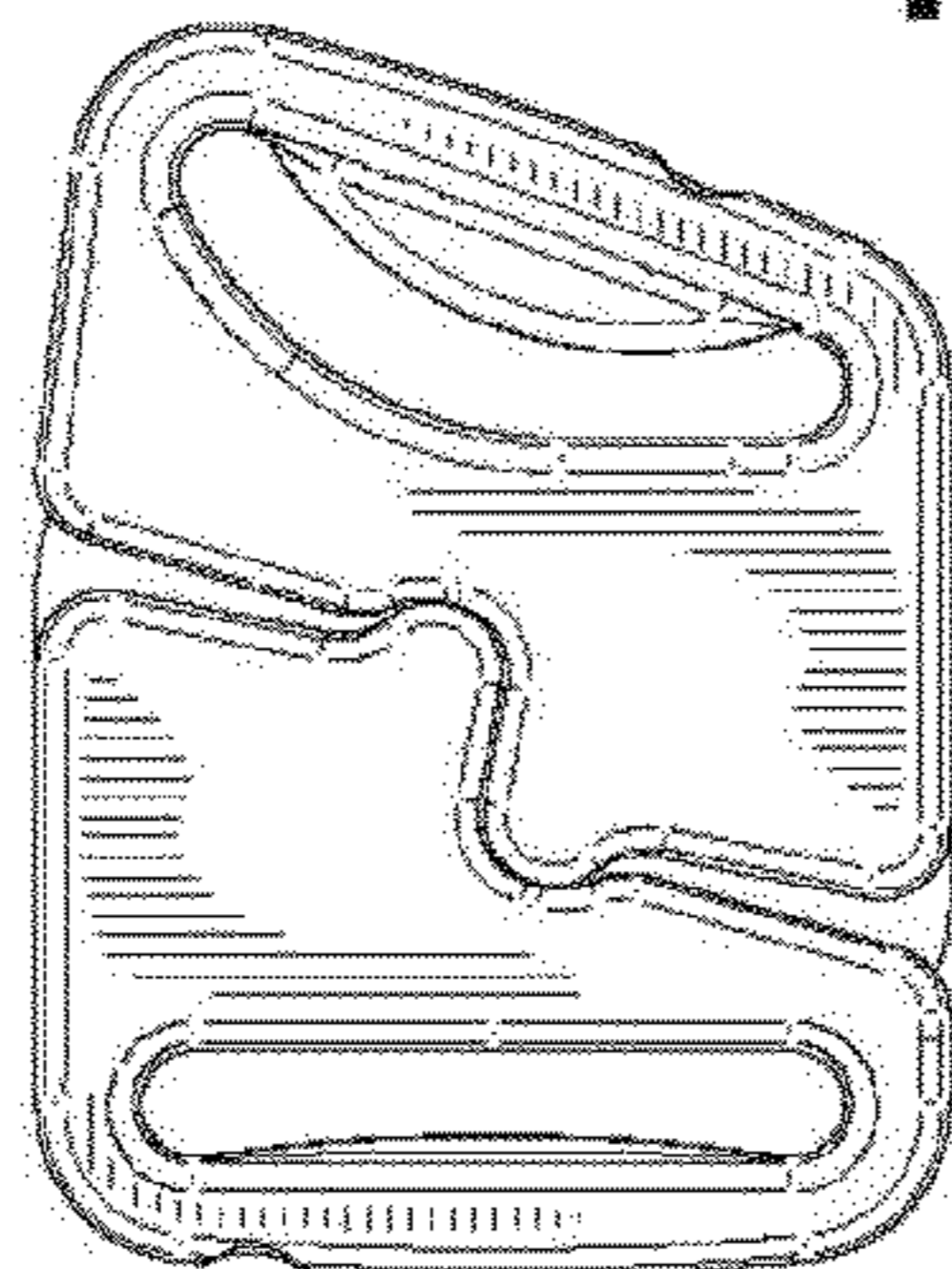

FIG. 9



FIG. 10

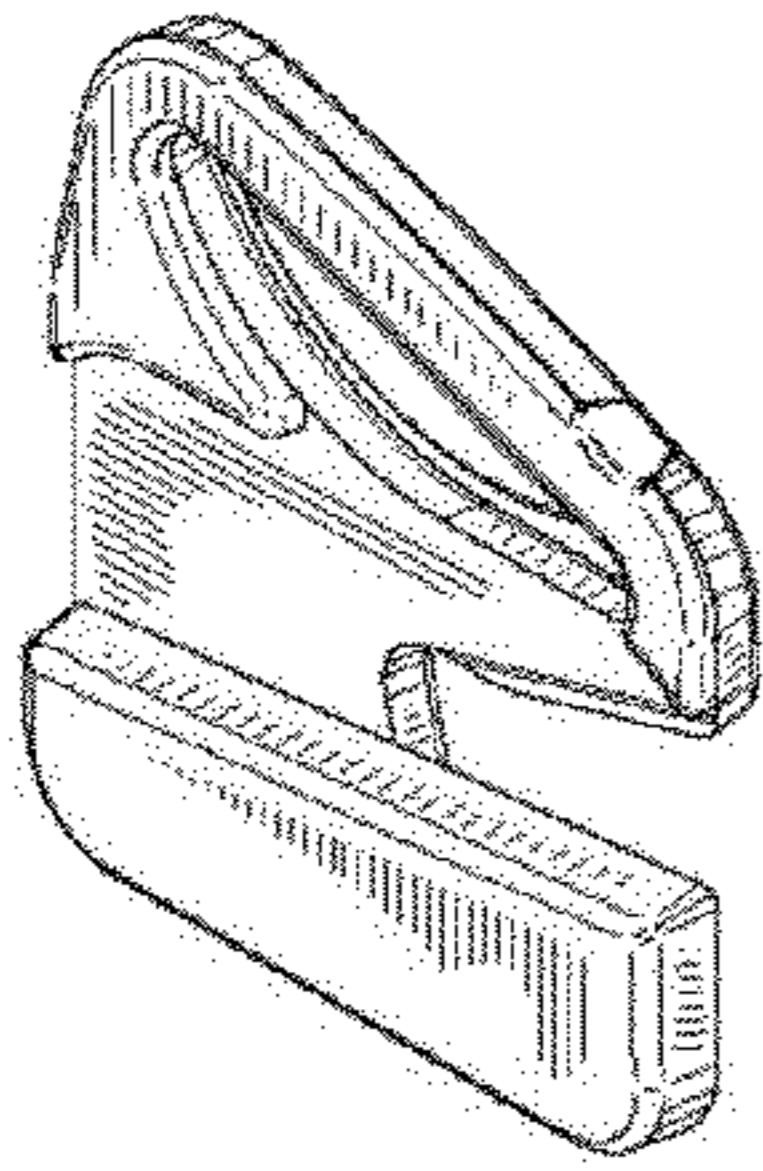

FIG. 11

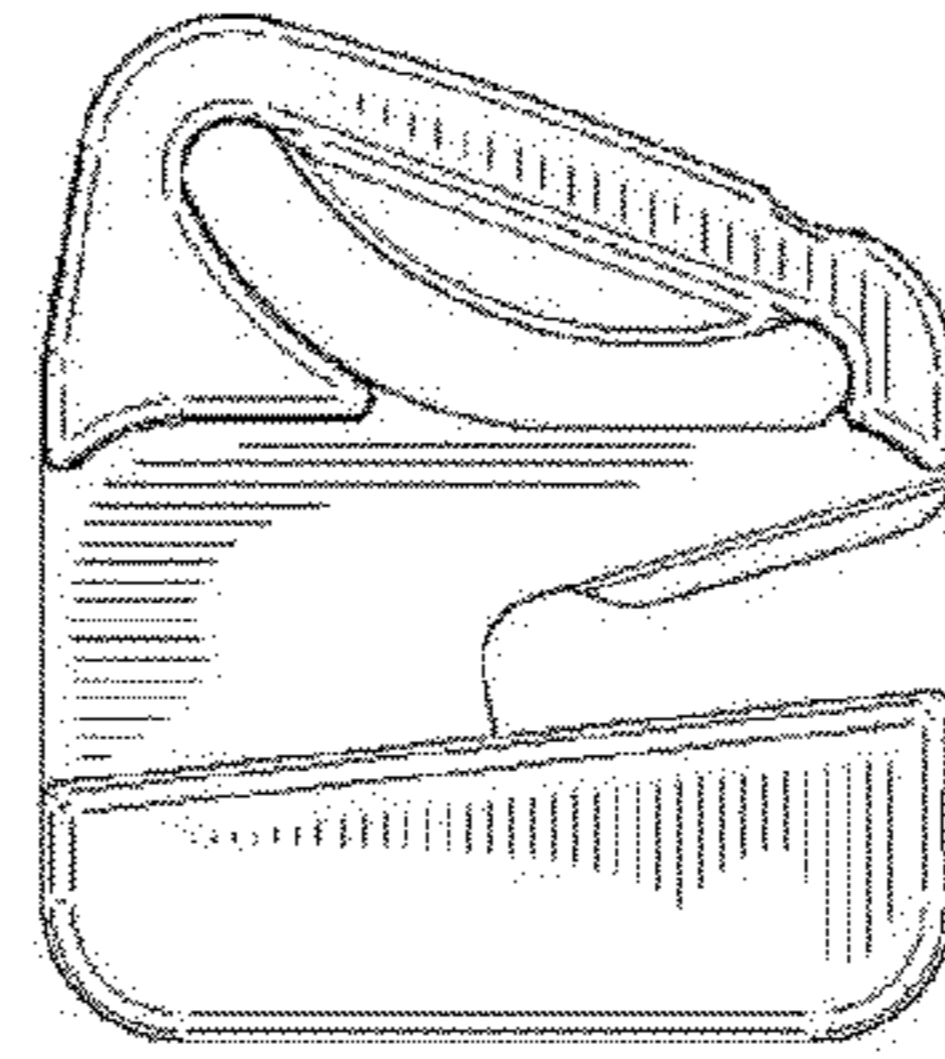

FIG. 12

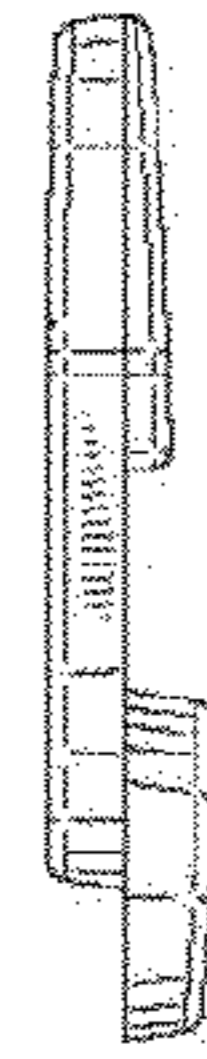

FIG. 13

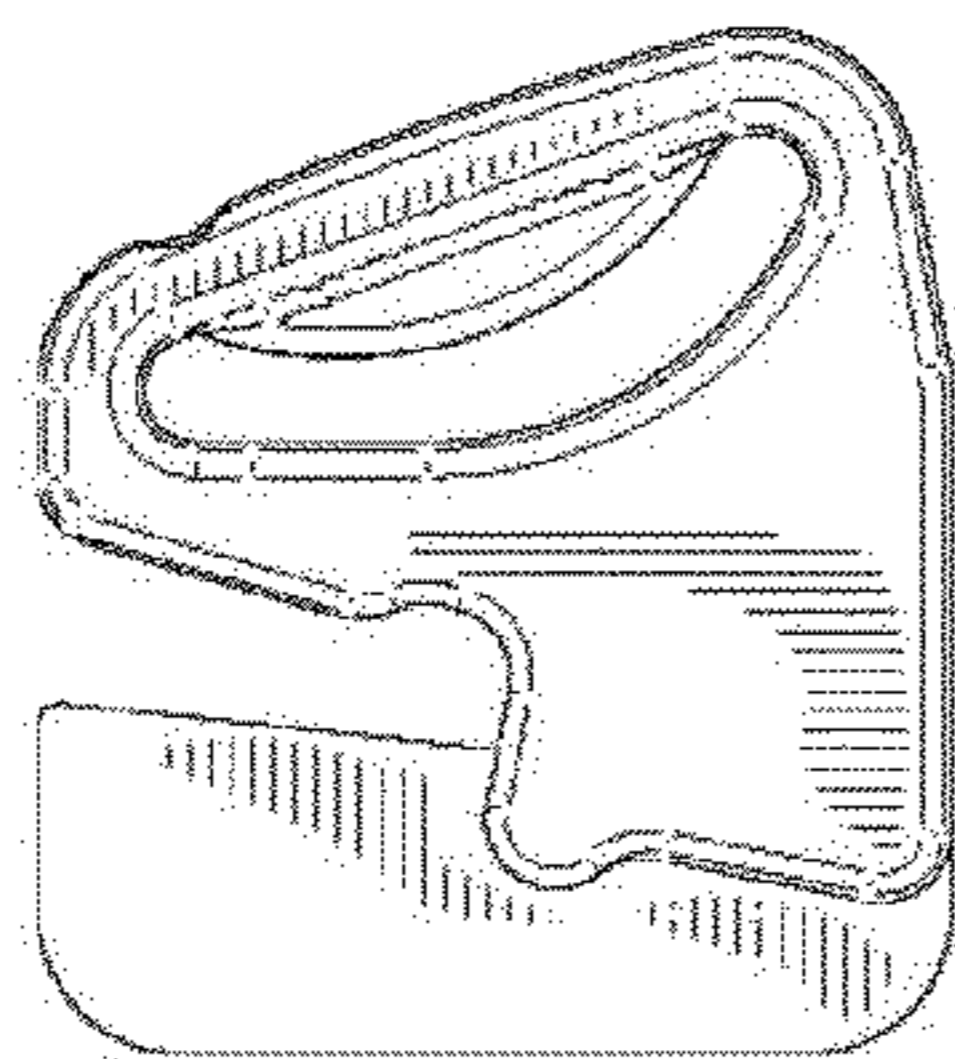

FIG. 14



FIG. 15

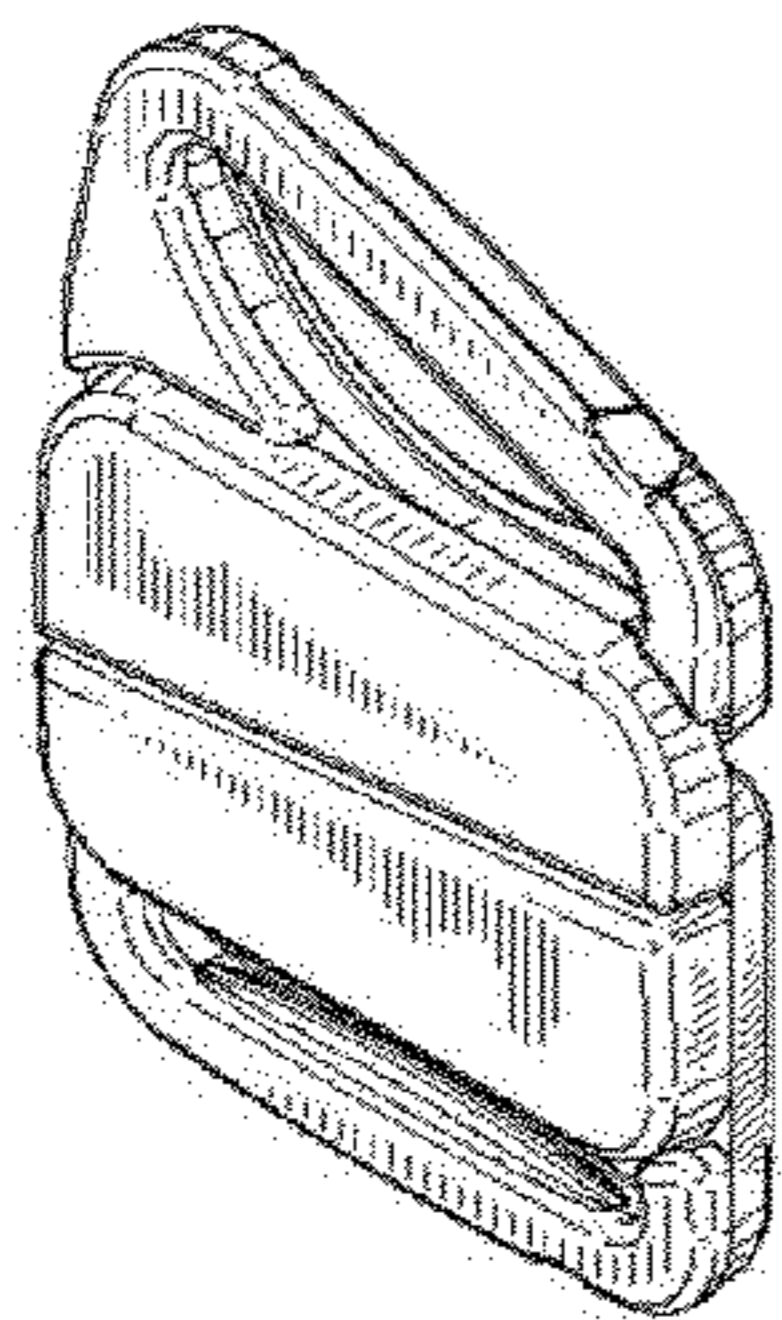

FIG. 16

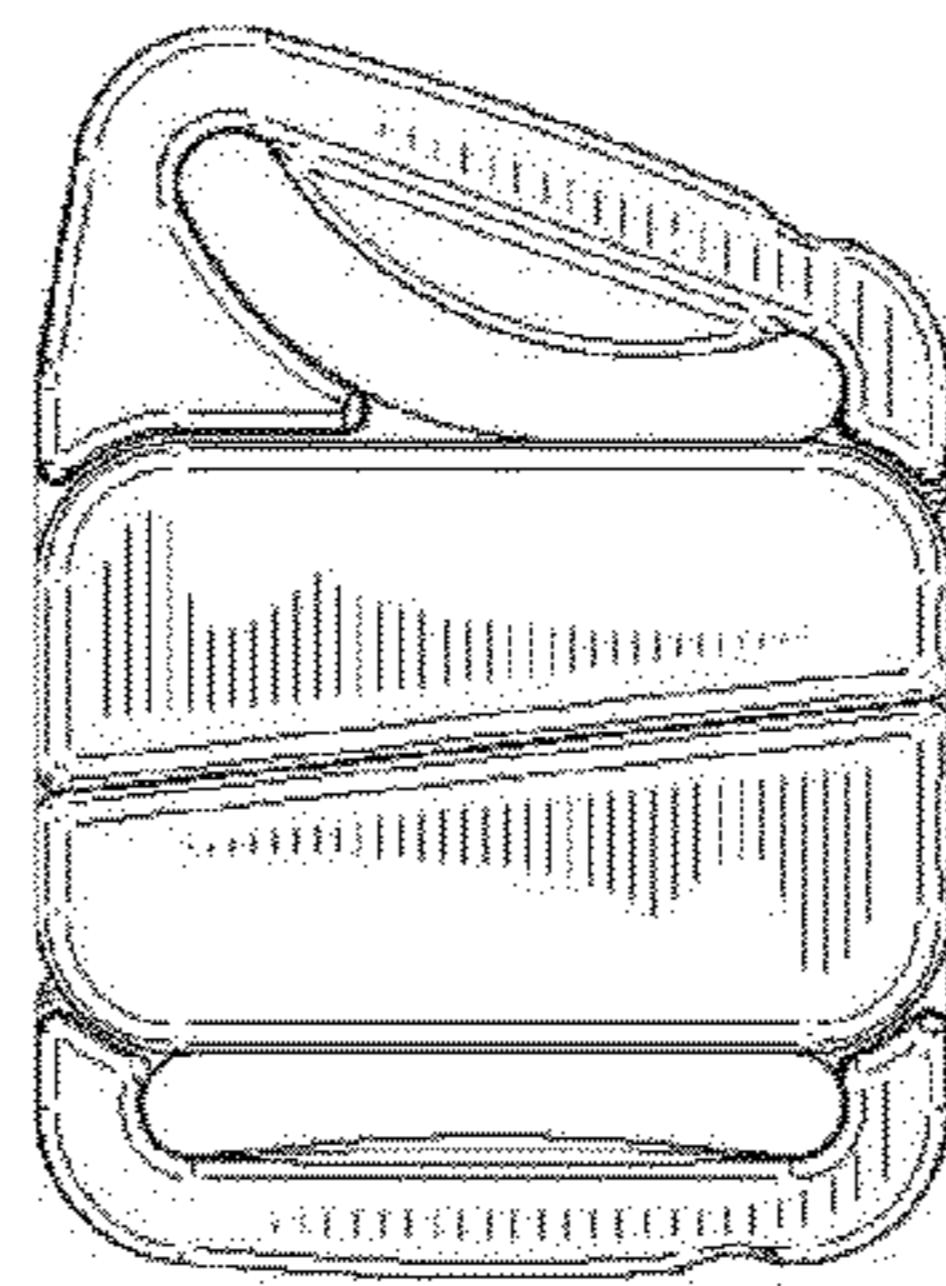

FIG. 17



FIG. 18

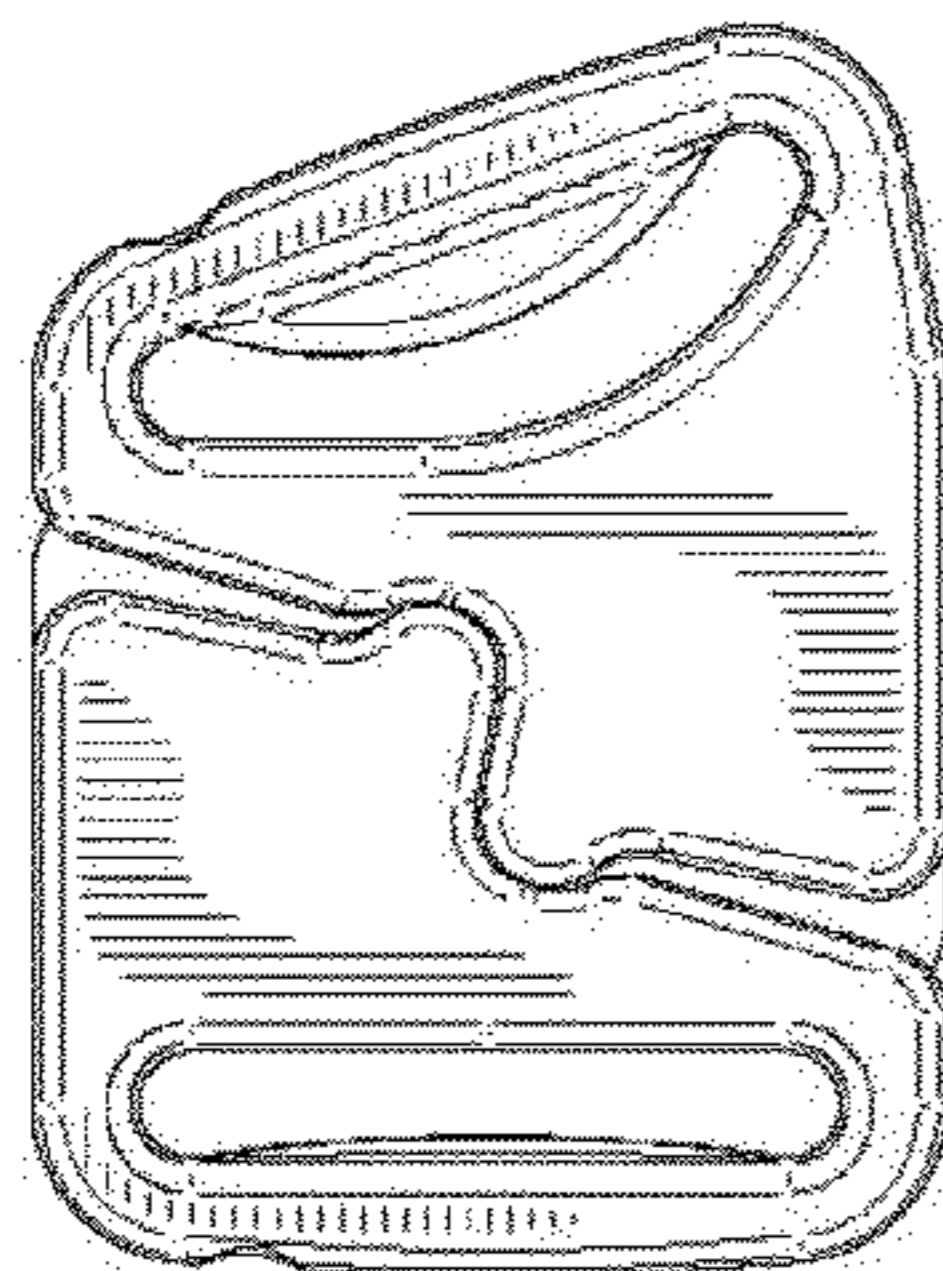

FIG. 19



FIG. 20

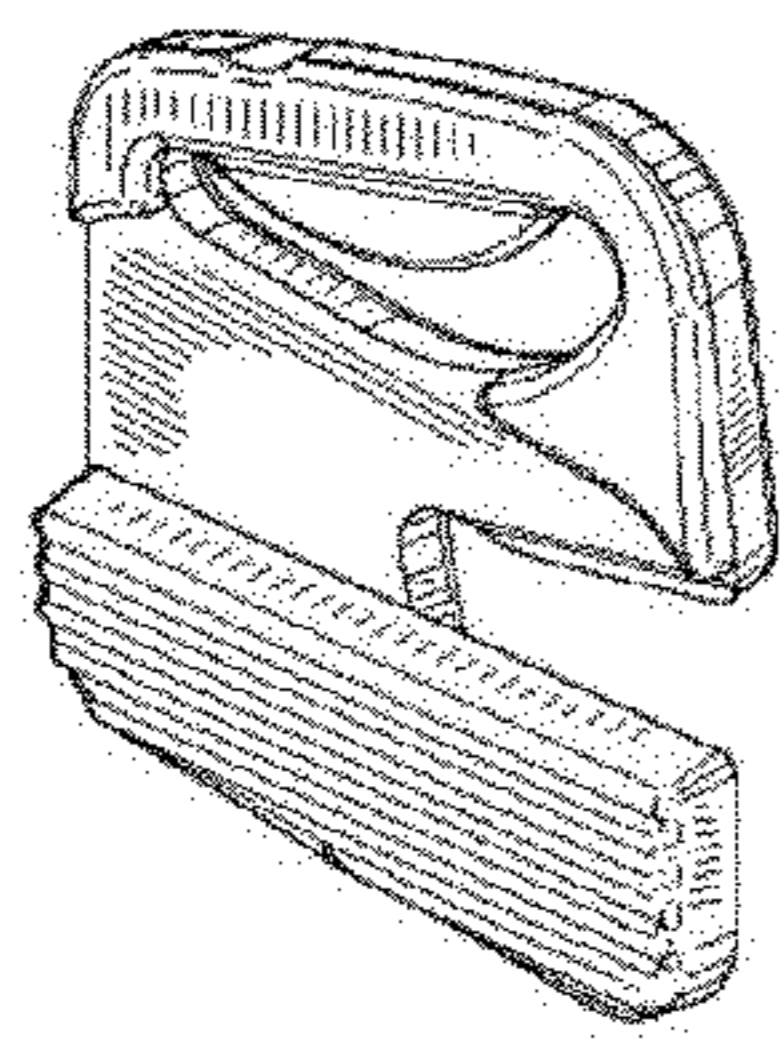

FIG. 21

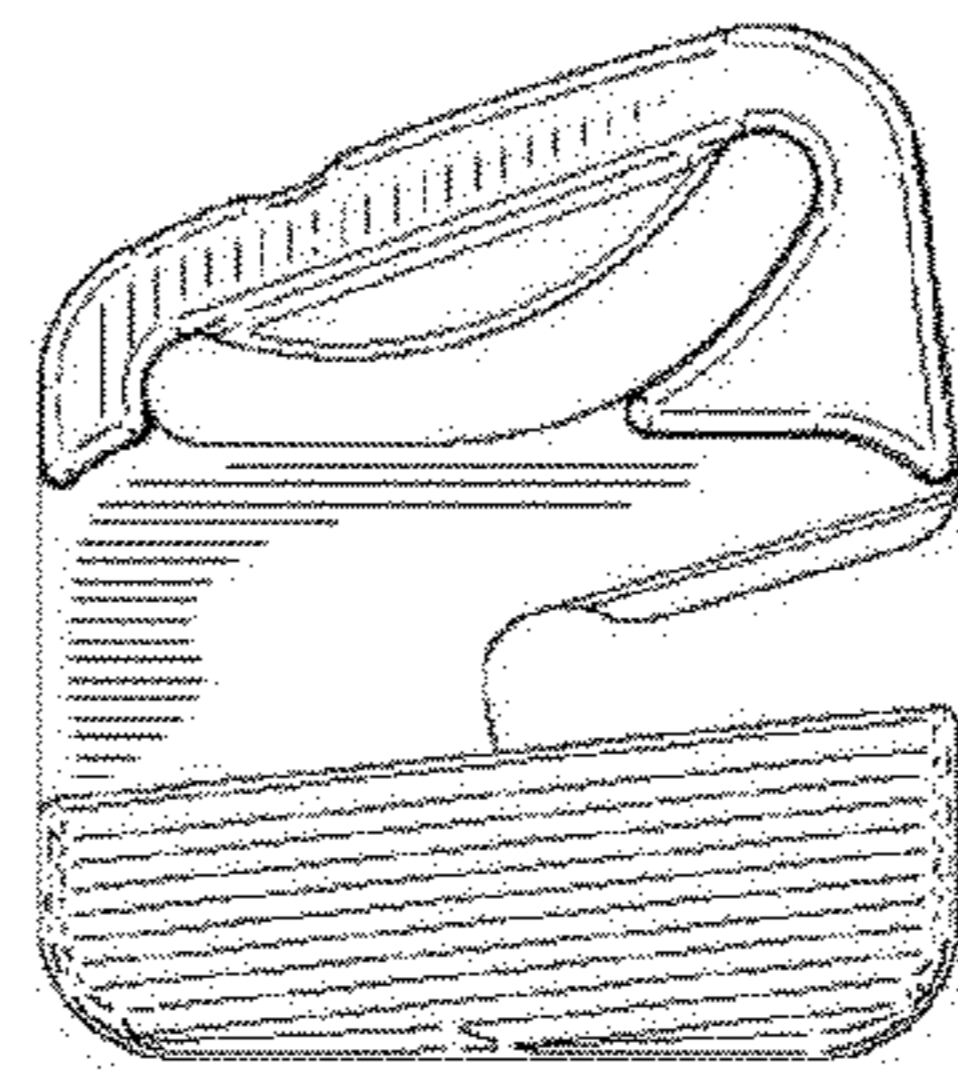

FIG. 22

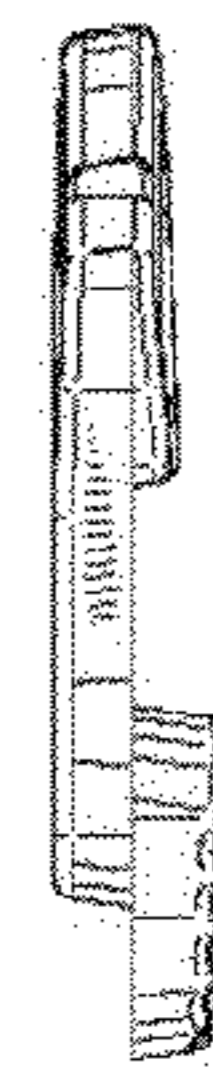

FIG. 23

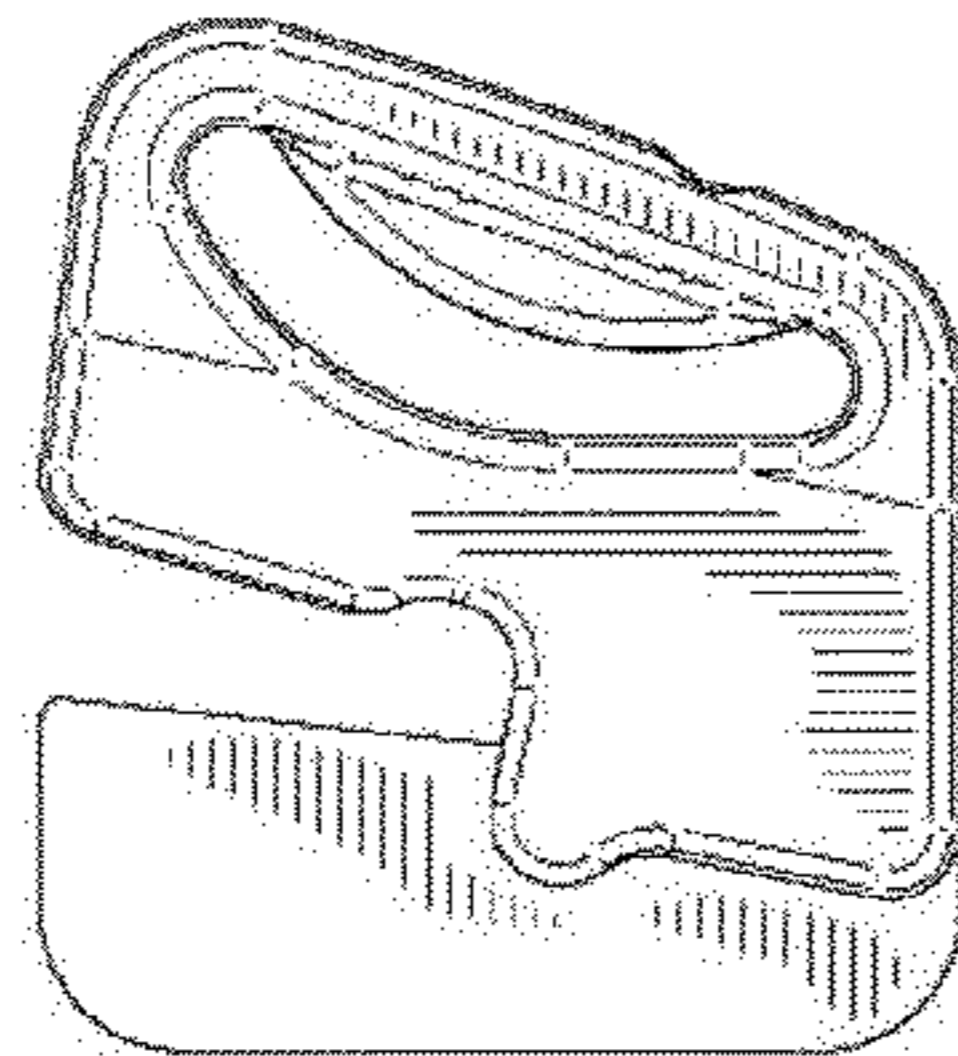

FIG. 24

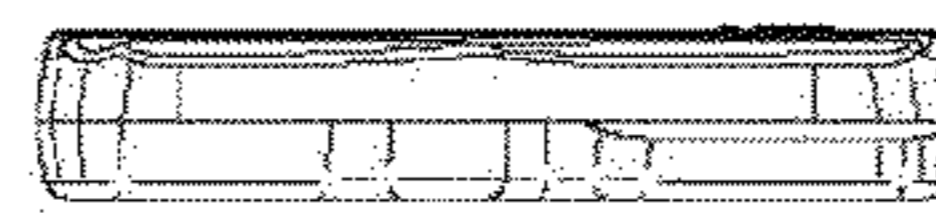

FIG. 25

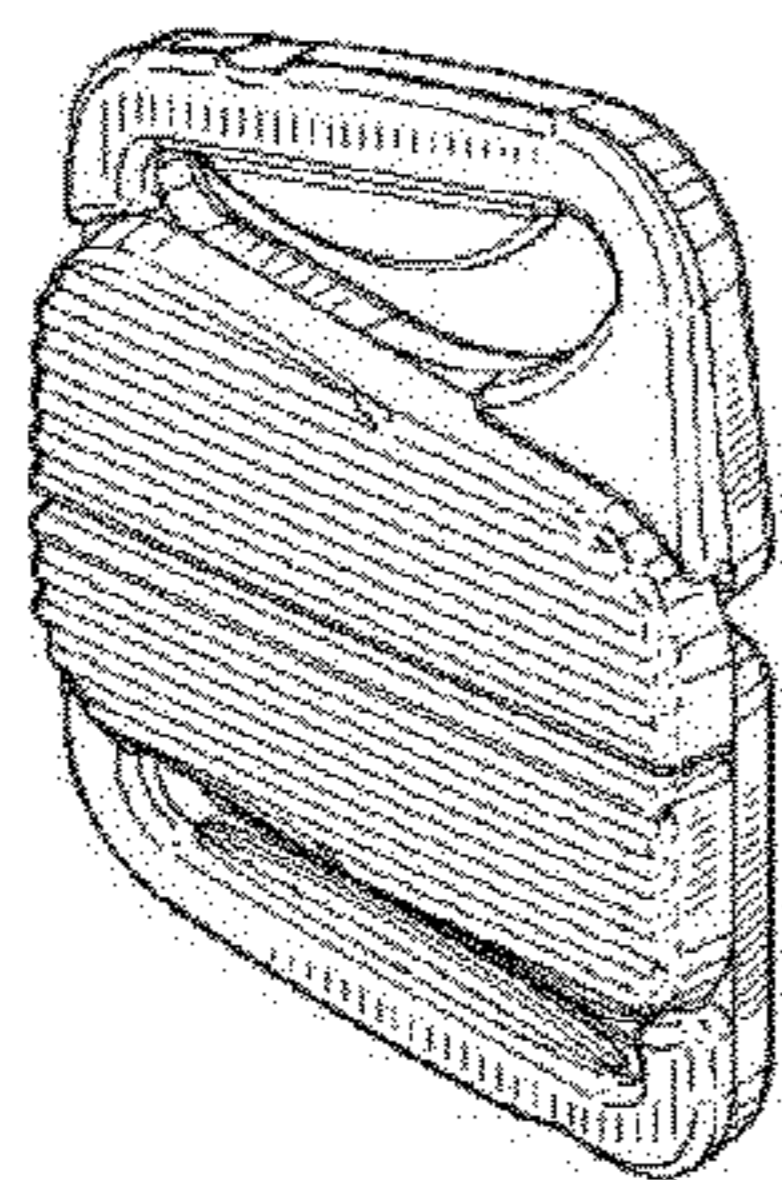

FIG. 26

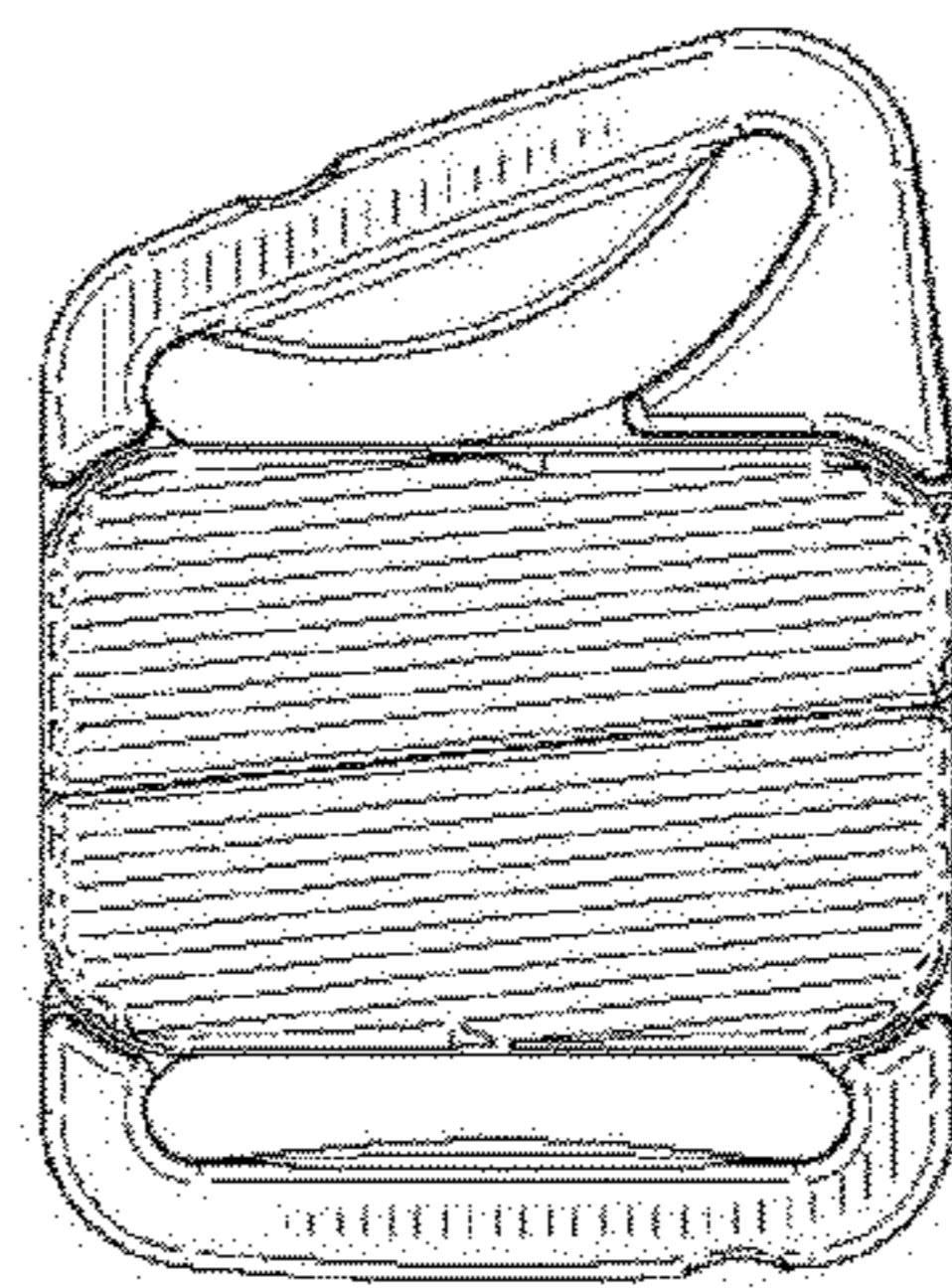

FIG. 27

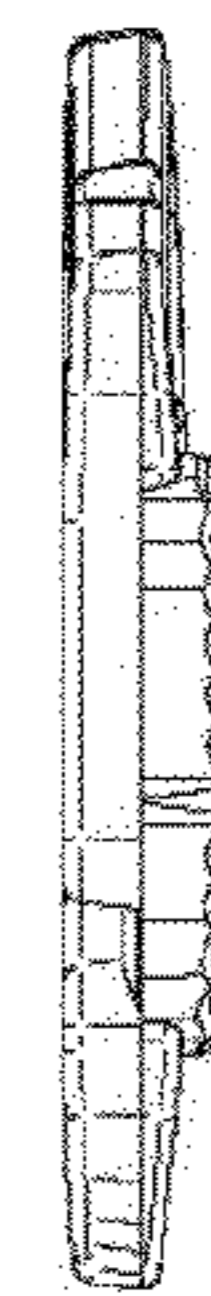

FIG. 28

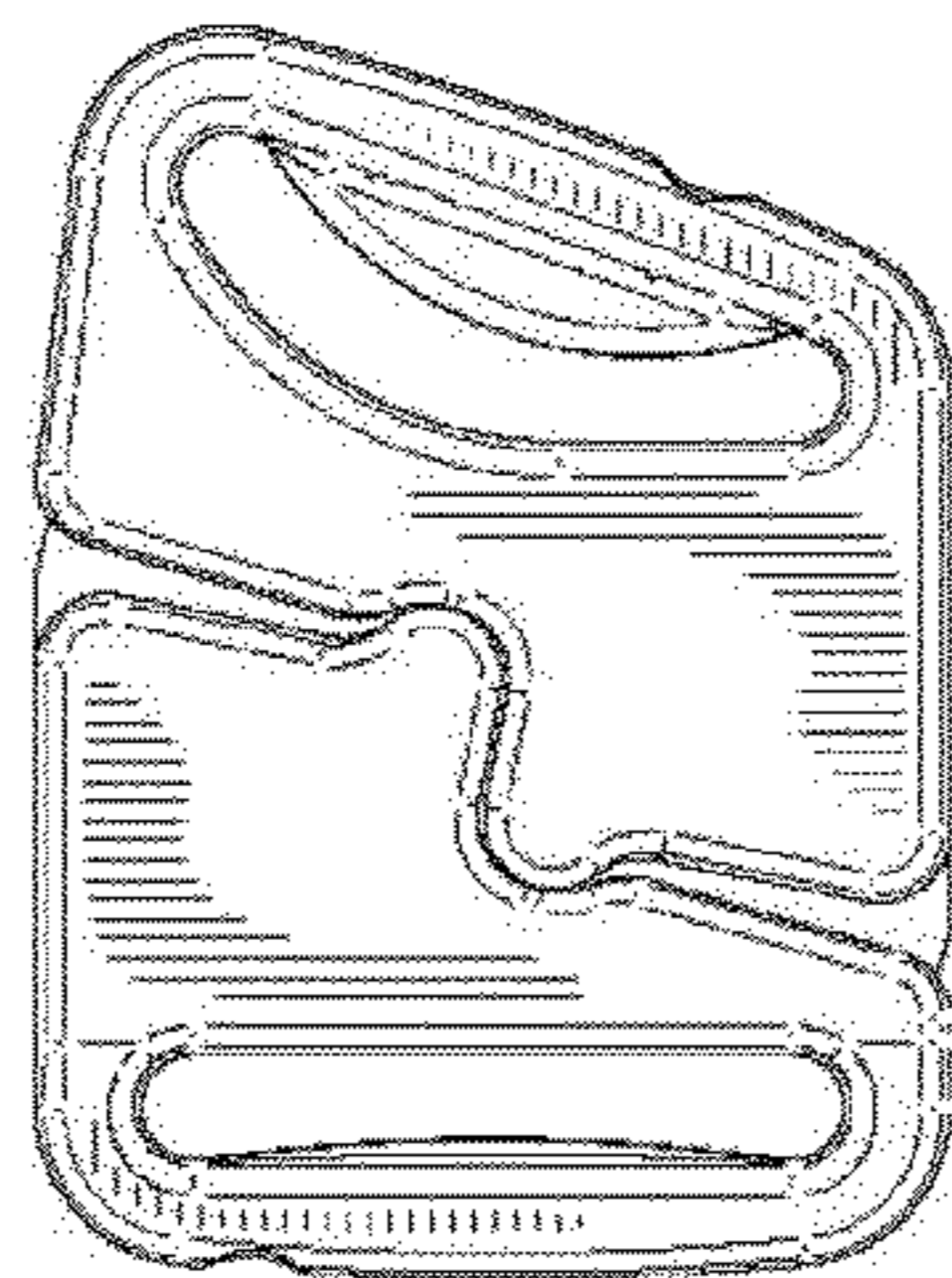

FIG. 29



FIG. 30

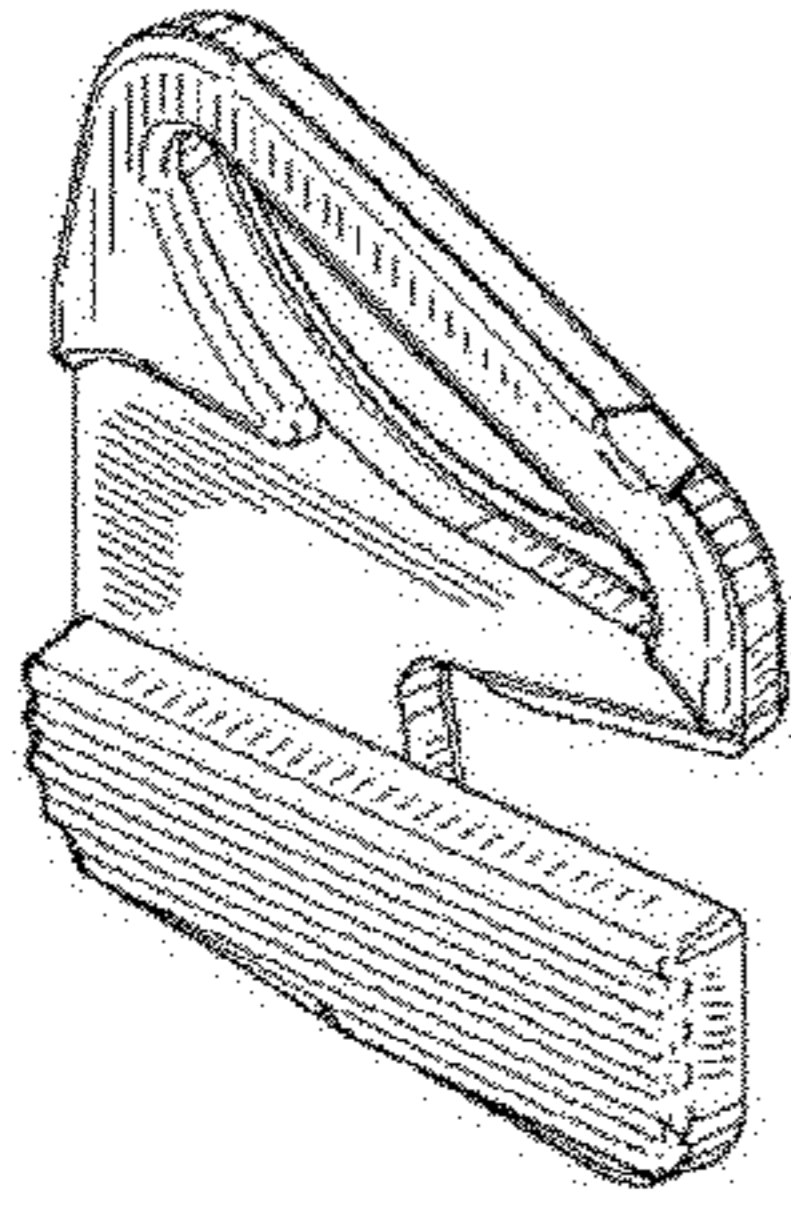

FIG. 31

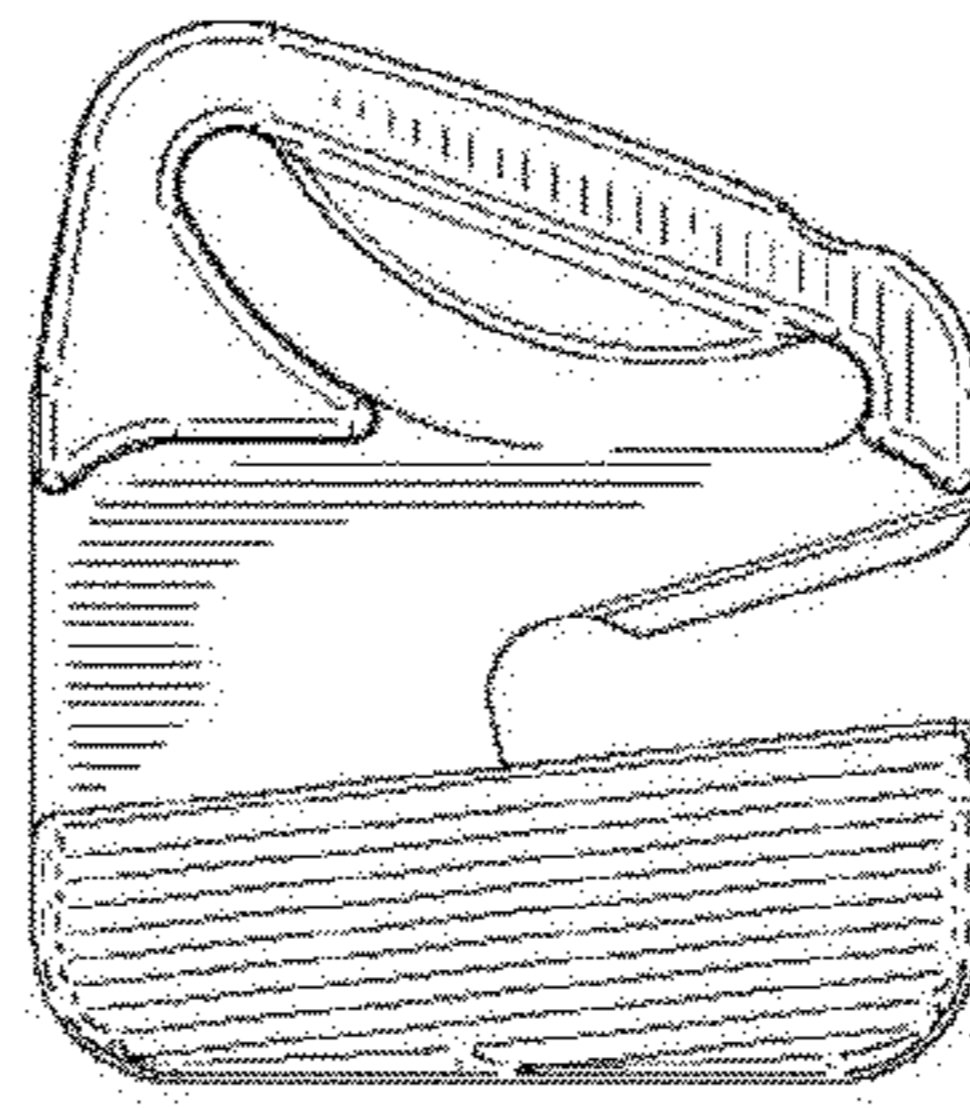

FIG. 32

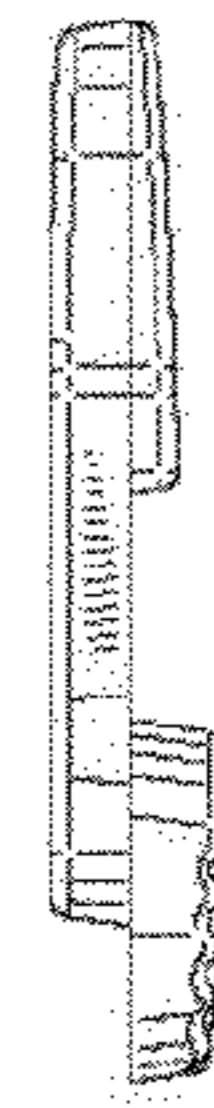

FIG. 33

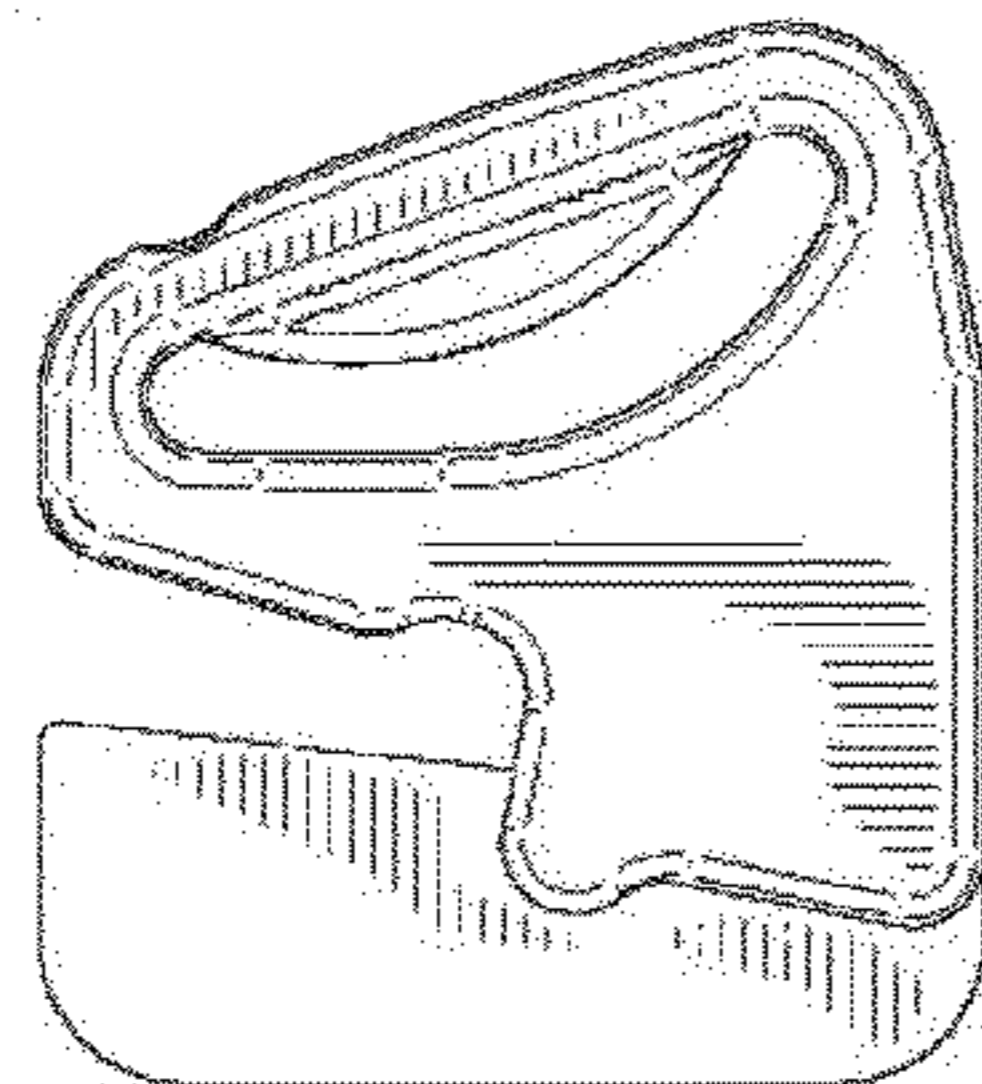

FIG. 34

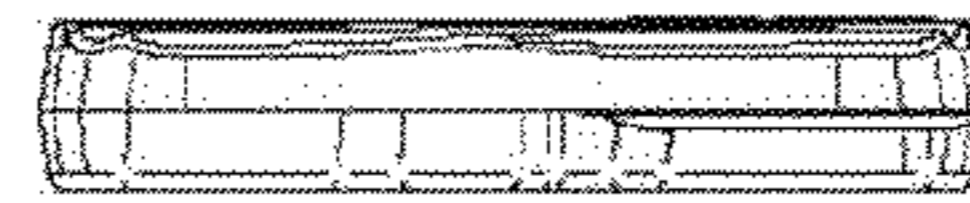

FIG. 35

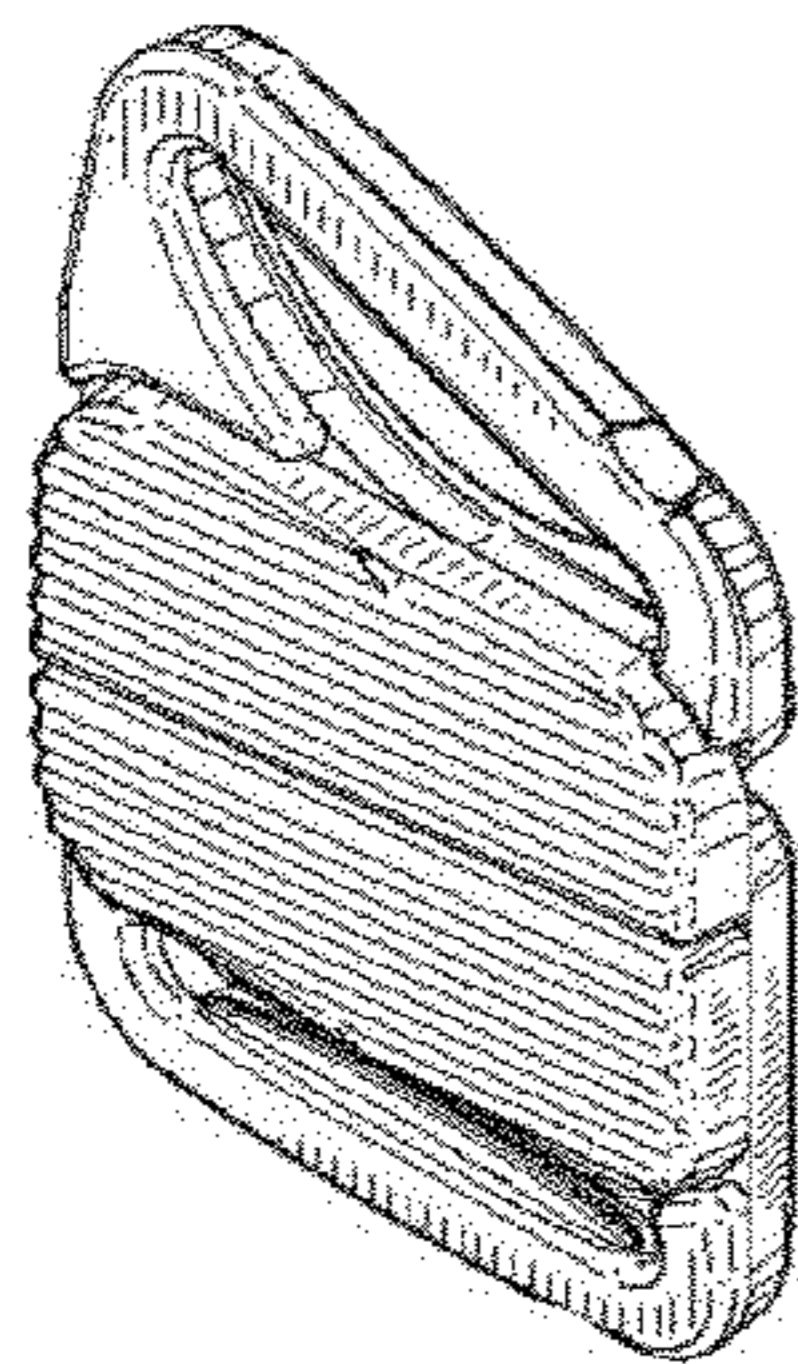

FIG. 36

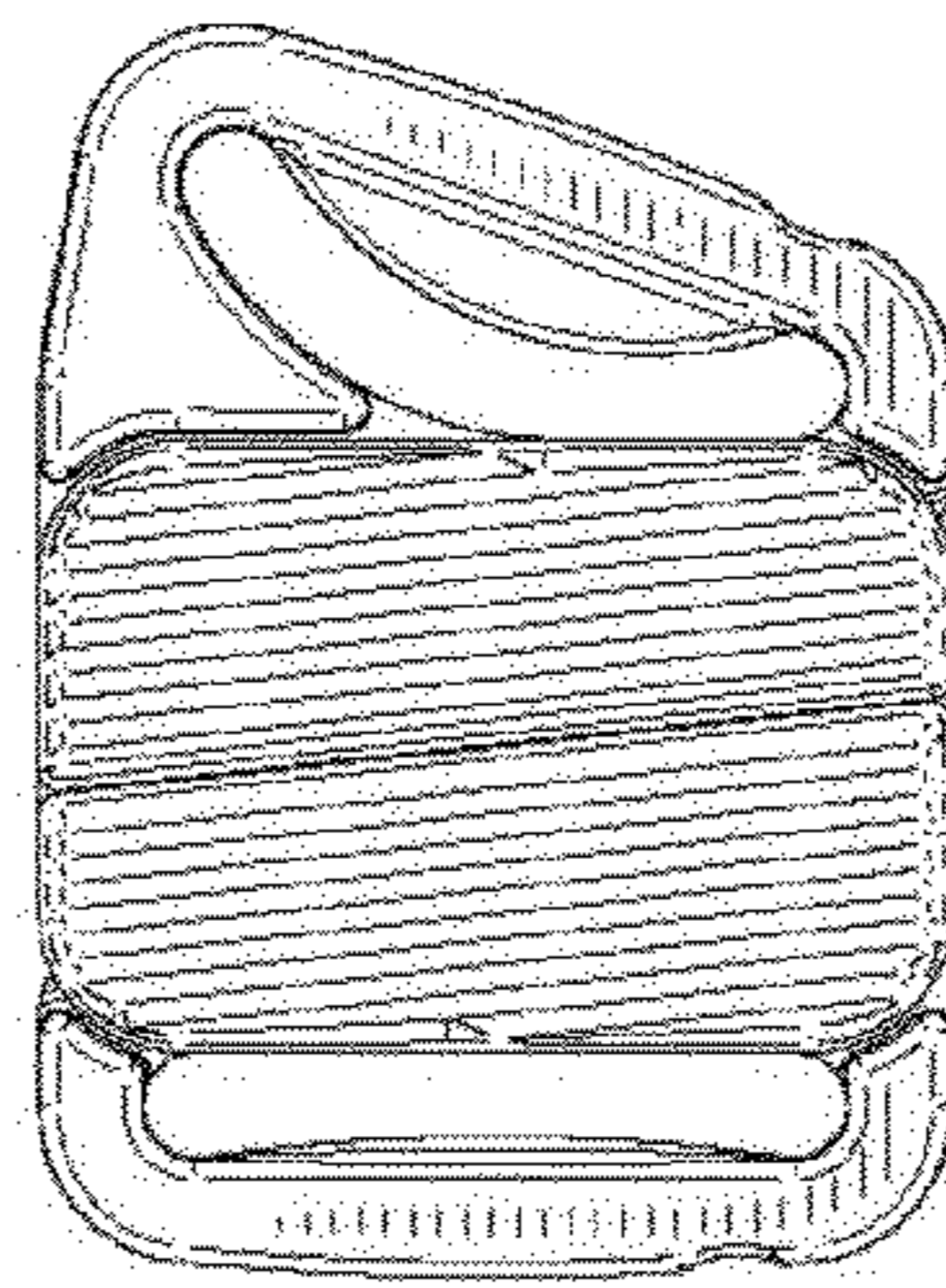

FIG. 37



FIG. 38

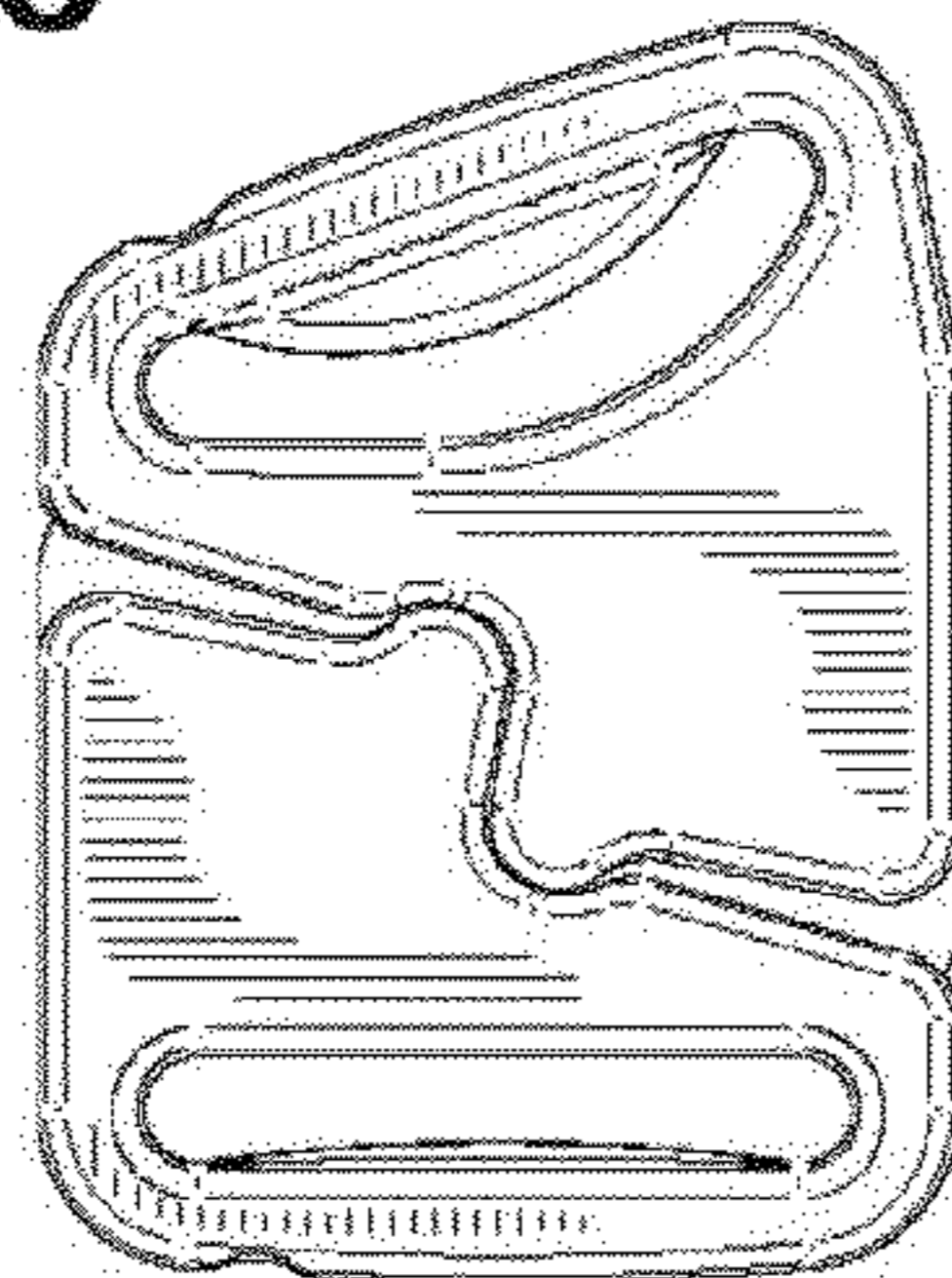

FIG. 39



FIG. 40