



US00D732390S

(12) **United States Design Patent**
Trombetta

(10) **Patent No.:** **US D732,390 S**

(45) **Date of Patent:** **** *Jun. 23, 2015**

- (54) **CAPSULE**
- (71) Applicant: **2266170 Ontario Inc.**, Mississauga, Ontario (CA)
- (72) Inventor: **Liberatore A. Trombetta**, Ancaster (CA)
- (73) Assignee: **2266170 Ontario Inc.** (CA)
- (*) Notice: This patent is subject to a terminal disclaimer.
- (**) Term: **14 Years**
- (21) Appl. No.: **29/464,395**
- (22) Filed: **Aug. 15, 2013**
- (51) **LOC (10) Cl.** **09-01**
- (52) **U.S. Cl.**
USPC **D9/500; D9/428**
- (58) **Field of Classification Search**
USPC D9/414, 416, 418, 419, 423, 424, 425, D9/428, 434, 438, 435, 440, 447, 454, 499, D9/442, 444, 500, 501, 502, 505, 503, 504, D9/535, 544, 696, 715, 716, 733, 777; D7/509, 510, 511, 532, 538, 554.2, D7/309, 601, 602, 619.1, 665, 415, 900; 229/906.1, 405; 220/359.2; 206/5, 216, 206/222, 217, 548, 528, 532, 530; D3/202; 426/77, 80, 115, 122
CPC B65D 85/8043; B65D 85/8046; B65D 2565/385; B65D 2575/583; B65D 25/08; B65D 47/283; B65D 53/02; B65D 75/5883; B65D 81/18; B65D 81/3227; B65D 85/70
See application file for complete search history.

4,215,797 A *	8/1980	Chen	220/359.4
D259,625 S	6/1981	Hamilton et al.	
D263,447 S	3/1982	Brown	
D312,400 S	11/1990	Schwaikert	
D321,477 S	11/1991	Gunter	
D334,113 S	3/1993	Lewis et al.	
D400,397 S *	11/1998	Stephan	D7/510
6,237,777 B1	5/2001	Bierly	
D445,674 S	7/2001	Pritchett	
D452,433 S	12/2001	Lazaris	
D452,434 S	12/2001	Sweeney	
D473,788 S	4/2003	Chen et al.	
D474,110 S	5/2003	Sweeney	
D474,111 S	5/2003	Lazaris	
D501,368 S	2/2005	Roth et al.	
D502,362 S	3/2005	Lazaris et al.	
D536,579 S	2/2007	Roth et al.	
D559,623 S *	1/2008	Schellenberg	D7/511
D568,156 S	5/2008	Wilson et al.	
D572,133 S	7/2008	Wilson et al.	
D577,253 S	9/2008	Bodum	
D577,288 S	9/2008	Wilson et al.	
D608,499 S *	1/2010	Hodgson et al.	D27/190
D635,399 S *	4/2011	DelVecchio	D7/523
D637,484 S	5/2011	Winkler	
D642,454 S	8/2011	Santoiemmo	
D642,455 S	8/2011	Santoiemmo	
D646,968 S	10/2011	Ortiz et al.	
D647,398 S	10/2011	Winkler	
D647,399 S	10/2011	Winkler	
D652,266 S *	1/2012	Smyers	D7/630
D656,009 S	3/2012	Ortiz et al.	
D656,010 S	3/2012	Ortiz et al.	
D658,493 S *	5/2012	Cometto	D9/424
D671,831 S	12/2012	Moreau	
D675,091 S *	1/2013	Cook et al.	D9/428
D685,263 S *	7/2013	Danenberg	D9/428
D686,496 S *	7/2013	Strauli	D9/439
D689,768 S *	9/2013	Inderbitzin	D9/429
D695,110 S *	12/2013	Houlton et al.	D9/428
D695,111 S *	12/2013	Hansen et al.	D9/429
D697,797 S *	1/2014	Hansen	D9/429
D699,566 S *	2/2014	De Pra	D9/425
D703,035 S *	4/2014	Zanetti	D9/416
D703,039 S *	4/2014	Hansen	D9/429
D716,648 S *	11/2014	Tan	D9/416
2011/0183048 A1 *	7/2011	Noble et al.	426/122
2013/0105340 A1 *	5/2013	Hother et al.	206/222
2013/0136828 A1 *	5/2013	Anghileri	426/112
2014/0161936 A1 *	6/2014	Trombetta et al.	426/77
2014/0161937 A1 *	6/2014	Rondelli	426/80

(56) **References Cited**
U.S. PATENT DOCUMENTS

D4,260 S	7/1870	Doyle	
2,919,844 A	1/1960	Anderson	
D244,063 S	4/1977	Christian	
D247,548 S	3/1978	Crary	
4,213,539 A *	7/1980	Reuter	220/819

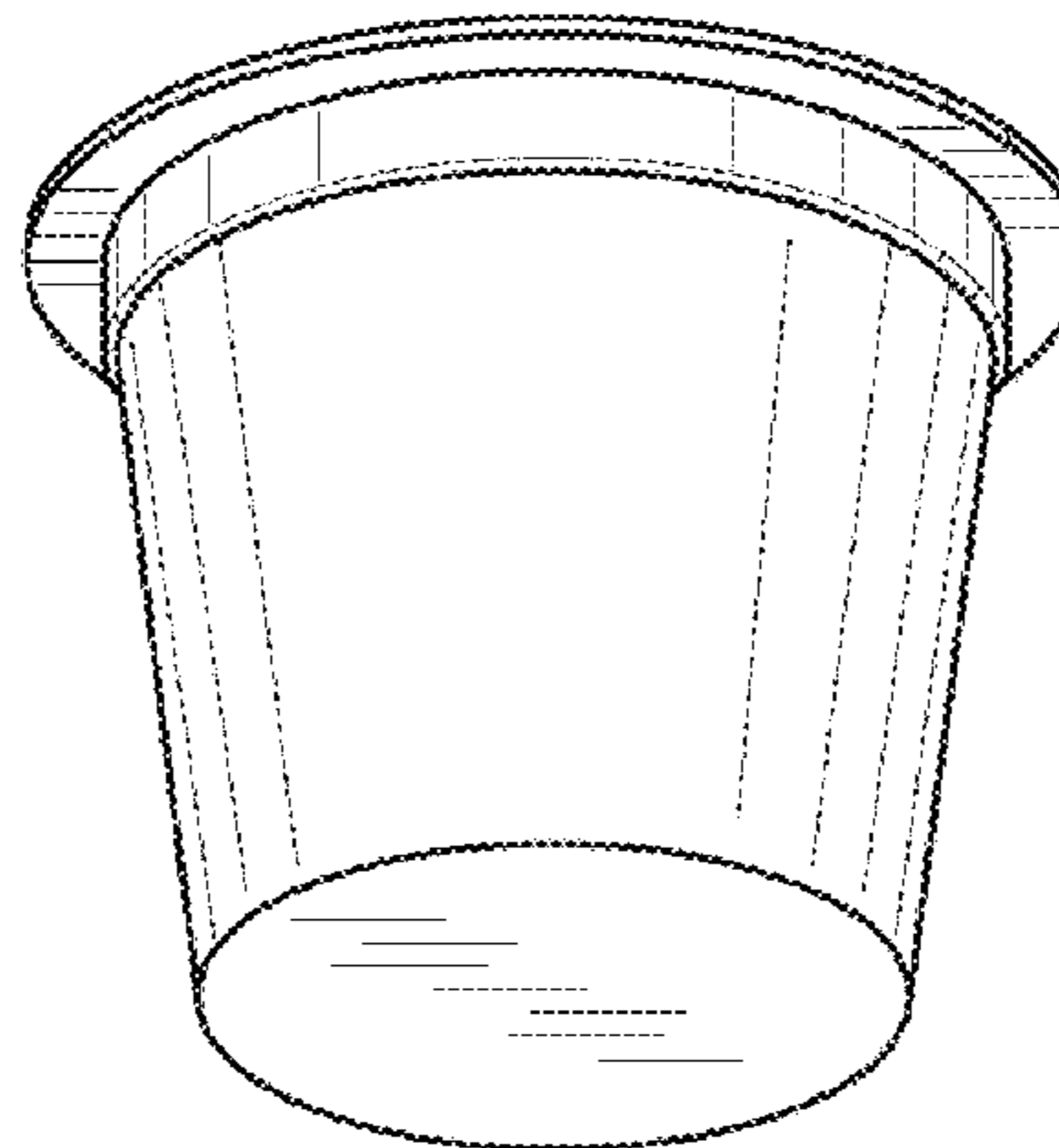
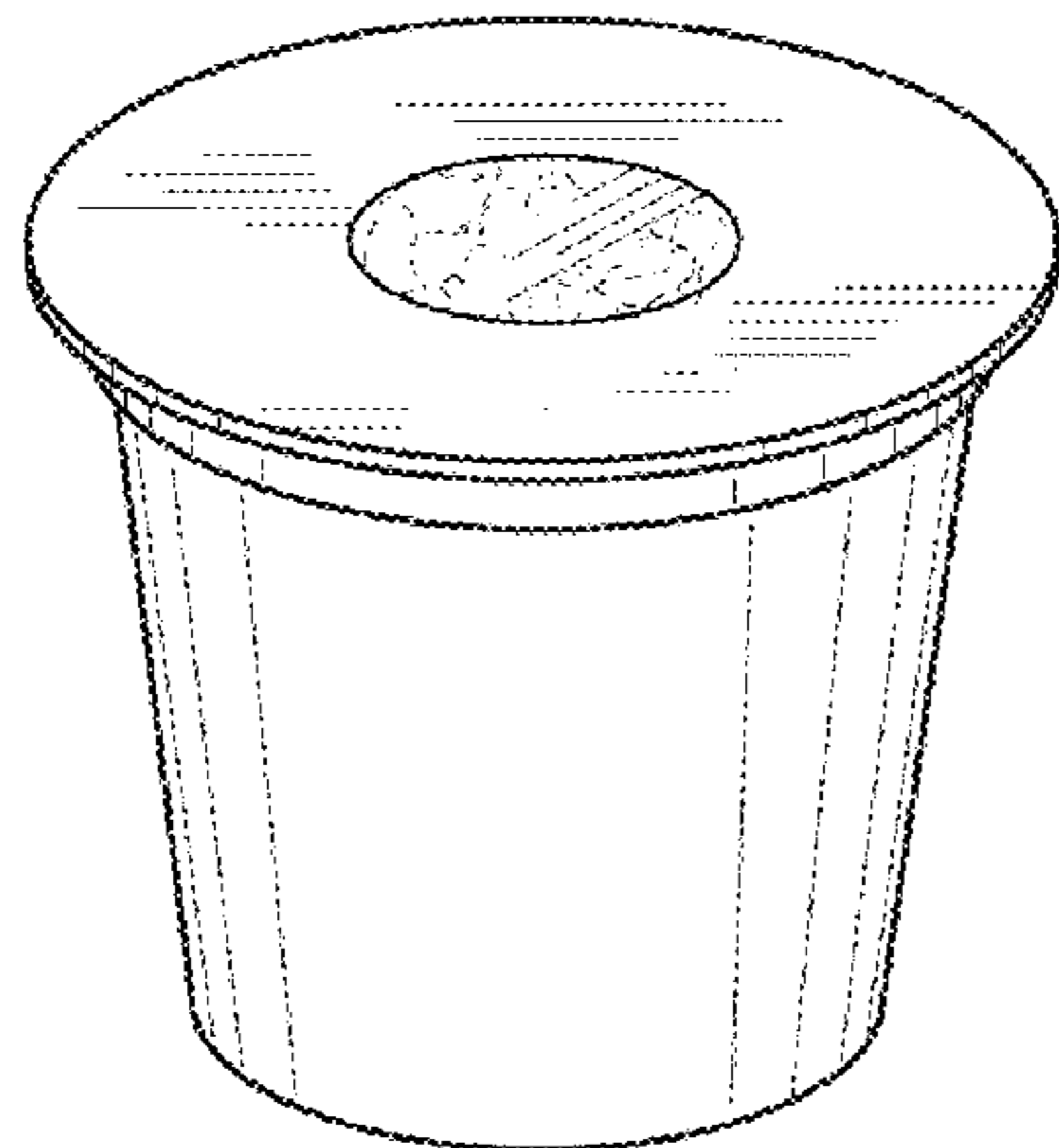

2014/0234494 A1* 8/2014 Doglioni Majer 426/115
 2014/0377413 A1* 12/2014 Liu 426/115
 2015/0001100 A1* 1/2015 Bartoli et al. 206/5

FOREIGN PATENT DOCUMENTS

CN	3102737	2/1999	
CN	3102740	2/1999	
CN	3102741	2/1999	
CN	3103590	2/1999	
CN	3336639	11/2003	
CN	3336640	11/2003	
CN	3336646	11/2003	
CN	3340286	12/2003	
CN	3386161	8/2004	
CN	3429241	3/2005	
CN	3442199	4/2005	
CN	3442205	4/2005	
CN	3448912	5/2005	
CN	3448913	5/2005	
CN	3469773	8/2005	
CN	300707939	11/2007	
CN	300707940	11/2007	
CN	300707941	11/2007	
CN	300707942	11/2007	
CN	300710086	11/2007	
CN	300710087	11/2007	
CN	300710088	11/2007	
CN	300710089	11/2007	
CN	300815220	8/2008	
CN	300833940	10/2008	
CN	300843246	10/2008	
CN	301347136	9/2010	
CN	301437314	1/2011	
CN	301505145	4/2011	
CN	302041529	8/2012	
CN	302141646	10/2012	
CN	302141791	10/2012	
CN	302297349	1/2013	
CN	302370417	3/2013	
CN	302439912	5/2013	
EP	1243210	A1* 9/2002 A47J 31/40
EP	2394932	A1* 12/2011	
EP	2520202	A1* 11/2012	
FR	2973209	A1* 10/2012	
WO	WO 2008071878	A2* 6/2008	

OTHER PUBLICATIONS

Internet search URL<<http://evewaspartiallyright.blogspot.com/2011/03/product-review-safeway-brand-greek.html> [Date searched Mar. 3, 2015].*

Internet search URL<<http://retaildesignblog.net/2012/07/04/artease-cafe-identity-by-splash-productions/> [Date searched Mar. 3, 2015].*

Internet search URL<<http://depositphotos.com/10060401/stock-photo-k-cup-coffee-pods.html?sst=0&sqc=1&sqm=4&sq=36soav> [Date searched Mar. 3, 2015].*

Internet search URL<<http://www.soap.com/p/caribou-coffee-k-cup-coffee-mahogany-24-ct-155082> [Date searched Mar. 3, 2015].*

Internet search URL<<http://www.greenpackaging365.com/greenblog/?=bioplastics> [Date searched Mar. 3, 2015].*

U.S. Appl. No. 29/464,387, titled “Capsule,” filed Aug. 15, 2013.

U.S. Appl. No. 29/464,380, titled “Capsule,” filed Aug. 15, 2013.
 U.S. Appl. No. 29/464,384, titled “Capsule,” filed Aug. 15, 2013.
 U.S. Appl. No. 29/464,393, titled “Capsule,” filed Aug. 15, 2013.
 U.S. Appl. No. 29/464,399, titled “Capsule,” filed Aug. 15, 2013.
 U.S. Appl. No. 29/464,397, titled “Capsule,” filed Aug. 15, 2013.
 U.S. Appl. No. 29/485,747, titled “Capsule,” filed Mar. 21, 2014.
 U.S. Appl. No. 29/485,783, titled “Capsule,” filed Mar. 21, 2014.
 U.S. Appl. No. 29/485,784, titled “Capsule and/or Logo,” filed Mar. 21, 2014.

* cited by examiner

Primary Examiner — Thomas Johannes
Assistant Examiner — Keith Frank
 (74) *Attorney, Agent, or Firm* — Saidman DesignLaw Group, LLC

(57) **CLAIM**
 The ornamental design for a capsule, as shown and described.

DESCRIPTION

FIG. 1 is a top perspective view of a capsule showing my new design;
 FIG. 2 is a bottom perspective view thereof;
 FIG. 3 is a front view thereof, the rear, left and right side views being identical;
 FIG. 4 is a top view thereof;
 FIG. 5 is a bottom view thereof;
 FIG. 6 is another top view thereof, showing the word “TEXT” in broken lines.
 FIG. 7 is a top view of a second embodiment thereof, the bottom perspective, front, rear, left and right side and bottom views being identical to those of the first embodiment;
 FIG. 8 is another top view thereof, showing the word “TEXT” in broken lines.
 FIG. 9 is a top view of a third embodiment thereof, the bottom perspective, front, rear, left and right side and bottom views being identical to those of the first embodiment;
 FIG. 10 is another top view thereof, showing the word “TEXT” in broken lines.
 FIG. 11 is a top view of a fourth embodiment thereof, the bottom perspective, front, rear, left and right side and bottom views being identical to those of the first embodiment; and,
 FIG. 12 is another top view thereof, showing the word “TEXT” in broken lines.
 It is understood that the drawings include relatively thin surface shading lines that represent contour, not surface ornamentation. The diagonal parallel lines shading lines represent a transparent surface. The horizontal parallel shading lines represent an opaque surface. The broken lines illustrate unclaimed environment or features which form no part of the claimed design.

1 Claim, 12 Drawing Sheets

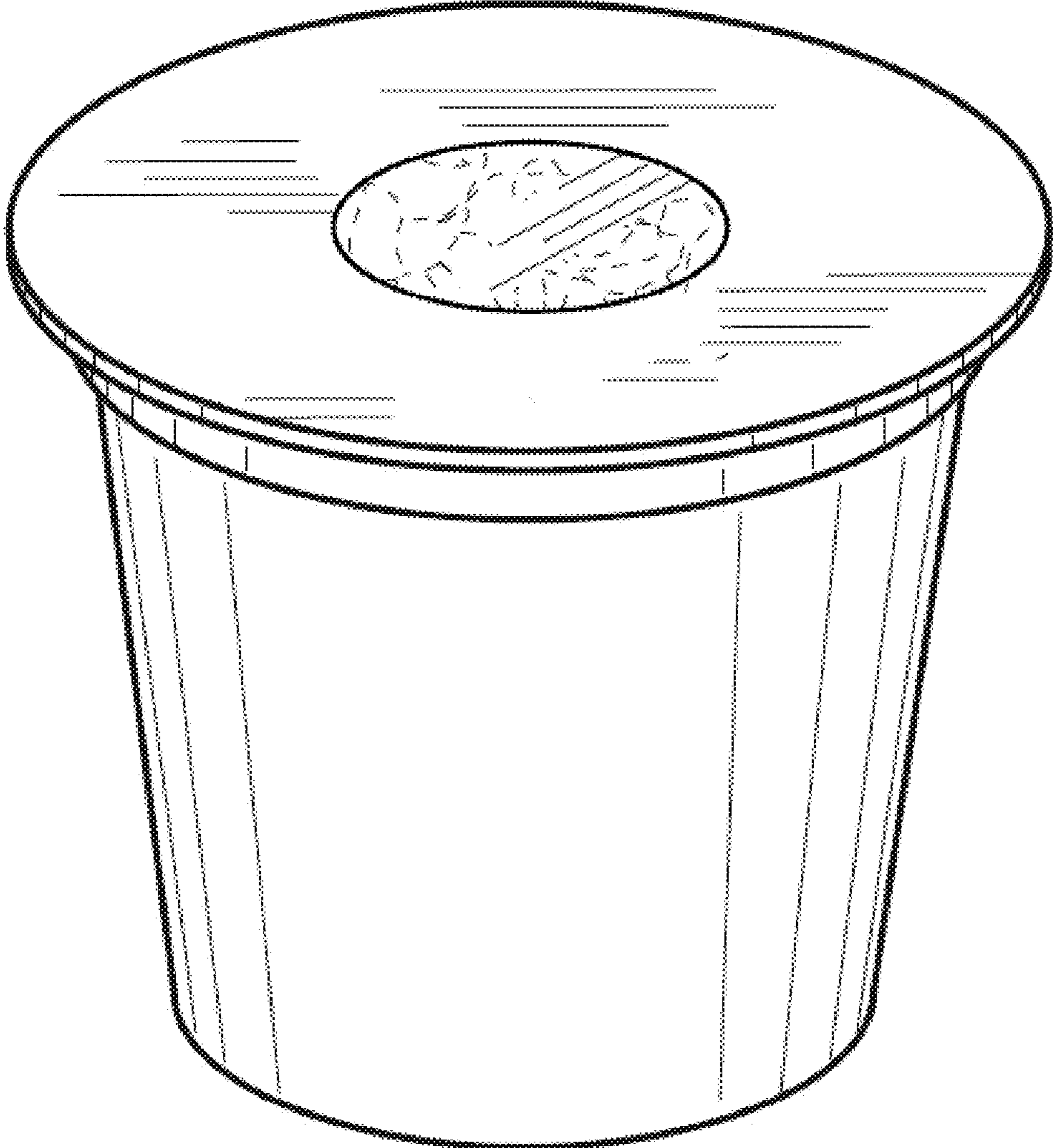

FIG. 1

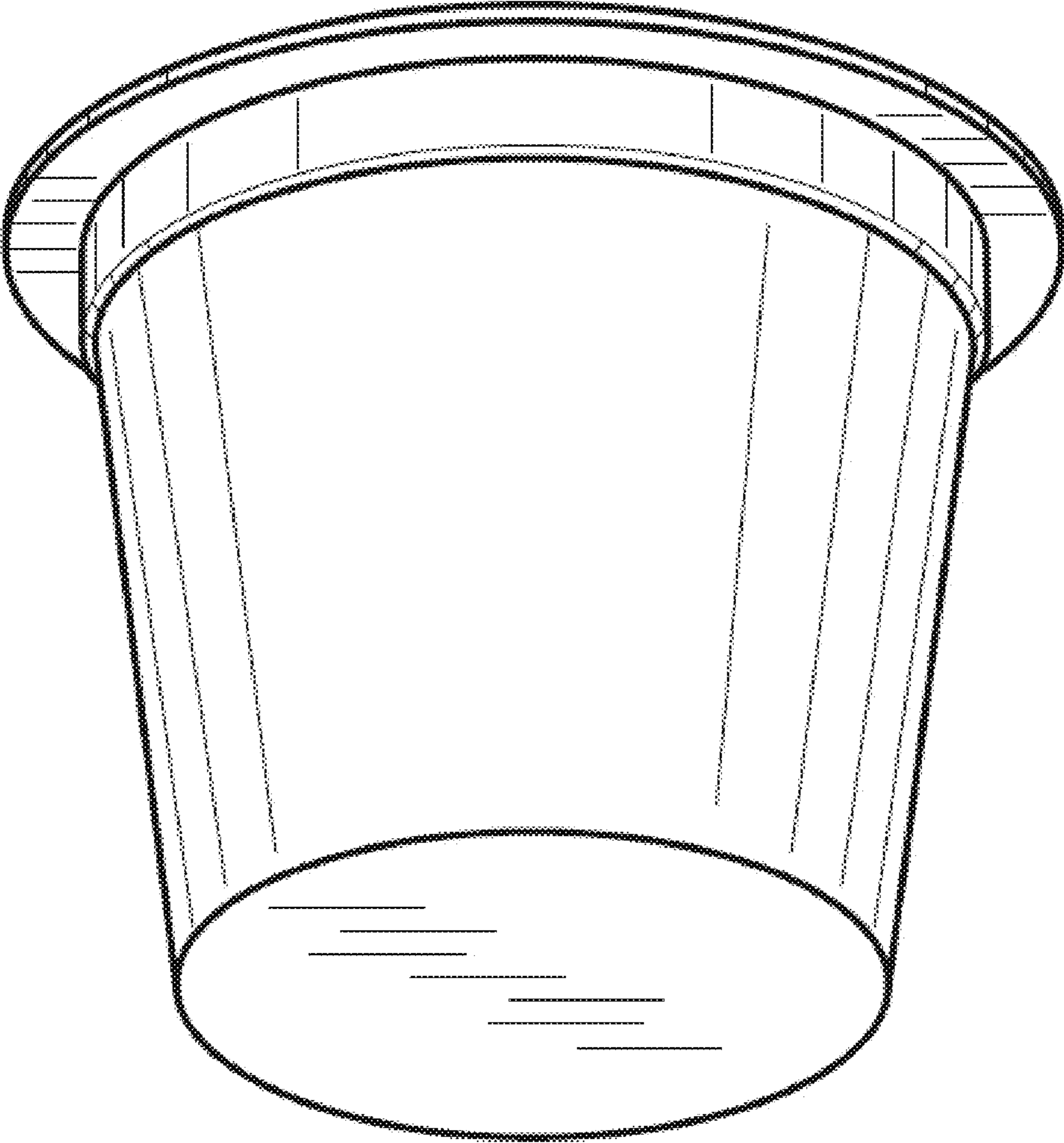

FIG. 2

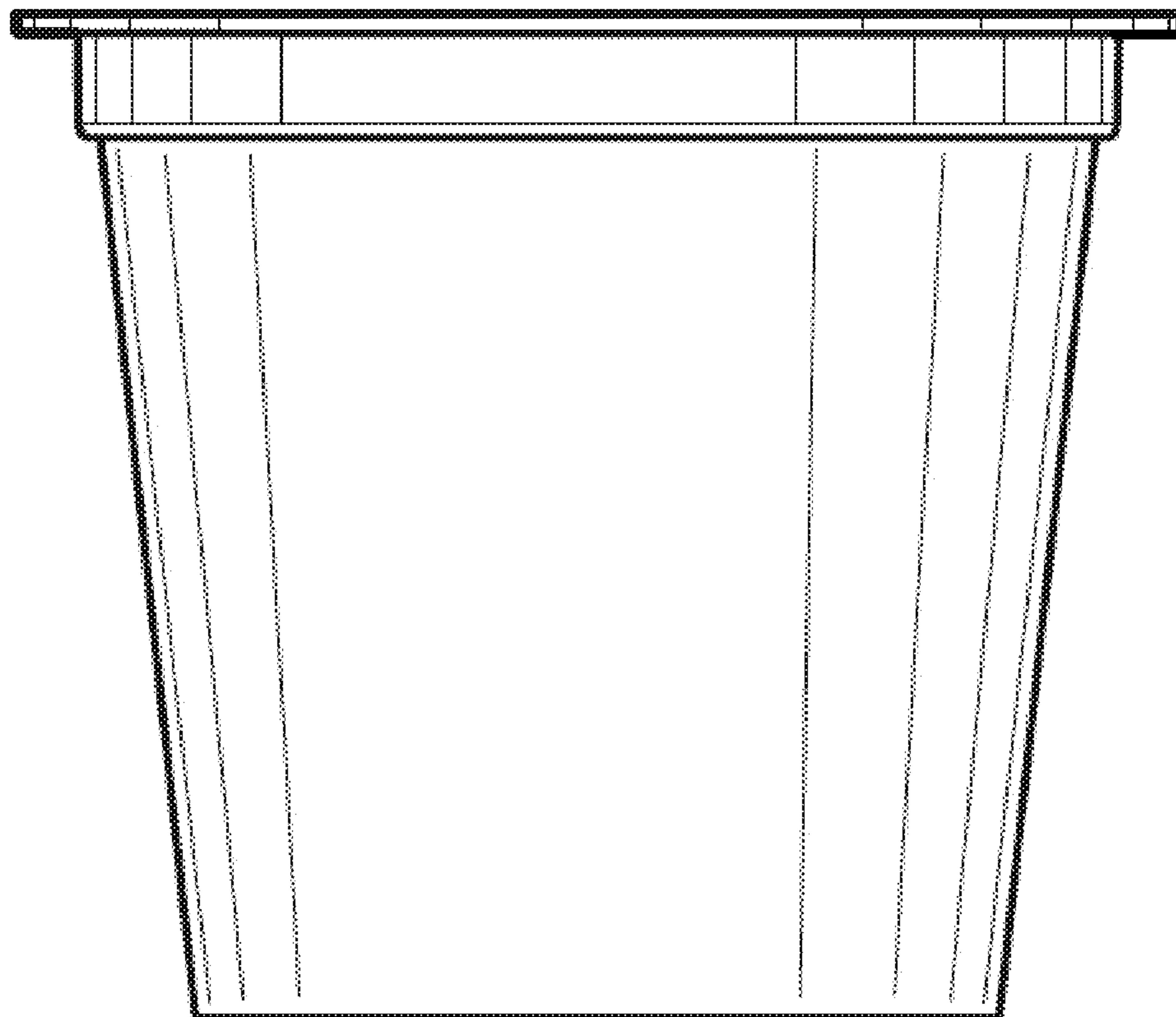

FIG. 3

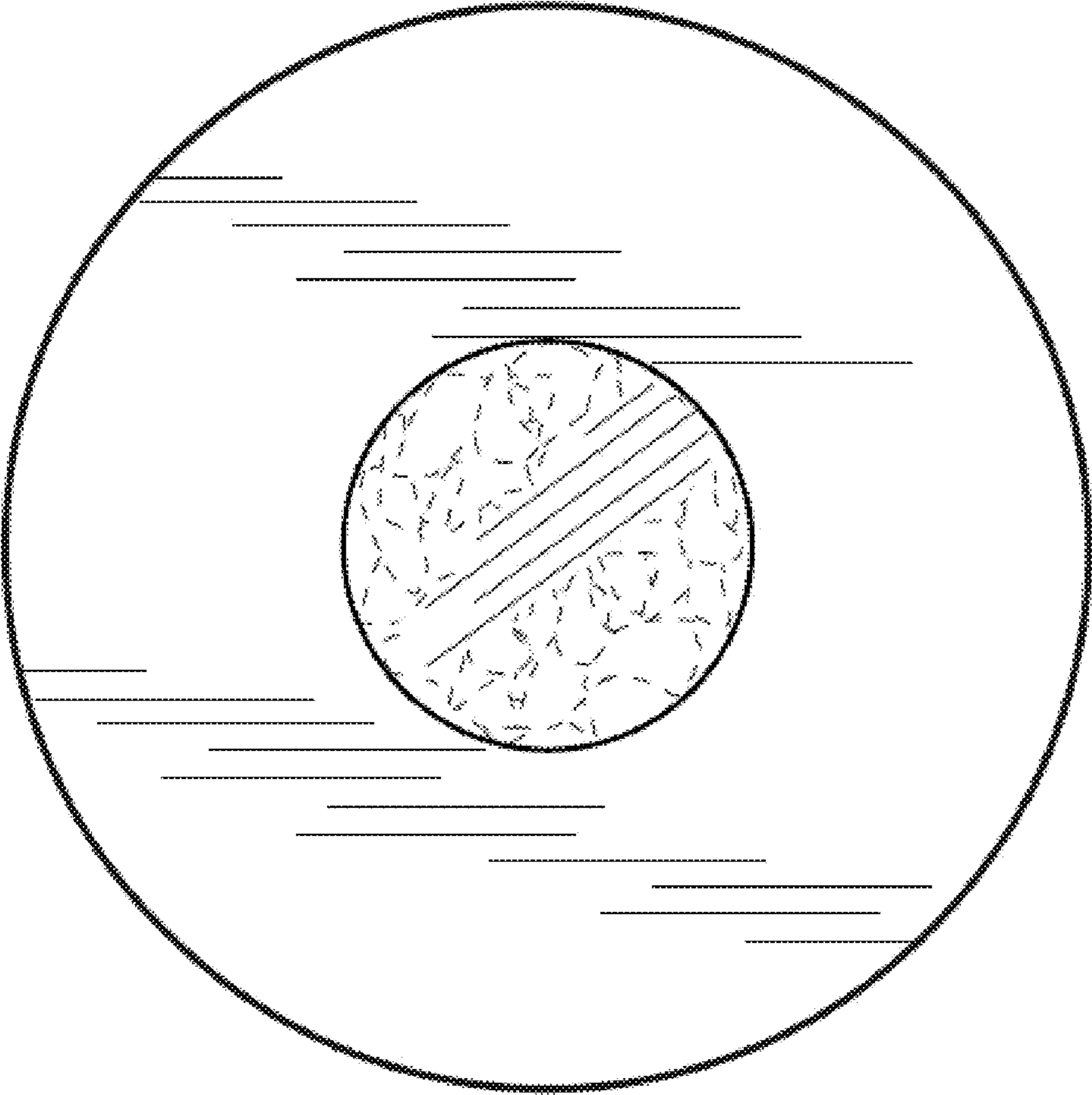

FIG. 4

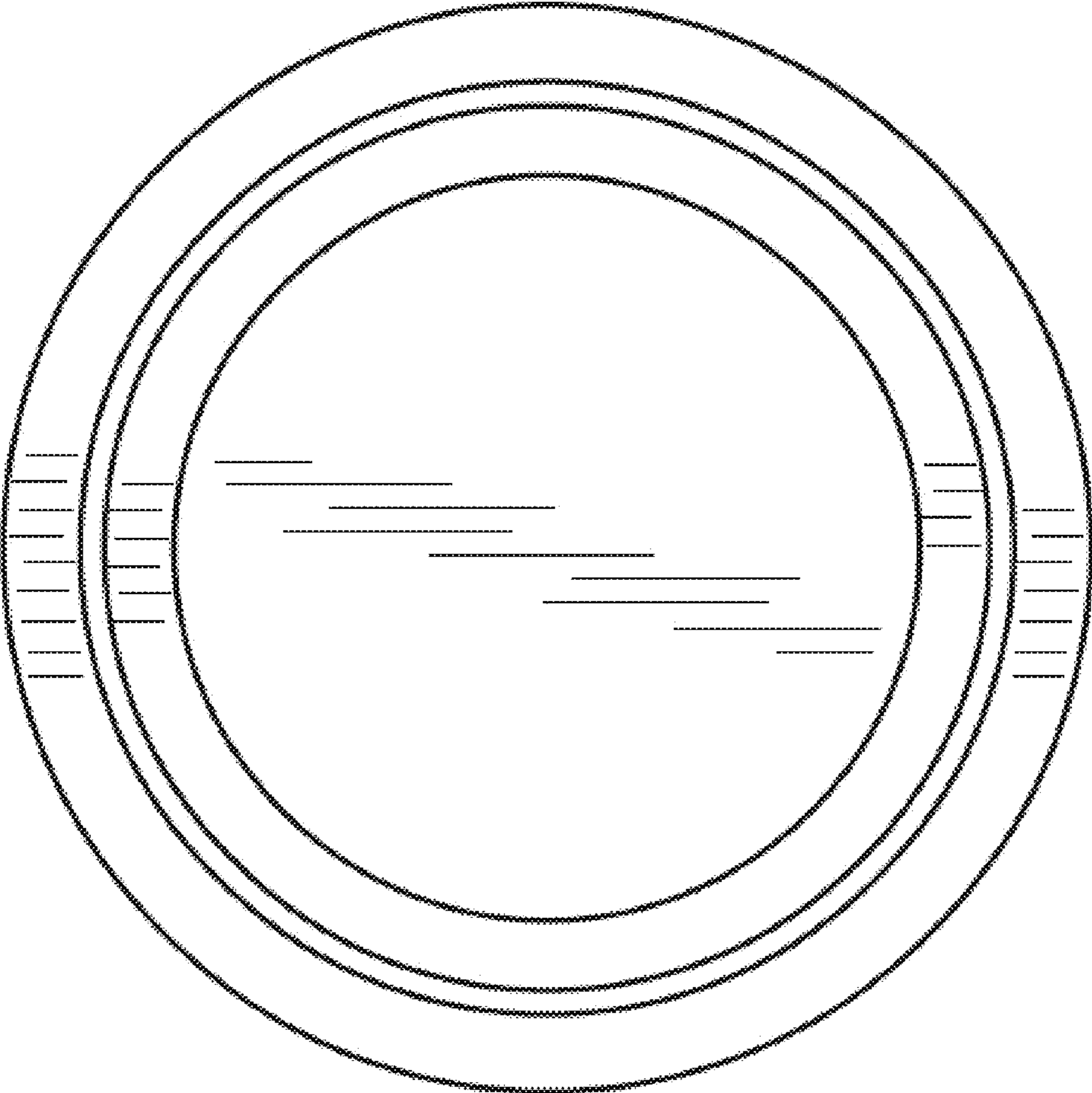

FIG. 5

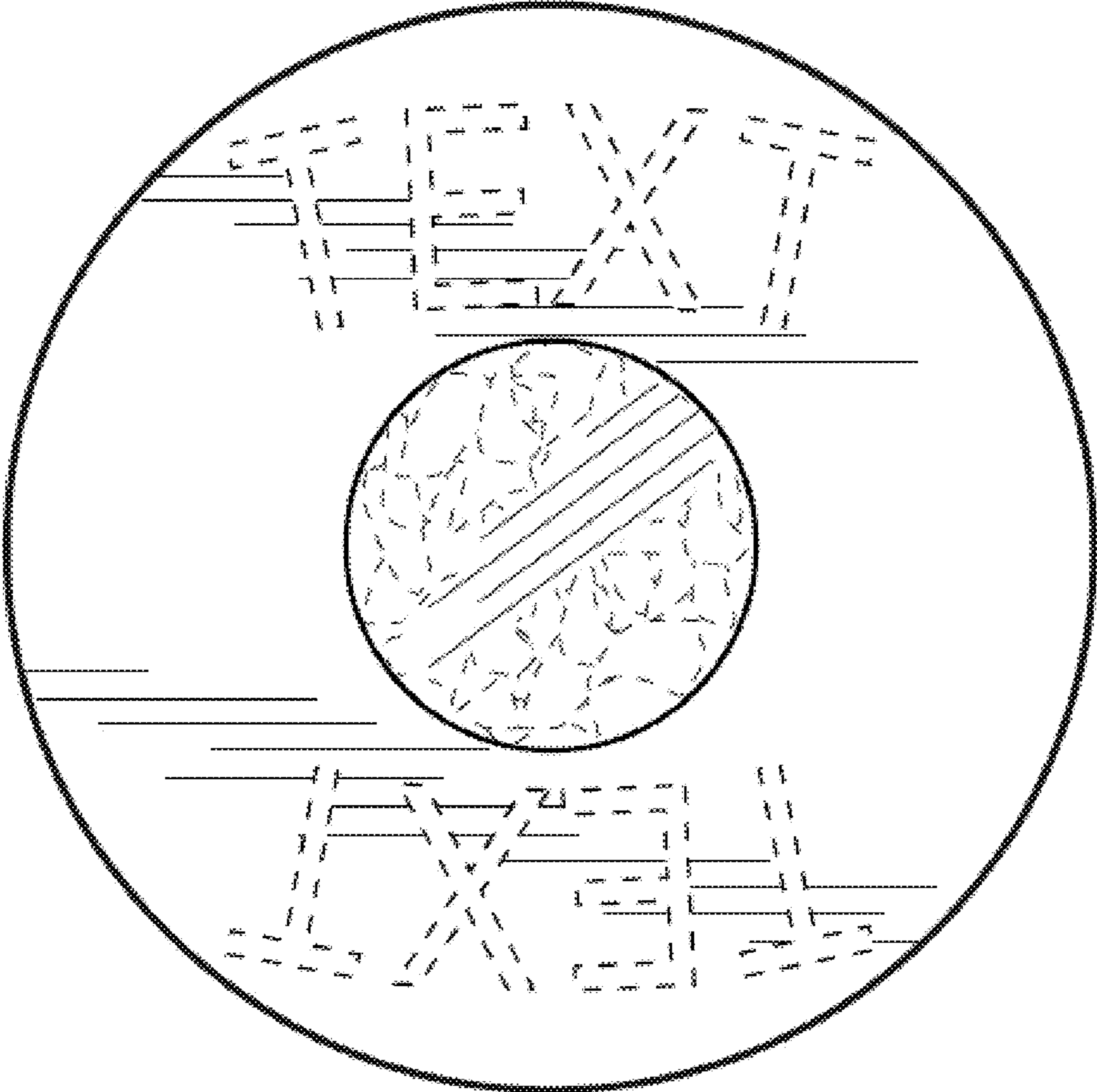

FIG. 6

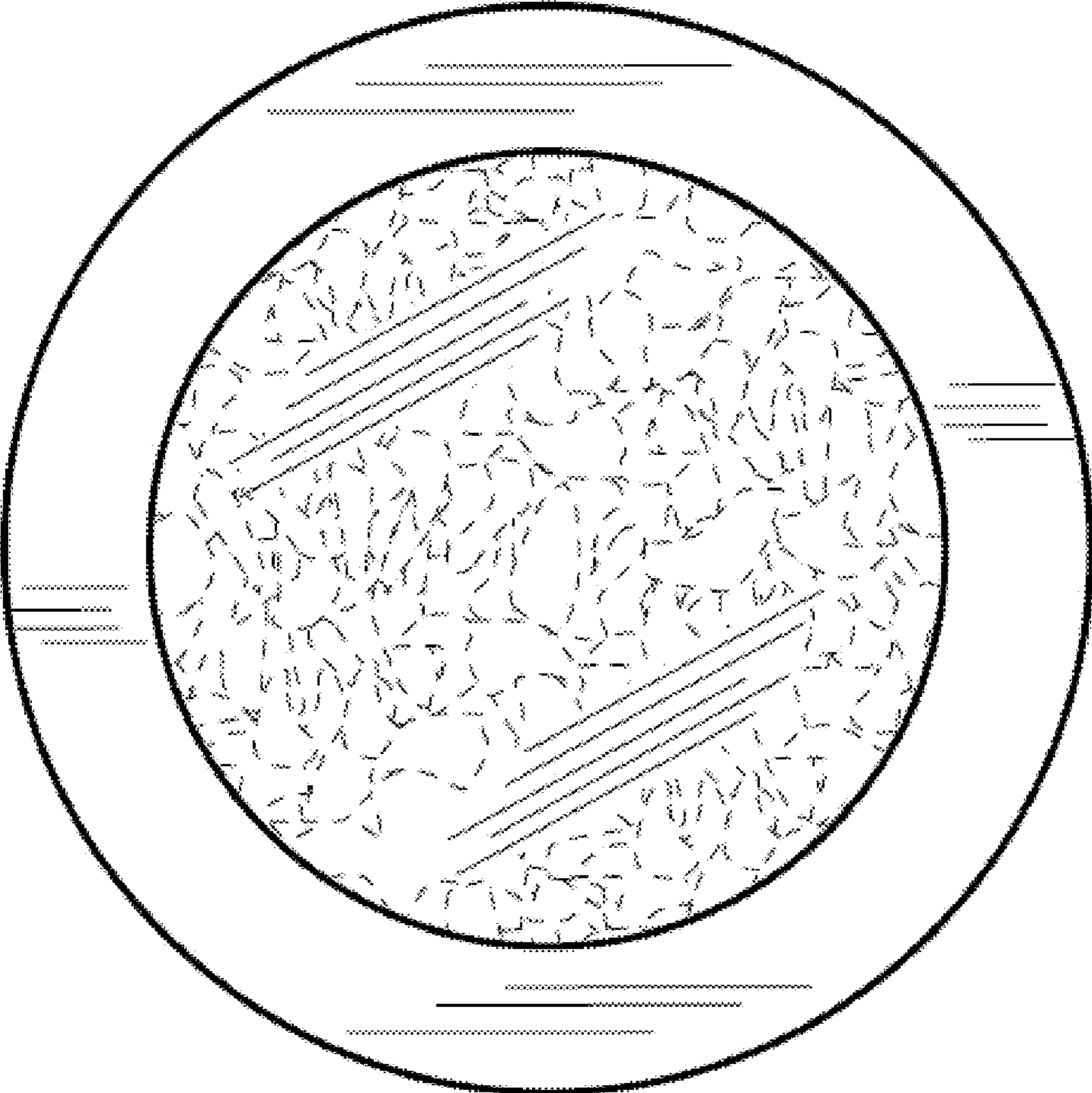

FIG. 7

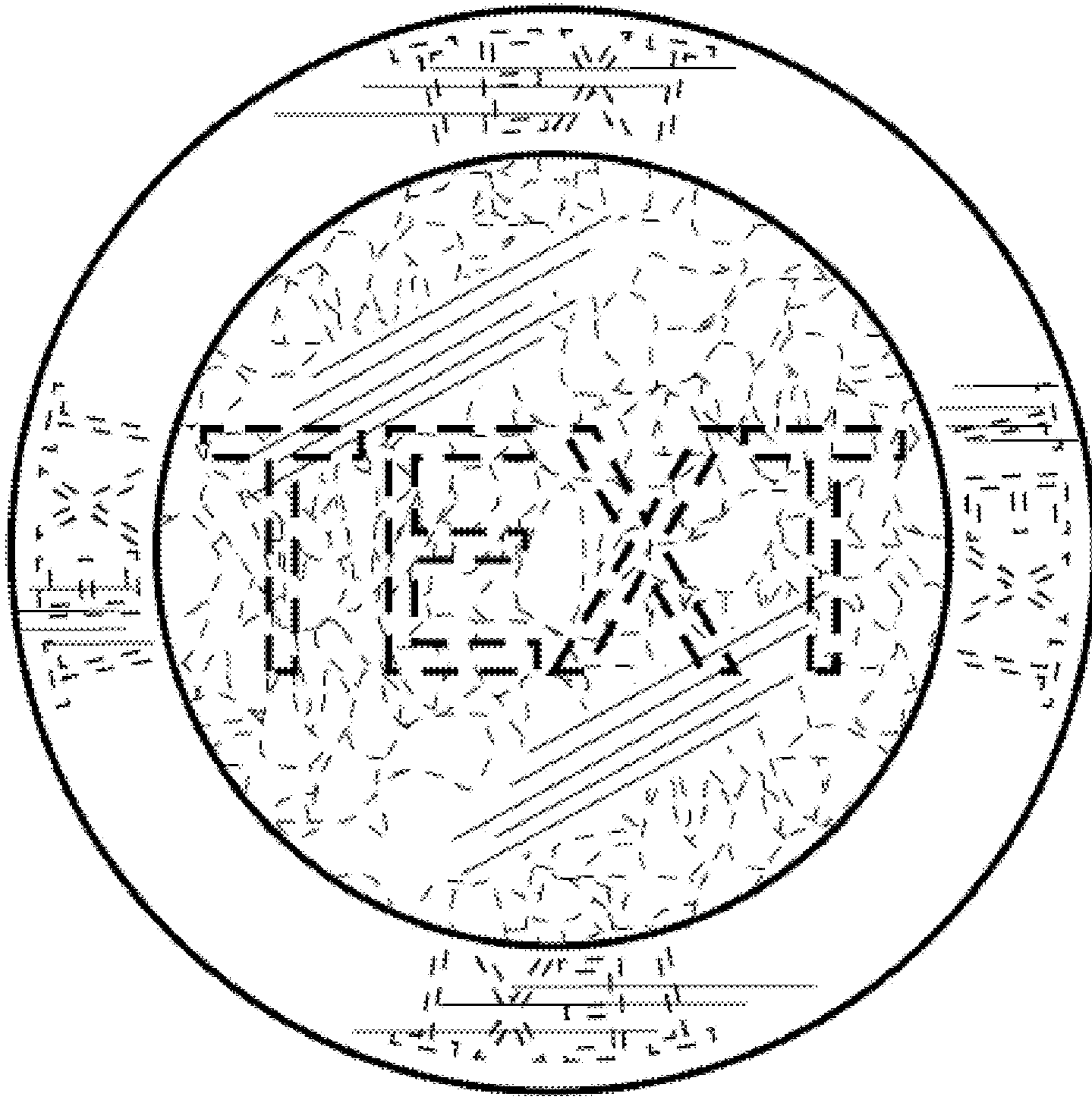

FIG. 8

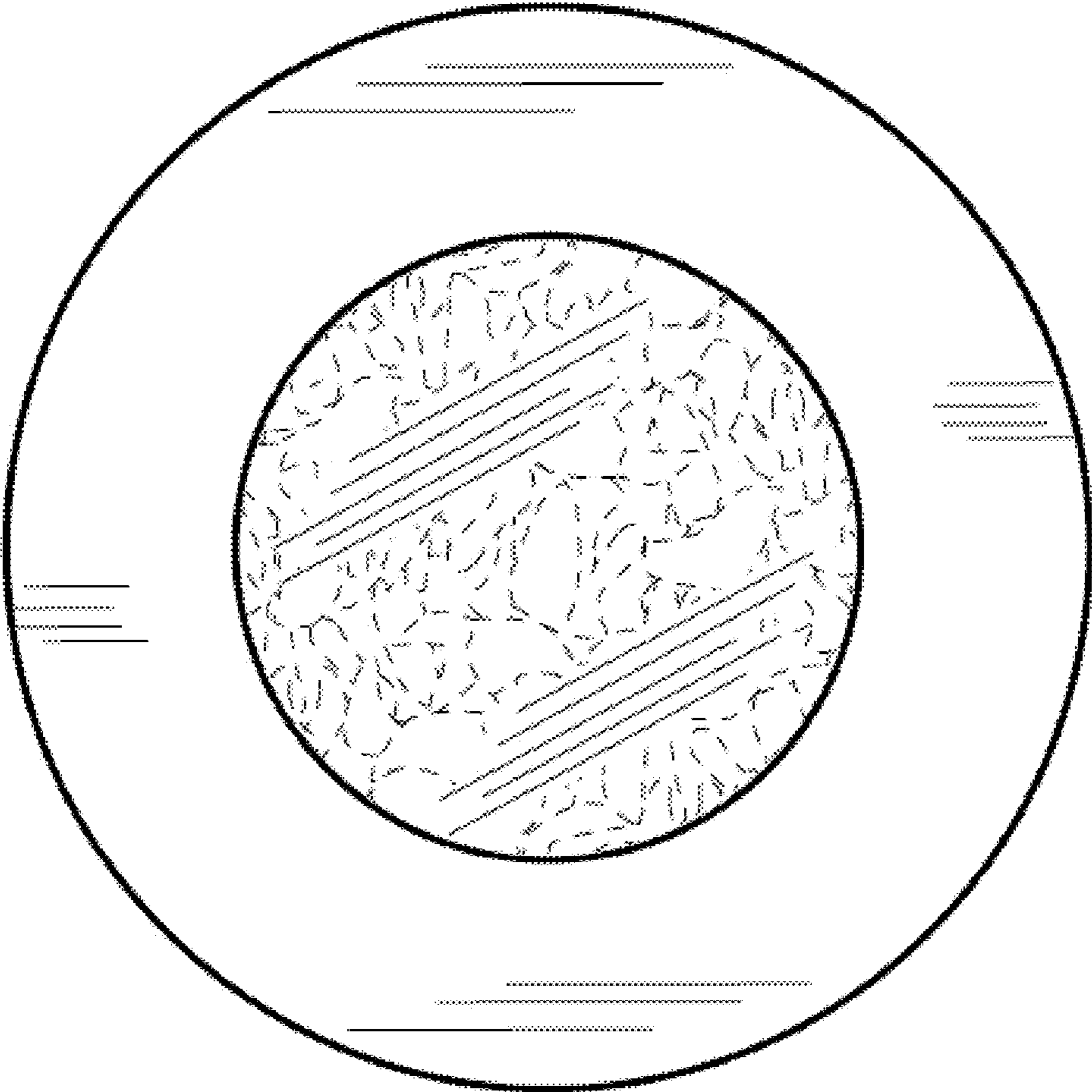

FIG. 9

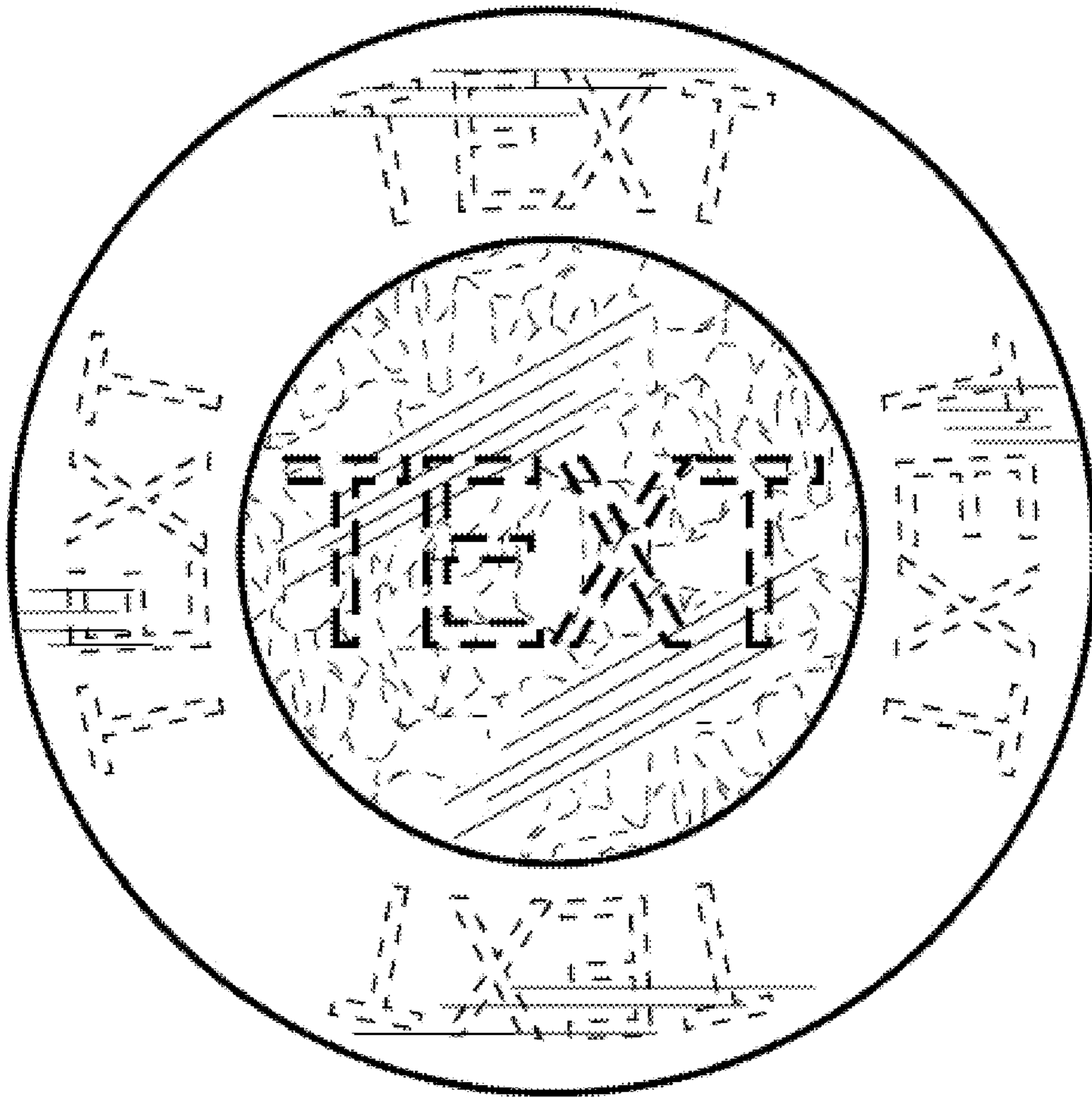

FIG. 10

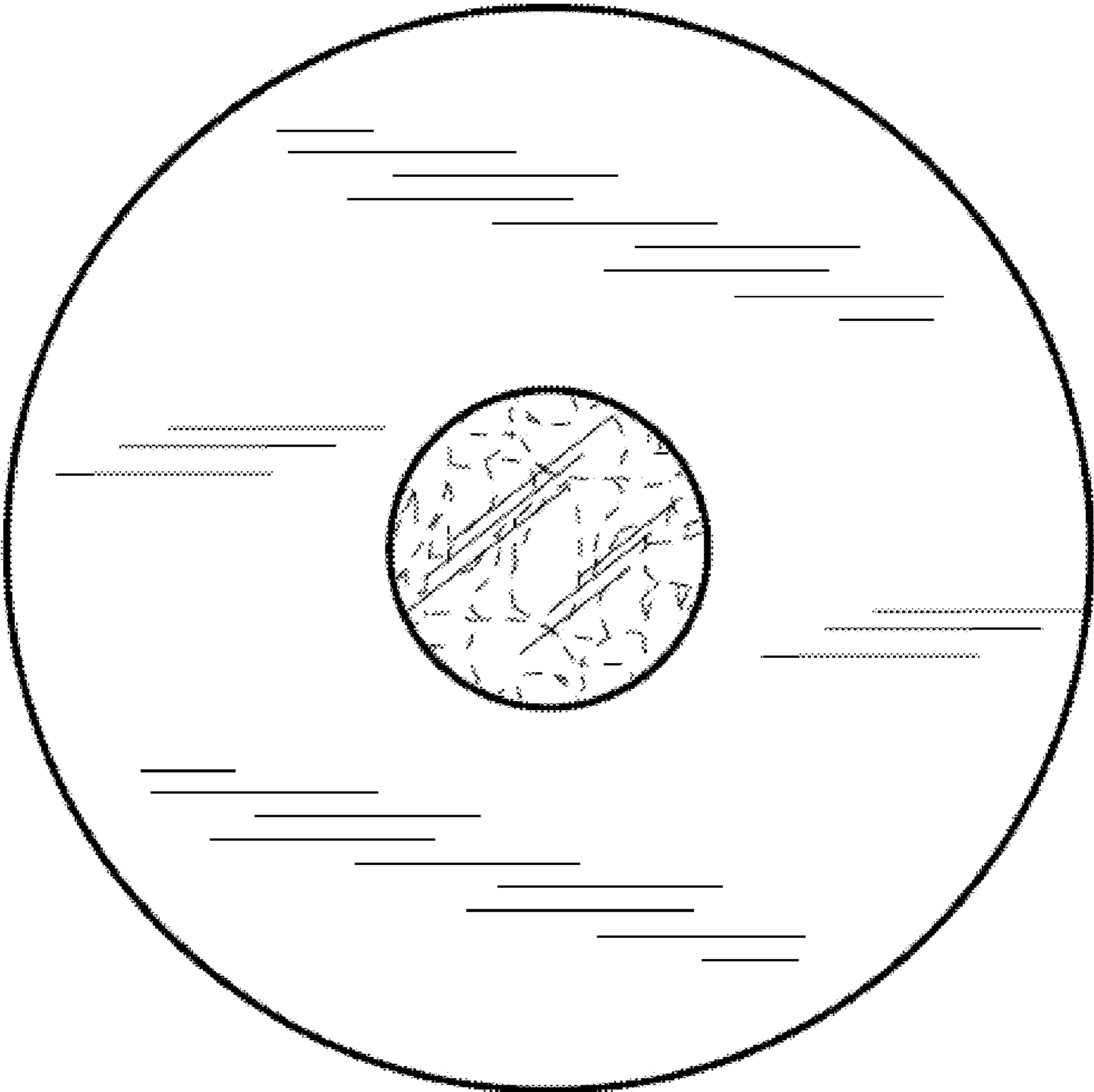

FIG. 11

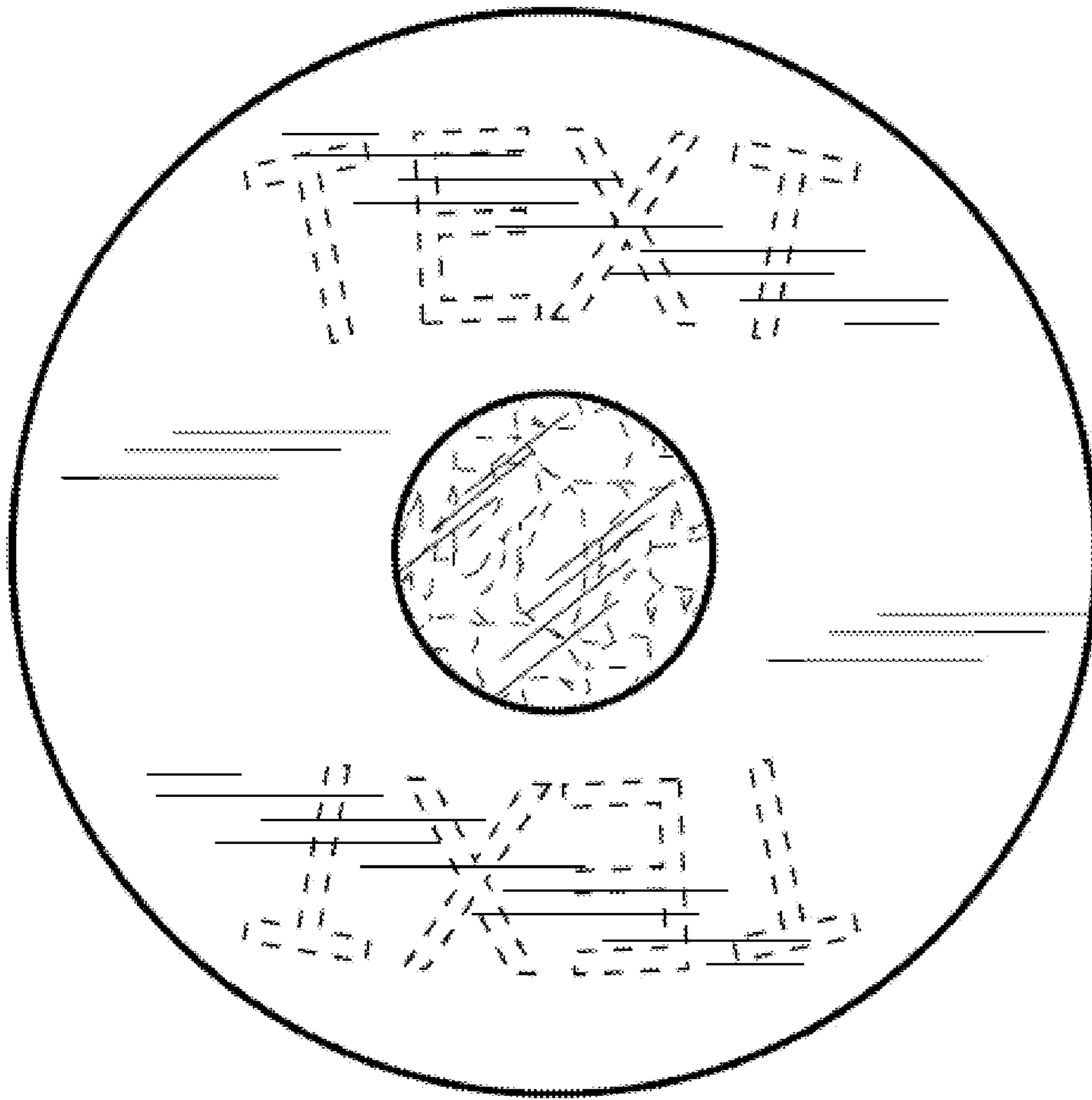

FIG. 12