



US00D732343S

(12) **United States Design Patent**  
**Romley**

(10) **Patent No.:** **US D732,343 S**  
(45) **Date of Patent:** **\*\* Jun. 23, 2015**

- (54) **INSULATED BEVERAGE CUP**
- (71) Applicant: **Michael Romley**, Phoenix, AZ (US)
- (72) Inventor: **Michael Romley**, Phoenix, AZ (US)
- (\*\*) Term: **14 Years**
- (21) Appl. No.: **29/472,091**
- (22) Filed: **Nov. 8, 2013**
- (51) **LOC (10) Cl.** ..... **07-01**
- (52) **U.S. Cl.**  
USPC ..... **D7/532**
- (58) **Field of Classification Search**  
USPC ..... D7/507, 509–512, 523, 531, 532, 533,  
D7/535, 536, 392, 392.1, 396.2, 608;  
D9/500, 502–504; 220/705–709  
CPC ..... A47G 19/22–19/2222; A47G  
19/2266–19/2272; B65D 1/265; B65D  
81/3865–1/3886  
See application file for complete search history.

D475,243 S \* 6/2003 Trazzi ..... D7/532  
D570,159 S \* 6/2008 McGill ..... D7/532  
D679,947 S 4/2013 Romley

(Continued)

**OTHER PUBLICATIONS**

Tervis, Design Collection, <http://www.tervis.com/designs>, screen shot taken Oct. 8, 2013.

*Primary Examiner* — Susan Bennett Hattan

*Assistant Examiner* — Brett Miller

(74) *Attorney, Agent, or Firm* — Venjuris, P.C.

(57) **CLAIM**

The ornamental design for an insulated beverage cup, as shown and described.

**DESCRIPTION**

FIG. 1 is a top front perspective view of an insulated beverage cup embodying the new design, with a portion in dotted lines representing portions of a matching lid that form no part of the claimed design;

FIG. 2 is a side view of the insulated beverage cup of FIG. 1; FIG. 3 is a side view of the insulated beverage cup of FIG. 1; FIG. 4 is a front view of the insulated beverage cup of FIG. 1; FIG. 5 is a rear view of the insulated beverage cup of FIG. 1; FIG. 6 is a top view of the insulated beverage cup of FIG. 1; FIG. 7 is a bottom view of the insulated beverage cup of FIG. 1;

FIG. 8 is a sectional view of the insulated beverage cup taken along cut line 8-8 of FIG. 6;

FIG. 9 is a top view of the insulated beverage cup of FIG. 1 without the unclaimed portion representing of the matching lid; and,

FIG. 10 is a top front perspective view of the insulated beverage cup of FIG. 1 without the unclaimed portion representing the matching lid.

A lid assembly for the insulated beverage cup is shown in broken lines for illustrative purposes only and forms no part of the claimed design.

**1 Claim, 6 Drawing Sheets**

(56) **References Cited**

**U.S. PATENT DOCUMENTS**

2,905,350	A *	9/1959	Edwards	.....	215/373
3,009,603	A *	11/1961	Stockdale	.....	D7/532
D199,336	S *	10/1964	Wanderer	.....	D7/532
3,169,688	A *	2/1965	Schad	.....	229/400
D208,872	S *	10/1967	Davis	.....	D7/531
3,372,830	A *	3/1968	Edwards	.....	206/519
D210,767	S *	4/1968	Anglada	.....	D7/532
3,375,954	A *	4/1968	Honkanen et al.	.....	206/520
3,397,867	A *	8/1968	van't Hoff	.....	366/341
3,850,361	A *	11/1974	Day et al.	.....	229/400
D272,794	S *	2/1984	Dart	.....	D7/532
D356,503	S *	3/1995	Mueller et al.	.....	D7/523
D436,295	S *	1/2001	Furman et al.	.....	D7/523
D446,687	S *	8/2001	Furman et al.	.....	D7/523
6,554,154	B1 *	4/2003	Chauhan et al.	.....	220/671

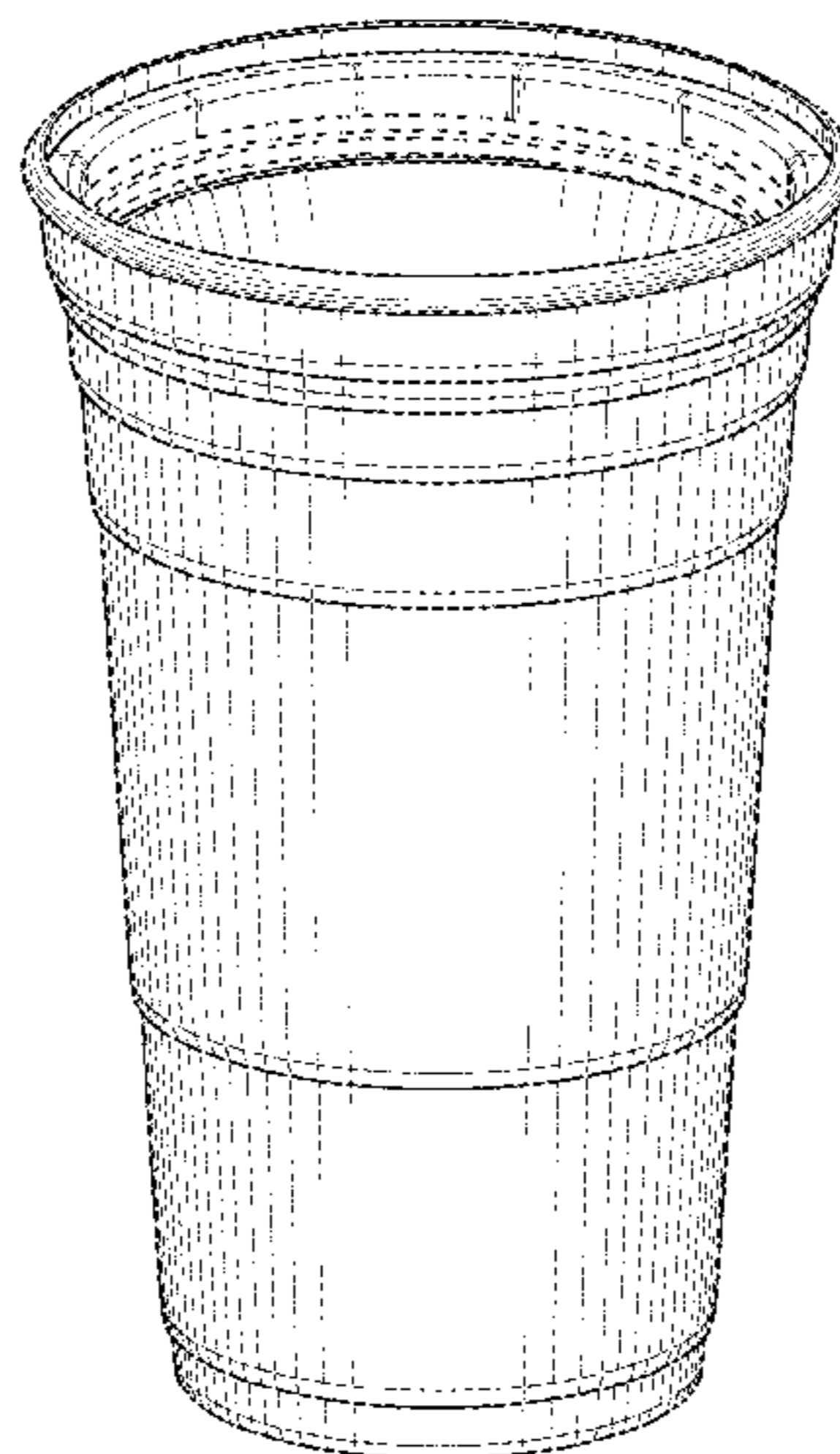

(56)

**References Cited**

U.S. PATENT DOCUMENTS

D680,376 S 4/2013 Romley  
D680,377 S 4/2013 Romley  
D680,378 S 4/2013 Romley

D717,605 S \* 11/2014 Kristinik ..... D7/532  
D717,606 S \* 11/2014 Kristinik ..... D7/532  
2005/0189361 A1\* 9/2005 Bresler ..... 220/703  
2014/0263367 A1\* 9/2014 Robertson et al. .... 220/592.2

\* cited by examiner

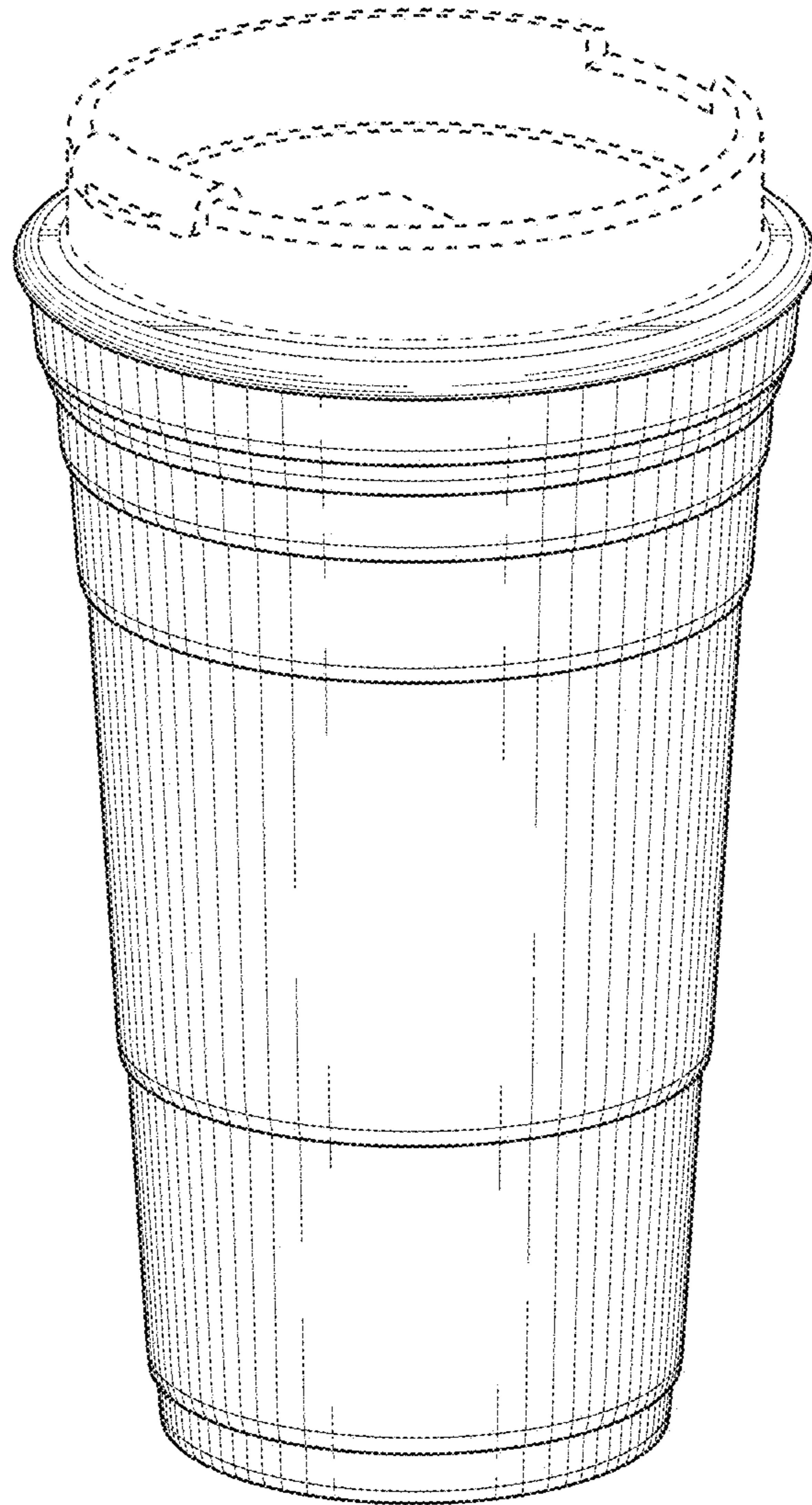

FIG. 1

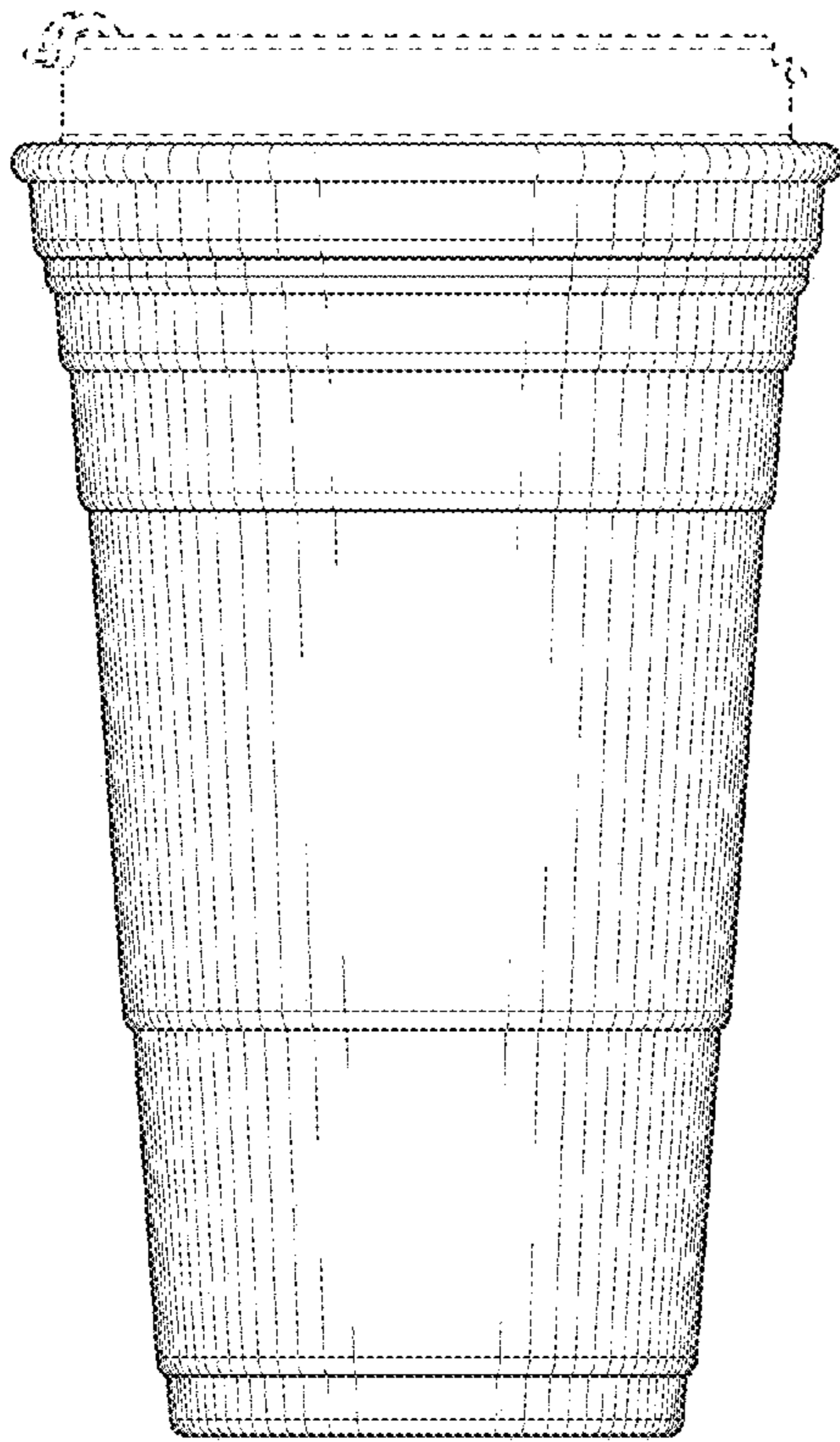

FIG. 2

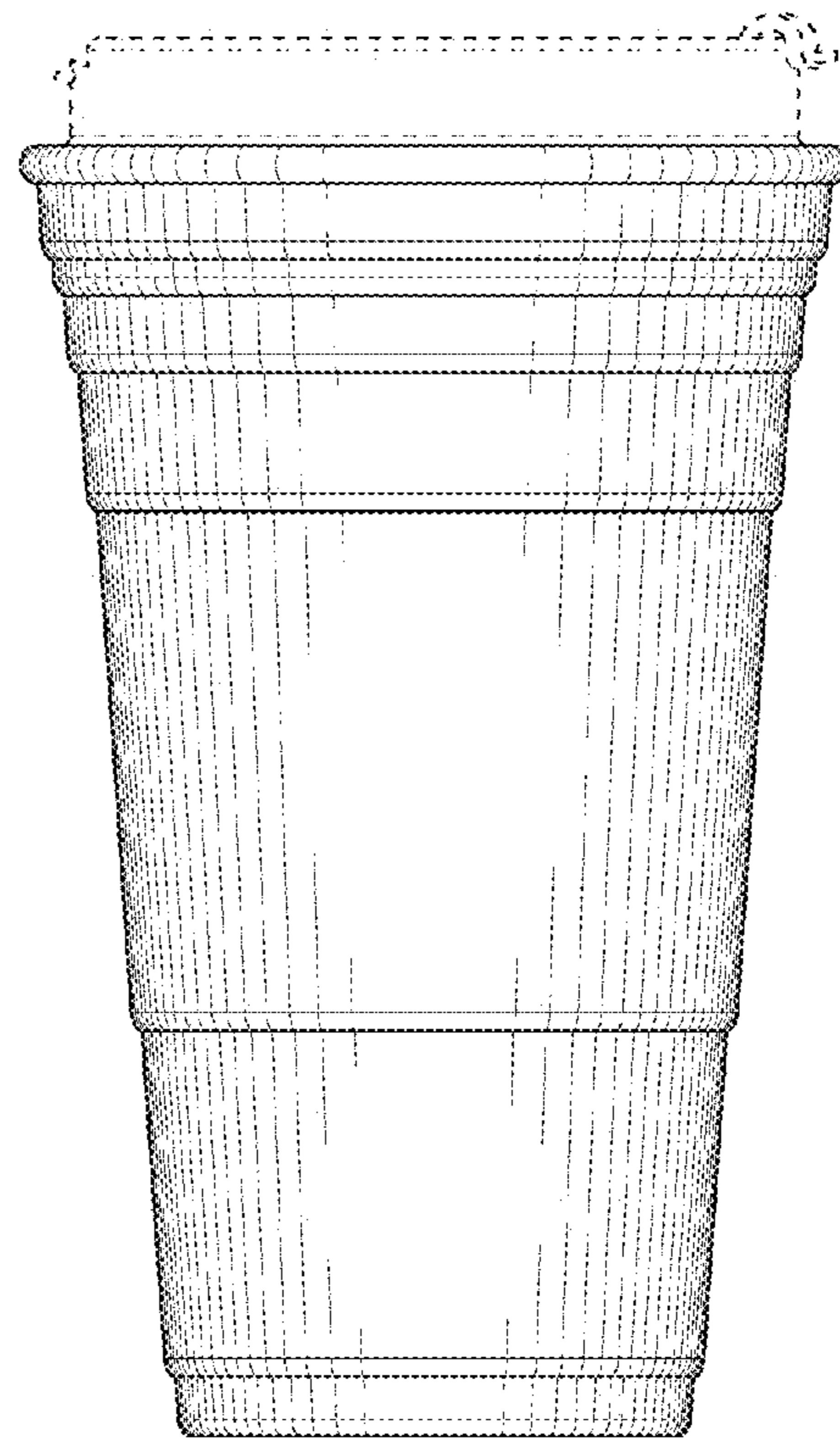

FIG. 3

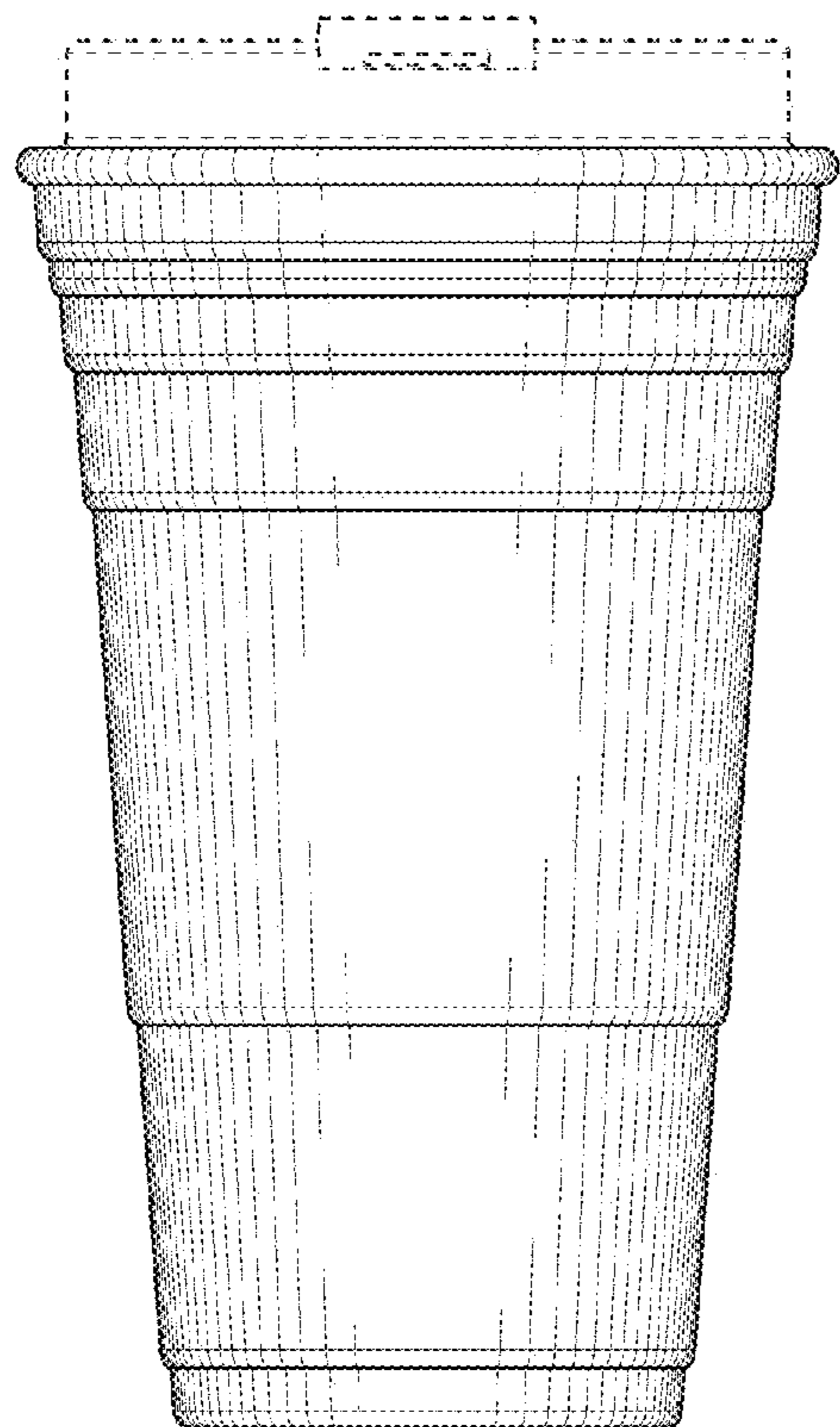

FIG. 4

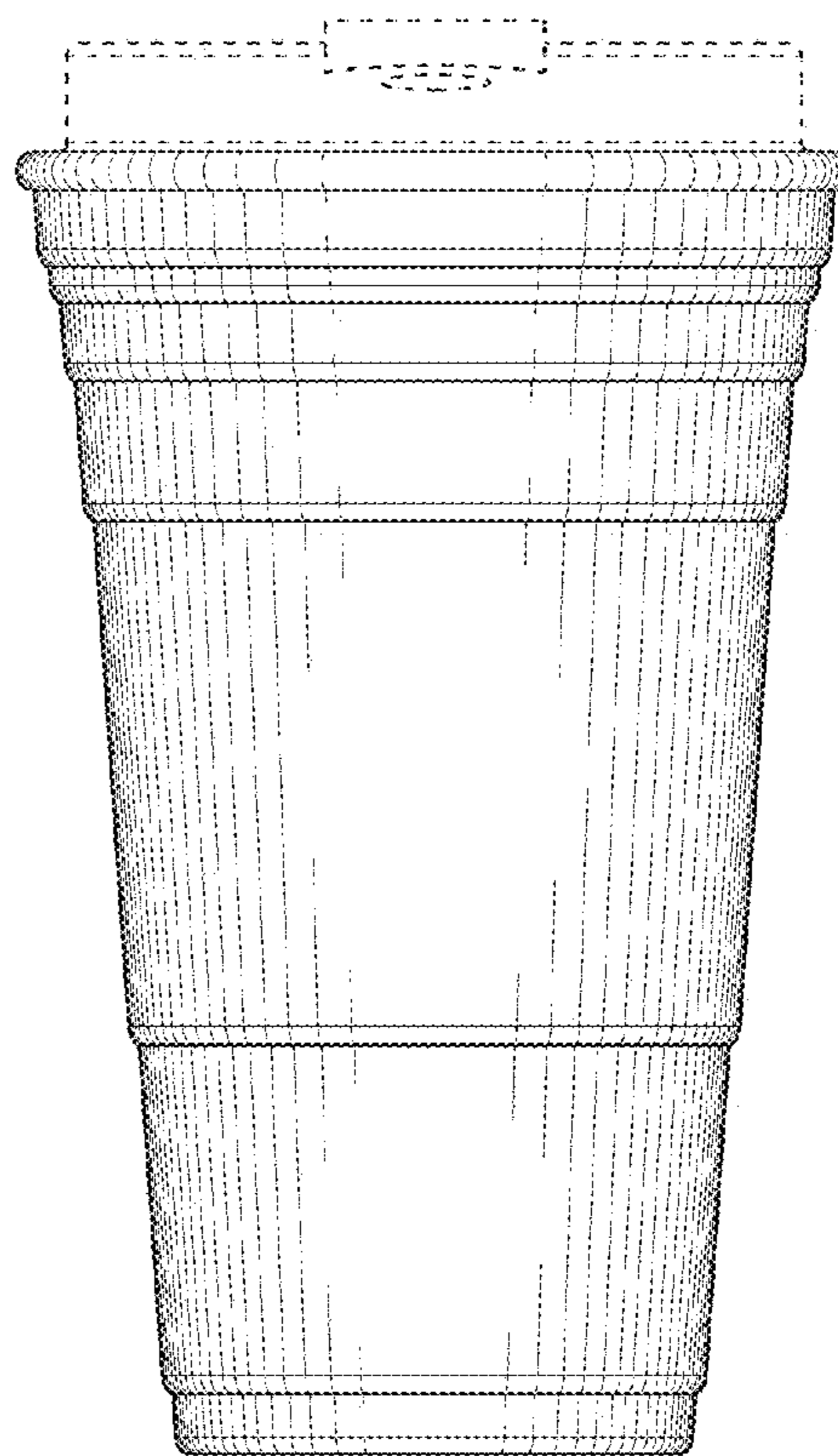

FIG. 5

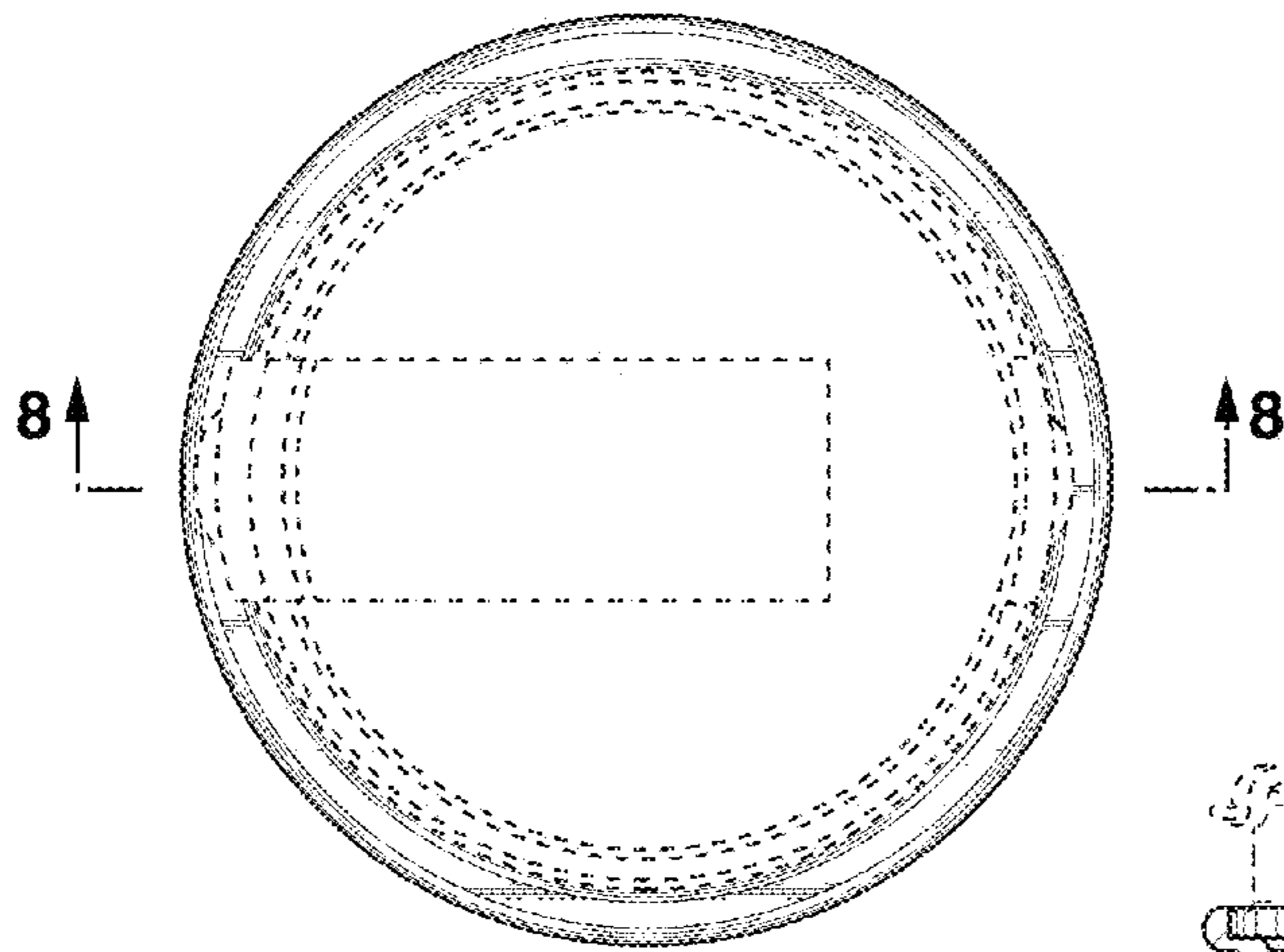

FIG. 6

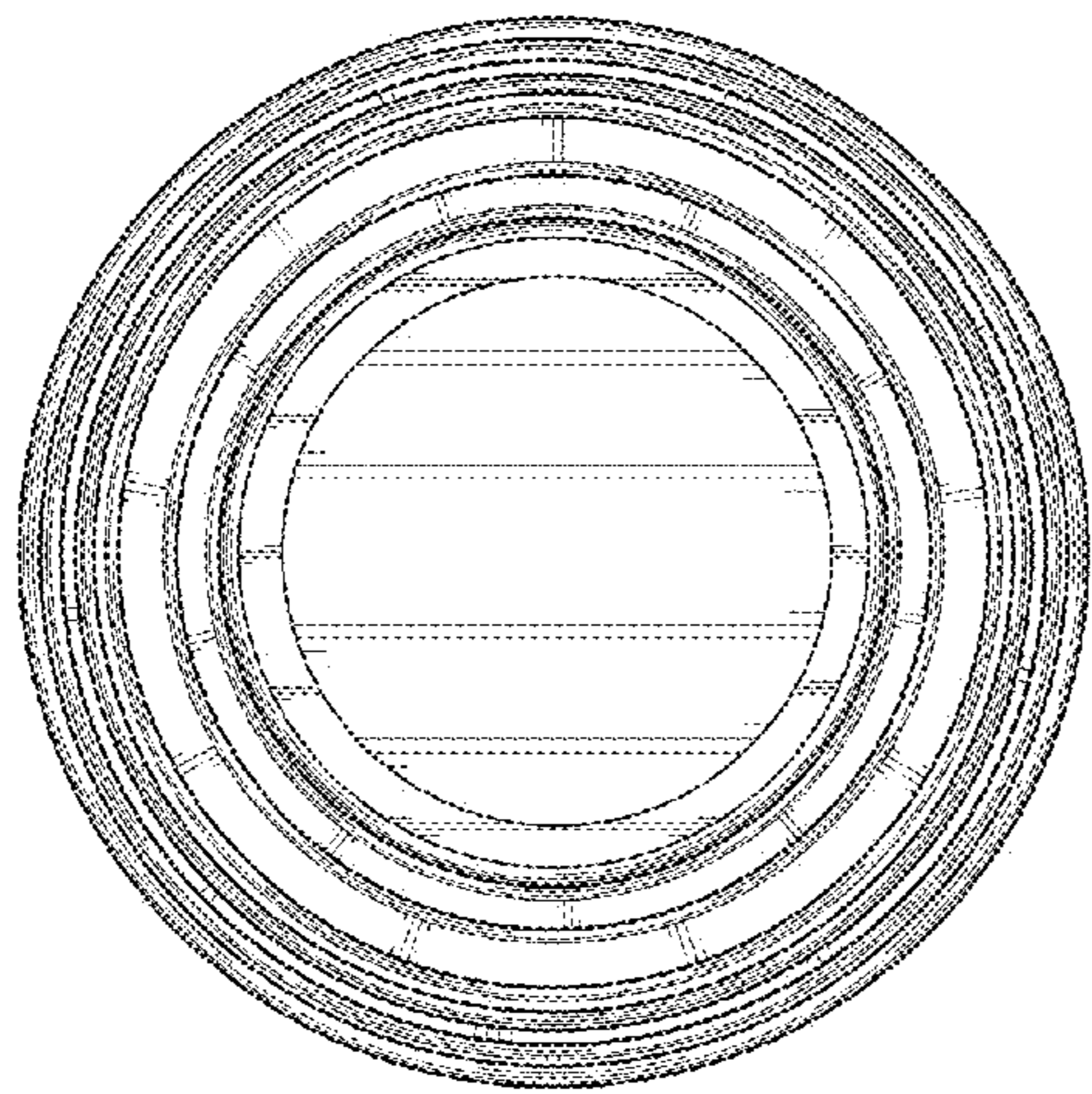

FIG. 7

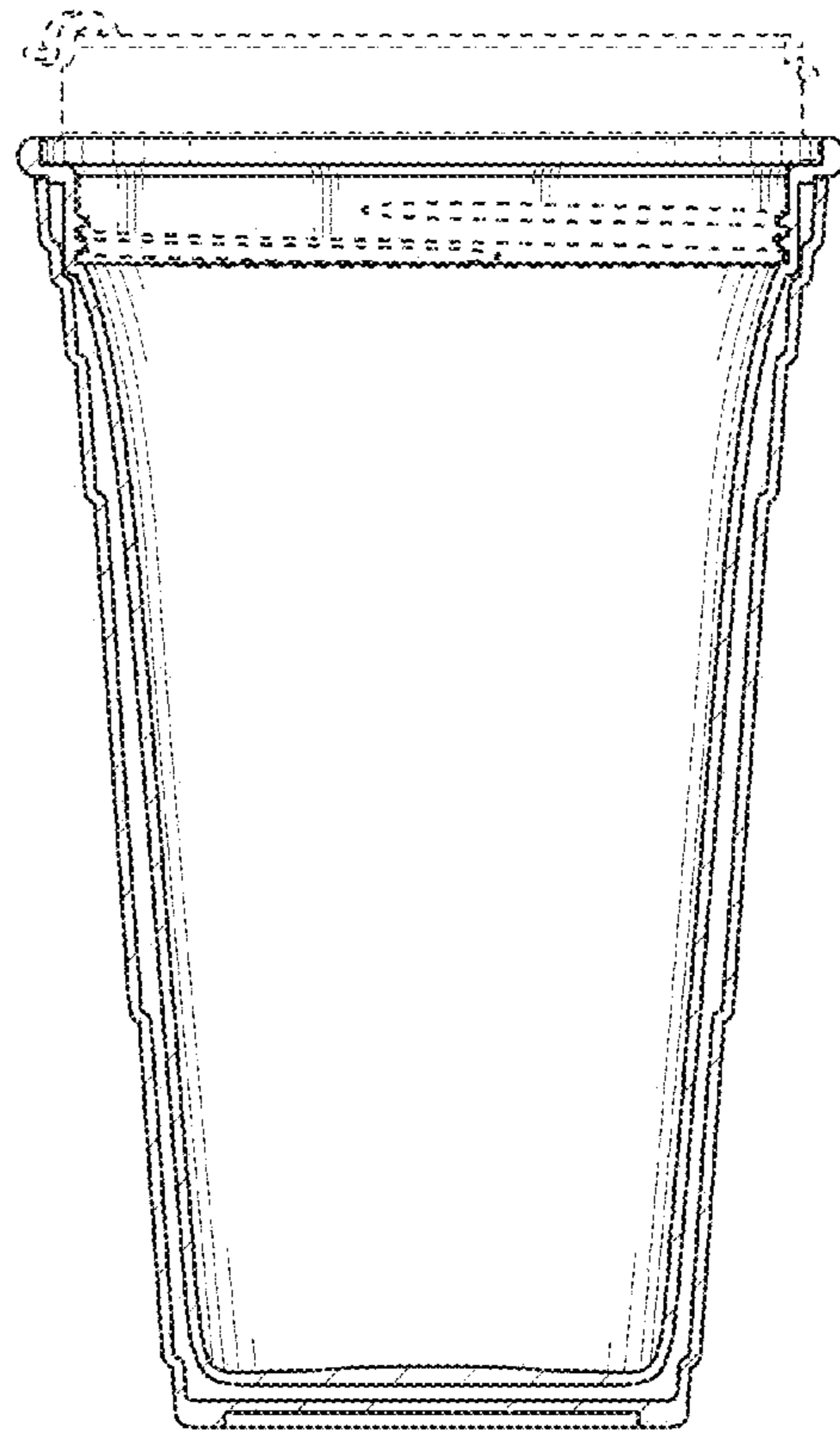

FIG. 8

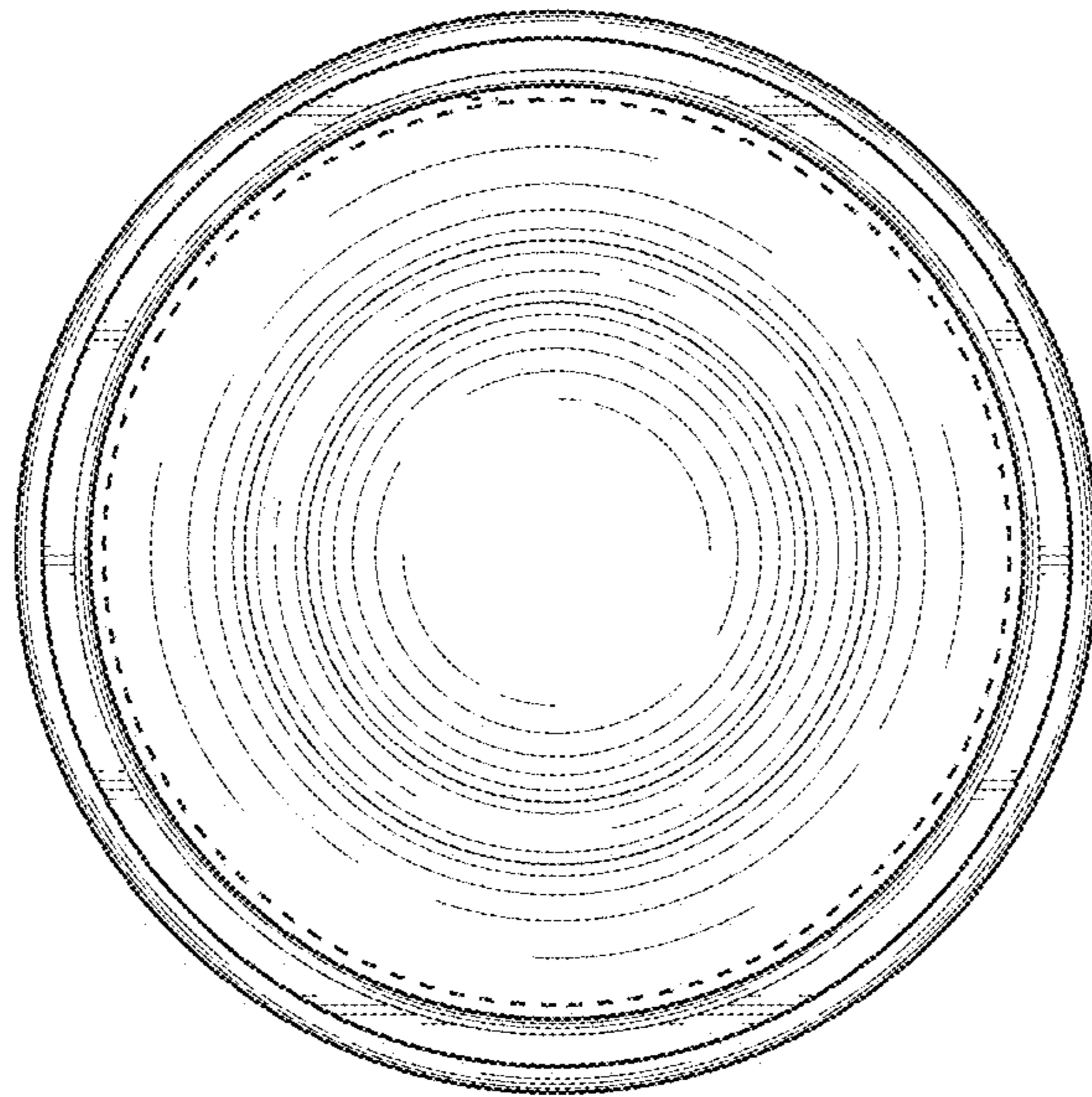

FIG. 9

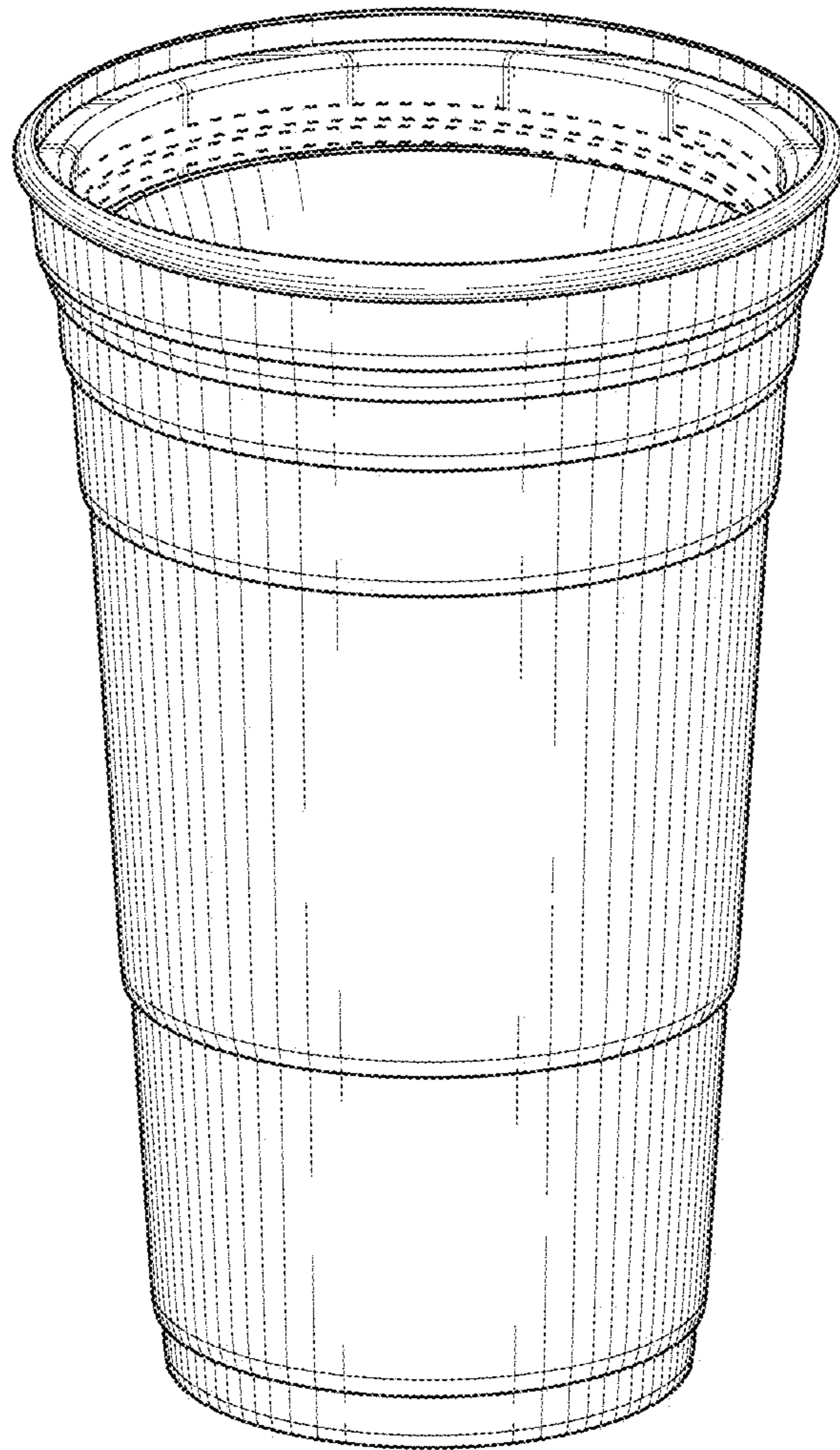

FIG. 10