



US00D732326S

(12) **United States Design Patent**
Kitano et al.

(10) **Patent No.:** **US D732,326 S**

(45) **Date of Patent:** **** Jun. 23, 2015**

(54) **BEER DISPENSER**

(56) **References Cited**

(71) Applicants: **Junichi Kitano**, Moriya (JP); **Kenji Kato**, Tokyo (JP); **Teruhiko Kitamura**, Tokyo (JP)

U.S. PATENT DOCUMENTS

2,876,042	A	*	3/1959	Steele	239/445
3,355,068	A	*	11/1967	Harland et al.	222/30
D280,880	S	*	10/1985	Schweres	D7/398
D411,710	S	*	6/1999	Watters et al.	D7/398
D483,609	S	*	12/2003	Guadalupi	D7/398
D485,121	S	*	1/2004	Ahlgrim et al.	D7/398
D590,207	S	*	4/2009	Bronwasser	D7/398
D636,224	S	*	4/2011	Shin	D7/398
D694,055	S	*	11/2013	Hirst	D7/306
D702,475	S	*	4/2014	Dalton et al.	D7/306
D708,011	S	*	7/2014	Liberatore	D7/398

(72) Inventors: **Junichi Kitano**, Moriya (JP); **Kenji Kato**, Tokyo (JP); **Teruhiko Kitamura**, Tokyo (JP)

(73) Assignee: **ASAHI BREWERIES, LTD.**, Tokyo (JP)

* cited by examiner

(**) Term: **14 Years**

Primary Examiner — Marianne Pandozzi

(21) Appl. No.: **29/463,507**

(74) *Attorney, Agent, or Firm* — Manabu Kanesaka

(22) Filed: **Dec. 16, 2013**

(57) **CLAIM**

The ornamental design for a beer dispenser, as shown and described.

(30) **Foreign Application Priority Data**

DESCRIPTION

Jul. 9, 2013 (JP) 2013-015605

(51) **LOC (10) Cl.** **07-01**

(52) **U.S. Cl.**
USPC **D7/306**; D7/397; D7/398

(58) **Field of Classification Search**
USPC D7/397, 301, 300, 398, 313, 306-308;
239/445, 583; 222/511, 25, 192,
222/153.02
CPC B67D 1/0084

FIG. 1 is a perspective view of a beer dispenser showing our new design;
FIG. 2 is a front view thereof;
FIG. 3 is a rear view thereof
FIG. 4 is a left side view thereof;
FIG. 5 is a right side view thereof;
FIG. 6 is a top plan view thereof; and,
FIG. 7 is a bottom view thereof.
The broken lines in FIG. 7 are included for the purpose of illustration and form no part of the claimed design.

See application file for complete search history.

1 Claim, 7 Drawing Sheets

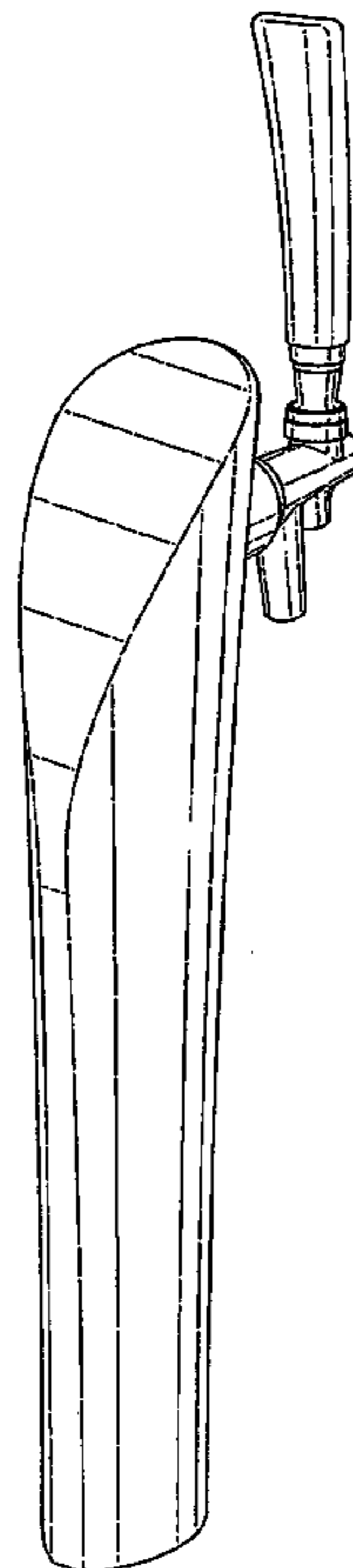

Fig. 1

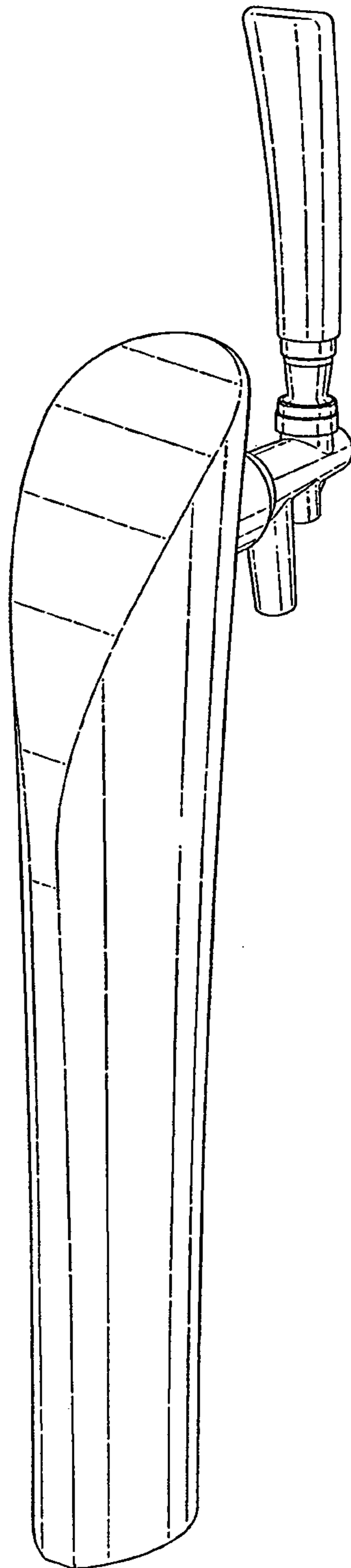

Fig. 2

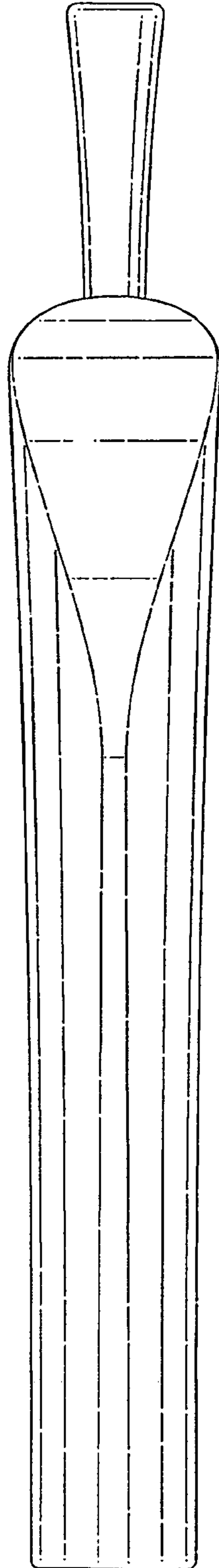

Fig. 3

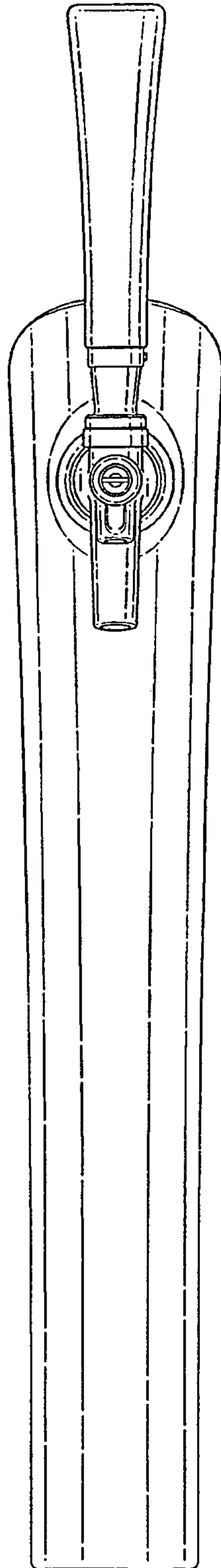

Fig. 4

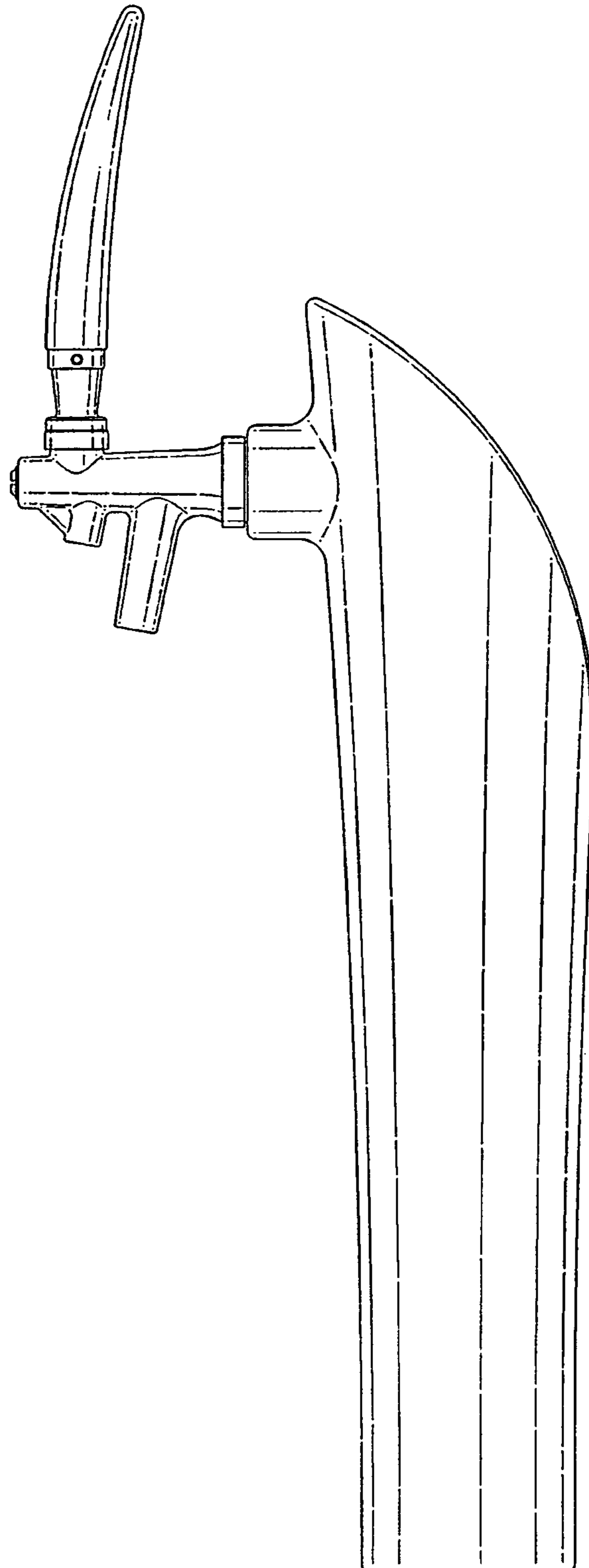

Fig. 5

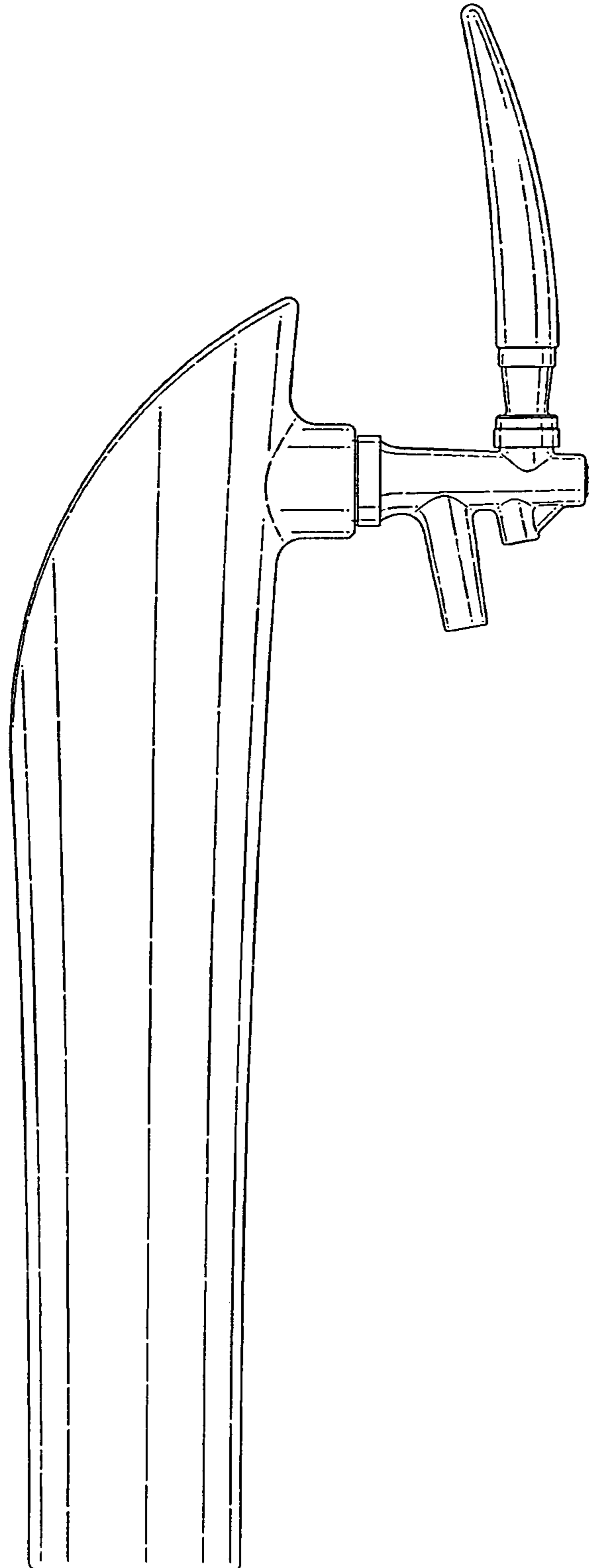

Fig. 6

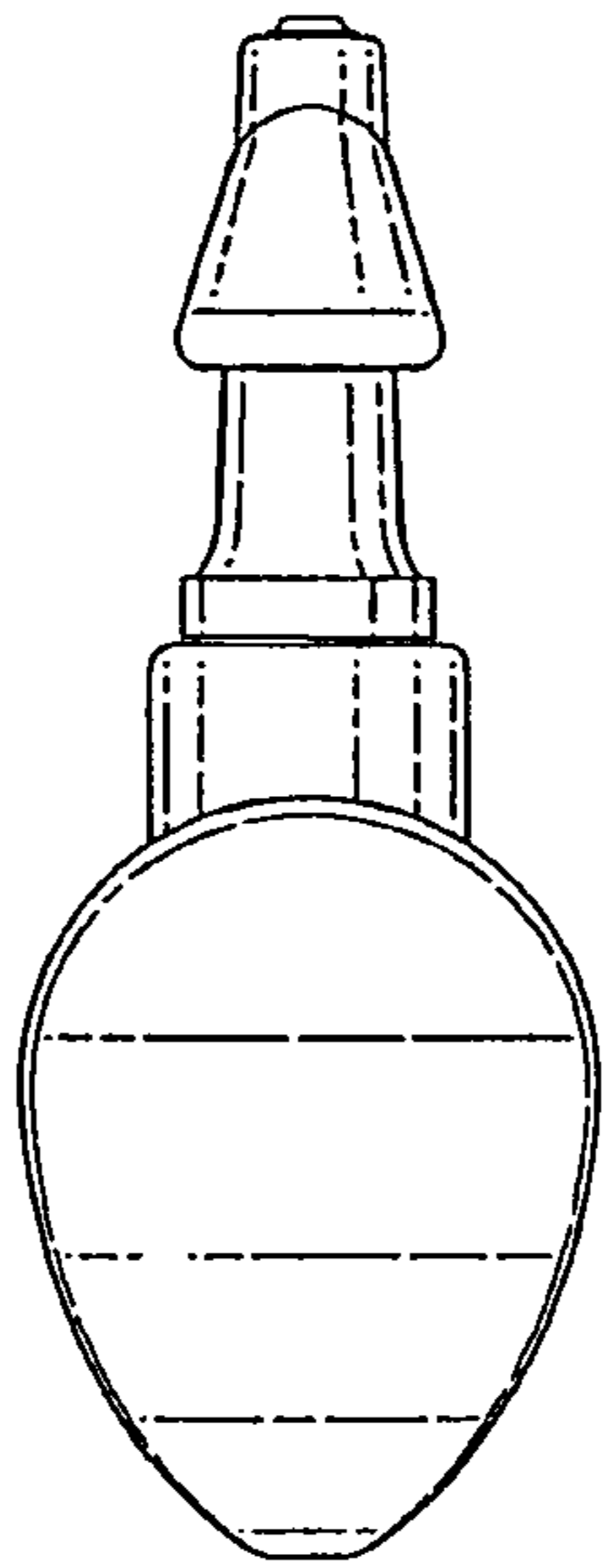

Fig. 7

