



US00D732255S

(12) **United States Design Patent**
Edwins

(10) **Patent No.:** **US D732,255 S**
(45) **Date of Patent:** **** Jun. 16, 2015**

(54) **GRILL ROD CLEANER TOOL**

(71) Applicant: **John D. Edwins**, San Diego, CA (US)

(72) Inventor: **John D. Edwins**, San Diego, CA (US)

(**) Term: **14 Years**

(21) Appl. No.: **29/469,308**

(22) Filed: **Oct. 9, 2013**

(51) **LOC (10) Cl.** **08-05**

(52) **U.S. Cl.**
USPC **D32/49**

(58) **Field of Classification Search**
USPC D8/45, 63, 93, 99, 106; D7/696, 395;
D32/40-42, 46, 48, 49; D3/210;
30/169, 170, 137, 164.8, 147-148,
30/171; 15/229.1, 236.1; D24/146-147;
D4/138, 129

See application file for complete search history.

(56) **References Cited**

U.S. PATENT DOCUMENTS

D696 S *	3/1855	Gardner	D7/653
60,650 A *	12/1866	Suine	30/123
130,923 A *	8/1872	Laurence	30/137
133,088 A *	11/1872	Feeck	15/166
582,834 A *	5/1897	Swenson	294/3
812,424 A *	2/1906	Hellmuth	30/408
1,220,479 A *	3/1917	Waymire	30/137
1,688,778 A *	10/1928	Berry	30/137
2,184,216 A *	12/1939	Gross	294/26
2,600,013 A *	6/1952	Malone	30/137
3,760,501 A *	9/1973	Johnston	30/322
D265,623 S *	8/1982	Seibel	D7/683
4,599,797 A *	7/1986	Bax	30/323
D332,554 S *	1/1993	Gomez et al.	D7/683
D389,698 S *	1/1998	Cohen et al.	D7/401.2
5,875,515 A *	3/1999	Dallas	15/236.05
D431,960 S *	10/2000	Hay	D7/401.2

D448,973 S *	10/2001	Hay et al.	D7/395
D457,033 S *	5/2002	Helman et al.	D7/401.2
D480,611 S *	10/2003	Boldt	D7/683
D513,689 S *	1/2006	Bodum	D7/653
D531,853 S *	11/2006	Zemel	D7/395

(Continued)

FOREIGN PATENT DOCUMENTS

JP	D10719173	*	5/2000
KR	300443387-0000	*	3/2007

OTHER PUBLICATIONS

Amazon Charcoal Companion Perfect Chef Barbecue Tool Set, review date Sep. 6, 2011, [online], [site visited Dec. 22, 2014 3:38:50 PM], <<http://www.amazon.com/Charcoal-Companion-Perfect-Barbecue-Handles/dp/B0009NMP6U>>.*

(Continued)

Primary Examiner — John Windmuller

Assistant Examiner — John R Yeh

(74) *Attorney, Agent, or Firm* — John K. Buche; Buche & Associates, P.C.

(57) **CLAIM**

I claim the ornamental appearance of a grill rod cleaner tool, as shown and described.

DESCRIPTION

FIG. 1 is a perspective view of the grill rod cleaner tool, FIG. 2 is a front view of the grill rod cleaner tool thereof; FIG. 3 is a back view of the grill rod cleaner tool thereof; FIG. 4 is a left-side side view of the grill rod cleaner tool thereof; FIG. 5 is a right-side view of the grill rod cleaner tool thereof; FIG. 6 is a top view of the grill rod cleaner tool thereof; and, FIG. 7 is a bottom view of the grill rod cleaner tool thereof.

1 Claim, 4 Drawing Sheets

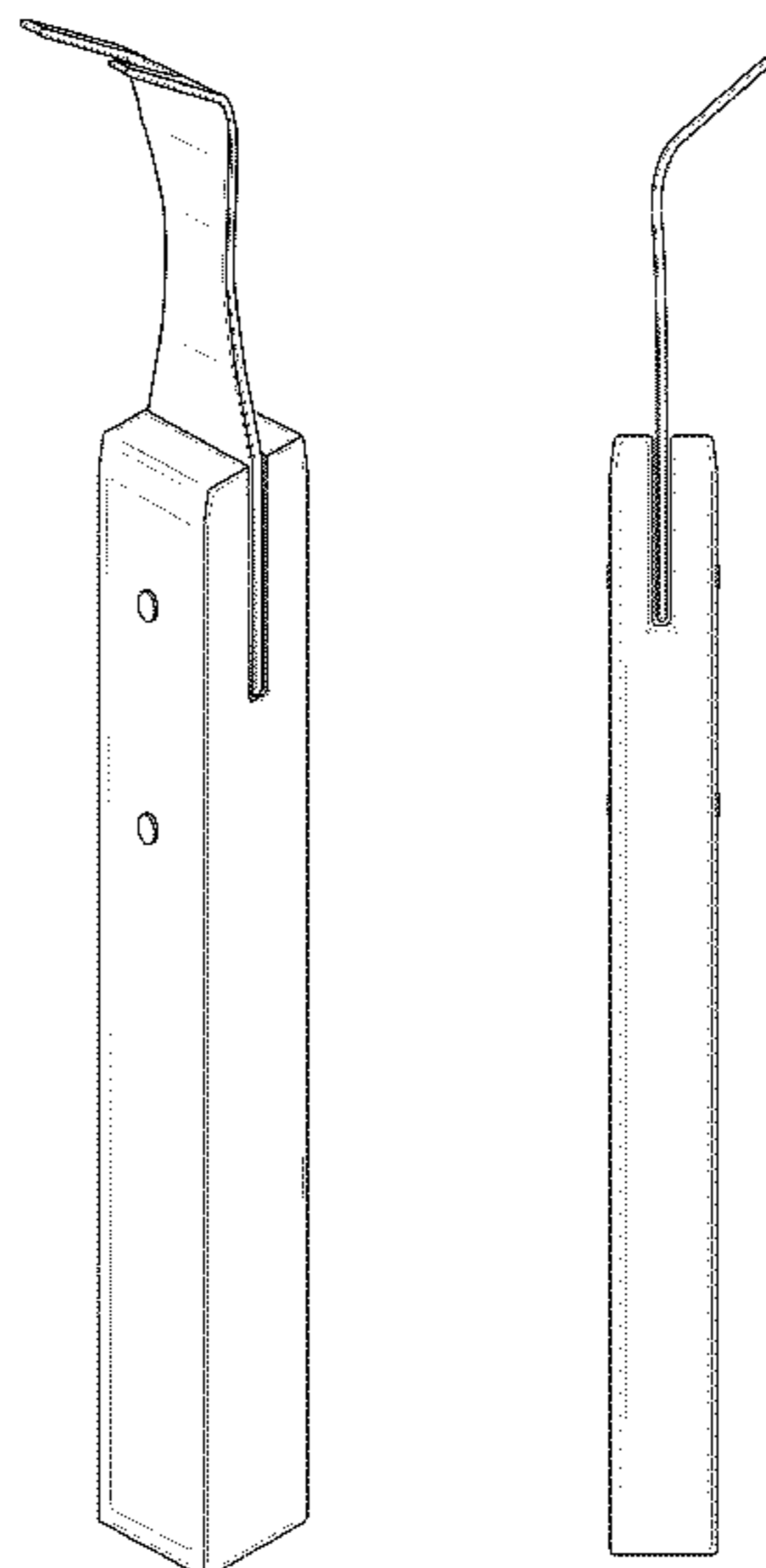

(56)

References Cited

U.S. PATENT DOCUMENTS

D565,733 S * 4/2008 Andre D24/147
D578,826 S * 10/2008 Lu D7/395
D698,211 S * 1/2014 Biever D7/669

OTHER PUBLICATIONS

Grill Utensils Stock Photo publish, date Apr. 7, 2010, [online], [site visited Dec. 22, 2014 4:41:30 PM], <<http://depositphotos.com/>

2842984/stock-photo-grill-utensils.html?sst=0&sqc=46&sqm=296&sq=37zd1b>.*

Top 5 Must-Have Tools for the Backyard BBQ Pro, wayback date Aug. 15, 2012, [online], [site visited Dec. 22, 2014 3:44:11 PM], <<http://web.archive.org/web/20120815022528/http://backyard-ideas.org/top-10-must-have-tools-for-the-backyard-bbq-pro>>.*

Uncommon goods golfers barbecue set, review date Jul. 19, 2007, [online], [site visited Dec. 22, 2014 3:41:28 PM], <<http://www.uncommongoods.com/product/golfers-bbq-set>>.*

* cited by examiner

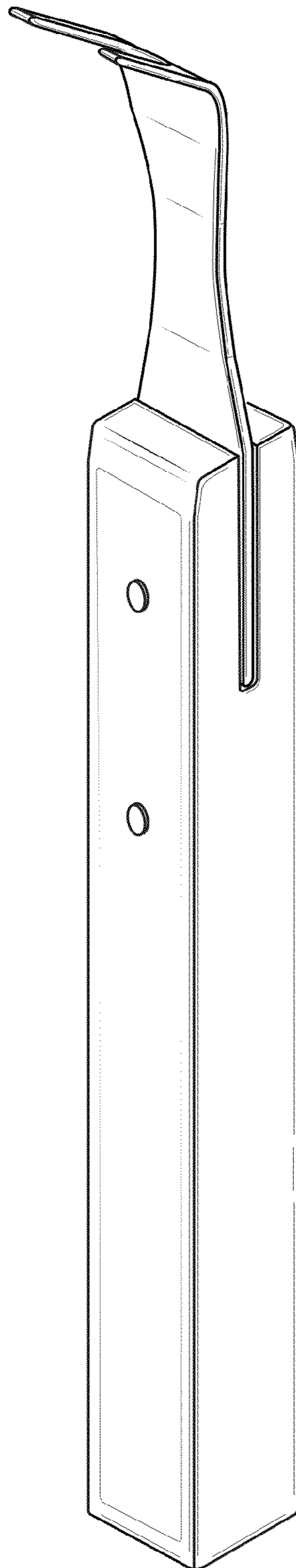

FIG. 1

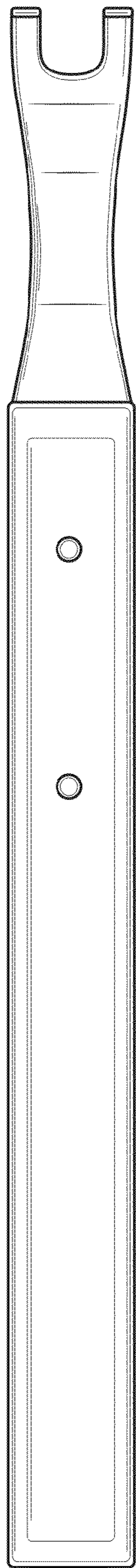

FIG. 2

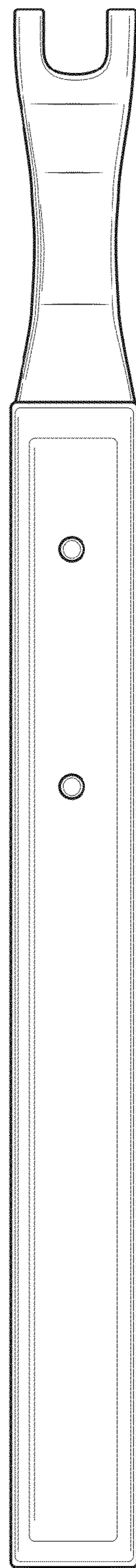

FIG. 3

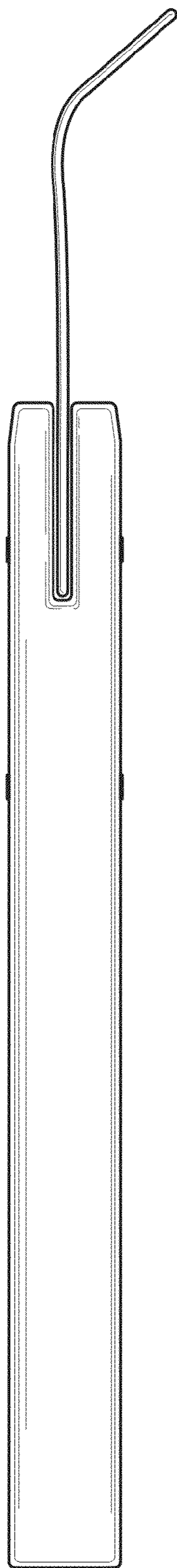

FIG. 4

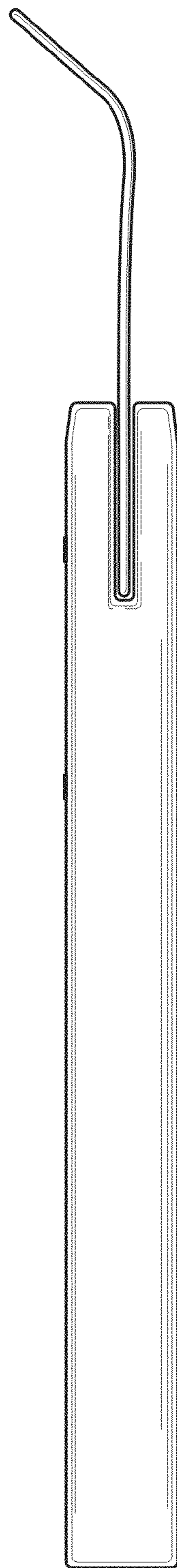

FIG. 5

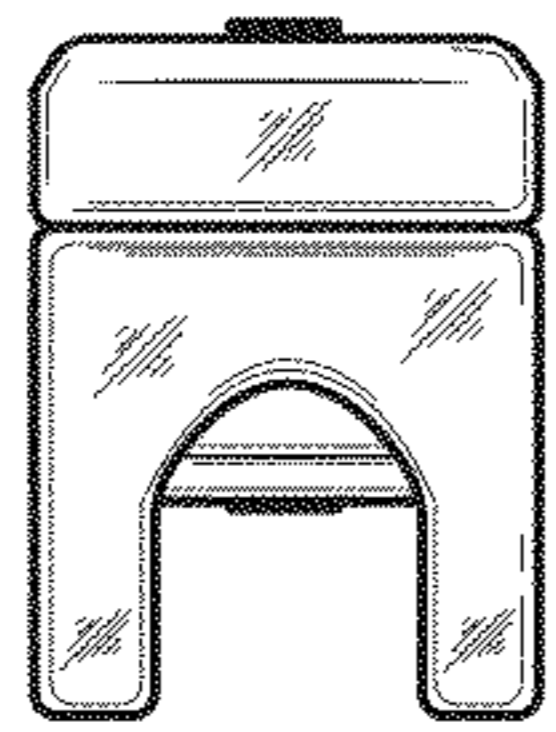

FIG. 6

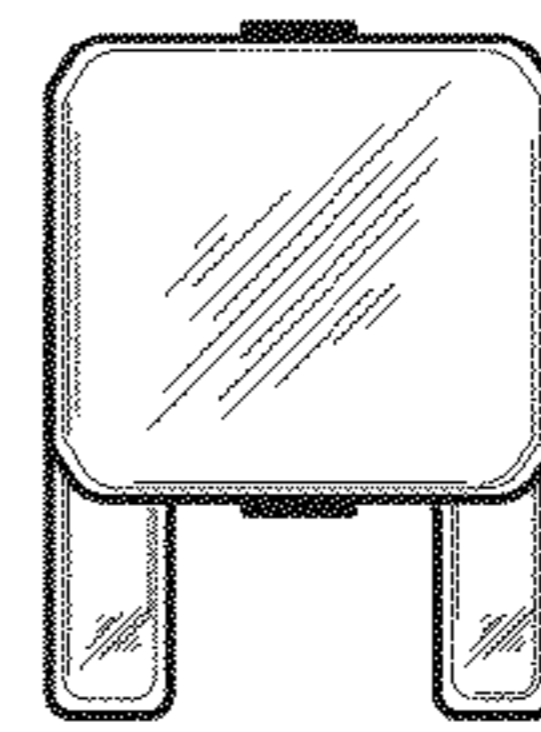

FIG. 7