



US00D732177S

(12) **United States Design Patent**
Lee

(10) **Patent No.:** **US D732,177 S**
(45) **Date of Patent:** **** Jun. 16, 2015**

(54) **HALF BODY SAUNA**
(71) Applicant: **Seung Woo Lee**, Yorba Linda, CA (US)
(72) Inventor: **Seung Woo Lee**, Yorba Linda, CA (US)
(**) Term: **14 Years**
(21) Appl. No.: **29/483,916**
(22) Filed: **Mar. 4, 2014**
(51) **LOC (10) Cl.** **23-02**
(52) **U.S. Cl.**
USPC **D24/203**
(58) **Field of Classification Search**
USPC D24/201–205; 4/524, 526, 528, 531,
4/532
See application file for complete search history.

D548,848 S * 8/2007 Schwarzenberger
et al. D24/203
7,458,111 B2 * 12/2008 Sappenfield et al. 4/524
7,784,118 B2 * 8/2010 Lee 4/531
7,784,120 B2 * 8/2010 Spicer 4/592
D663,855 S * 7/2012 Zack et al. D24/203

* cited by examiner

Primary Examiner — David Muller
(74) *Attorney, Agent, or Firm* — John K. Park; Park Law Firm

(57) **CLAIM**
The ornamental design for a half body sauna, as shown and described.

DESCRIPTION

FIG. 1 is a perspective view of a half body sauna showing my new design;
FIG. 2 is a front view thereof;
FIG. 3 is a rear view thereof;
FIG. 4 is a left side view thereof;
FIG. 5 is a right side view thereof;
FIG. 6 is a top plan view thereof;
FIG. 7 is a bottom plan view thereof; and,
FIG. 8 is a perspective view thereof in operation.
The features shown in broken lines depict environmental structure only and form no part of the claimed design.

(56) **References Cited**
U.S. PATENT DOCUMENTS
D255,267 S * 6/1980 Sinaiko D24/205
D257,490 S * 11/1980 Davis D24/202
D271,523 S * 11/1983 Richburg D24/204
5,117,481 A * 5/1992 Sung 392/416
D341,425 S * 11/1993 Lee D24/203
5,446,929 A * 9/1995 Sills et al. 4/555
D455,497 S * 4/2002 Jensen et al. D24/203
6,965,097 B2 * 11/2005 Lee 219/492

1 Claim, 5 Drawing Sheets

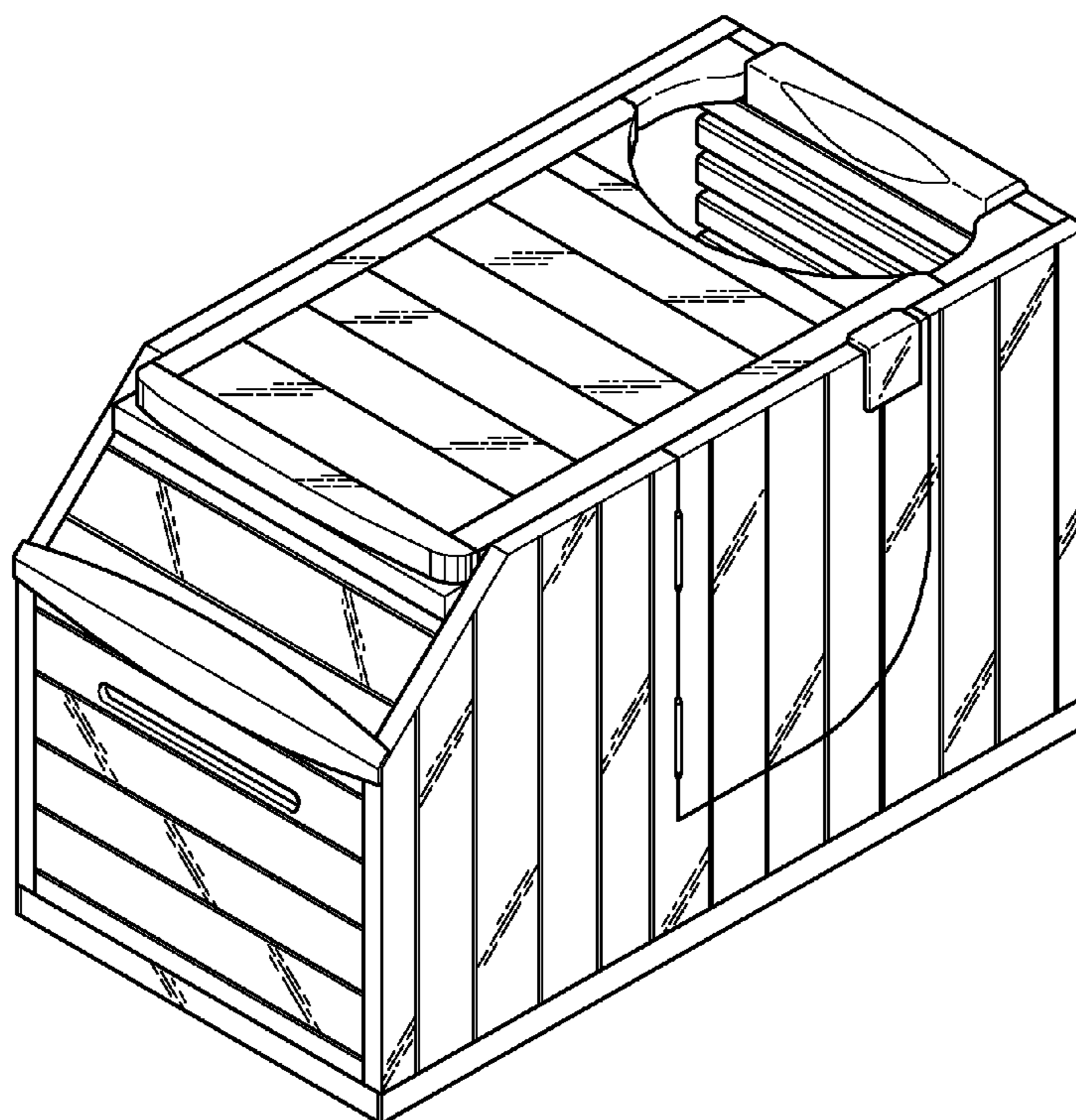

FIG. 1

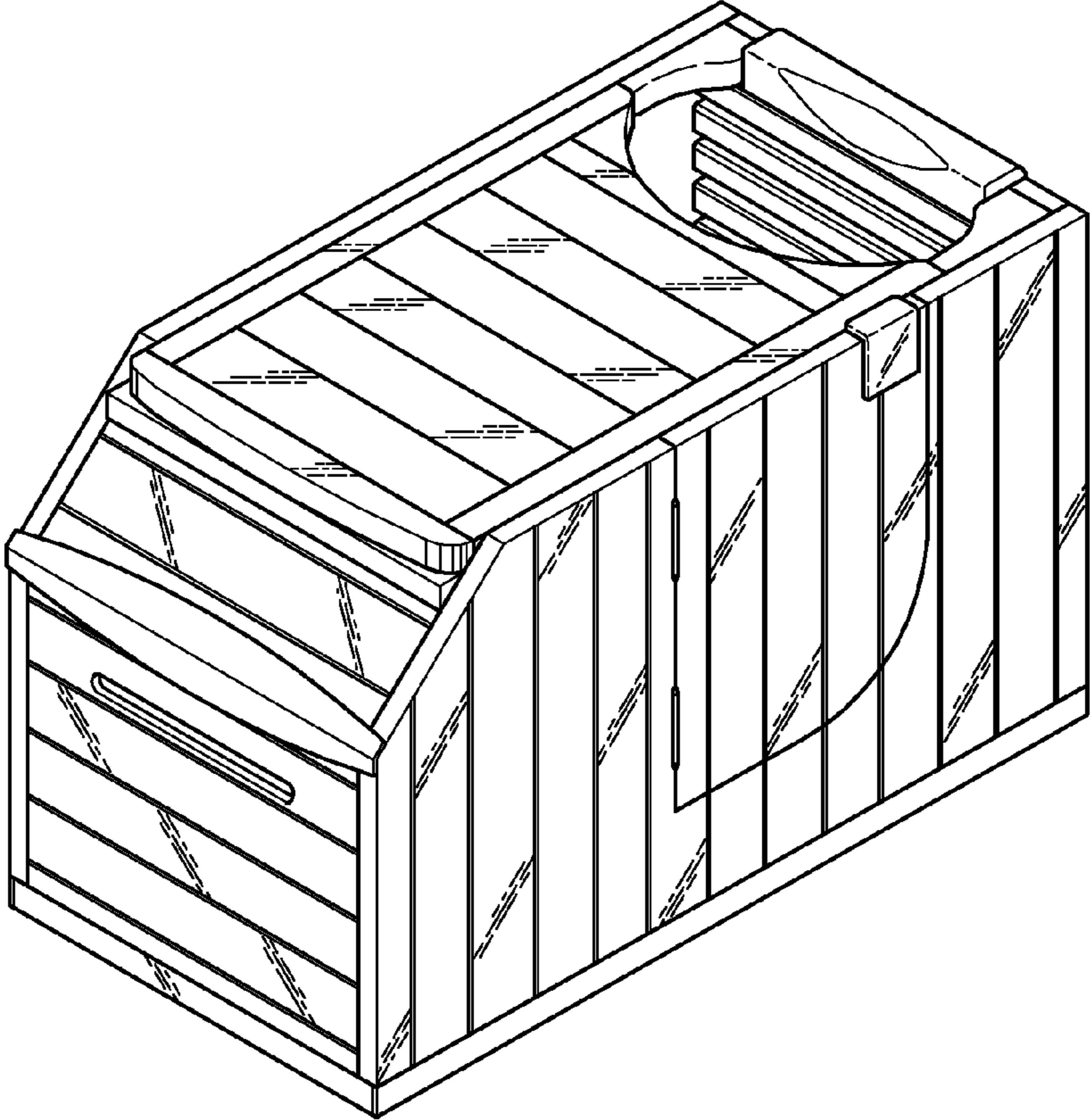

FIG. 2

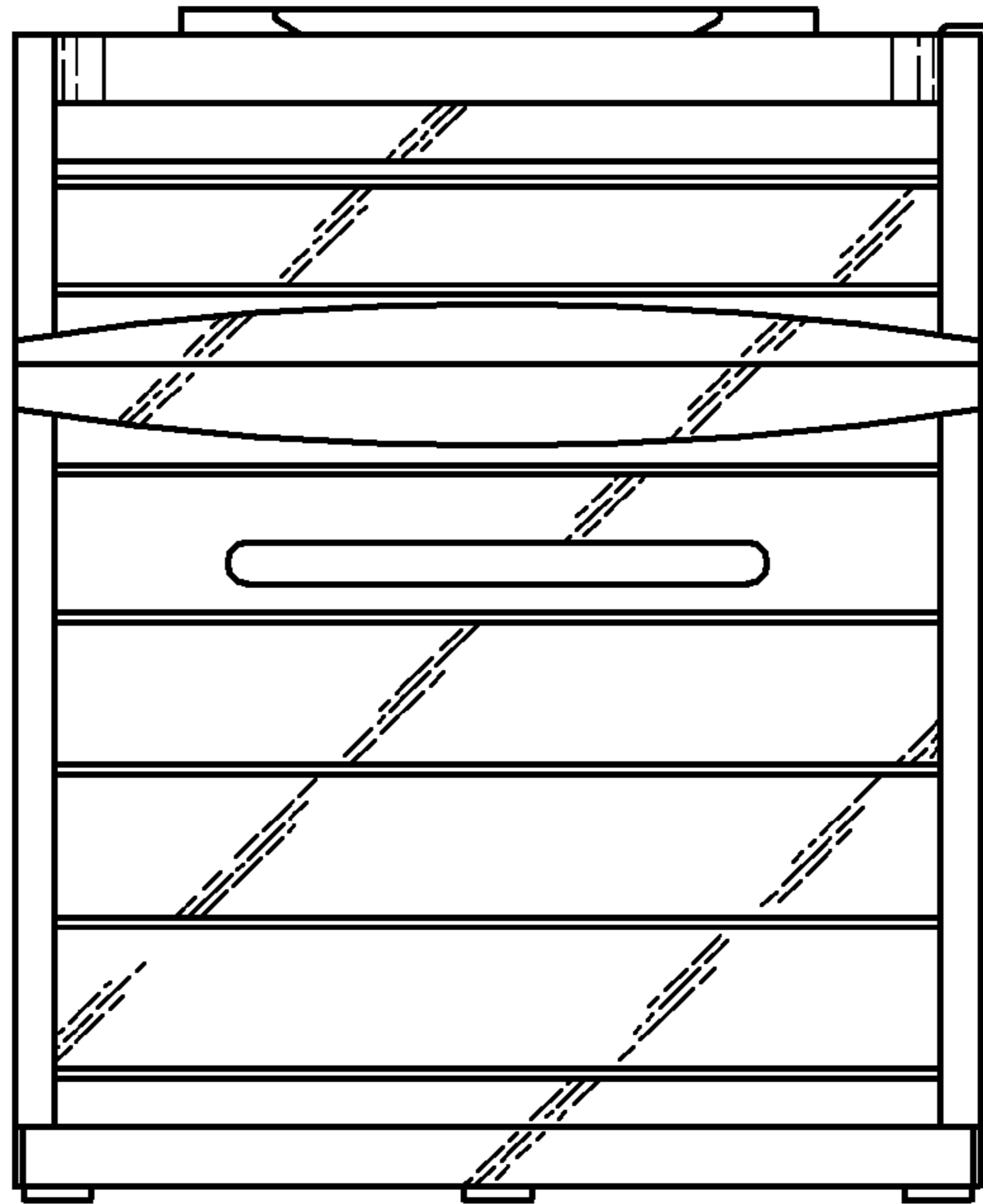

FIG. 3

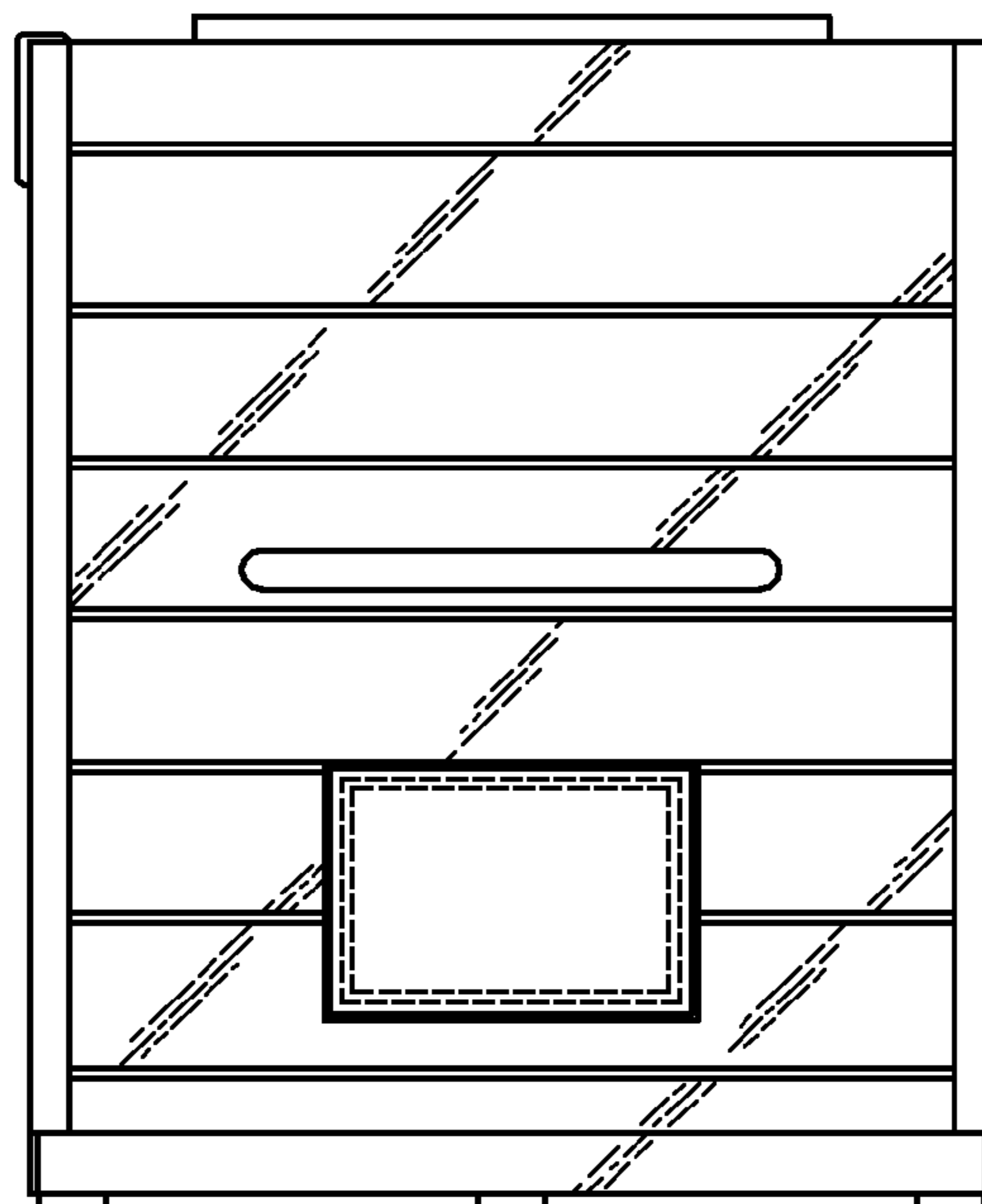

FIG. 4

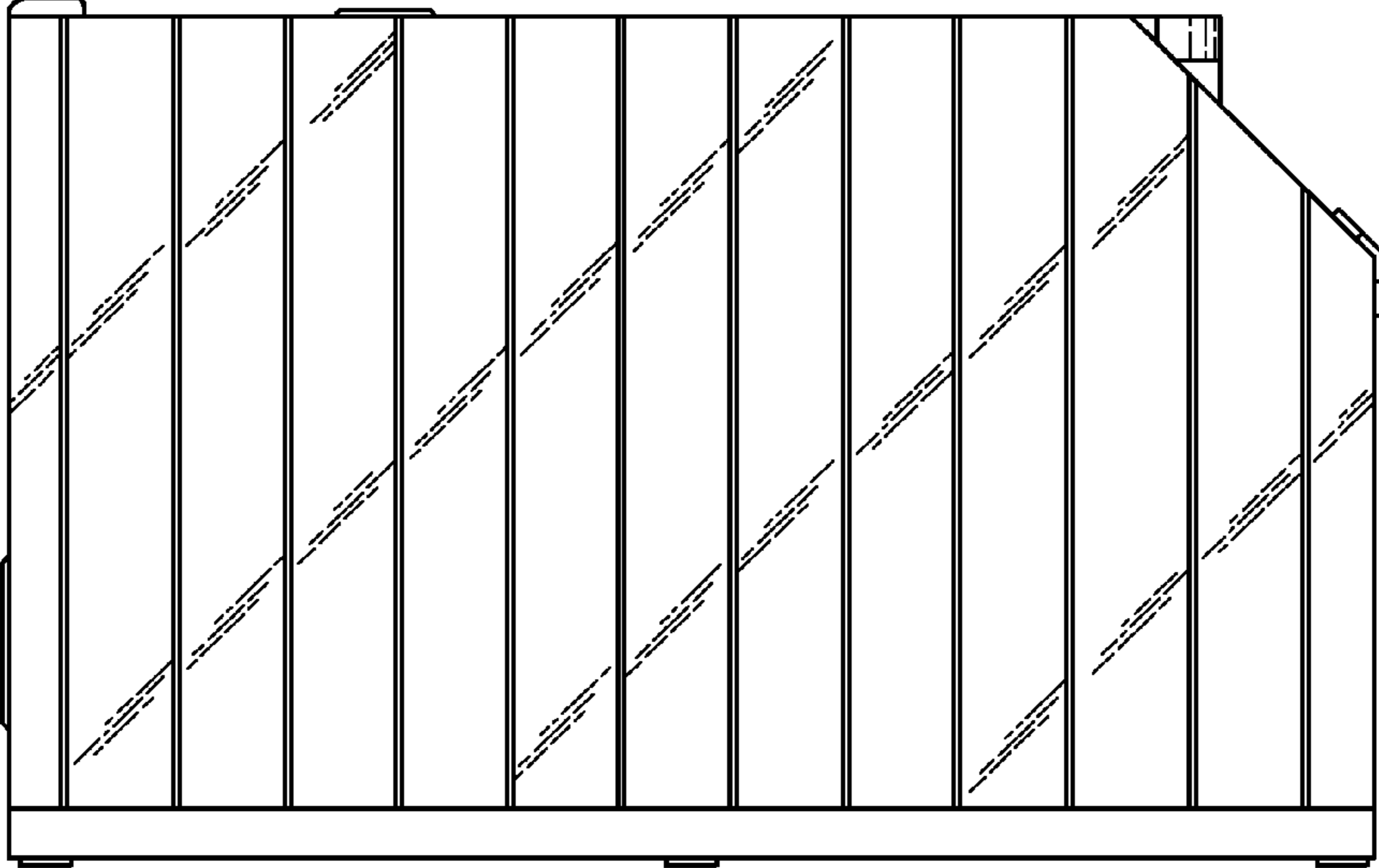

FIG. 5

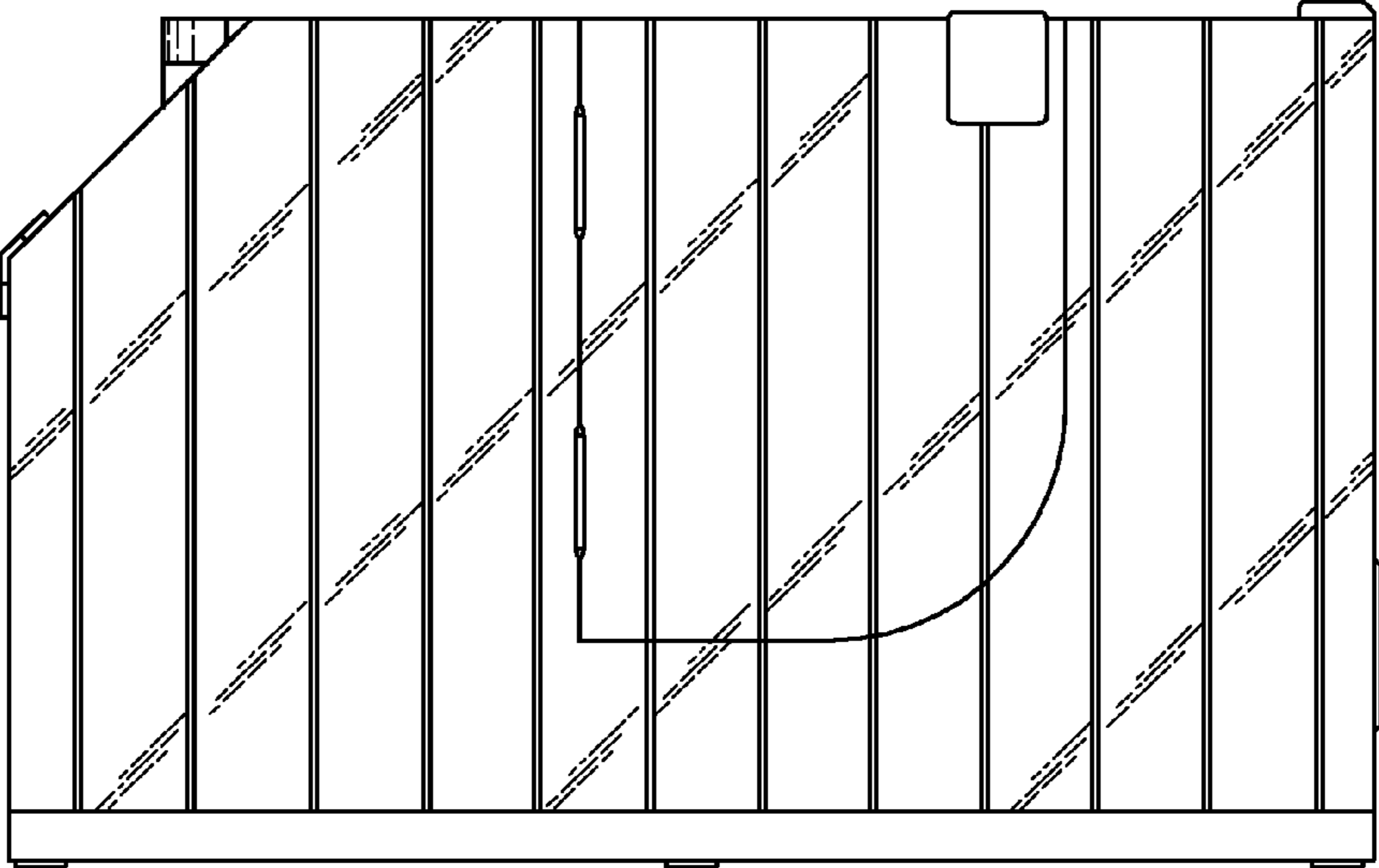

FIG. 6

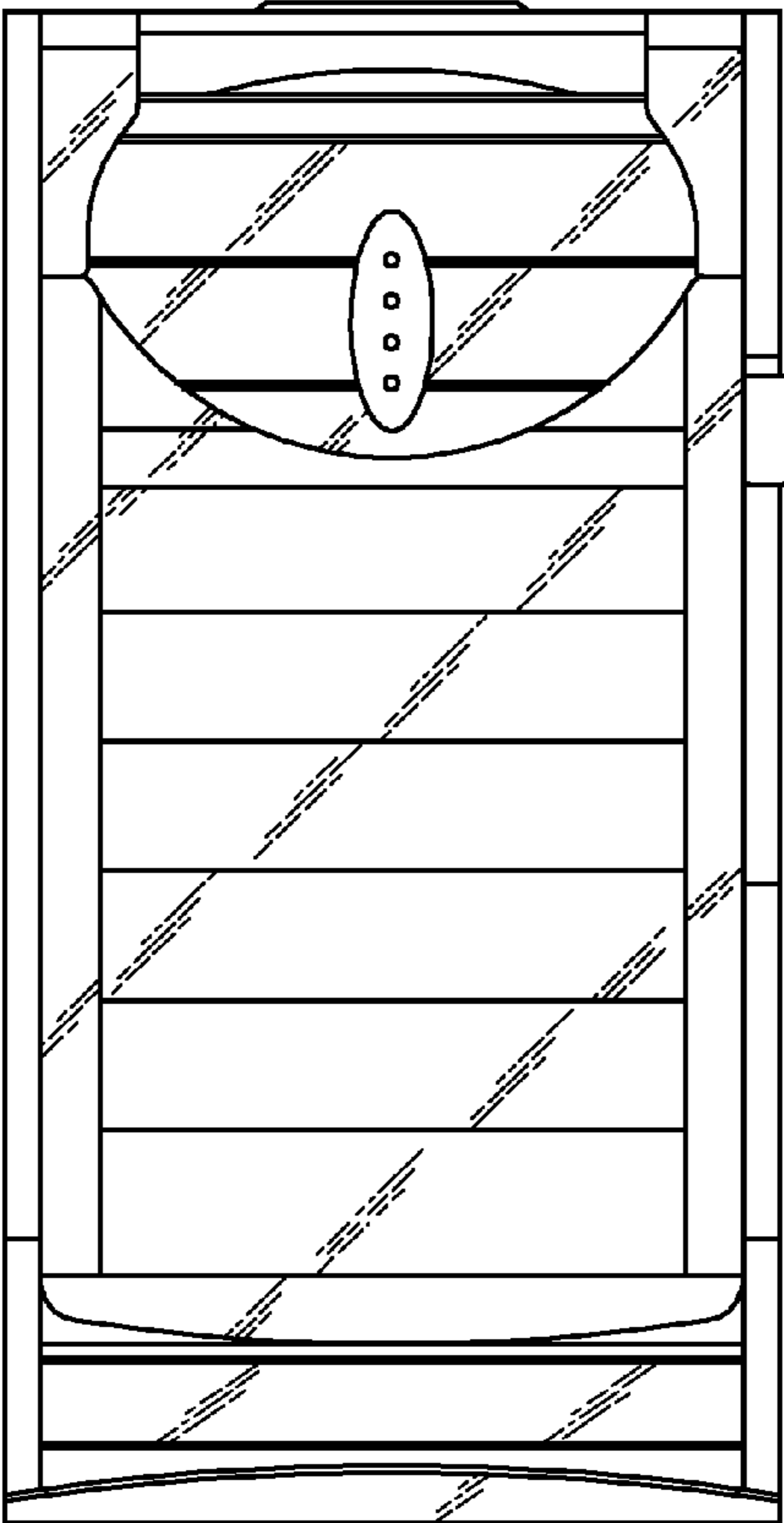

FIG. 7

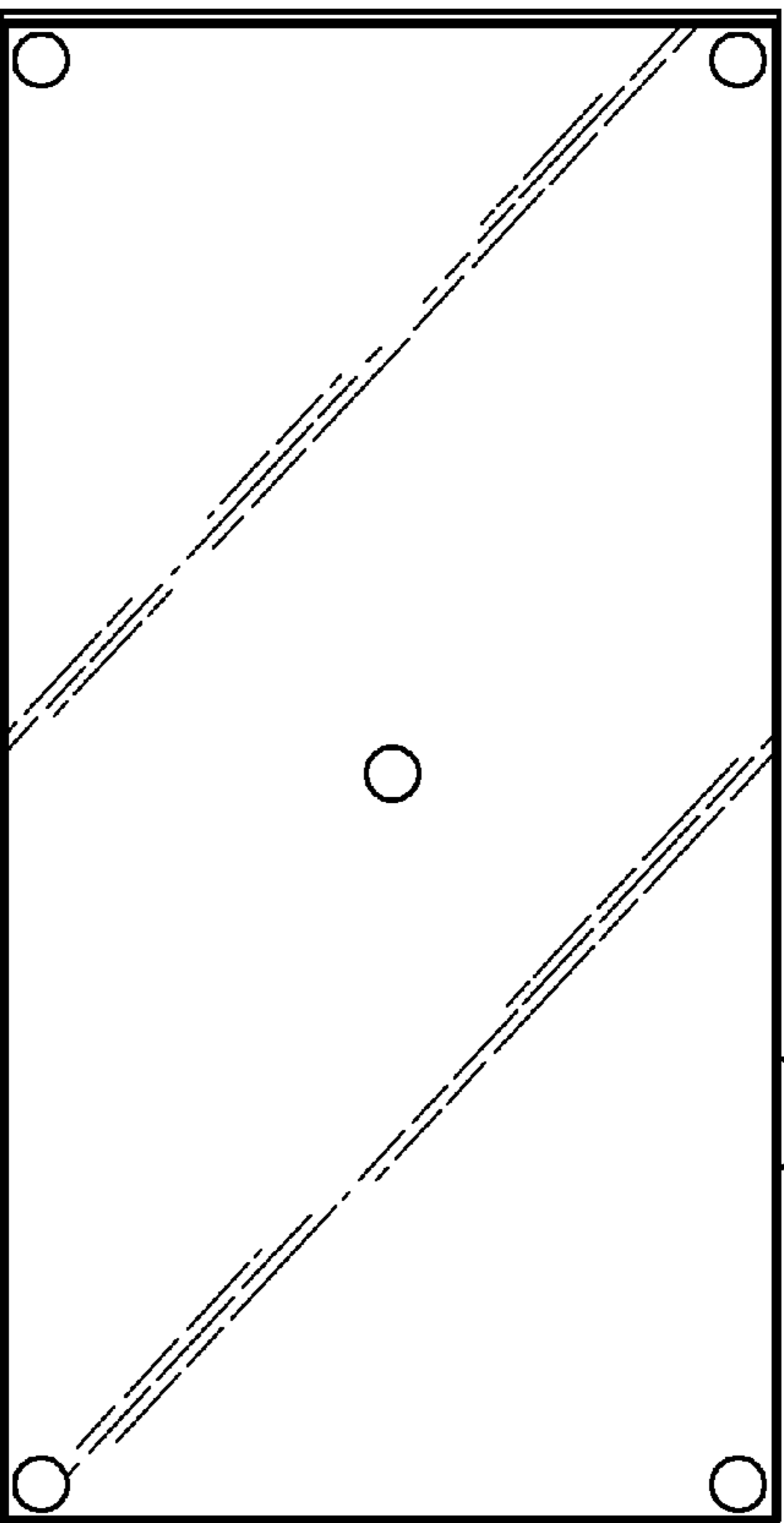

FIG. 8

