

US00D732163S

(12) **United States Design Patent**
Rynerson et al.

(10) **Patent No.:** **US D732,163 S**
(45) **Date of Patent:** **** Jun. 16, 2015**

(54) **INSTRUMENT FOR TREATING AN OCULAR DISORDER**

FOREIGN PATENT DOCUMENTS

(71) Applicant: **RySurg, LLC**, Milford, MI (US)

CN 201692153 U 1/2011
JP 10108801 A 4/1998

(Continued)

(72) Inventors: **James M. Rynerson**, Alvaton, KY (US);
John R. Choate, Milford, MI (US)

OTHER PUBLICATIONS

(73) Assignee: **Blephex, LLC**, Lake Worth, FL (US)

The Alger Company, Inc. "AlgerBrush II," available at http://www.algercompany.com/download/ab_web/Alberbrush3_8.pdf, accessed on Mar. 30, 2012, 1 page.

(**) Term: **14 Years**

(Continued)

(21) Appl. No.: **29/461,500**

(22) Filed: **Jul. 24, 2013**

Primary Examiner — Ian Simmons

Assistant Examiner — Samantha Q Lawrence

(51) **LOC (10) Cl.** **24-02**

(74) *Attorney, Agent, or Firm* — Wood Herron & Evans, LLP

(52) **U.S. Cl.**

USPC **D24/119**

(58) **Field of Classification Search**

USPC D24/110.6, 112–118, 120, 127, 130,
D24/131, 121, 119, 152; 606/107, 162

See application file for complete search history.

(57) **CLAIM**

The ornamental design for an instrument for treating an ocular disorder, as shown and described.

(56) **References Cited**

DESCRIPTION

U.S. PATENT DOCUMENTS

D262,739 S *	1/1982	Nitshke	D24/130
D286,438 S *	10/1986	Lichtman et al.	D24/133
4,778,457 A	10/1988	York		
4,838,851 A	6/1989	Shabo		
D306,347 S *	2/1990	Gyurik	D24/119
4,955,896 A	9/1990	Freeman		
5,632,756 A *	5/1997	Kruglick	606/162
5,690,618 A *	11/1997	Smith et al.	604/232
D401,332 S *	11/1998	Picha et al.	D24/129
6,116,900 A *	9/2000	Ostler	433/89
D588,697 S *	3/2009	Hickok	D24/152
D589,620 S *	3/2009	Hickok	D24/152
D645,140 S *	9/2011	Peuker et al.	D24/114
D701,304 S *	3/2014	Lair et al.	D24/129
D701,308 S *	3/2014	Brannon	D24/152
D705,426 S *	5/2014	Fiorina et al.	D24/152
2006/0116355 A1	6/2006	Van Breen		

(Continued)

FIG. 1 is a top perspective view of an instrument for treating an ocular disorder according to the present invention.

FIG. 2 is a bottom perspective view of the instrument for treating an ocular disorder of FIG. 1.

FIG. 3 is a front view of the instrument for treating an ocular disorder of FIG. 1, the rear view being identical thereof.

FIG. 4 is a right side view of the instrument for treating an ocular disorder of FIG. 1, the left side view being identical thereof.

FIG. 5 is a bottom view of the instrument for treating an ocular disorder of FIG. 1; and,

FIG. 6 is a top view of the instrument for treating an ocular disorder of FIG. 1.

The broken lines shown in FIGS. 1-6 illustrate the environment of the claimed design and forms no part thereof.

1 Claim, 2 Drawing Sheets

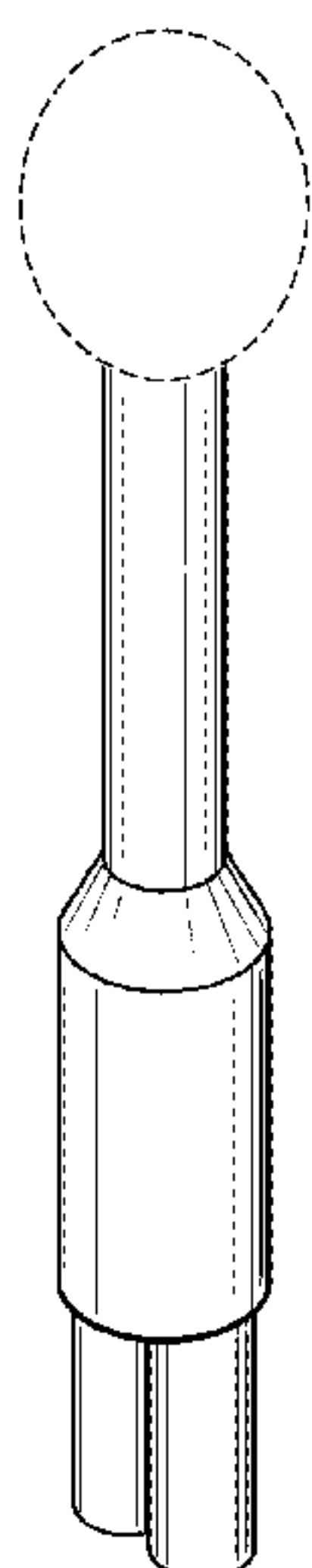

(56)

References Cited

U.S. PATENT DOCUMENTS

2007/0231353 A1 10/2007 Gilbard et al.
2008/0188877 A1* 8/2008 Hickingbotham 606/162
2009/0112242 A1* 4/2009 Kao 606/162
2011/0144562 A1* 6/2011 Heeren et al. 604/20
2014/0031845 A1* 1/2014 Rynerson 606/162
2014/0052164 A1* 2/2014 Rynerson 606/162
2014/0214062 A1* 7/2014 Rynerson et al. 606/162

FOREIGN PATENT DOCUMENTS

WO 9633676 A1 10/1996
WO 2012092320 A2 7/2012
WO 2012092320 A3 7/2012

OTHER PUBLICATIONS

1Forthemoney, et al. "Blepharitis," available at <http://en.wikipedia.org/w/index.php?oldid=474399644>, accessed on Mar. 12, 2012, 6 pp.
International Searching Authority, International Search Report and Written Opinion, International Application No. PCT/US2013/051850, mailed Oct. 14, 2013, 11 pp.

* cited by examiner

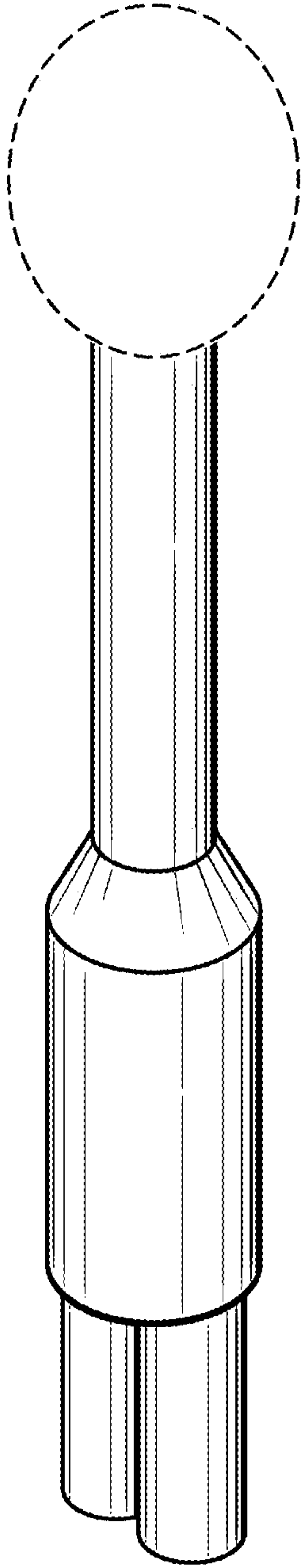

FIG. 1

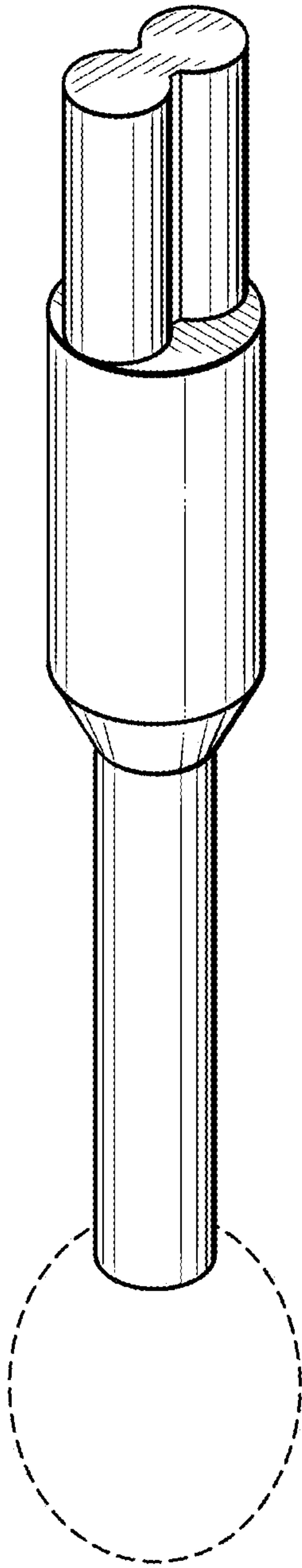

FIG. 2

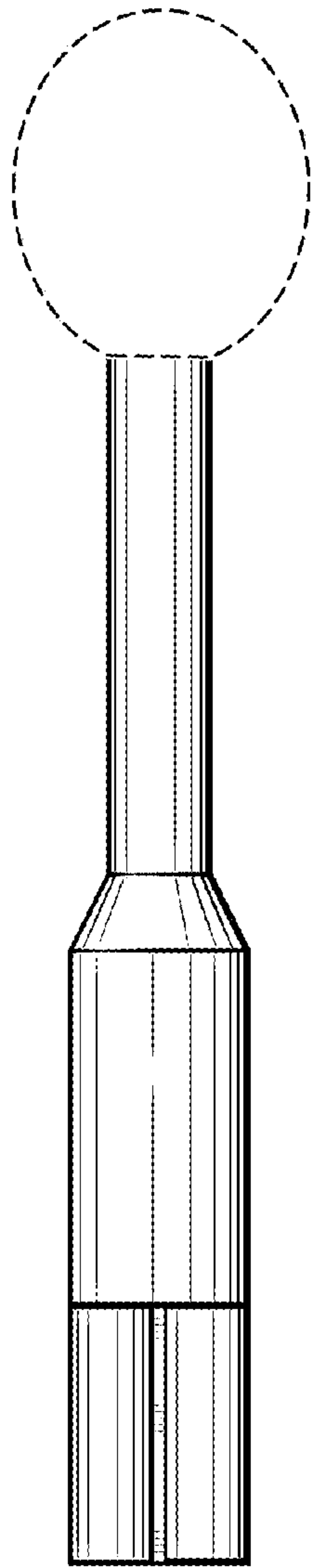

FIG. 3

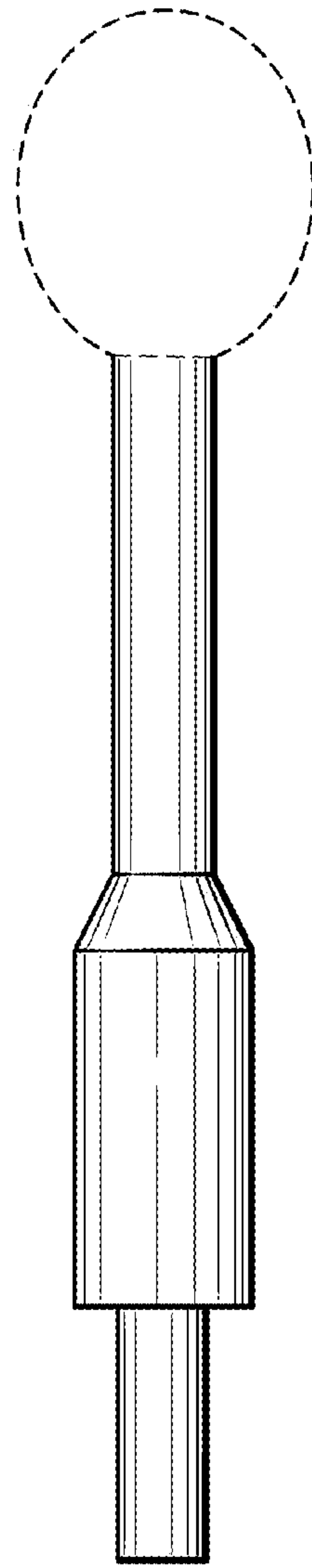

FIG. 4

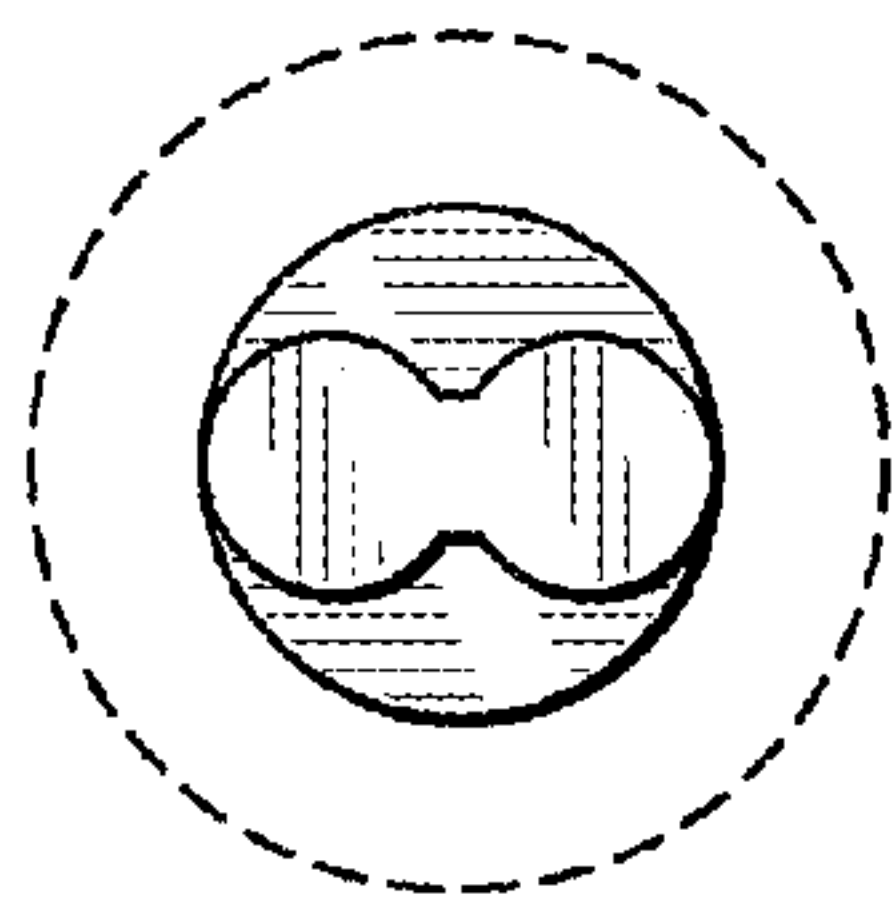

FIG. 5

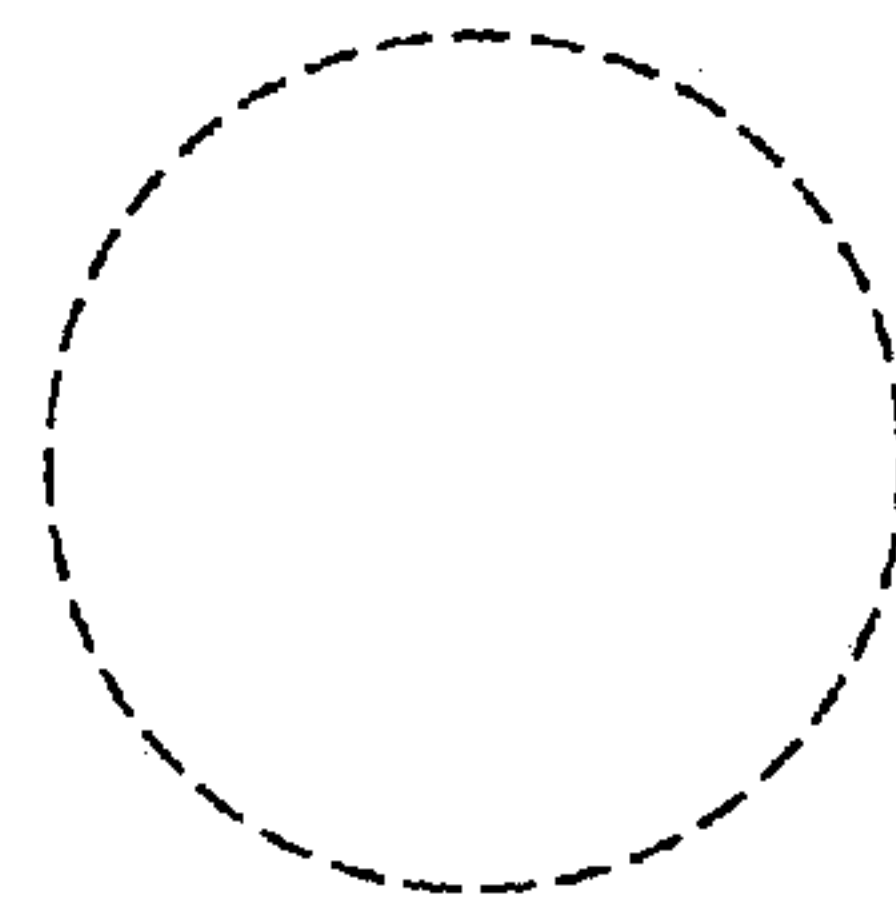

FIG. 6