

US00D732126S

(12) **United States Design Patent**
Dolezel et al.

(10) **Patent No.:** **US D732,126 S**
(45) **Date of Patent:** **** Jun. 16, 2015**

(54) **GOLF CLUB HEAD**
(71) Applicant: **DUNLOP SPORTS CO. LTD.**,
Kobe-shi, Hyogo (JP)
(72) Inventors: **Keith Dolezel**, West Covina, CA (US);
Nick Trahan, Huntington Beach, CA
(US); **Phillip Seagram**, Long Beach, CA
(US); **Mika Becktor**, Costa Mesa, CA
(US)

(73) Assignee: **DUNLOP SPORTS CO. LTD.**,
Kobe-shi (JP)

(**) Term: **14 Years**

(21) Appl. No.: **29/494,493**

(22) Filed: **Jun. 20, 2014**

(51) **LOC (10) Cl.** **21-02**

(52) **U.S. Cl.**
USPC **D21/759**

(58) **Field of Classification Search**
USPC D21/747-751, 759
CPC A63B 53/00; A63B 53/04; A63B 53/047;
A63B 53/0475
See application file for complete search history.

(56) **References Cited**

U.S. PATENT DOCUMENTS

| | | | | |
|----------------|---------|--------------------|-------|---------|
| D209,299 S * | 11/1967 | Long | | D21/751 |
| D337,143 S * | 7/1993 | Lo | | D21/750 |
| D412,545 S * | 8/1999 | Best et al. | | D21/759 |
| D435,277 S * | 12/2000 | Erickson et al. | | D21/747 |
| 6,210,290 B1 * | 4/2001 | Erickson et al. | | 473/345 |
| D453,949 S * | 2/2002 | Helmstetter et al. | | D21/747 |
| D454,606 S * | 3/2002 | Helmstetter et al. | | D21/747 |
| D491,620 S * | 6/2004 | Nishitani | | D21/747 |
| D518,538 S * | 4/2006 | Ines et al. | | D21/747 |

| | | | | |
|--------------|--------|------------------|-------|---------|
| D534,595 S * | 1/2007 | Hasebe | | D21/747 |
| D572,781 S * | 7/2008 | Kim et al. | | D21/747 |
| D614,710 S * | 4/2010 | Kim et al. | | D21/747 |
| D643,895 S * | 8/2011 | Wieland | | D21/747 |
| D674,852 S * | 1/2013 | Hettinger et al. | | D21/748 |
| D682,960 S * | 5/2013 | Voshall et al. | | D21/747 |
| D682,962 S * | 5/2013 | Llewellyn et al. | | D21/747 |
| D685,042 S * | 6/2013 | Jertson et al. | | D21/759 |
| D704,290 S * | 5/2014 | Cardani et al. | | D21/759 |
| D707,772 S * | 6/2014 | Oldknow | | D21/759 |

* cited by examiner

Primary Examiner — Mitchell Siegel

(74) *Attorney, Agent, or Firm* — Oliff PLC

(57) **CLAIM**

The ornamental design for a golf club head, as shown and described.

DESCRIPTION

FIG. 1 is a front elevational view of the golf club head;
FIG. 2 is a rear elevational view thereof;
FIG. 3 is toe-side elevational view thereof;
FIG. 4 is a heel-side elevational view thereof;
FIG. 5 is a top plan view thereof;
FIG. 6 is a bottom plan view thereof;
FIG. 7 is a front, toe-side, top perspective view thereof;
FIG. 8 is a front, heel-side, top perspective view thereof;
FIG. 9 is rear, toe-side, top perspective view thereof;
FIG. 10 is rear, heel-side, top perspective view thereof;
FIG. 11 is rear, heel-side, bottom perspective view thereof;
FIG. 12 is a rear, toe-side, bottom perspective view thereof;
and,
FIG. 13 is a cross-sectional view taken along line 13-13 in FIG. 2.

The broken lines depict environmental subject matter and form no part of the claimed design.

1 Claim, 11 Drawing Sheets



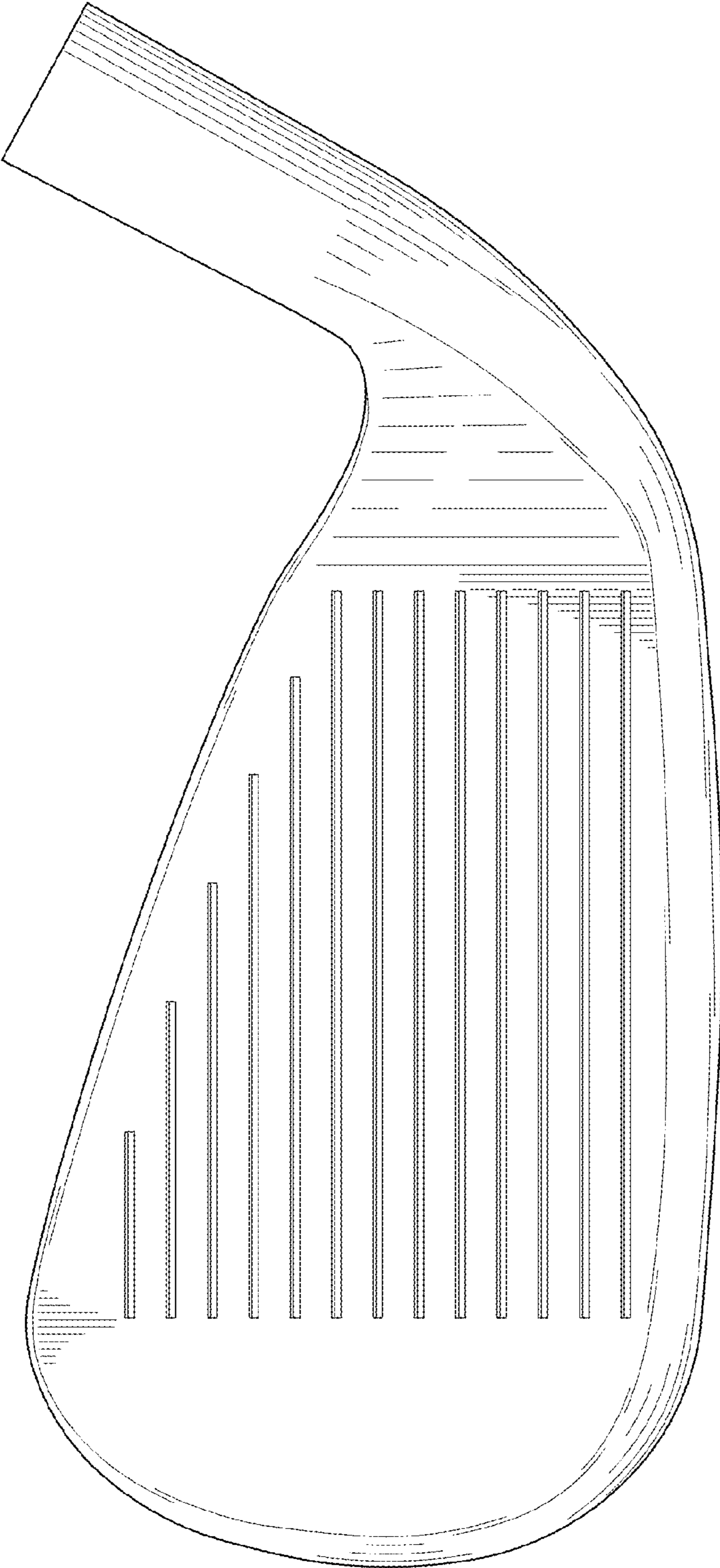

FIG. 1

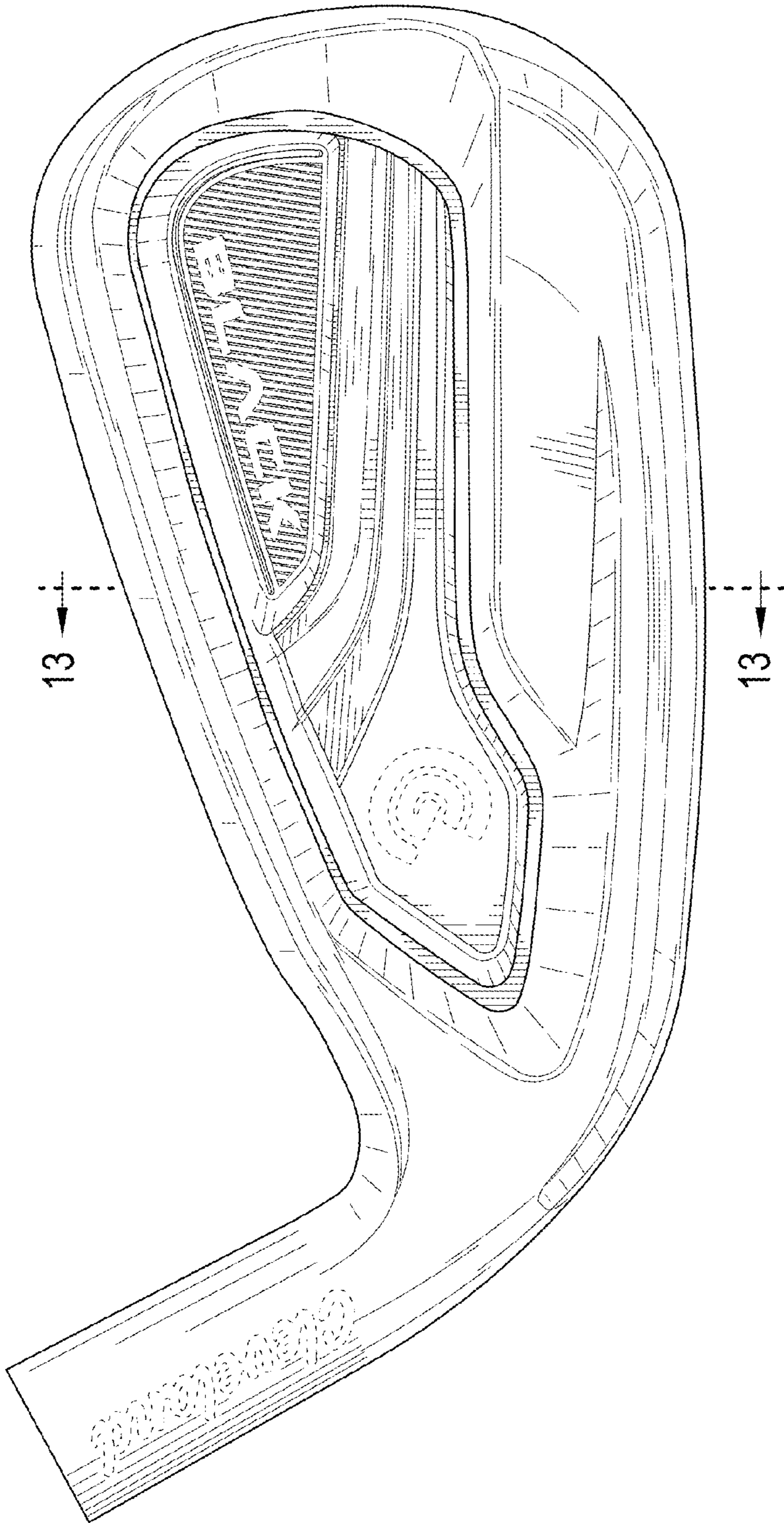

FIG. 2

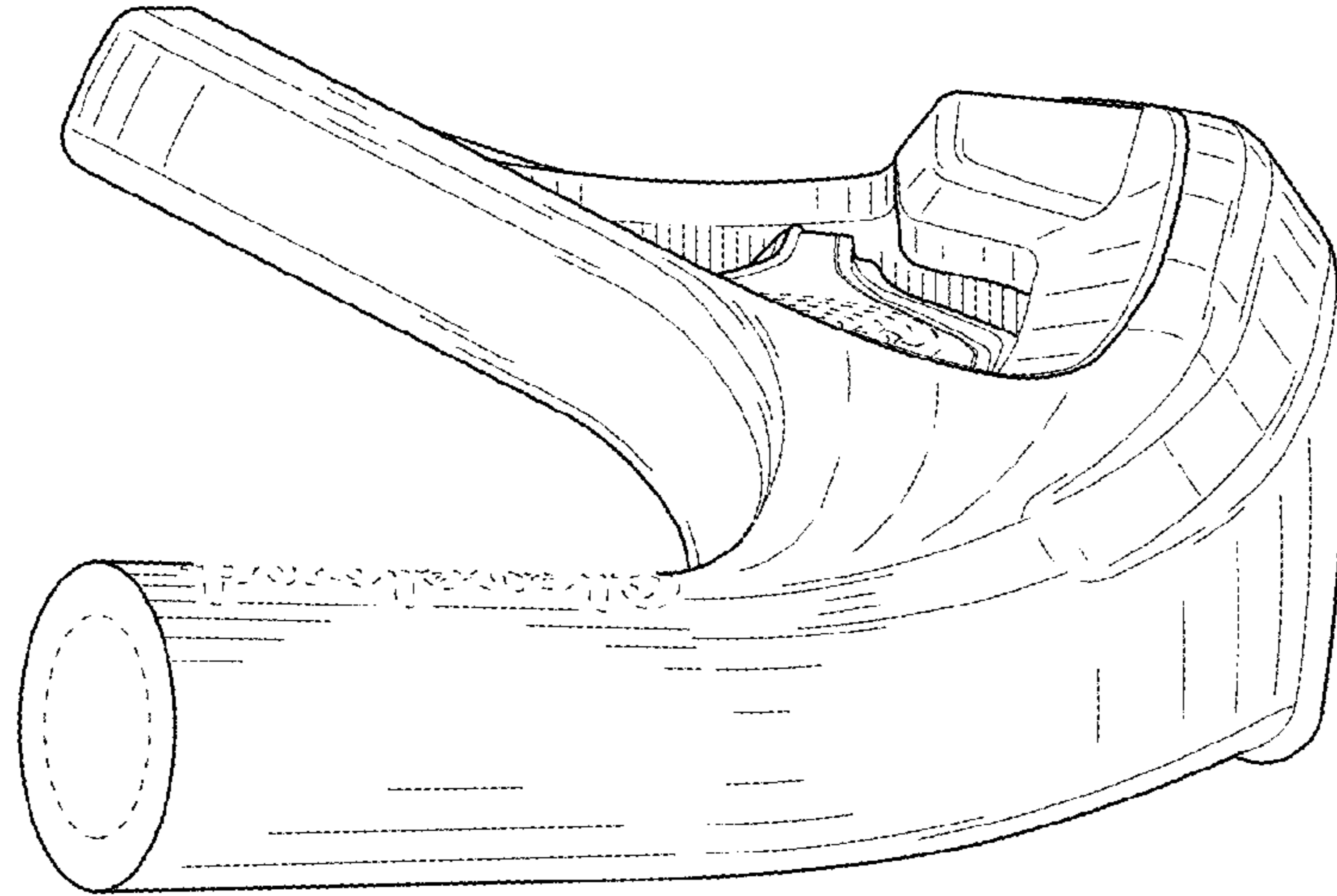

FIG. 4

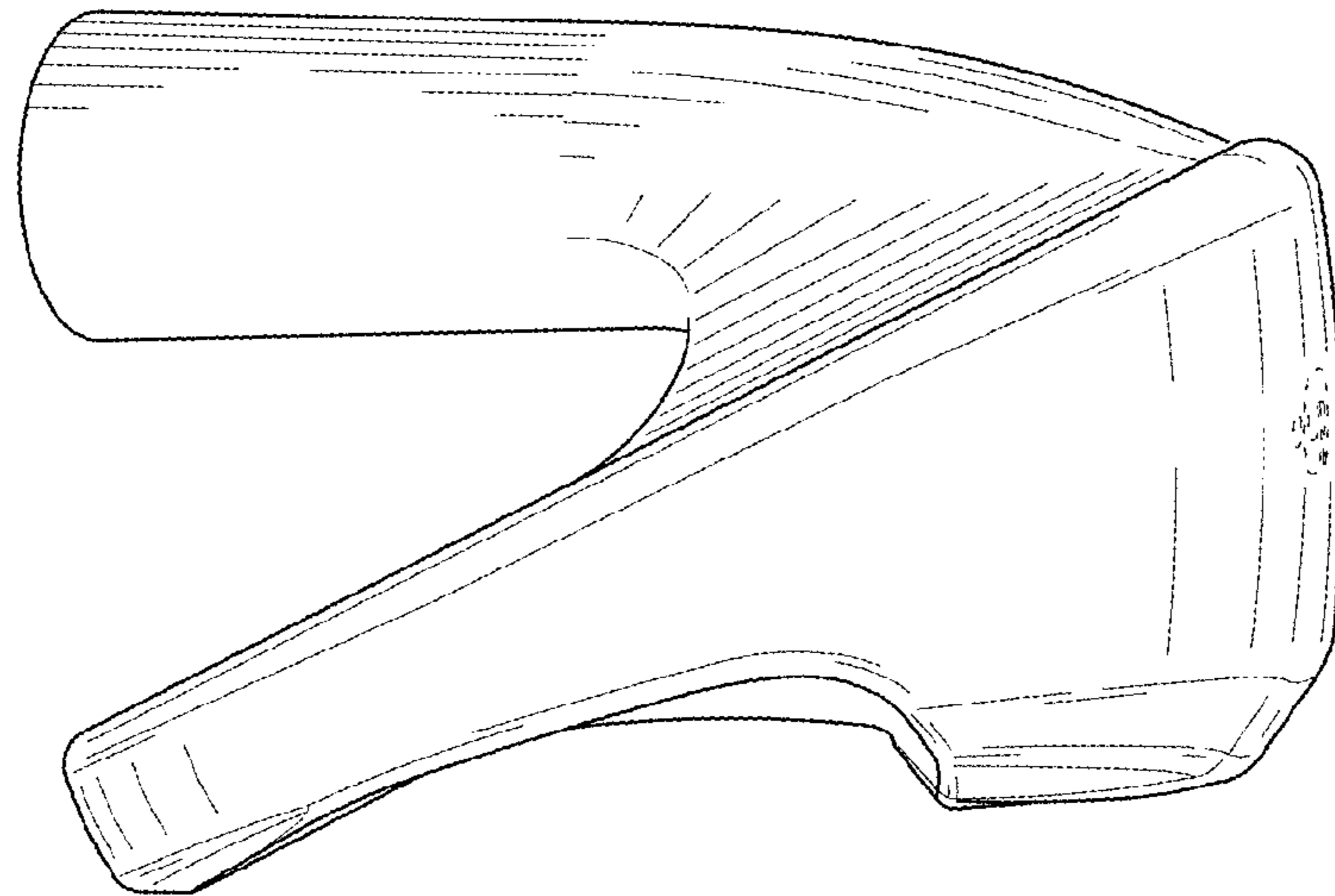

FIG. 3

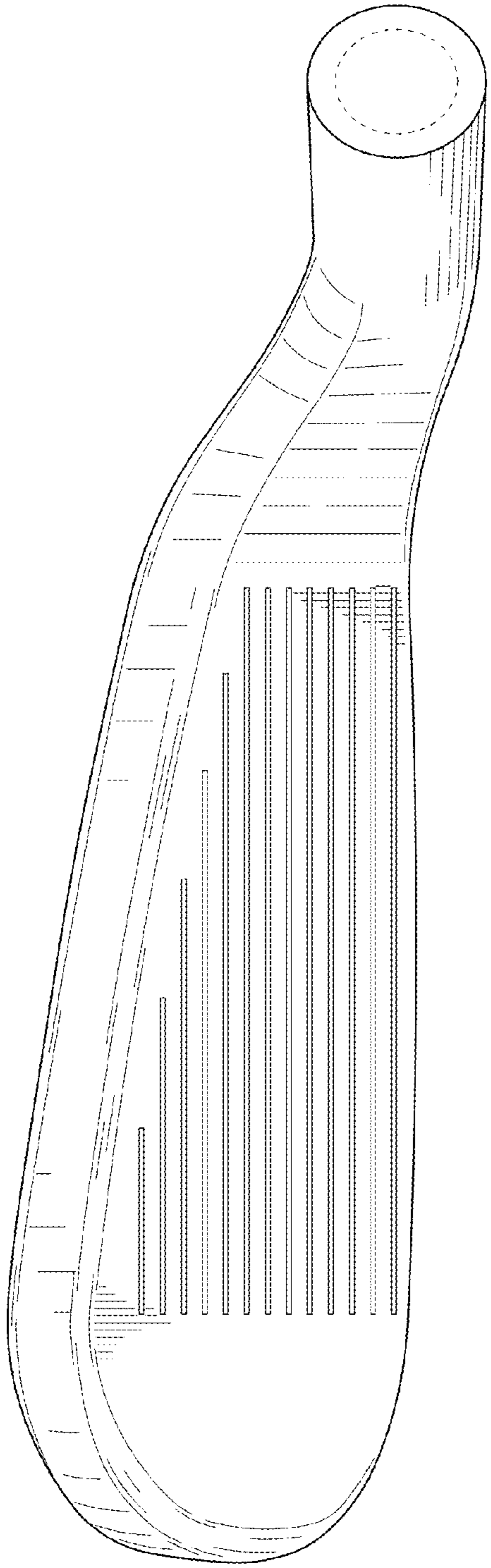

FIG. 5

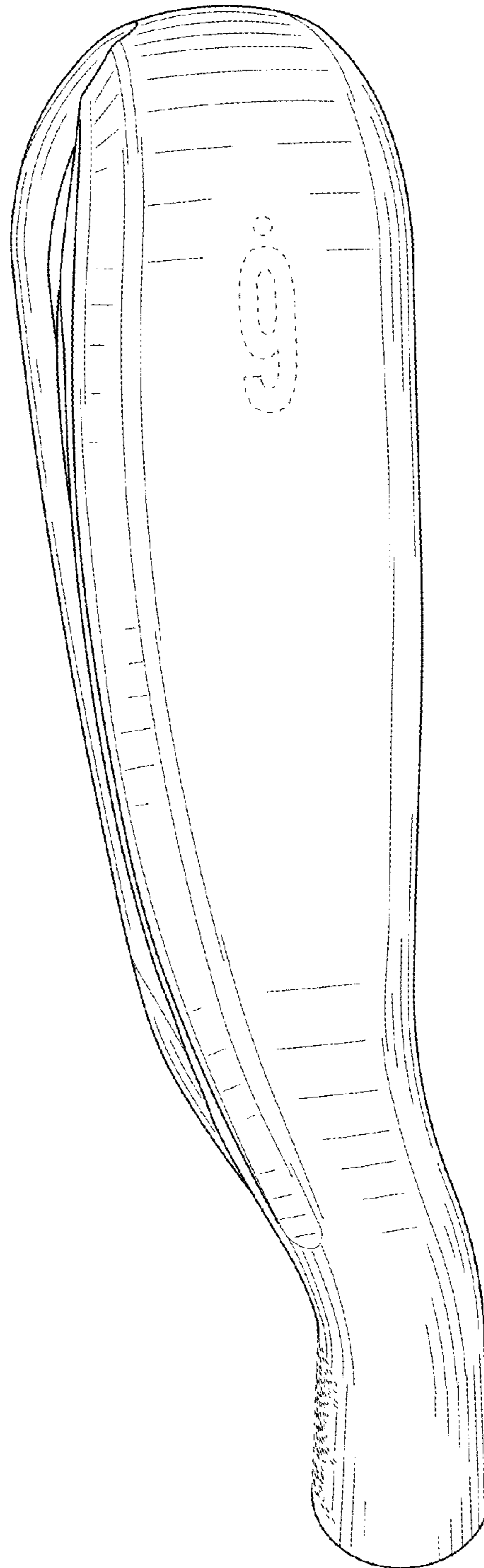

FIG. 6

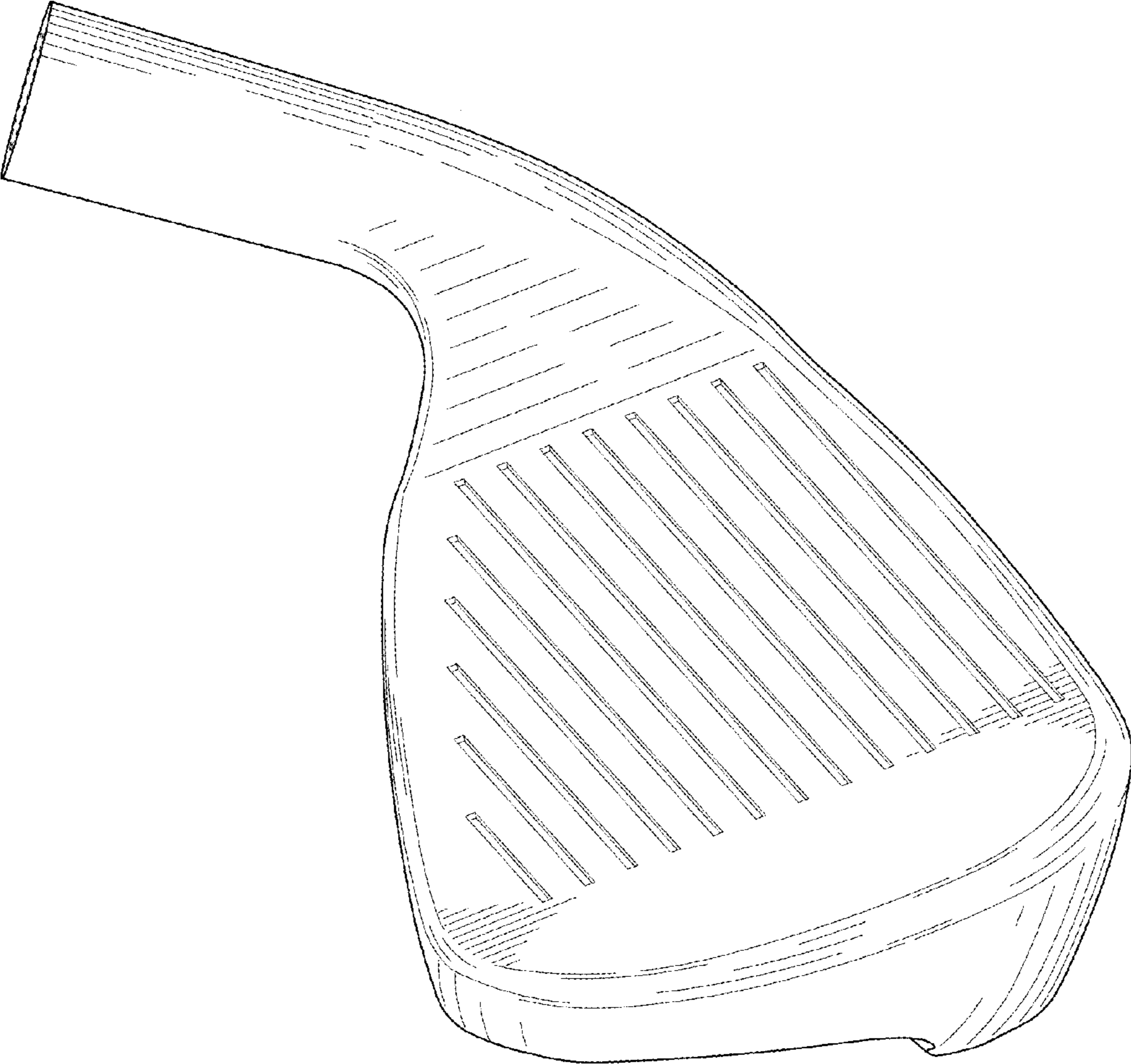

FIG. 7

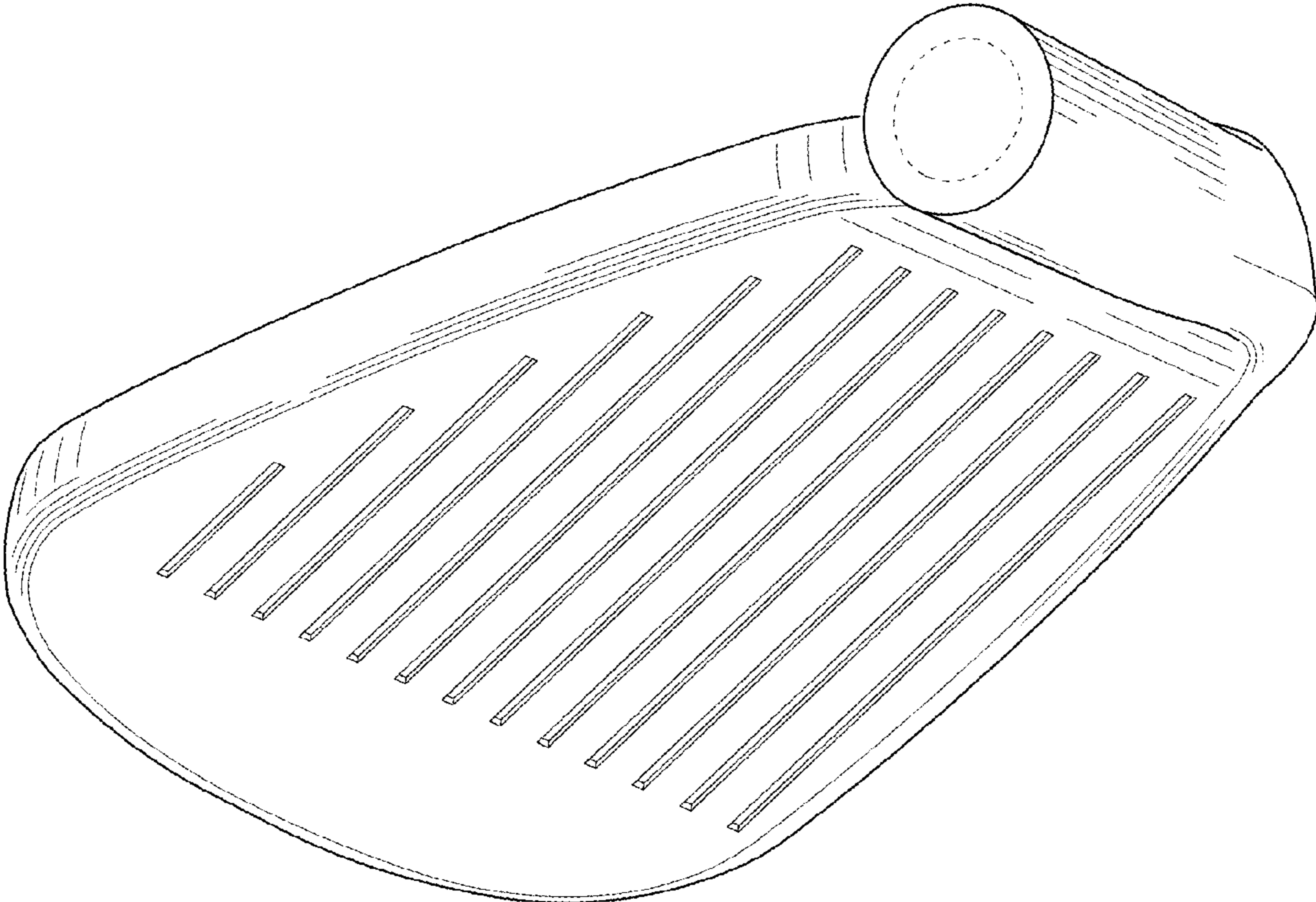

FIG. 8

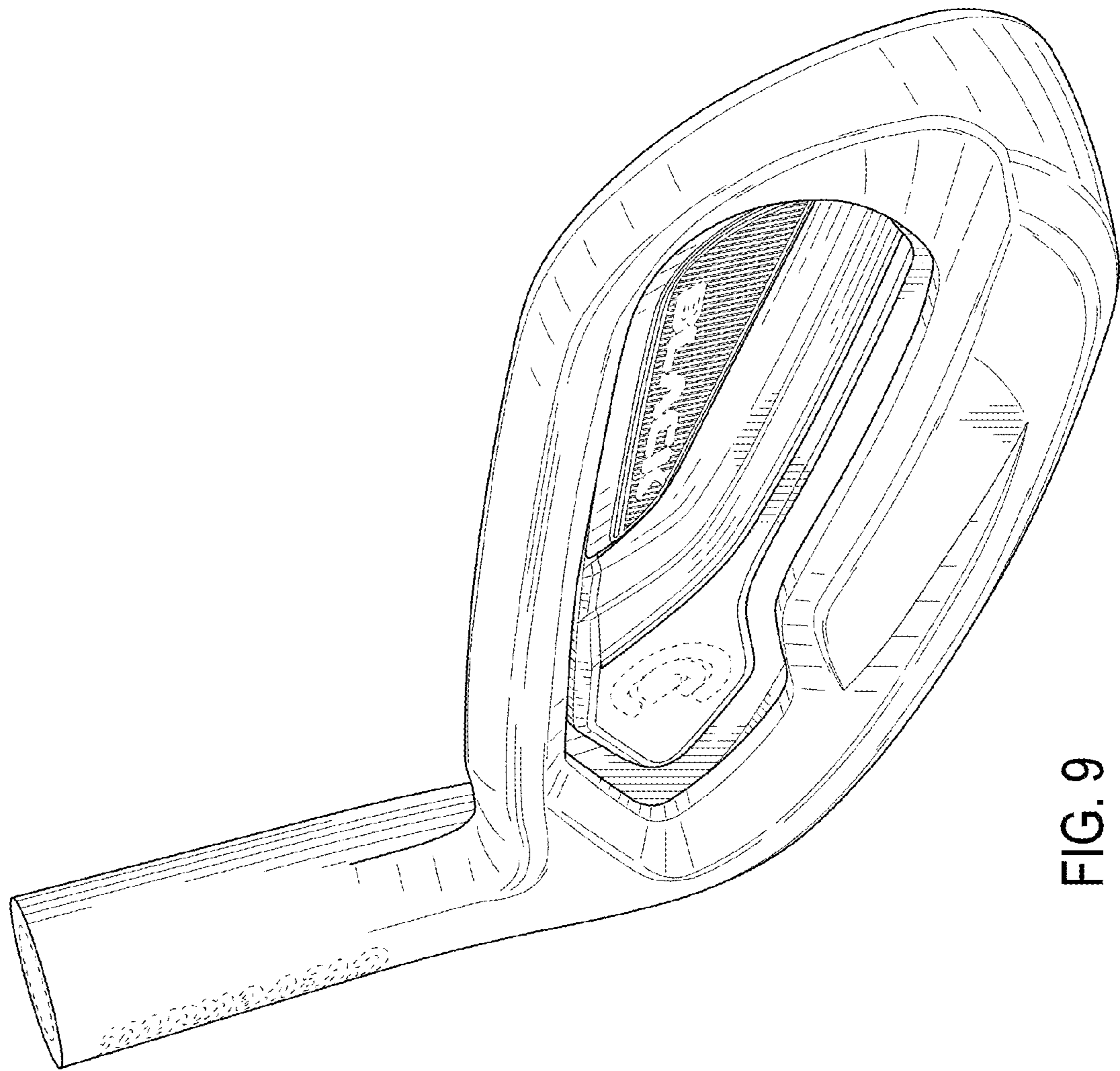

FIG. 9

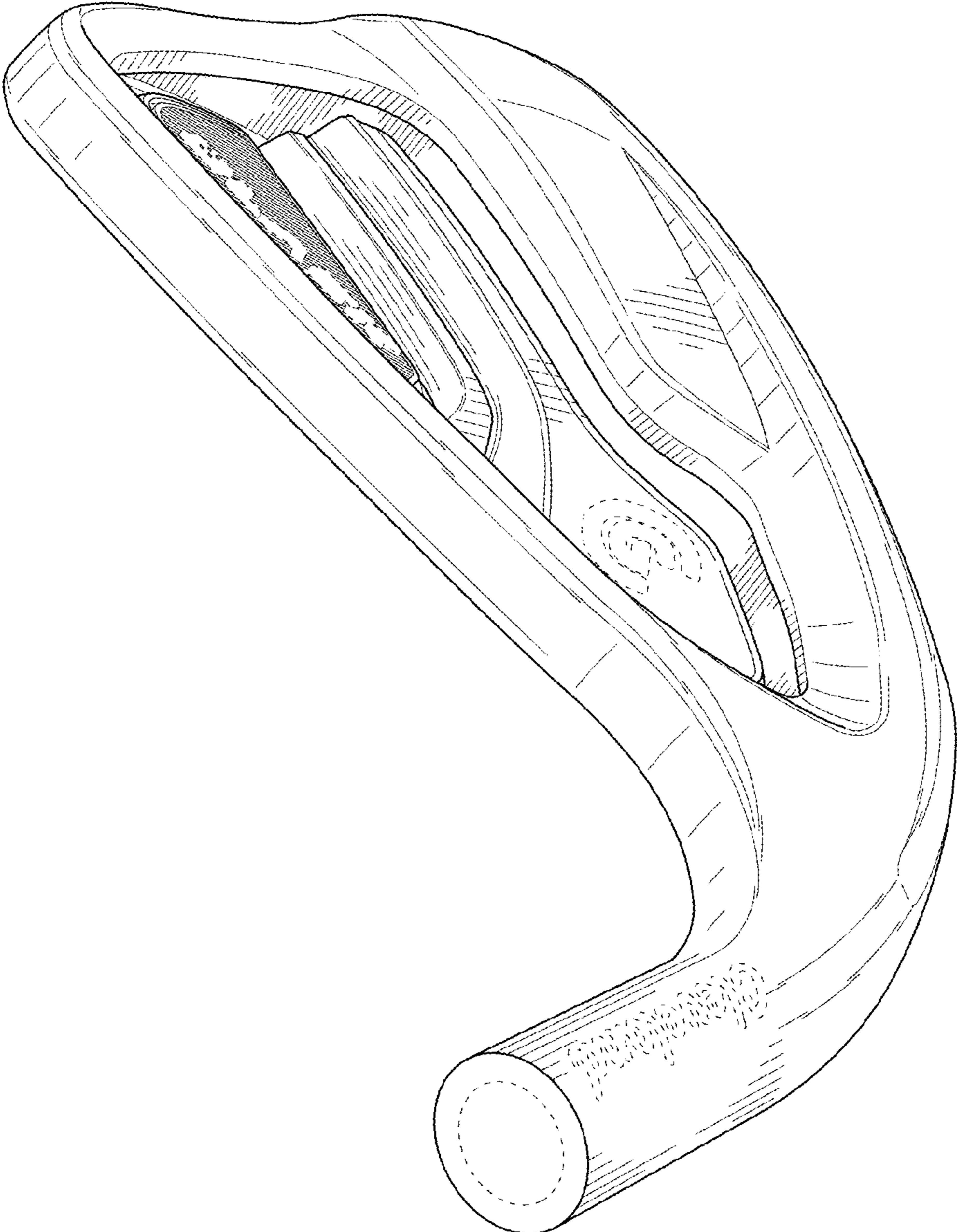

FIG. 10

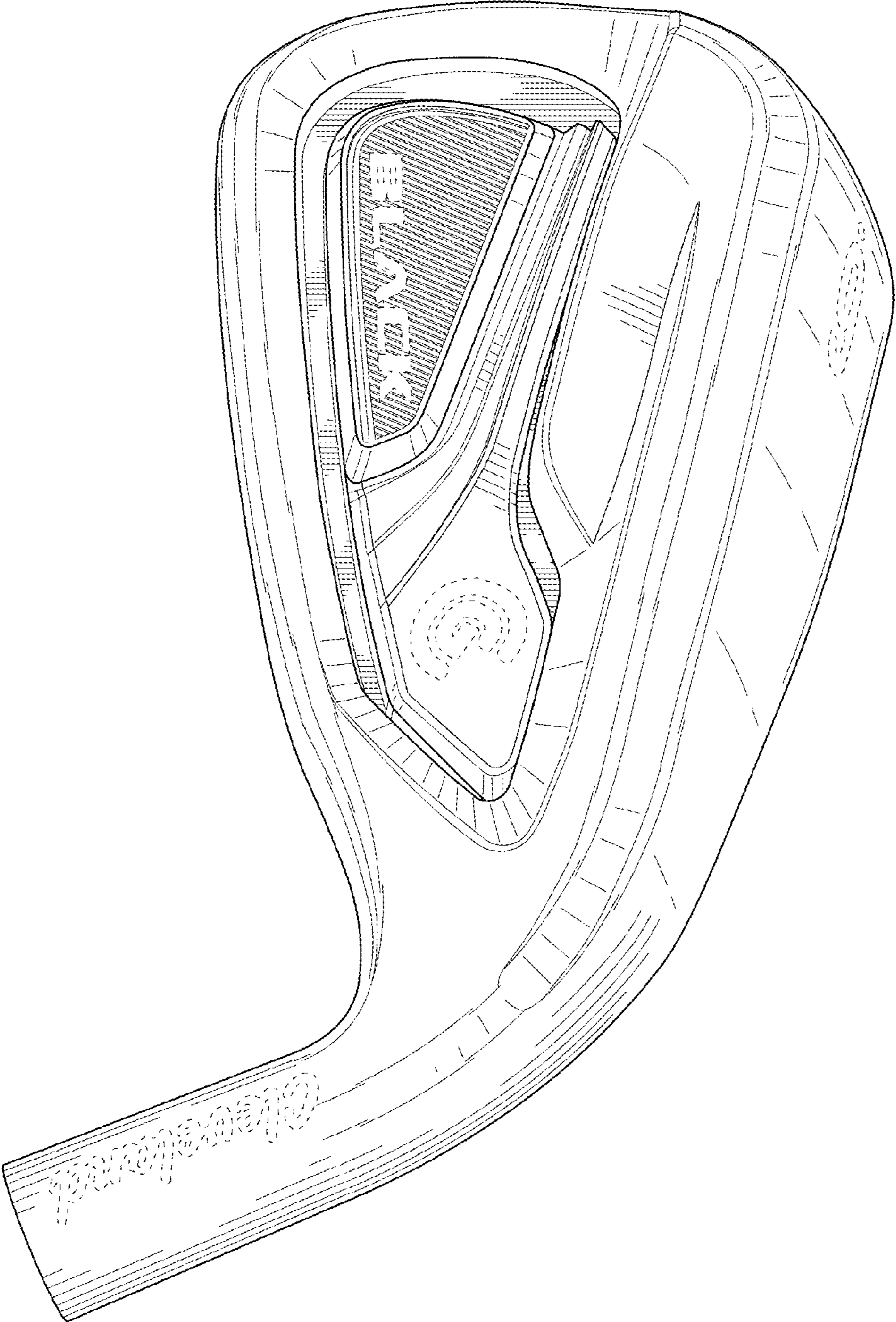

FIG. 11

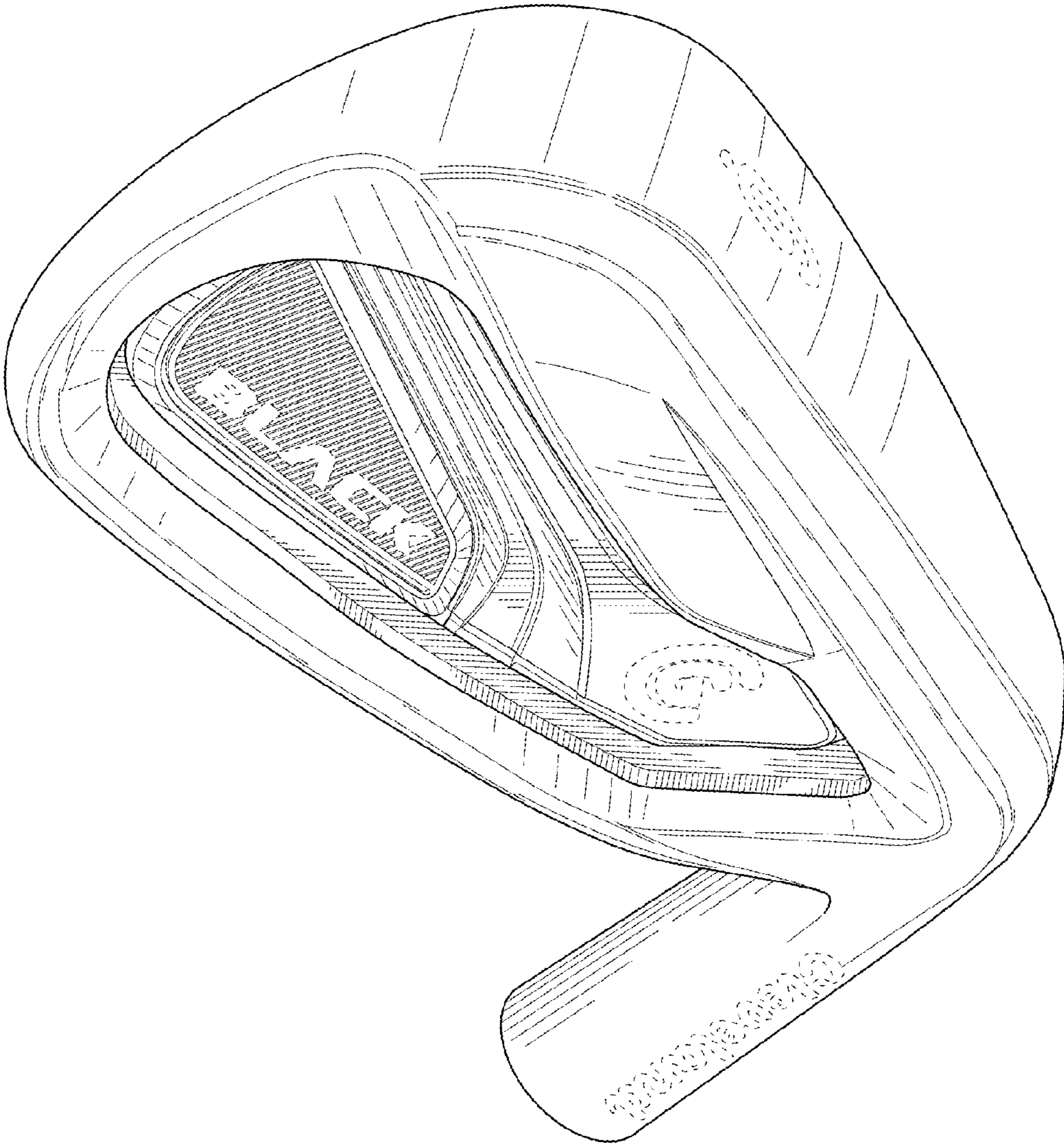

FIG. 12

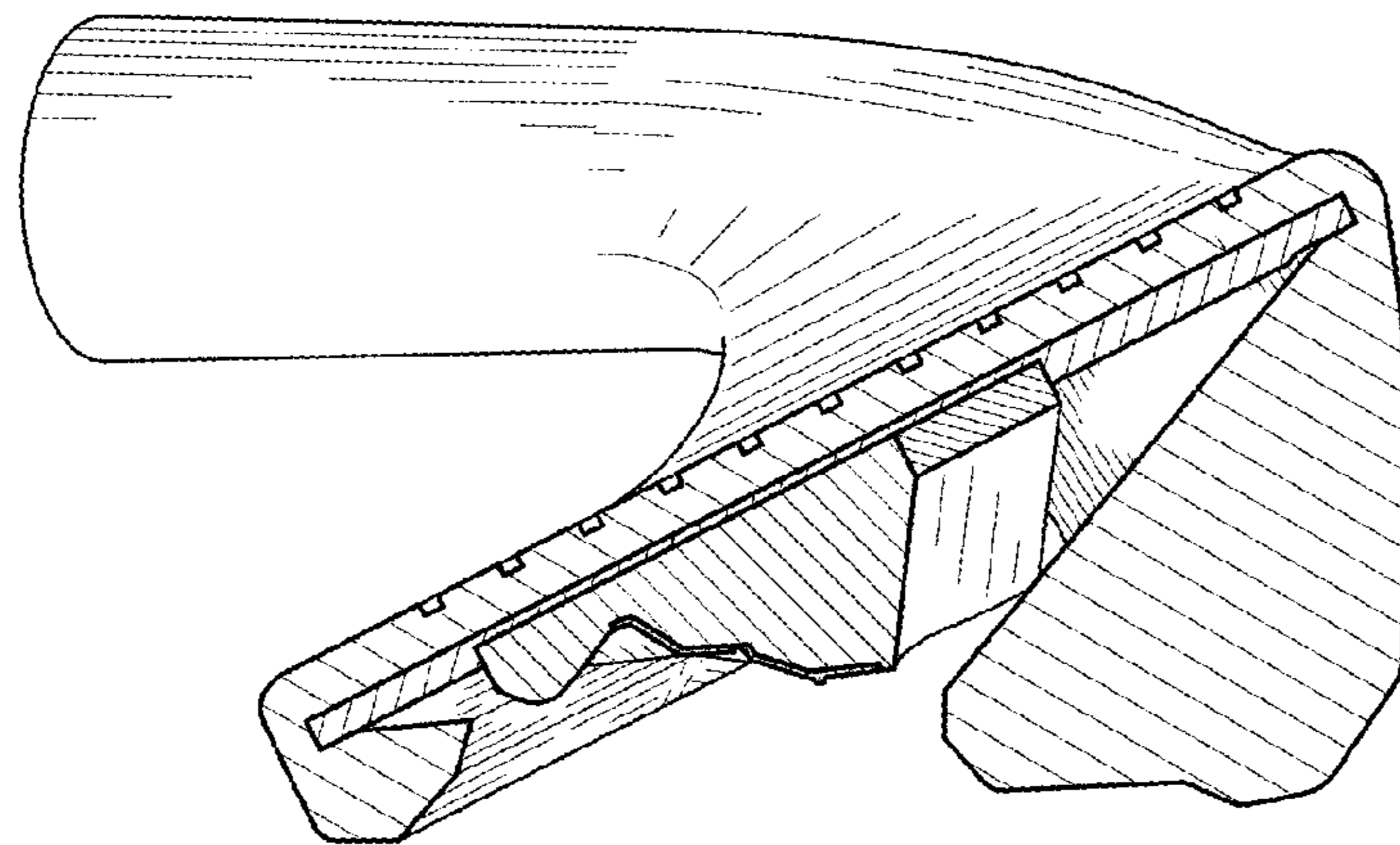

FIG. 13