



US00D732017S

(12) **United States Design Patent**
Yun

(10) **Patent No.:** **US D732,017 S**
(45) **Date of Patent:** **** Jun. 16, 2015**

(54) **TABLET COMPUTER**

(71) Applicant: **Samsung Electronics Co., Ltd.**,
Suwon-si (KR)
(72) Inventor: **Yeo-Wan Yun**, Sungnam-Si (KR)
(73) Assignee: **Samsung Electronics Co., Ltd.**,
Suwon-si (KR)
(**) Term: **14 Years**

(21) Appl. No.: **29/453,621**
(22) Filed: **May 1, 2013**

(30) **Foreign Application Priority Data**
Nov. 2, 2012 (KR) 30-2012-0052461

(51) **LOC (10) Cl.** **14-02**
(52) **U.S. Cl.**
USPC **D14/341**

(58) **Field of Classification Search**
USPC D14/341-347, 137, 138 R, 138 AA,
D14/138 C, 138 G, 496, 203.1, 203.3, 203.4,
D14/203.7, 129, 130, 147, 248, 250, 374,
D14/385, 388, 389, 315-318, 439, 126, 336,
D14/339, 340; D10/65, 104.1; D21/324,
D21/329, 330, 332; 455/556.1, 556.2, 566,
455/575.1, 90.3; 379/433.04, 433.01,
379/433.06, 916; 345/173; 361/679.26,
361/679.27, 679.3, 679.55, 679.56,
361/680-686; D6/310; 463/37;
248/917-924; 348/373, 376; D19/26
CPC A63H 33/3016; G06F 1/1613; H04M
1/0202; H04M 1/0279; H04M 1/0281; H04M
1/0283

See application file for complete search history.

(56) **References Cited**

U.S. PATENT DOCUMENTS

D547,283	S	*	7/2007	Hsiung	D14/129
D622,273	S	*	8/2010	Hayton et al.	D14/439
D645,465	S	*	9/2011	Lin et al.	D14/341
D656,935	S	*	4/2012	Jones et al.	D14/341
D664,776	S	*	8/2012	Pitts Brown	D6/310
D664,955	S	*	8/2012	Kim et al.	D14/341
D669,470	S	*	10/2012	Zha et al.	D14/341
D671,938	S	*	12/2012	Hsu et al.	D14/341
D673,561	S	*	1/2013	Hyun et al.	D14/341
D675,614	S	*	2/2013	Feng et al.	D14/341
D677,181	S	*	3/2013	Lenz et al.	D10/65
D678,875	S	*	3/2013	Chen	D14/341
D685,784	S	*	7/2013	Ma	D14/341
D692,877	S	*	11/2013	Zuege	D14/341
D711,371	S	*	8/2014	Chen et al.	D14/341
D714,784	S	*	10/2014	Park	D14/341
2014/0029189	A1	*	1/2014	Change et al.	361/679.11
2014/0153176	A1	*	6/2014	Ashcraft et al.	361/679.21

* cited by examiner

Primary Examiner — Barbara Fox
Assistant Examiner — Dana K Weiland
(74) *Attorney, Agent, or Firm* — NSIP Law

(57) **CLAIM**
The ornamental design for a tablet computer, as shown and described.

DESCRIPTION

FIG. 1 is a front perspective view of a tablet computer, showing my new design;
FIG. 2 is a front view thereof;
FIG. 3 is a rear view thereof;
FIG. 4 is a left-side view thereof;
FIG. 5 is a right-side view thereof;
FIG. 6 is a top plan view thereof;
FIG. 7 is a bottom plan view thereof; and,
FIG. 8 is a rear perspective view thereof, showing a stand and handle extended.
The broken lines shown in the drawings represent portions of the tablet computer that form no part of the claimed design. The shade lines in the figures show contour and not surface ornamentation.

1 Claim, 4 Drawing Sheets

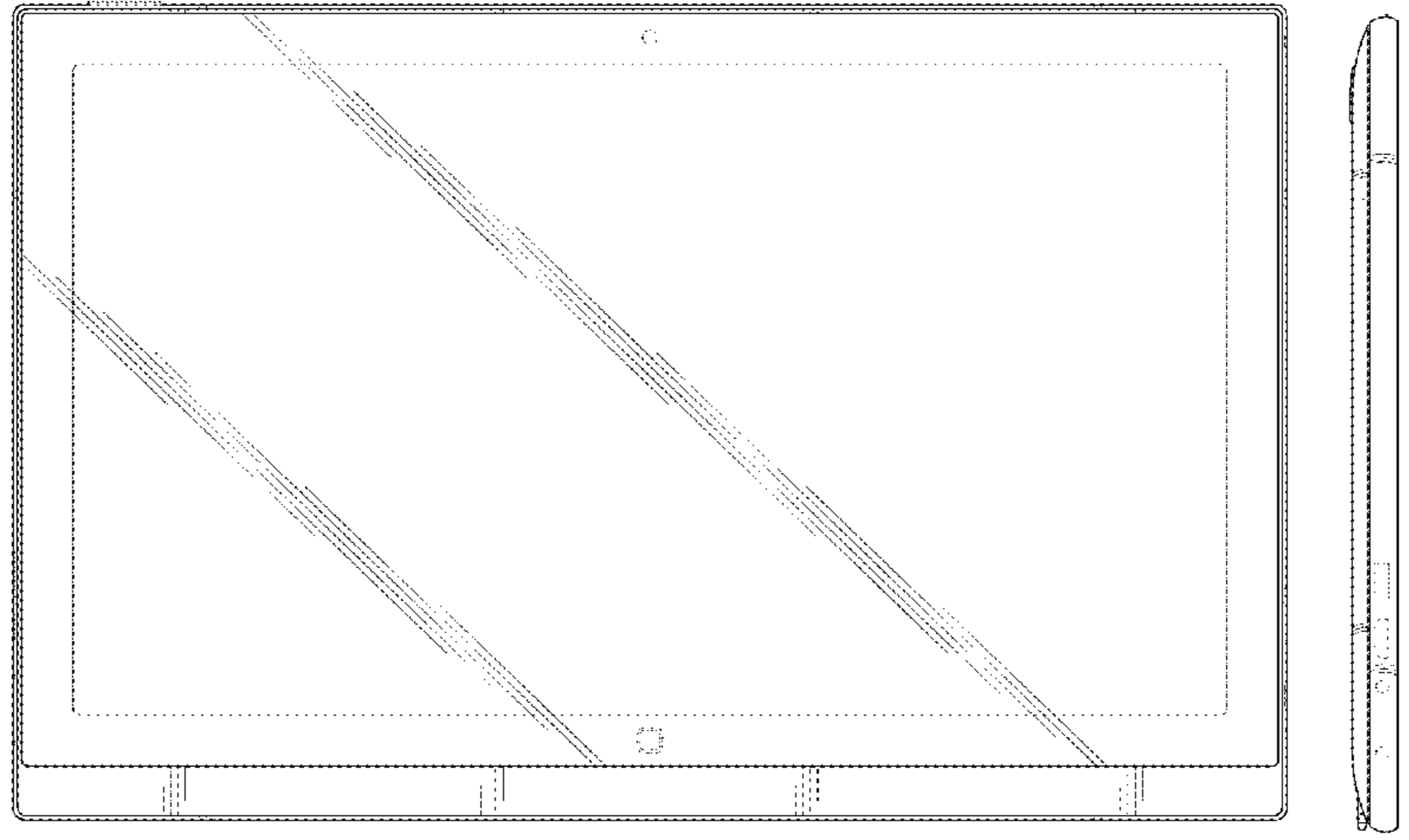

FIG. 1

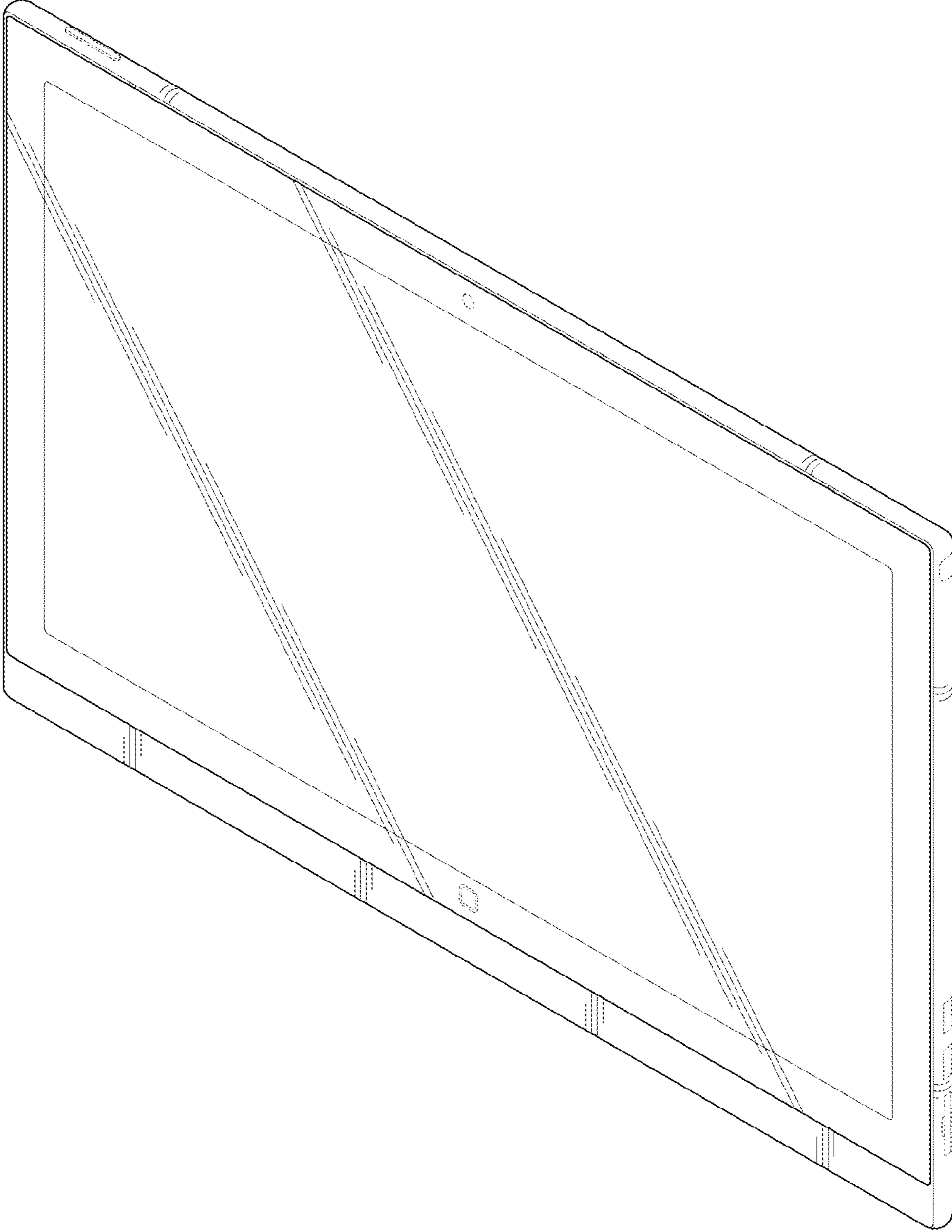

FIG. 2

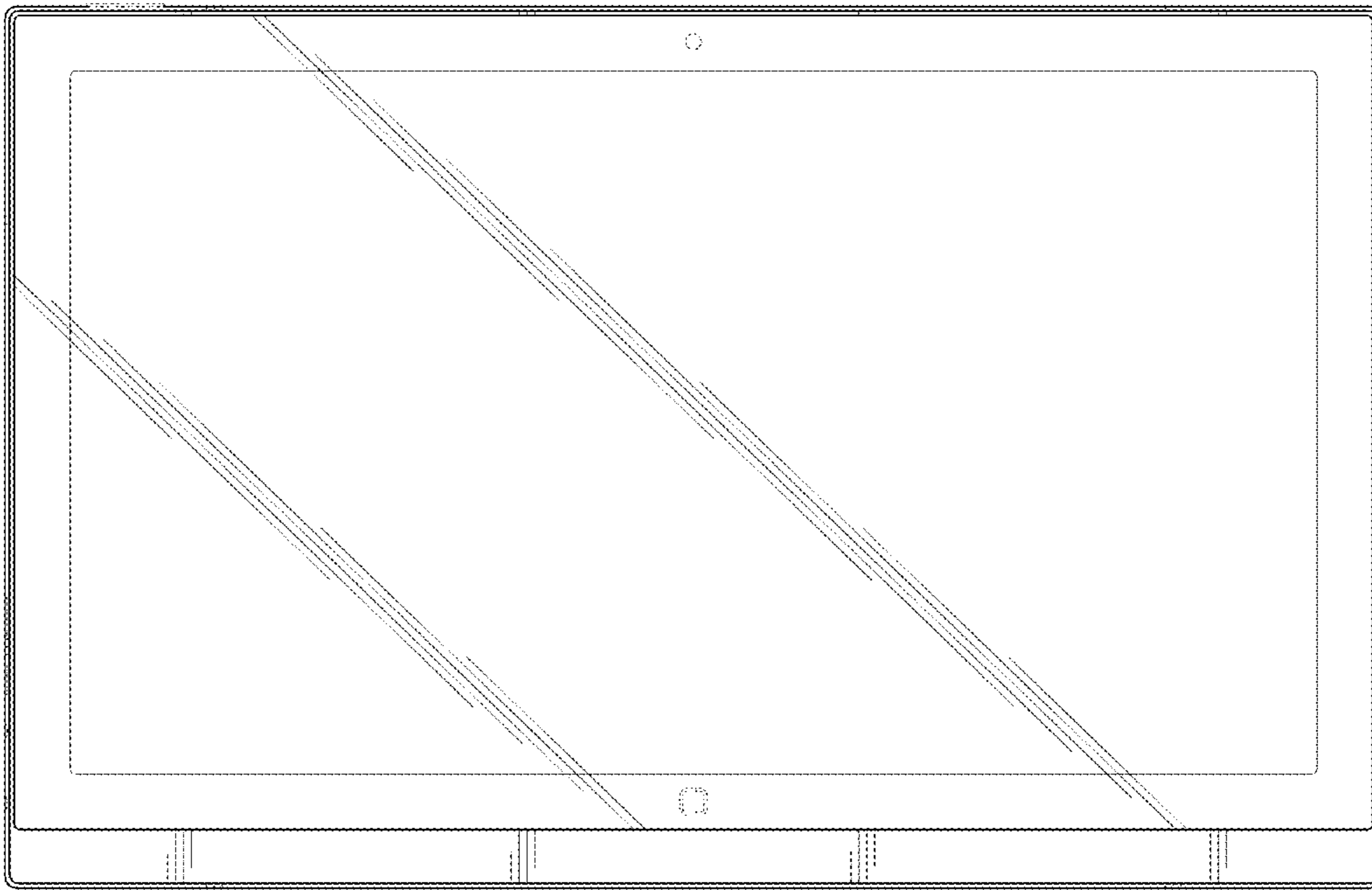

FIG. 3

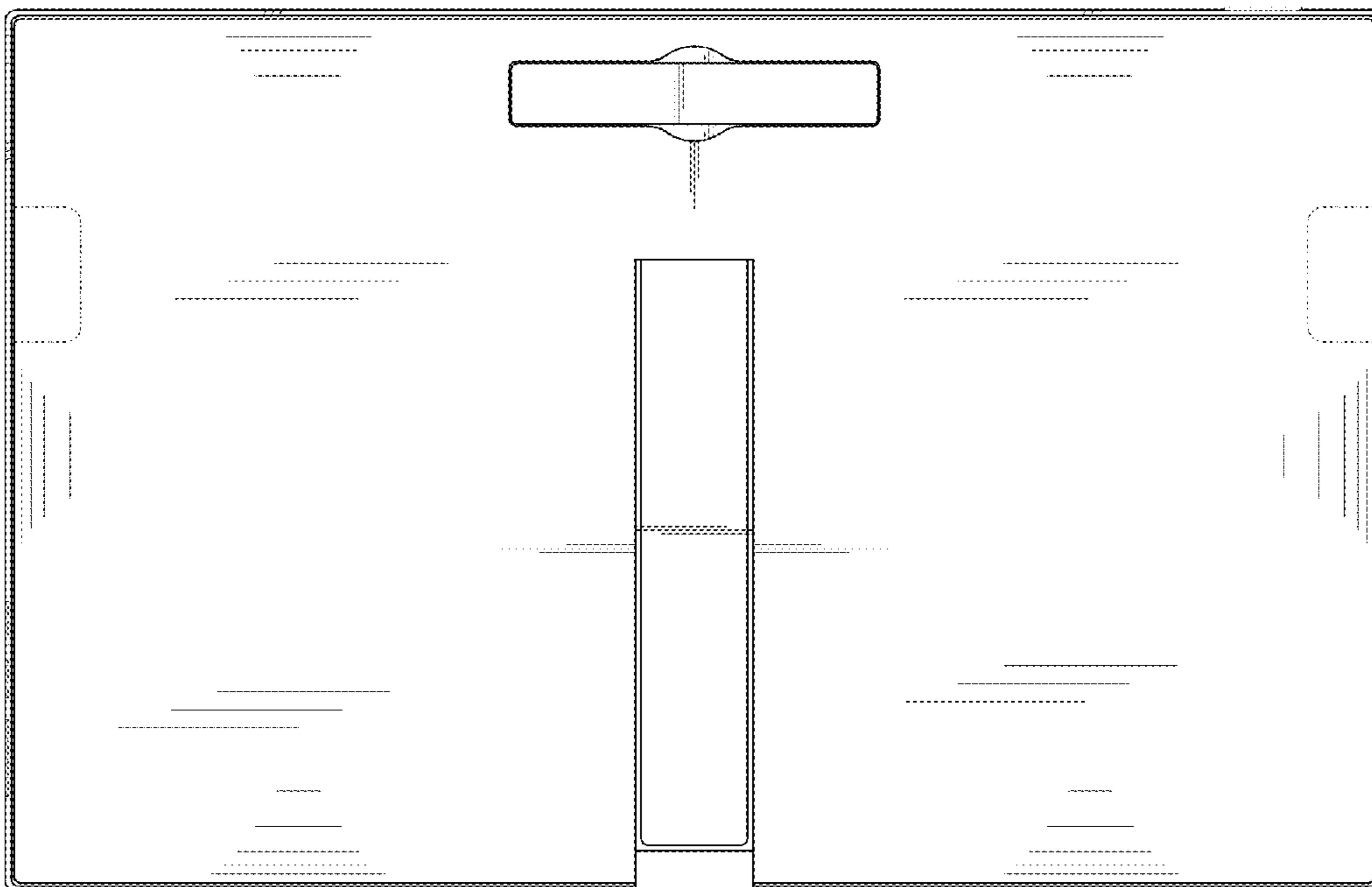

FIG. 4

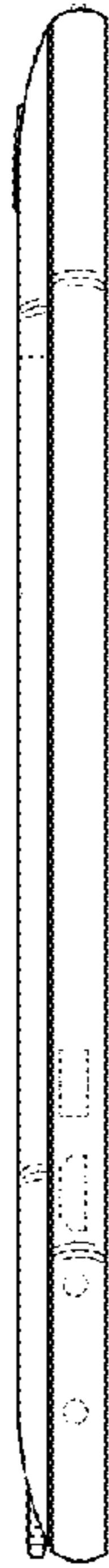

FIG. 5

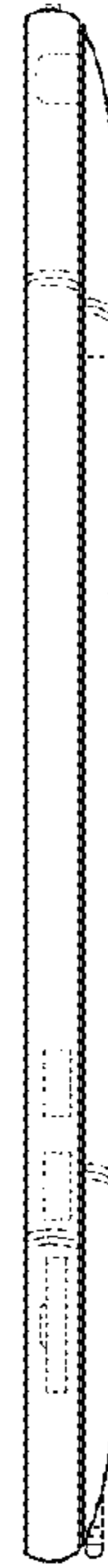

FIG. 6

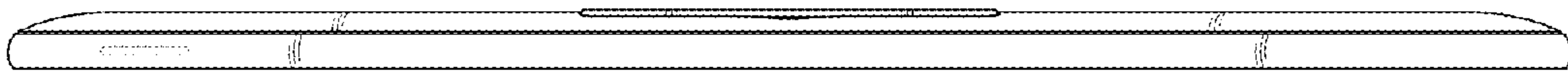

FIG. 7

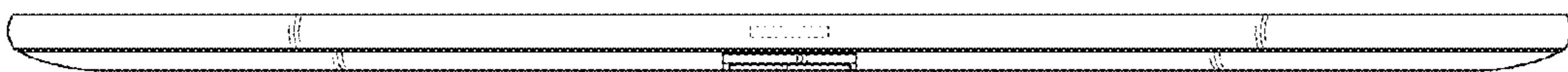

FIG. 8

