



US00D731908S

(12) **United States Design Patent**
Huang

(10) **Patent No.:** **US D731,908 S**
(45) **Date of Patent:** **** Jun. 16, 2015**

(54) **BATTERY TESTER**

(71) Applicant: **Danaher (Shanghai) Industrial Instrumentation Technologies R&D Co., Ltd., Shanghai (CN)**

(72) Inventor: **Wei Huang, Shanghai (CN)**

(73) Assignee: **Danaher (Shanghai) Industrial Instrumentation Technologies R&D Co., LTD., Shanghai (CN)**

(**) Term: **14 Years**

(21) Appl. No.: **29/482,688**

(22) Filed: **Feb. 20, 2014**

(30) **Foreign Application Priority Data**

Sep. 3, 2013 (CN) 2013 3 042879

(51) **LOC (10) Cl.** **10-04**

(52) **U.S. Cl.**
USPC **D10/77; D10/78**

(58) **Field of Classification Search**
USPC **D10/77, 78**
See application file for complete search history.

(56) **References Cited**

U.S. PATENT DOCUMENTS

D515,444 S * 2/2006 Zimmerman et al. D10/77
D569,285 S * 5/2008 Zimmerman et al. D10/77
D611,851 S * 3/2010 Zimmerman et al. D10/77
D643,759 S * 8/2011 Bertness D10/77
2003/0128036 A1 * 7/2003 Henningson et al. 324/426

2012/0038366 A1 * 2/2012 Froman 324/537
2012/0245871 A1 * 9/2012 Sheng et al. 702/63
2014/0092512 A1 * 4/2014 Fan 361/91.1
2014/0123310 A1 * 5/2014 Cherry et al. 726/27

* cited by examiner

Primary Examiner — Antoine D Davis

(74) *Attorney, Agent, or Firm* — Christensen O'Connor Johnson Kindness PLLC

(57) **CLAIM**

The ornamental design for a battery tester, as shown and described.

DESCRIPTION

FIG. 1 is a front, bottom right perspective view of a battery tester showing my new design;
FIG. 2 is a front elevation view thereof;
FIG. 3 is a rear elevation view thereof;
FIG. 4 is a left side elevation view thereof;
FIG. 5 is a right side elevation view thereof;
FIG. 6 is a top plan view thereof;
FIG. 7 is a bottom plan view thereof;
FIG. 8 is a front, bottom right perspective view of another embodiment of the battery tester showing my new design;
FIG. 9 is a front elevation view thereof;
FIG. 10 is a rear elevation view thereof;
FIG. 11 is a left side elevation view thereof;
FIG. 12 is a right side elevation view thereof;
FIG. 13 is a top plan view thereof; and,
FIG. 14 is a bottom plan view thereof.
The broken lines shown in FIGS. 3-7 and 10-14 illustrate environmental subject matter and form no part of the claimed design.

1 Claim, 12 Drawing Sheets

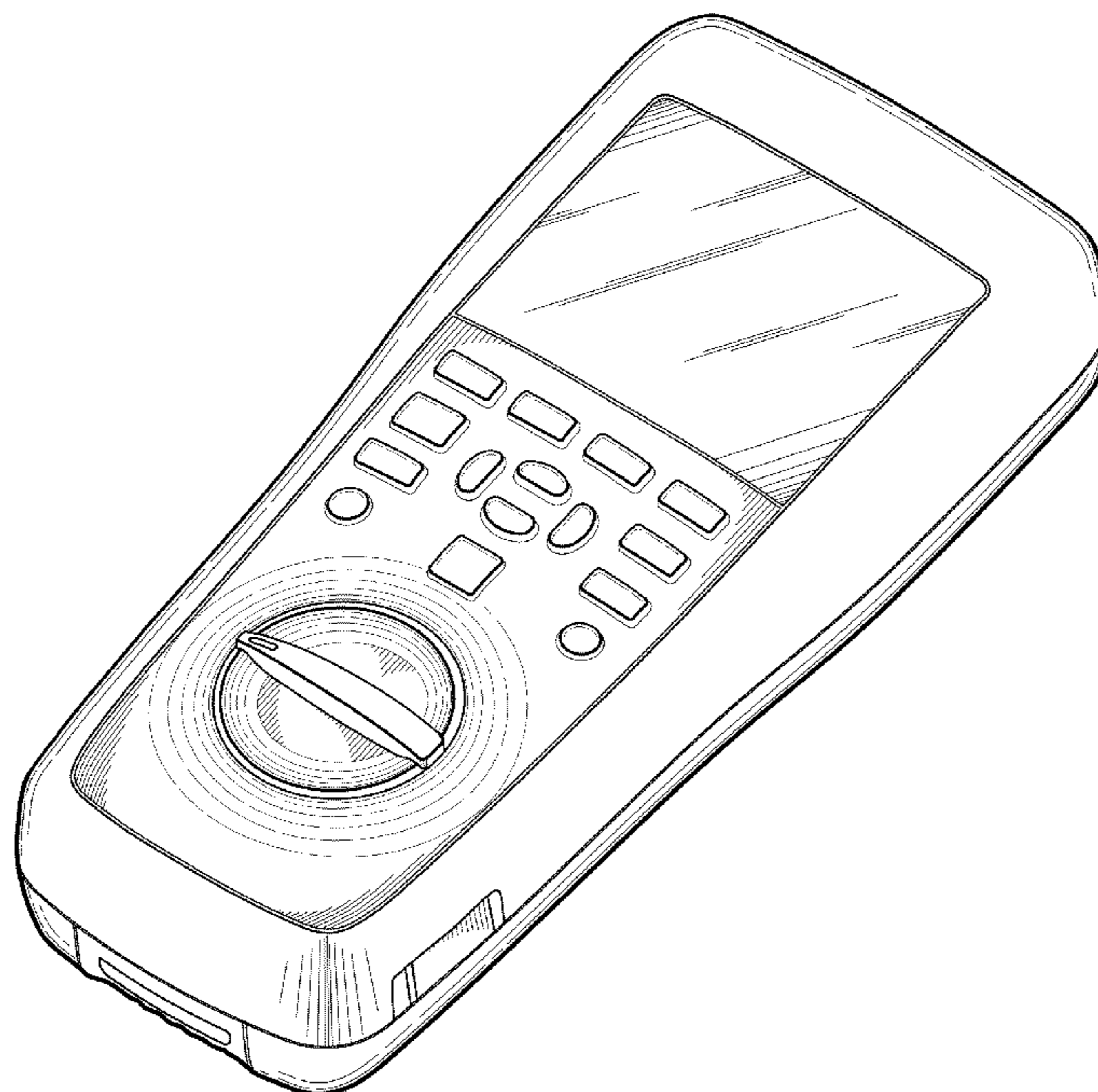

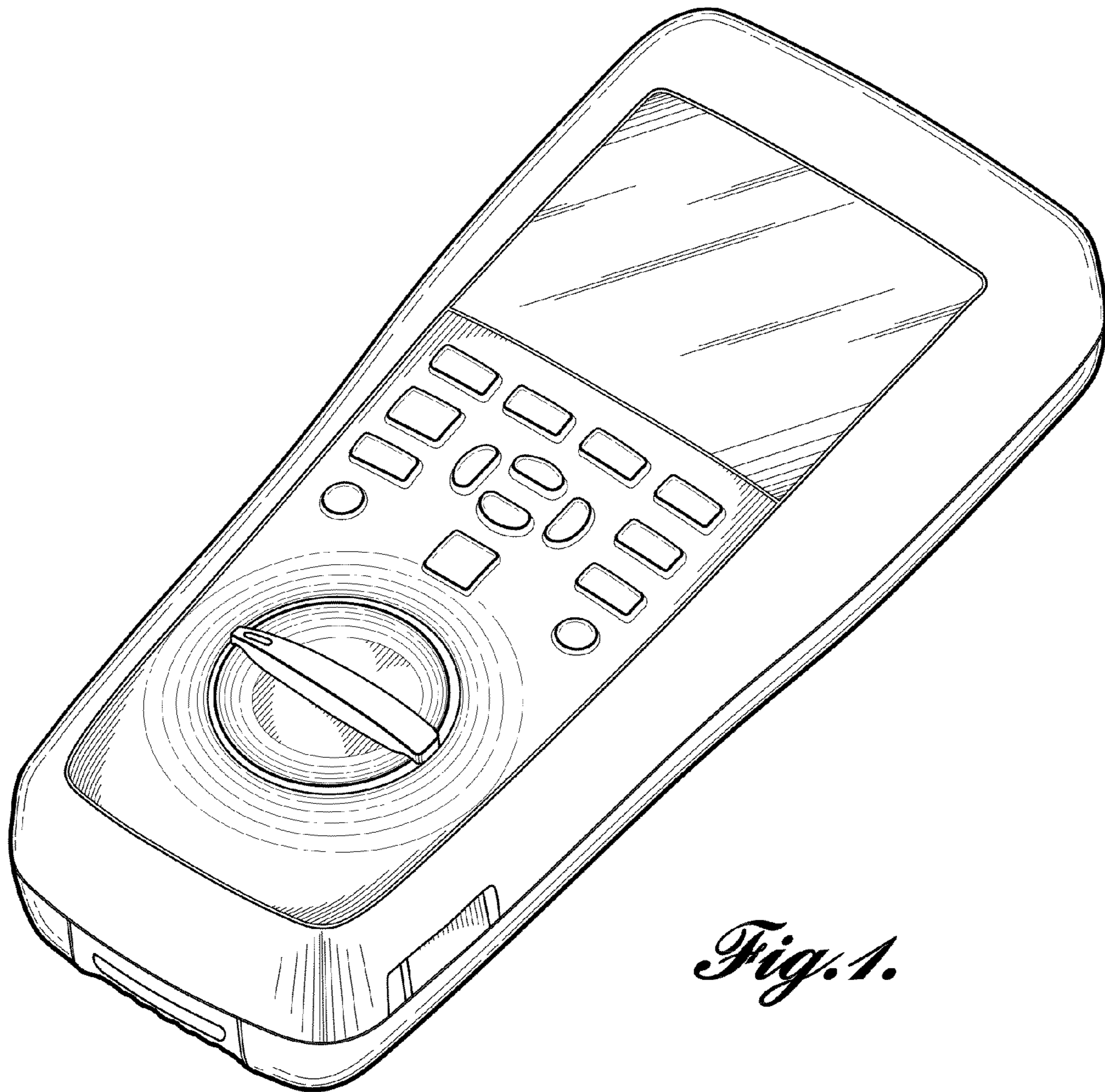

Fig. 1.

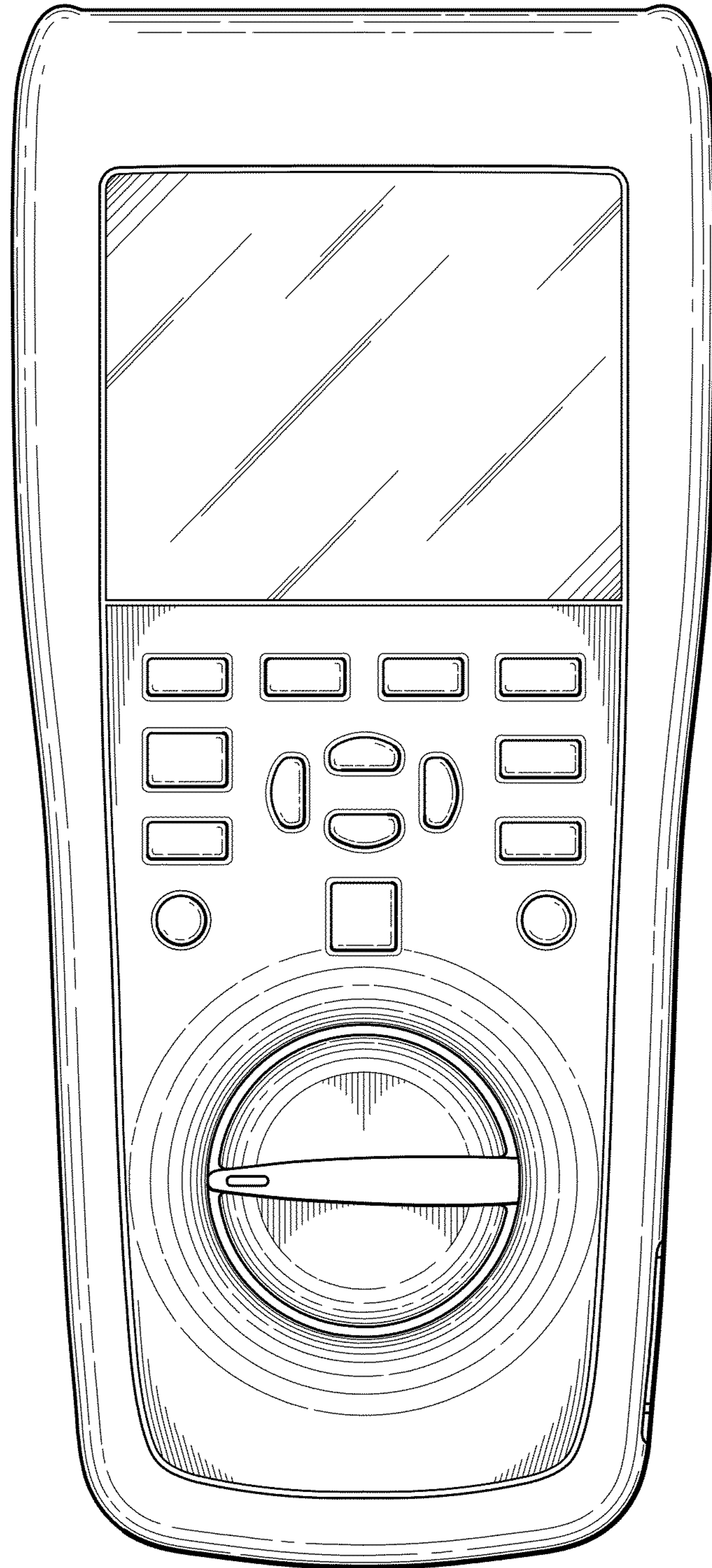

Fig. 2.

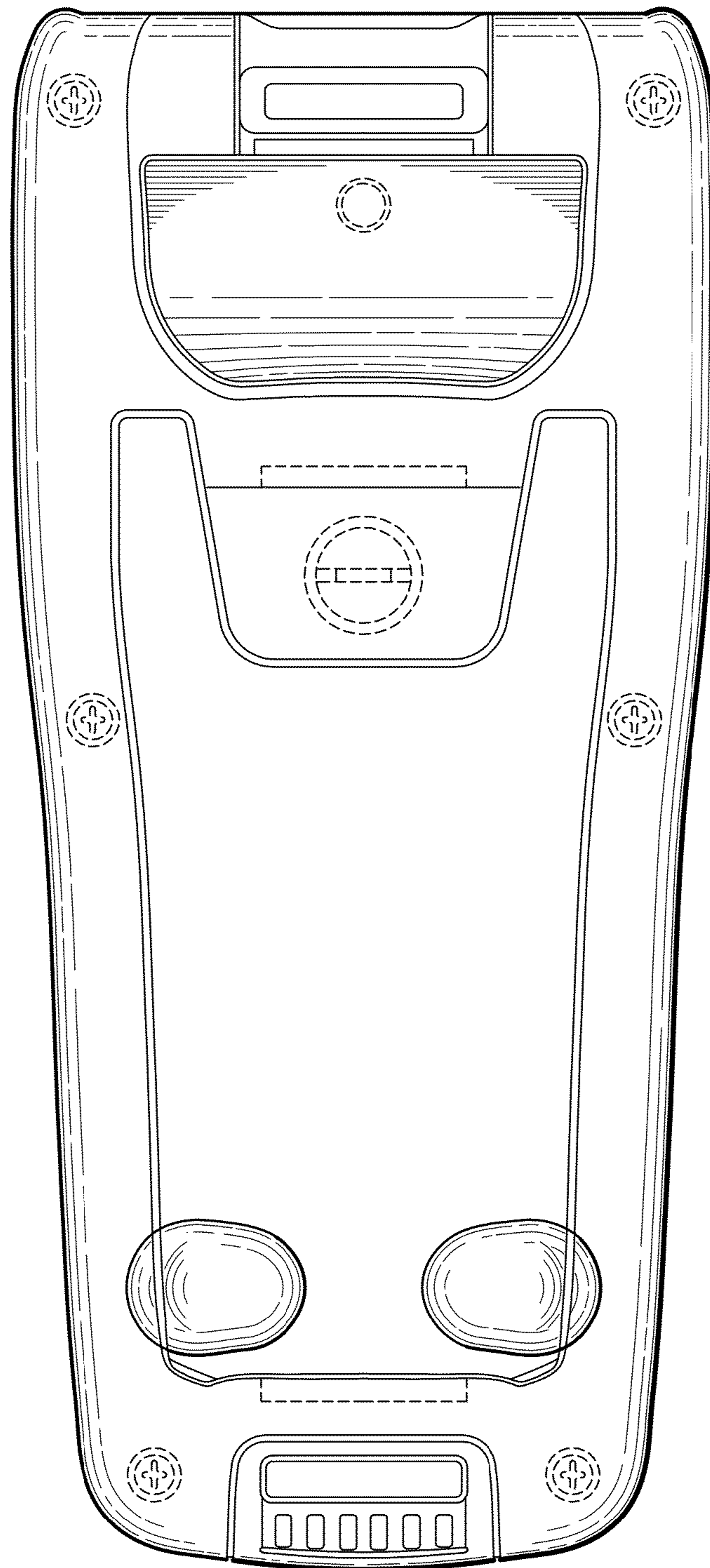

Fig. 3.

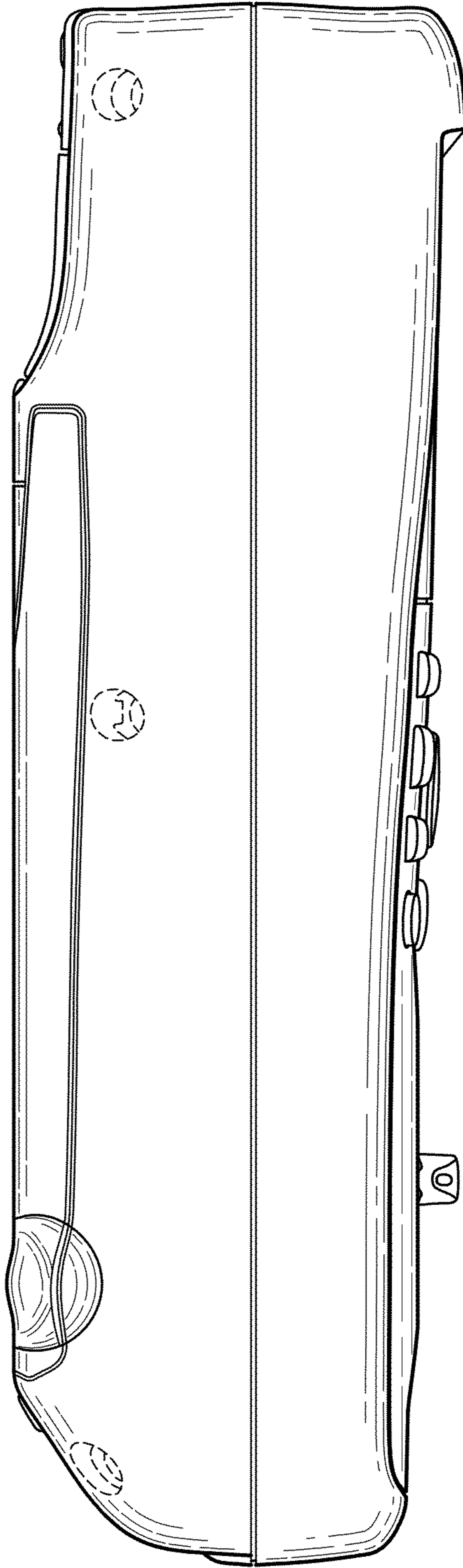

Fig. 4.

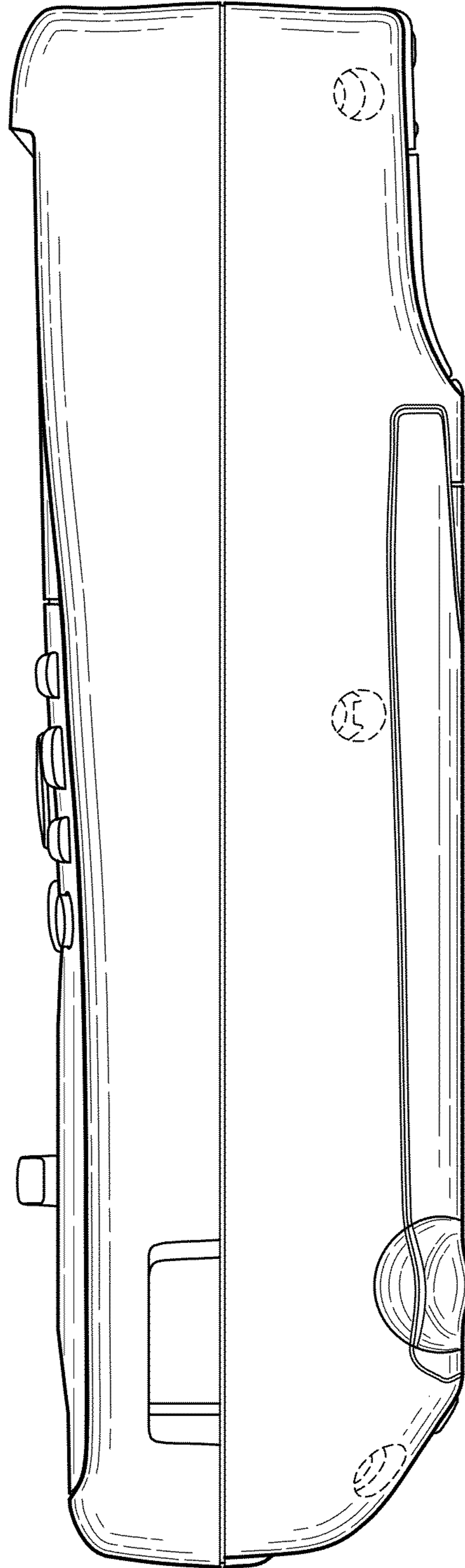

Fig. 5.

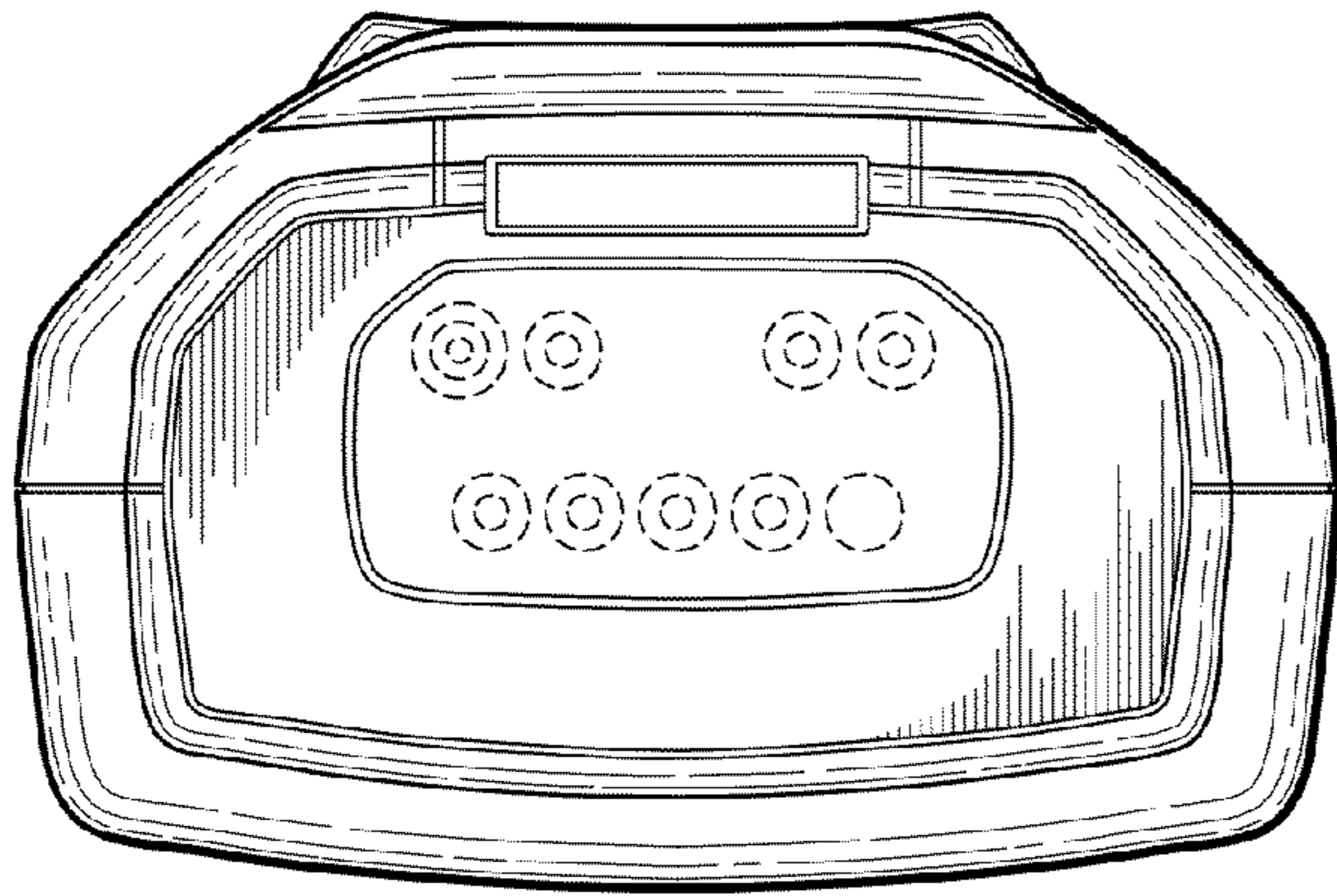

Fig. 6.

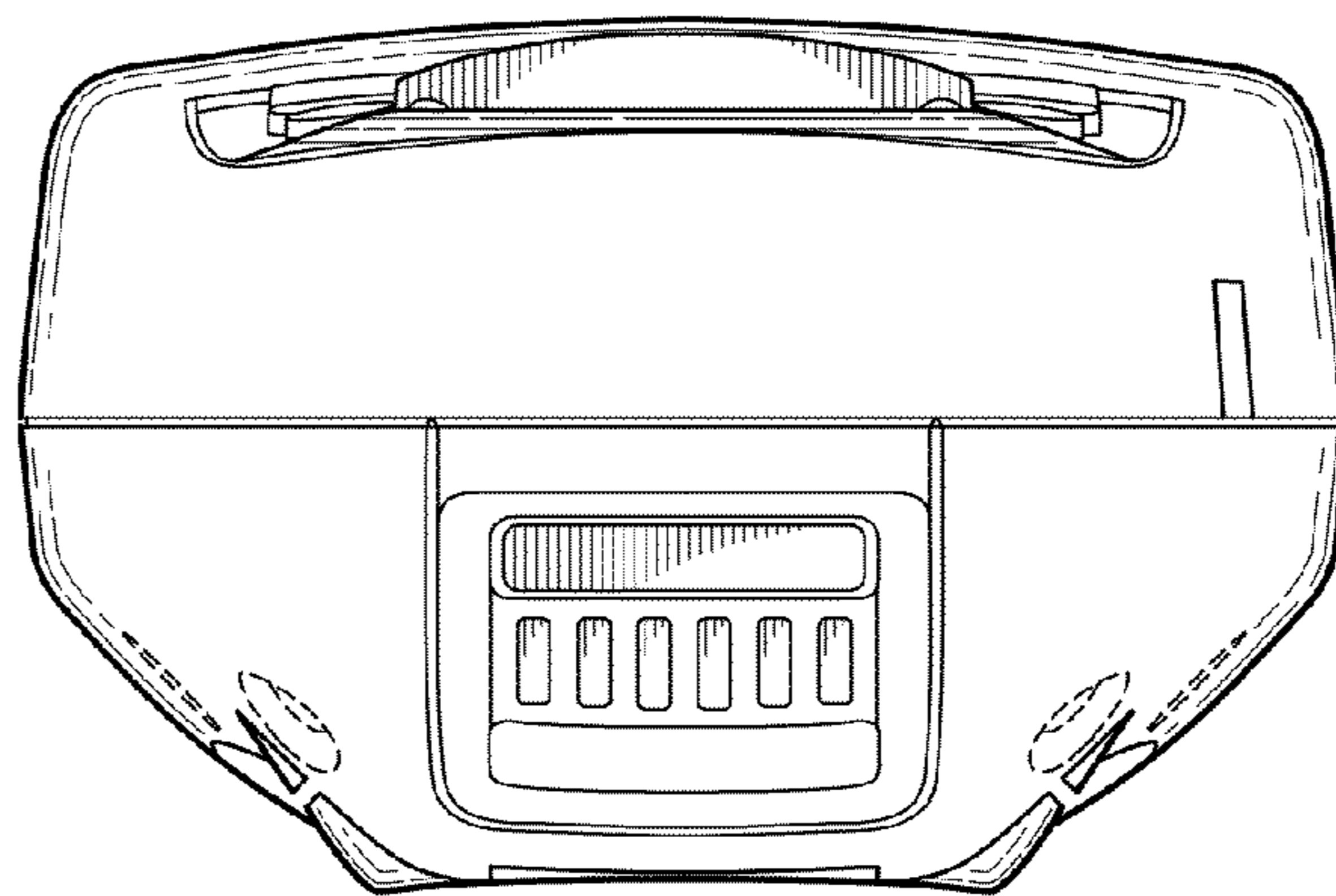

Fig. 7.

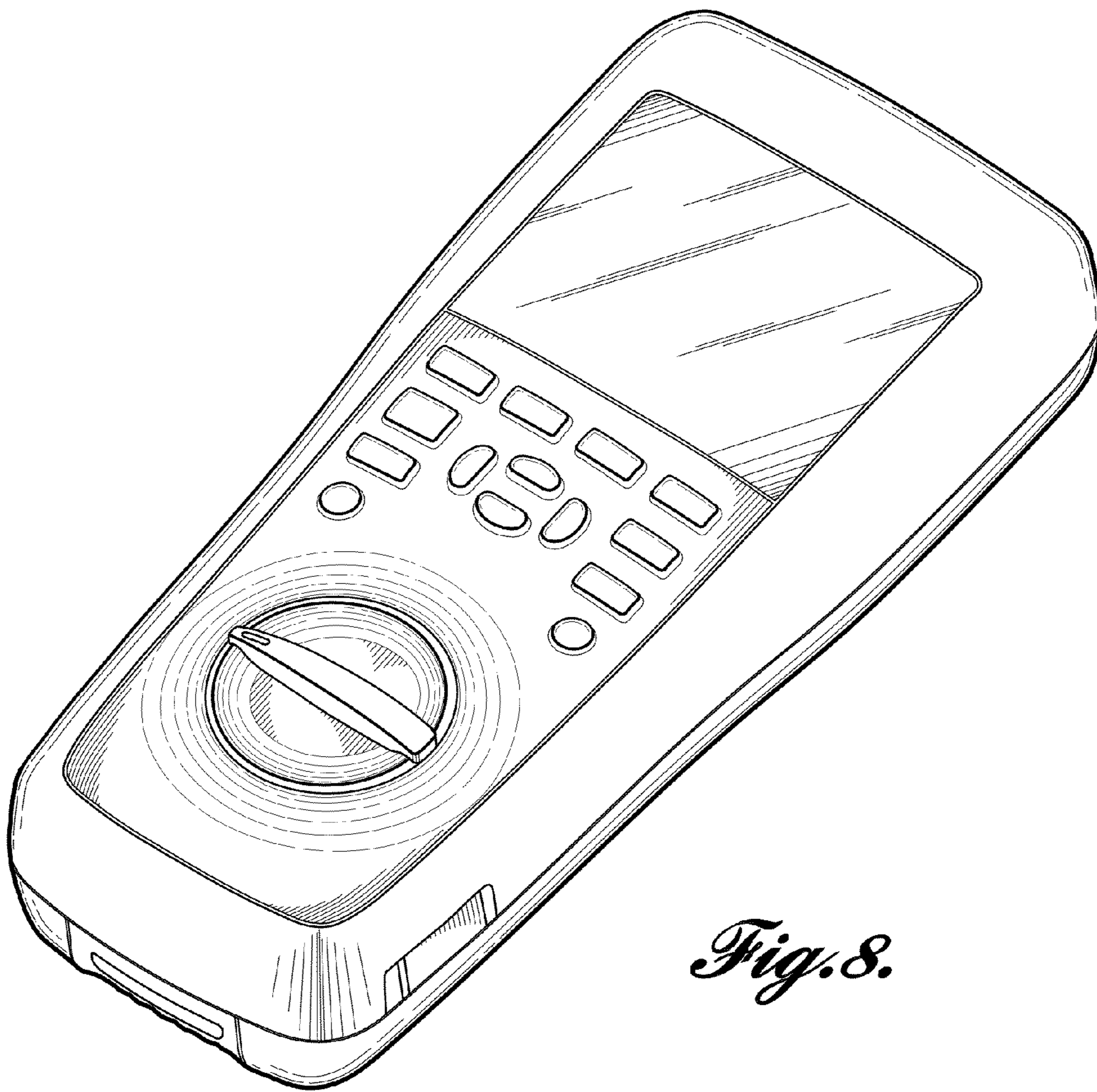

Fig. 8.

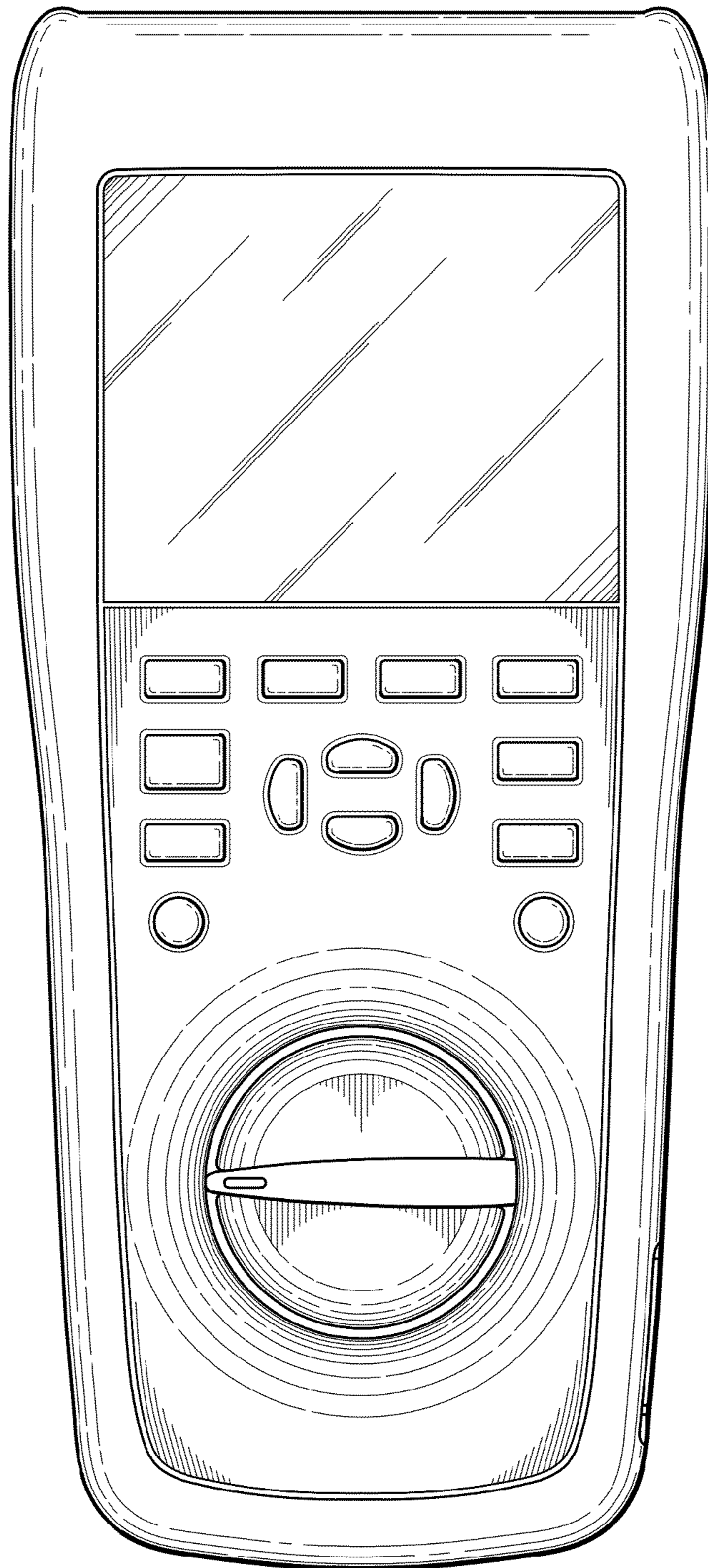

Fig. 9.

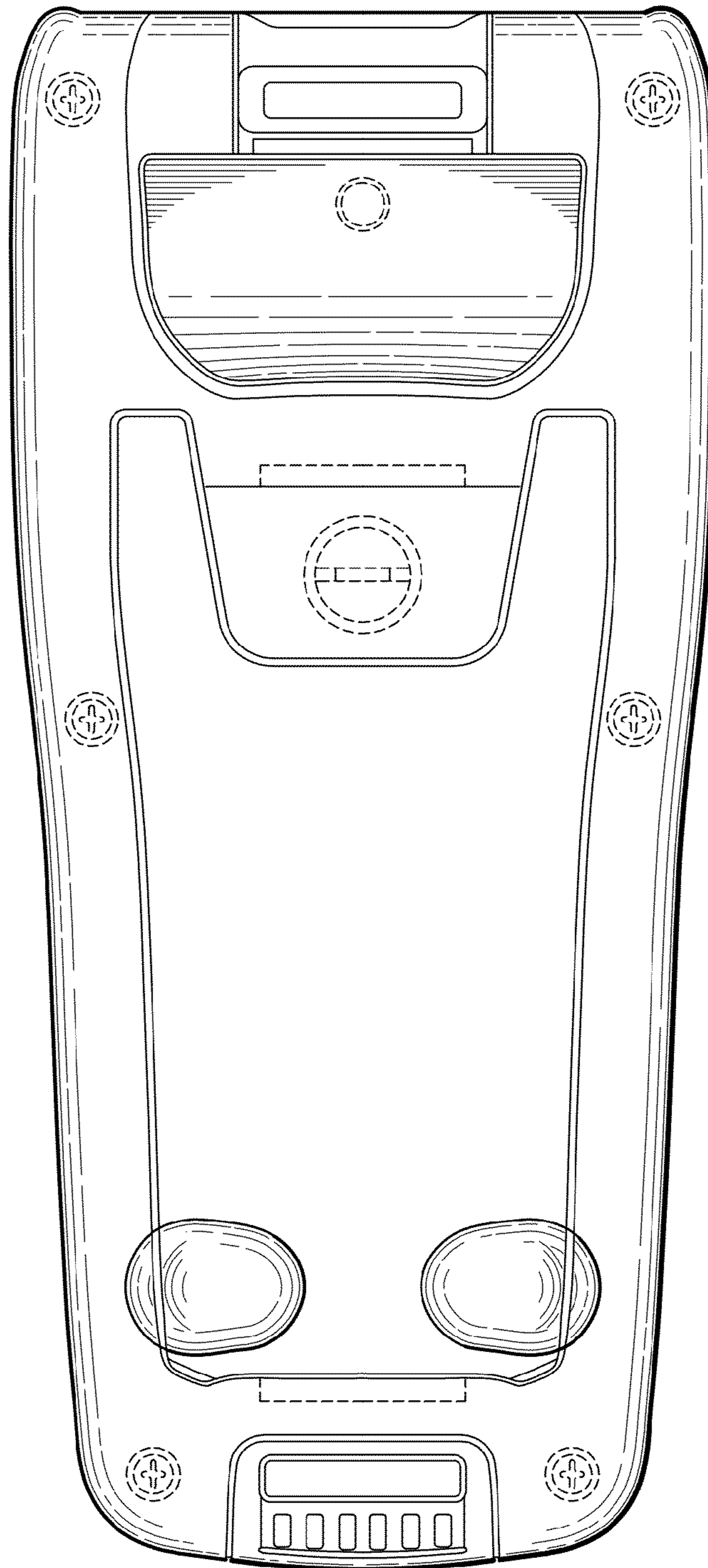

Fig. 10.

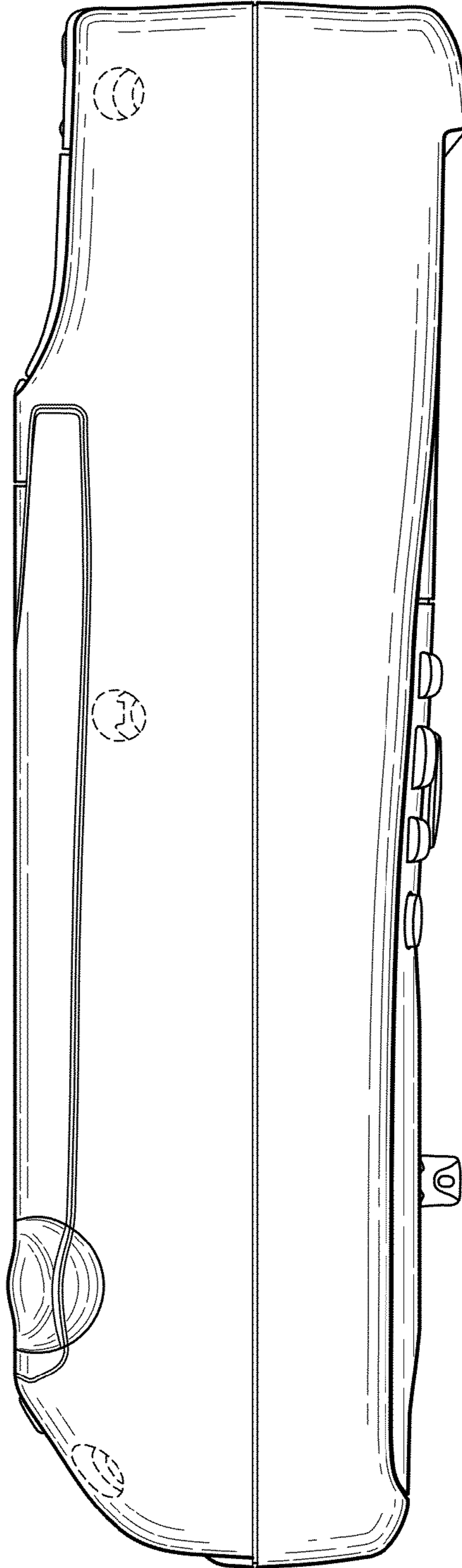

Fig. 11.

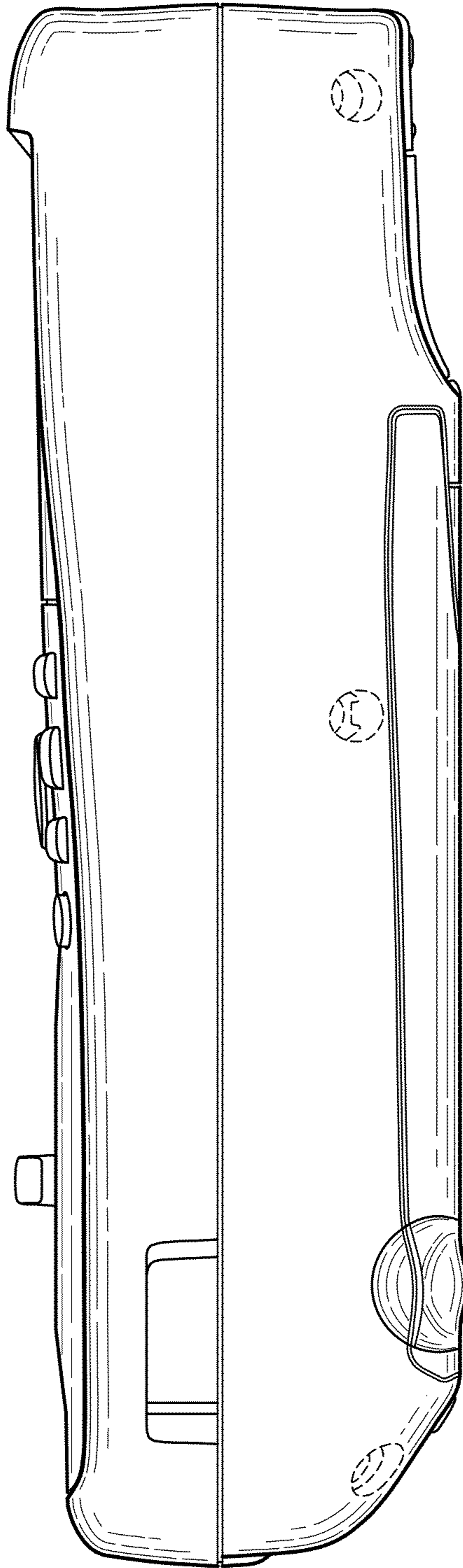

Fig. 12.

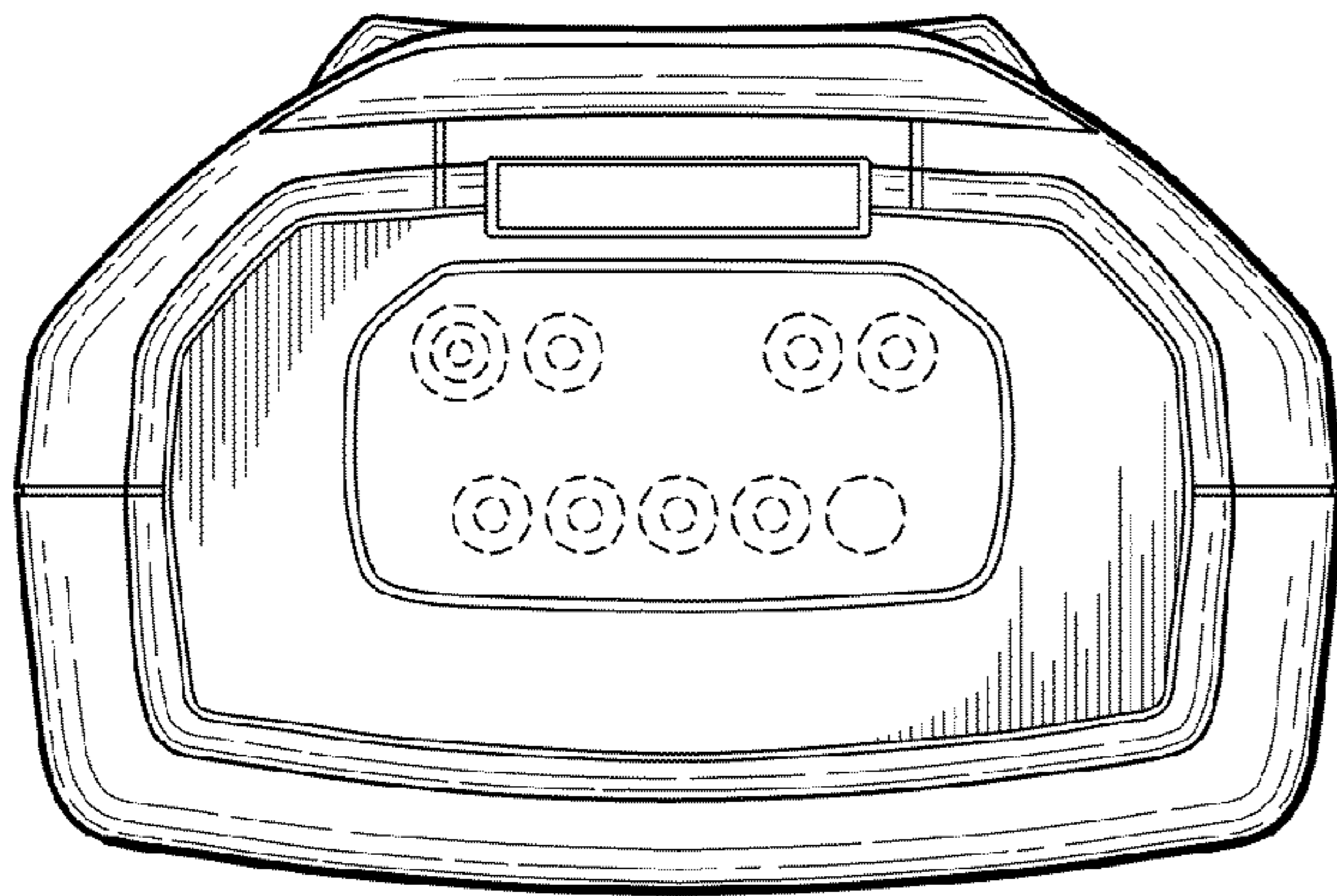

Fig. 13.

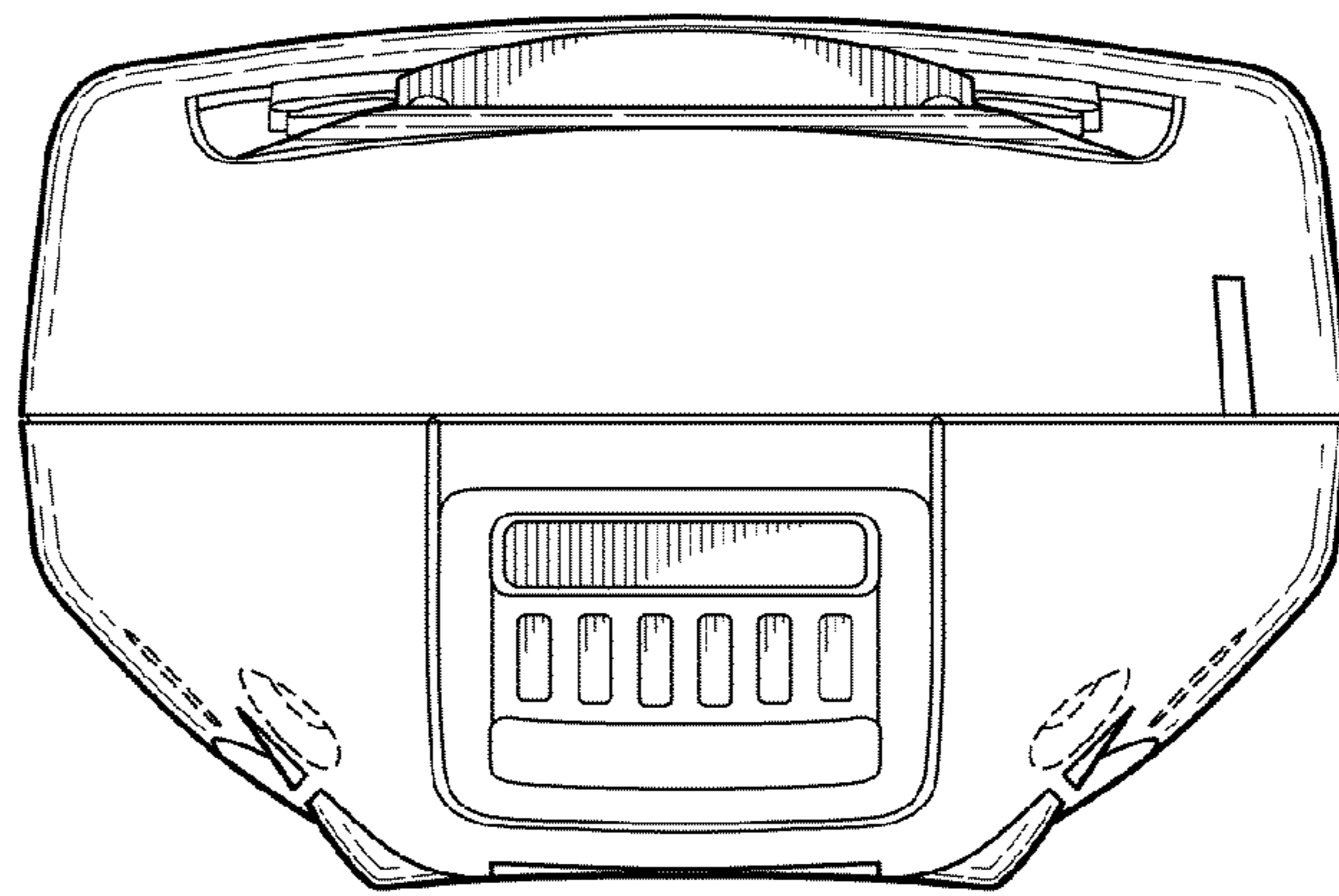

Fig. 14.