



US00D731838S

(12) **United States Design Patent**  
**Kitano et al.**

(10) **Patent No.:** **US D731,838 S**  
(45) **Date of Patent:** **\*\* Jun. 16, 2015**

(54) **BEER DISPENSER**

(56) **References Cited**

(71) Applicants: **Junichi Kitano**, Moriya (JP); **Kenji Kato**, Tokyo (JP); **Teruhiko Kitamura**, Tokyo (JP)

U.S. PATENT DOCUMENTS

2,876,042 A *	3/1959	Steele .....	239/445
3,355,068 A *	11/1967	Harland et al. ....	222/30
D280,880 S *	10/1985	Schweres .....	D7/398
D411,710 S *	6/1999	Watters et al. ....	D7/398
D483,609 S *	12/2003	Guadalupi .....	D7/398
D485,121 S *	1/2004	Ahlgrim et al. ....	D7/398
D590,207 S *	4/2009	Bronwasser .....	D7/398
D636,224 S *	4/2011	Shin .....	D7/398
D694,055 S *	11/2013	Hirst .....	D7/306
D702,475 S *	4/2014	Dalton et al. ....	D7/306
D708,011 S *	7/2014	Liberatore .....	D7/398

(72) Inventors: **Junichi Kitano**, Moriya (JP); **Kenji Kato**, Tokyo (JP); **Teruhiko Kitamura**, Tokyo (JP)

(73) Assignee: **ASAHI BREWERIES, LTD.**, Tokyo (JP)

\* cited by examiner

(\*\*) Term: **14 Years**

*Primary Examiner* — Marianne Pandozzi

(21) Appl. No.: **29/463,508**

(74) *Attorney, Agent, or Firm* — Manabu Kanesaka

(22) Filed: **Dec. 16, 2013**

(57) **CLAIM**

The ornamental design for a beer dispenser, as shown and described.

(30) **Foreign Application Priority Data**

**DESCRIPTION**

Jul. 9, 2013 (JP) ..... 2013-015603

FIG. 1 is a perspective view of a beer dispenser showing our new design;

(51) **LOC (10) Cl.** ..... **07-01**

FIG. 2 is a front view thereof;

(52) **U.S. Cl.**

FIG. 3 is a rear view thereof;

USPC ..... **D7/306**; D7/397; D7/398

FIG. 4 is a left side view thereof;

(58) **Field of Classification Search**

FIG. 5 is a right side view thereof;

USPC ..... D7/397, 301, 300, 398, 313, 306-308;  
239/445, 583; 222/511, 25, 192,  
222/153.02

FIG. 6 is a top plan view thereof; and,

CPC ..... B67D 1/0084; B67D 1/0086

FIG. 7 is a bottom view thereof.

See application file for complete search history.

The broken lines in FIG. 7 are included for the purpose of illustration and form no part of the claimed design.

**1 Claim, 7 Drawing Sheets**

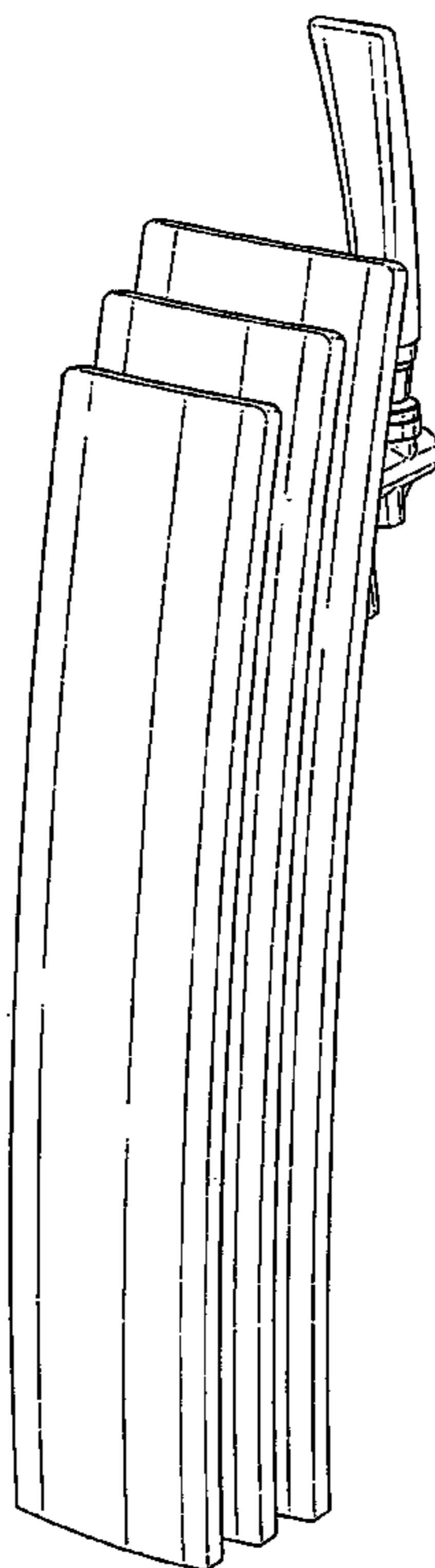

Fig. 1

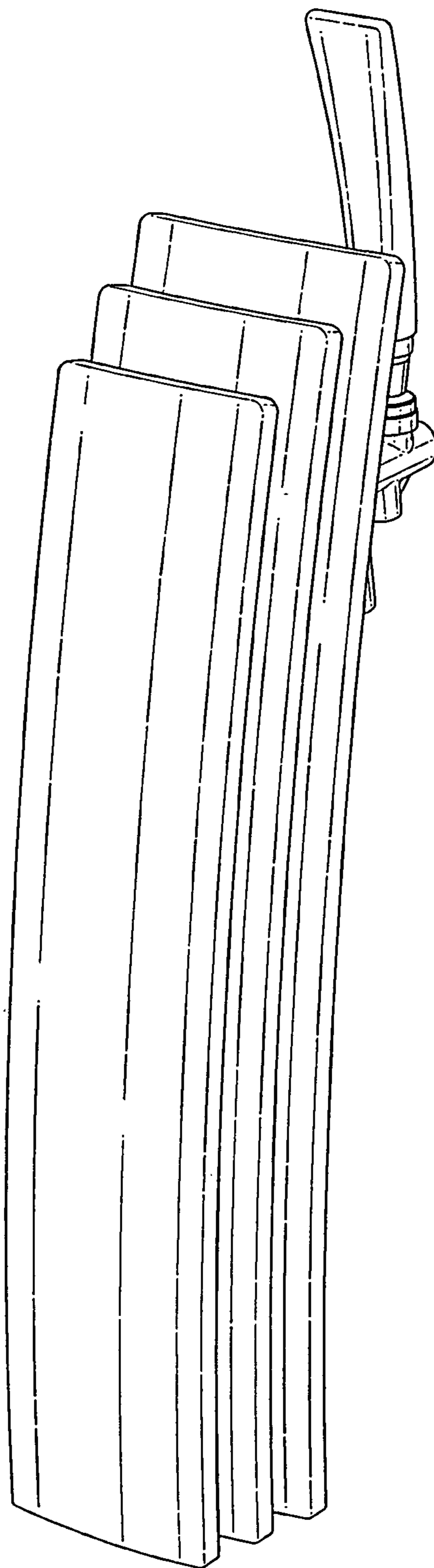

Fig. 2

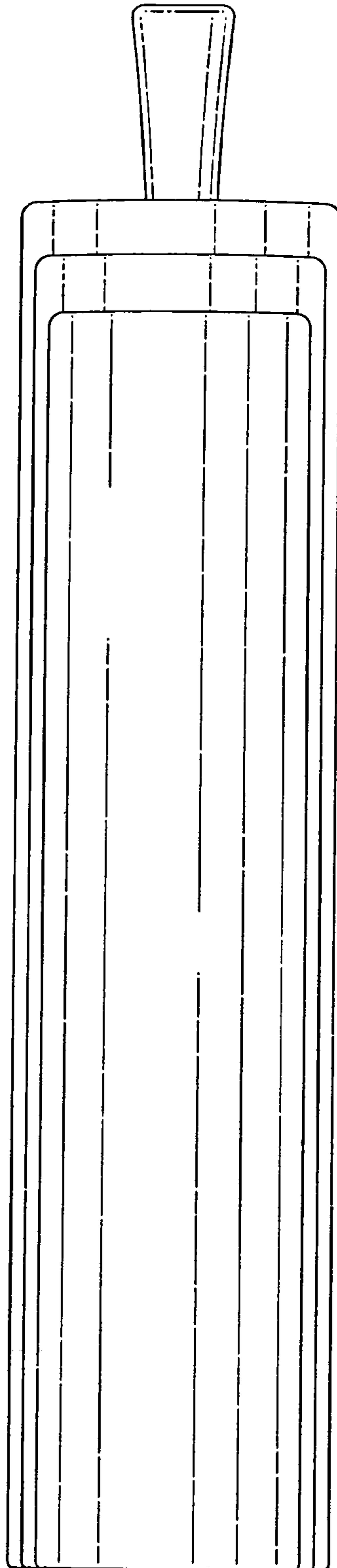

Fig. 3

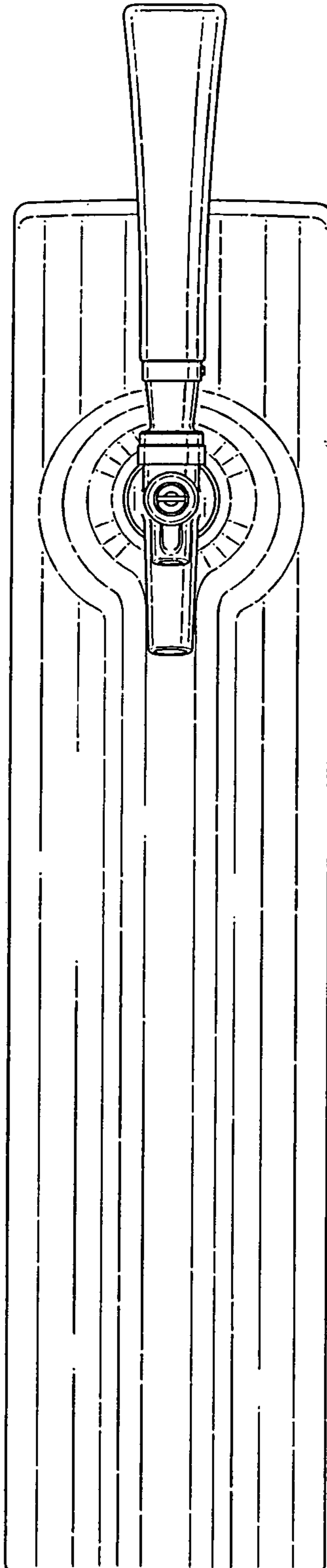

Fig. 4

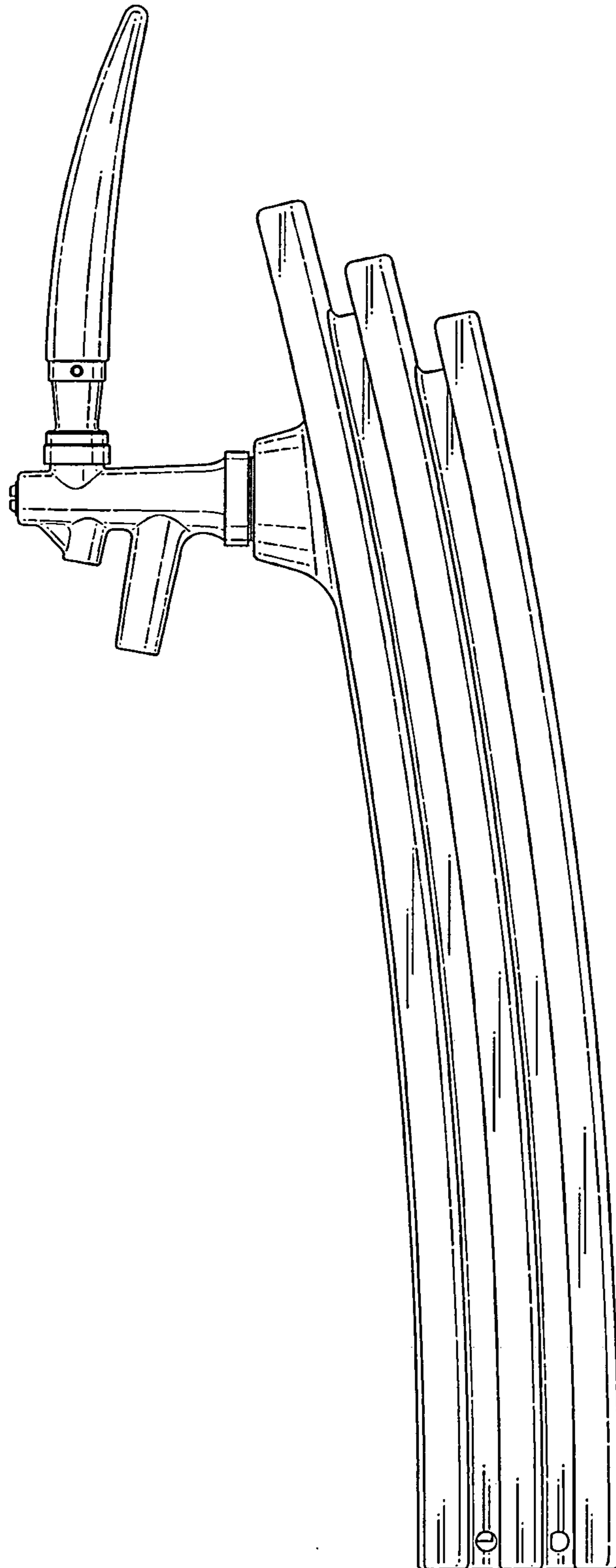

Fig. 5

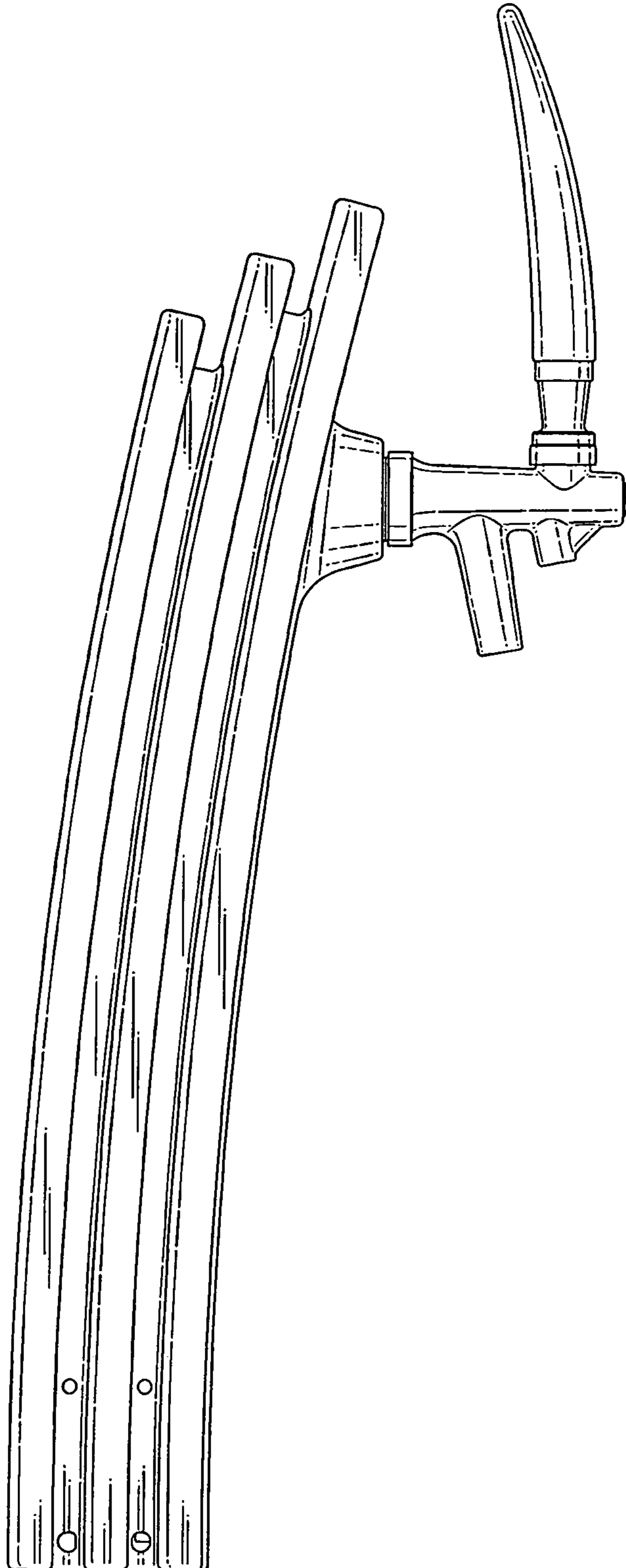

Fig. 6

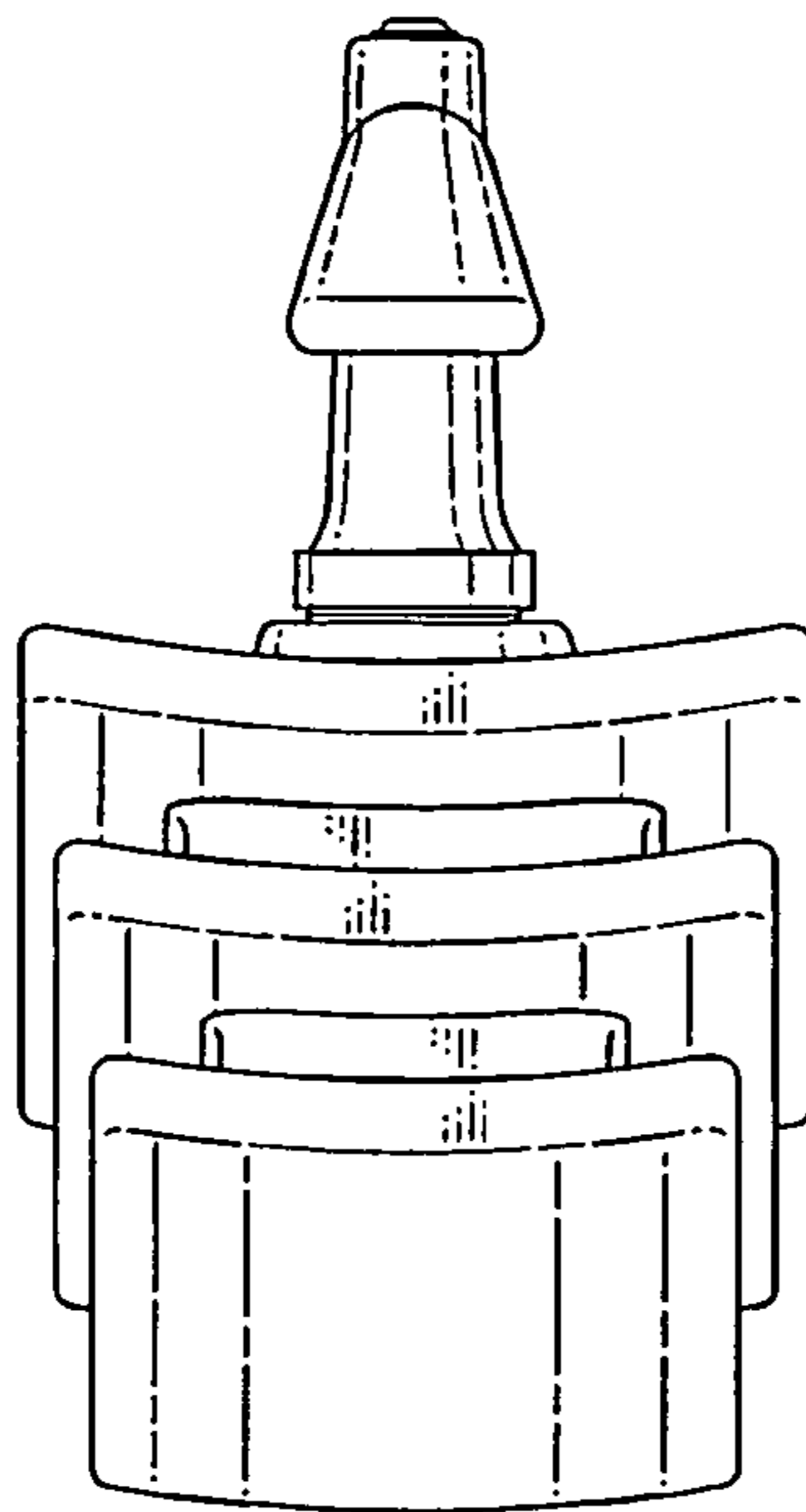

Fig. 7

