



US00D731812S

(12) **United States Design Patent**
Beebe et al.

(10) **Patent No.:** **US D731,812 S**
(45) **Date of Patent:** **** Jun. 16, 2015**

(54) **HOLDER FOR CLEANING ITEMS OR SIMILAR ARTICLES**

(71) Applicant: **Evrholder Products, LLC**, Anaheim, CA (US)
(72) Inventors: **Joel Beebe**, Columbus, OH (US); **Nicholas Vallo**, New Albany, OH (US); **Christopher Brown**, Columbus, OH (US); **Matthew Seibert**, Columbus, OH (US); **Bret Gould**, Worthington, OH (US); **Christopher Hawker**, Columbus, OH (US); **Abraham Alexander**, Columbus, OH (US)

(73) Assignee: **Evrholder Products, LLC**, Anaheim, CA (US)

(**) Term: **14 Years**

(21) Appl. No.: **29/482,844**

(22) Filed: **Feb. 21, 2014**

(51) **LOC (10) Cl.** **06-04**

(52) **U.S. Cl.**
USPC **D6/553**

(58) **Field of Classification Search**
USPC D6/553, 554, 567, 572, 569; D8/349, D8/354, 367, 380; 211/13.1, 60.1, 86.01, 211/87.01, 89.01, 90.04, 66, 70.6; 248/304, 248/309.1, 316.1, 316.3

See application file for complete search history.

(56) **References Cited**

U.S. PATENT DOCUMENTS

D175,455 S *	8/1955	Bartleman	D6/572
4,134,499 A *	1/1979	Joswig	211/66
D275,629 S *	9/1984	Einhorn	D8/372
D302,503 S *	8/1989	Gerry et al.	D6/553
D392,142 S *	3/1998	Weisburn et al.	D6/567
D418,351 S *	1/2000	Lee	D6/567
D456,656 S *	5/2002	Ng	D6/553
D498,963 S *	11/2004	Sung-Feng	D6/553
D509,391 S *	9/2005	Hamori	D6/553

* cited by examiner

Primary Examiner — Brian N Vinson

(74) *Attorney, Agent, or Firm* — Louis C. Paul

(57) **CLAIM**

The ornamental design for a holder for cleaning items or similar articles, as shown and described.

DESCRIPTION

FIG. 1 is a front view of the present invention.
FIG. 2 is a right side view of the present invention.
FIG. 3 is a left side view of the present invention.
FIG. 4 is a rear view of the present invention.
FIG. 5 is a top view of the present invention.
FIG. 6 is a bottom view of the present invention.
FIG. 7 is a bottom perspective view of the present invention.
FIG. 8 is a top perspective view of the present invention; and,
FIG. 9 is an exploded view of the present invention.

1 Claim, 9 Drawing Sheets

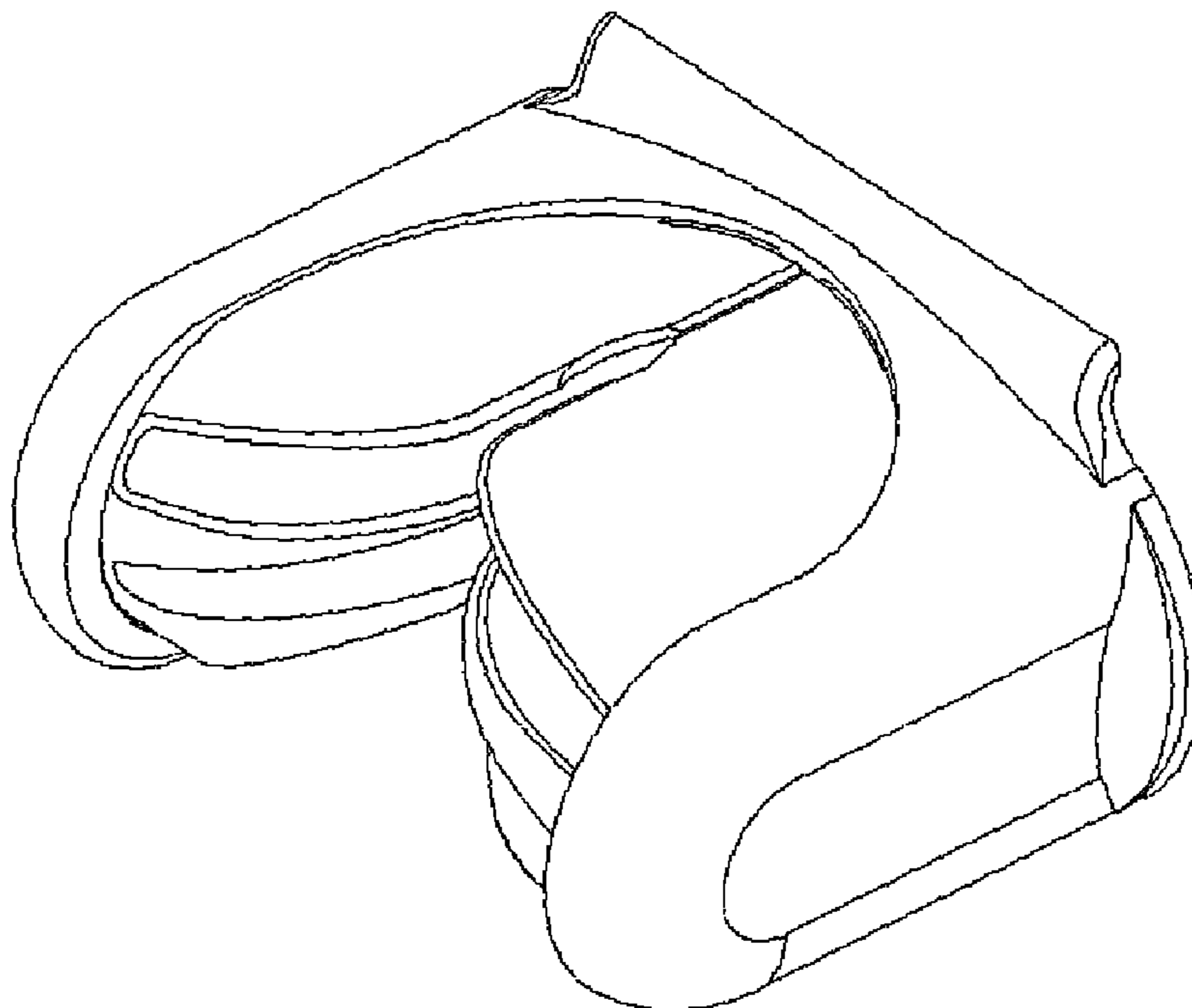

Fig. 1

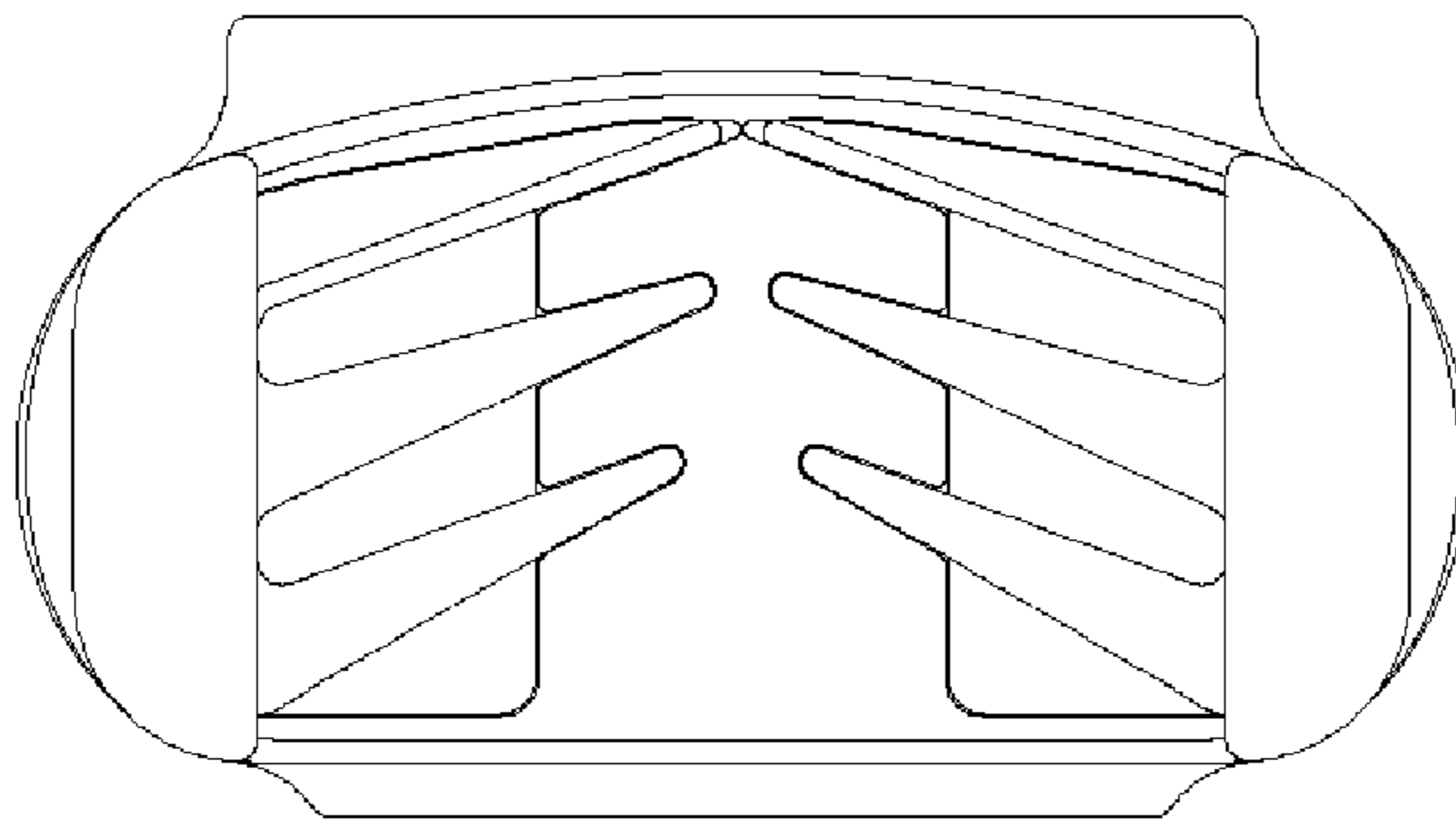

Fig. 2

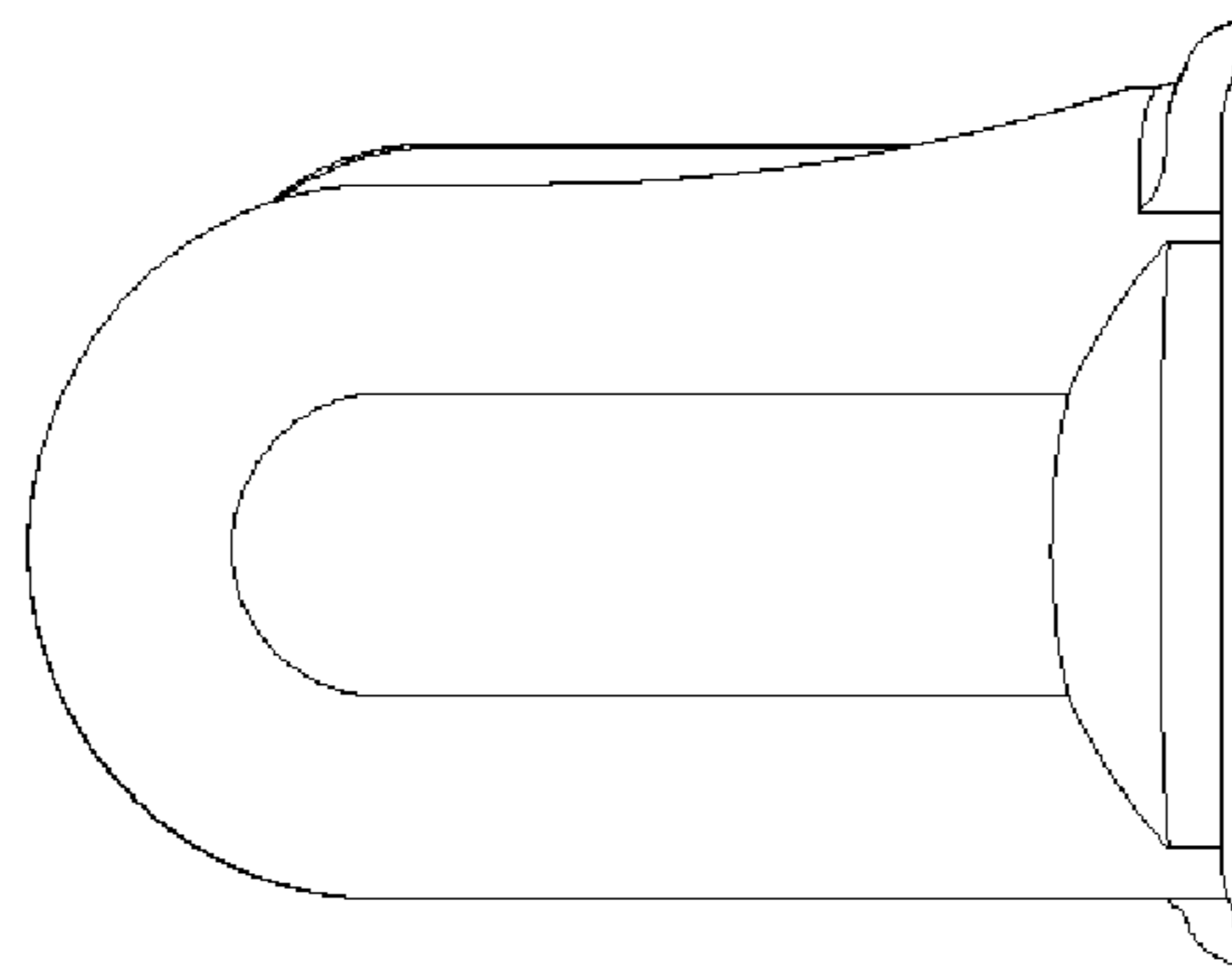

Fig. 3

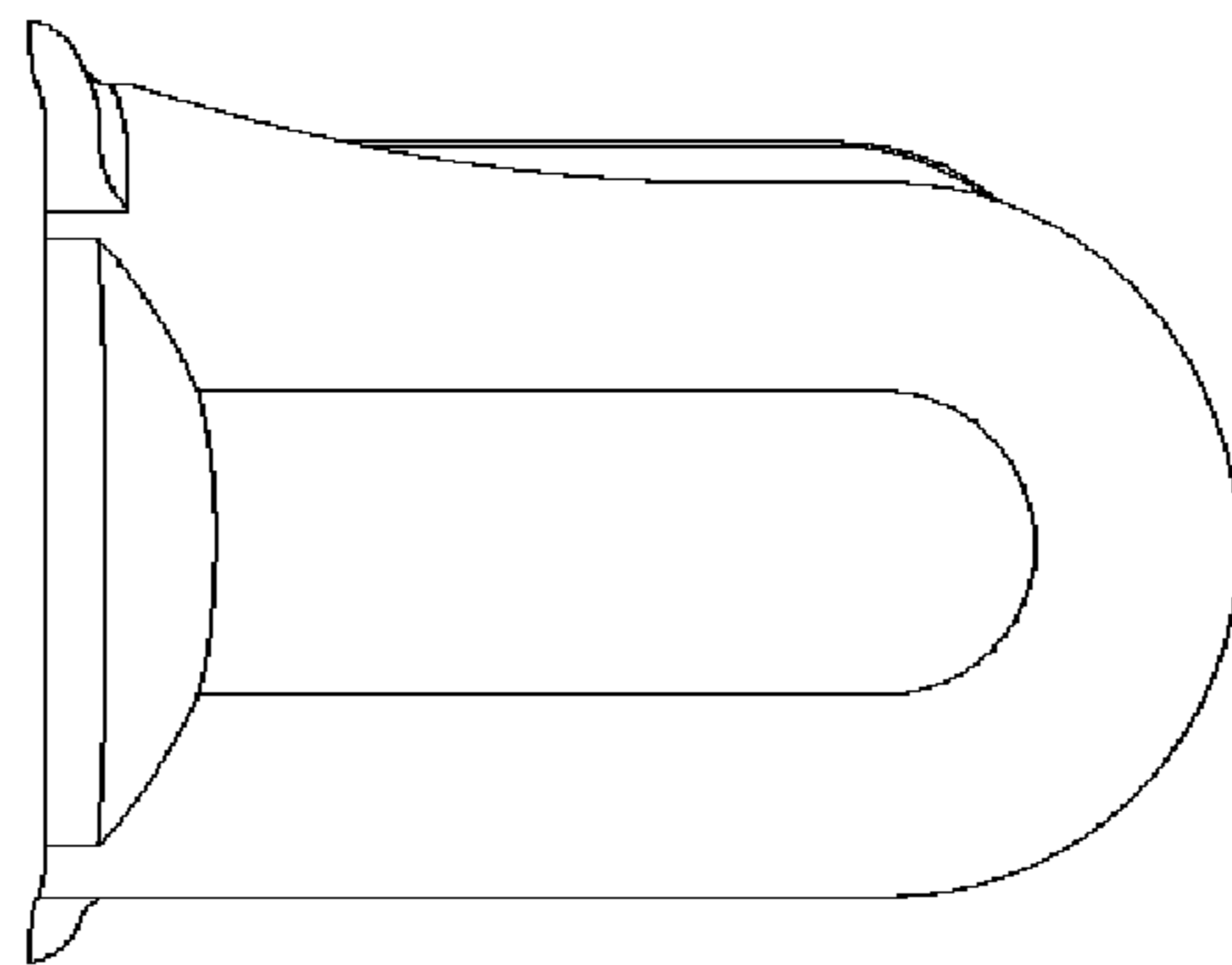

Fig. 4

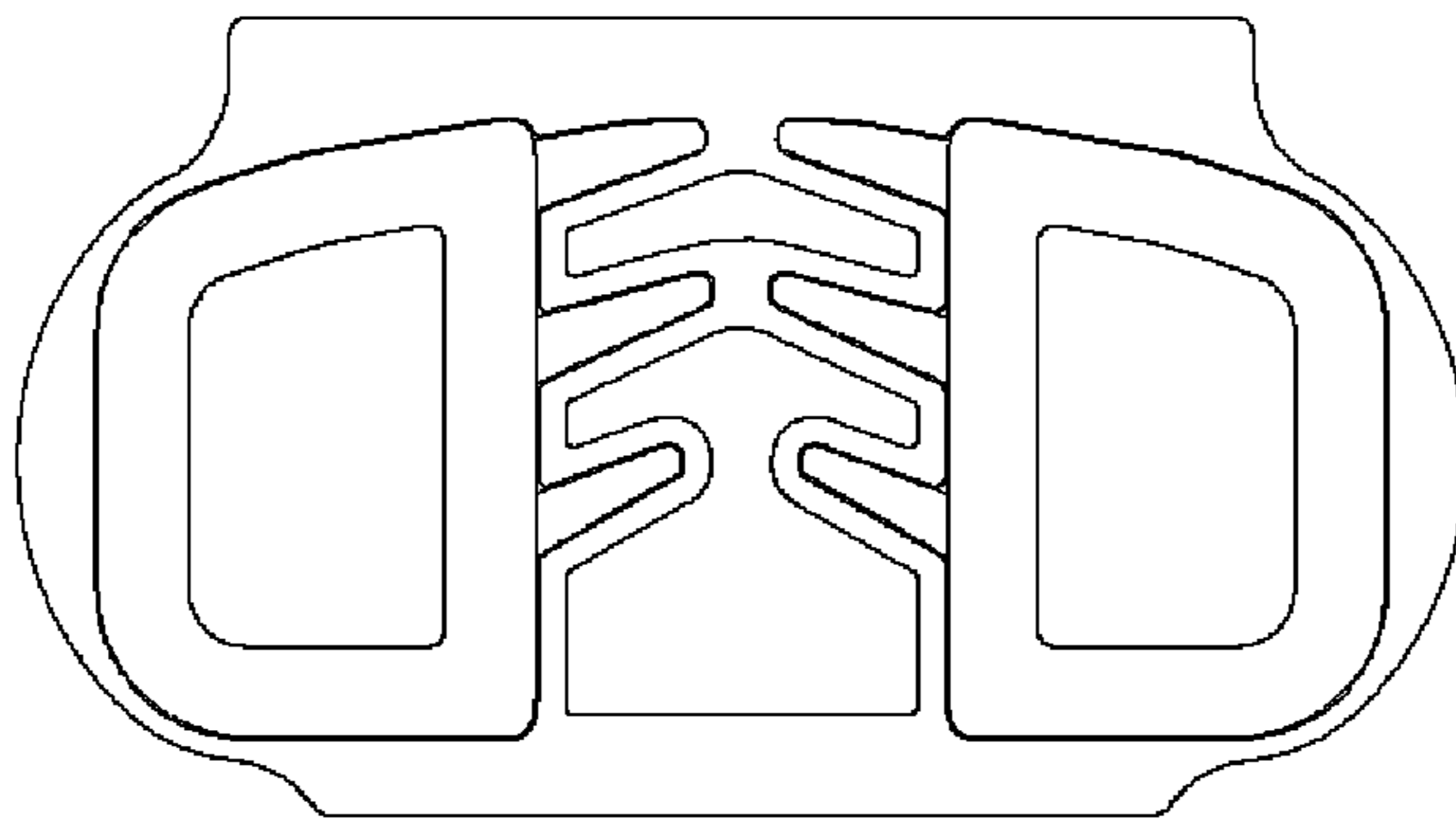

Fig. 5

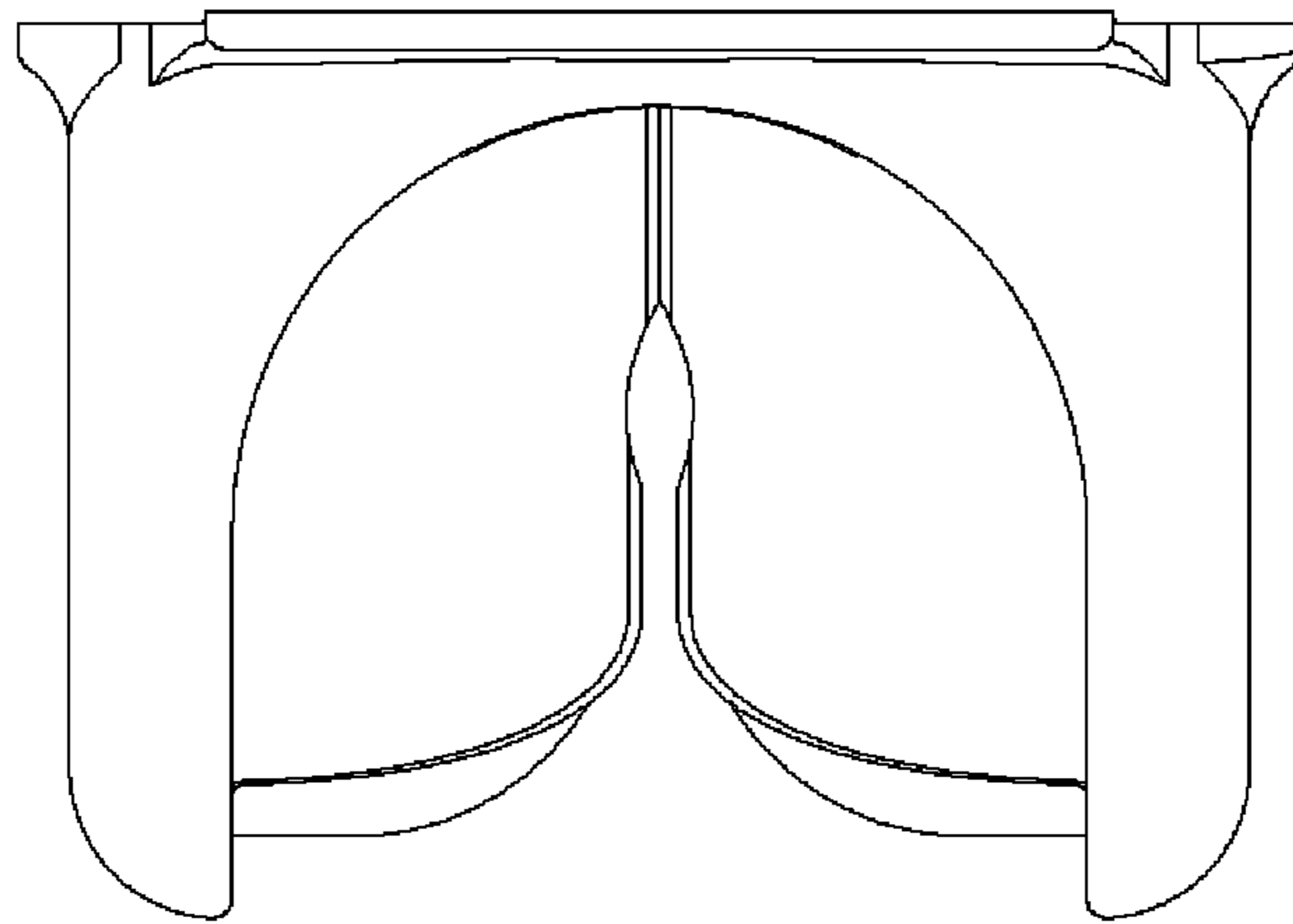

Fig 6.

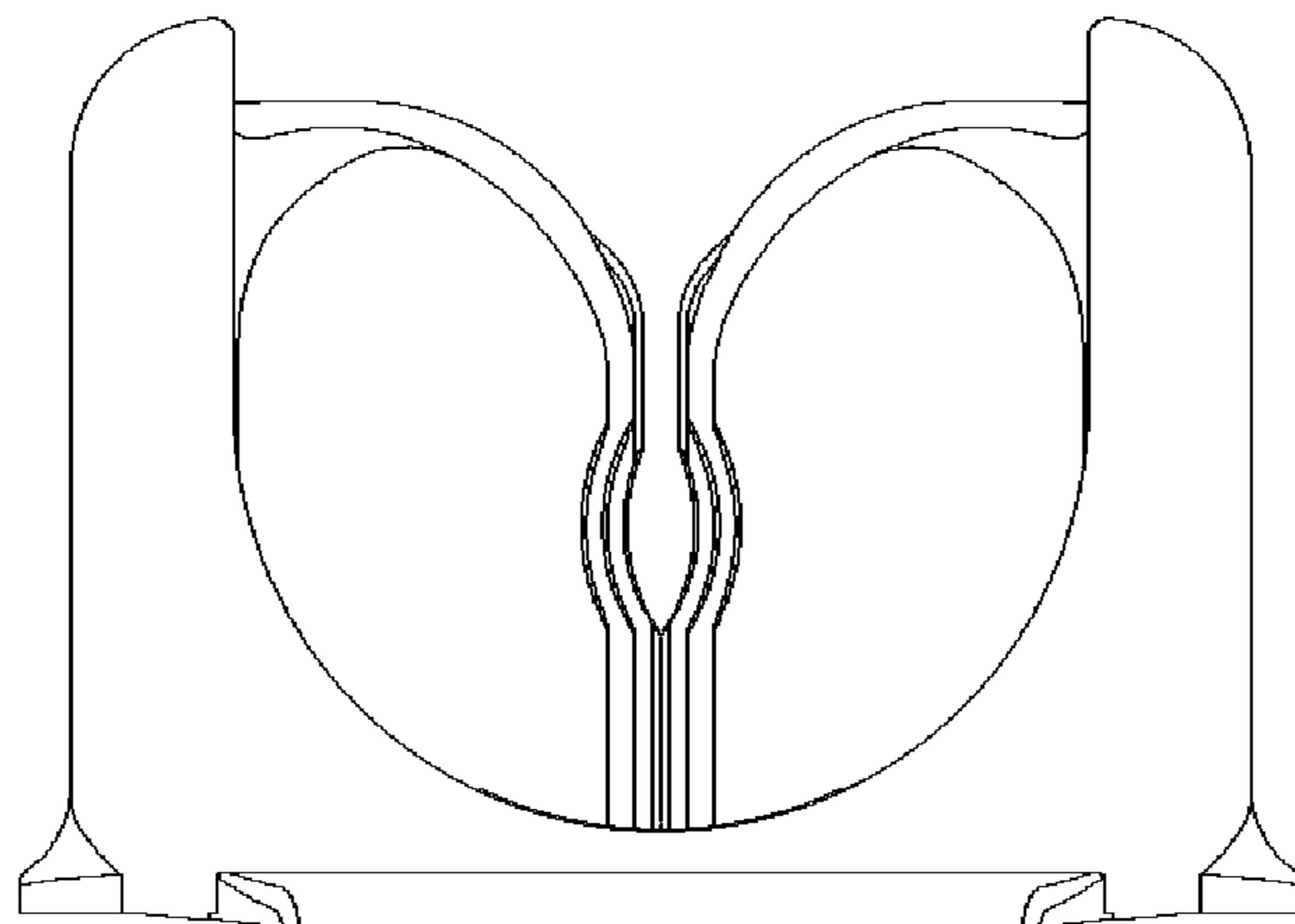

Fig. 7

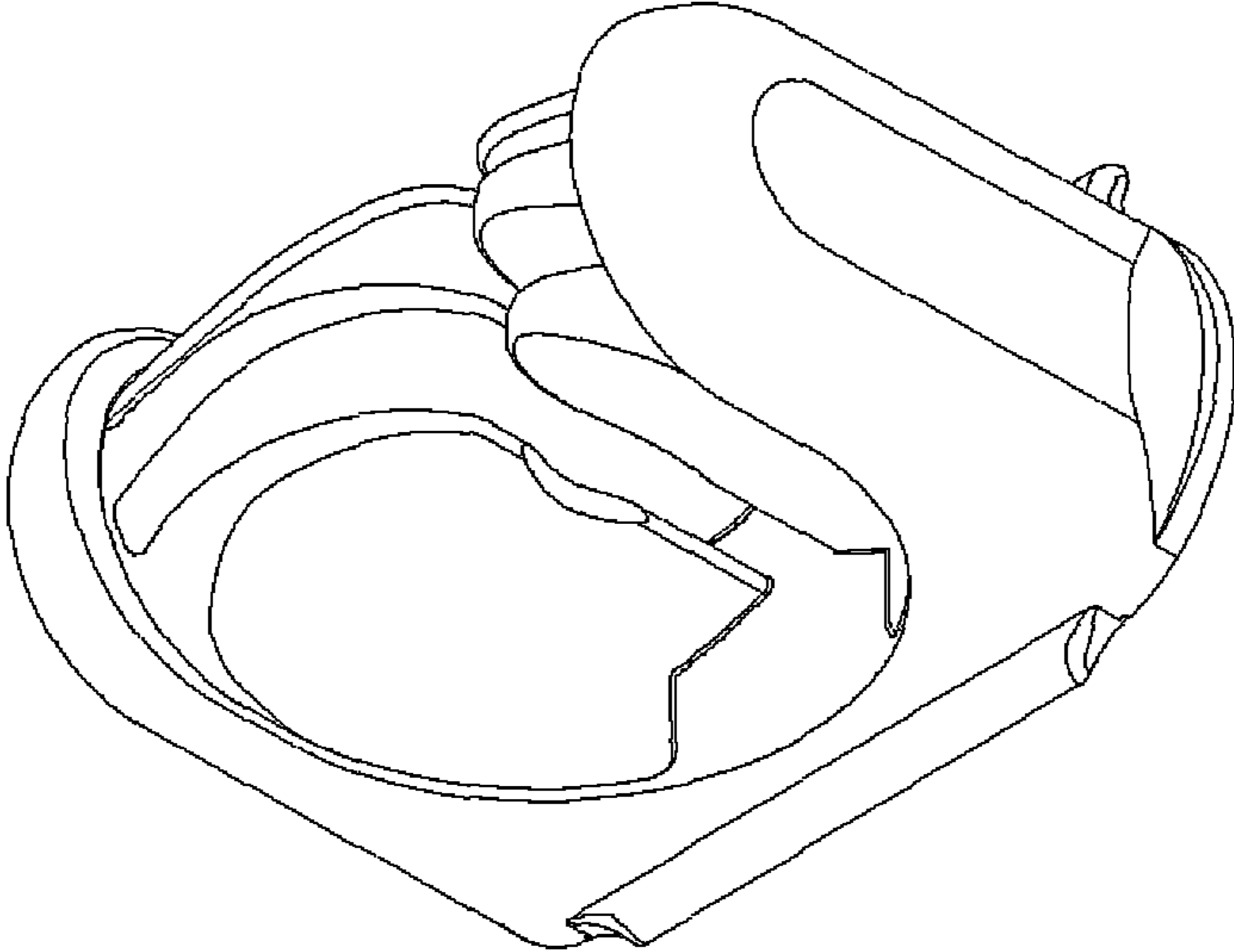

Fig. 8

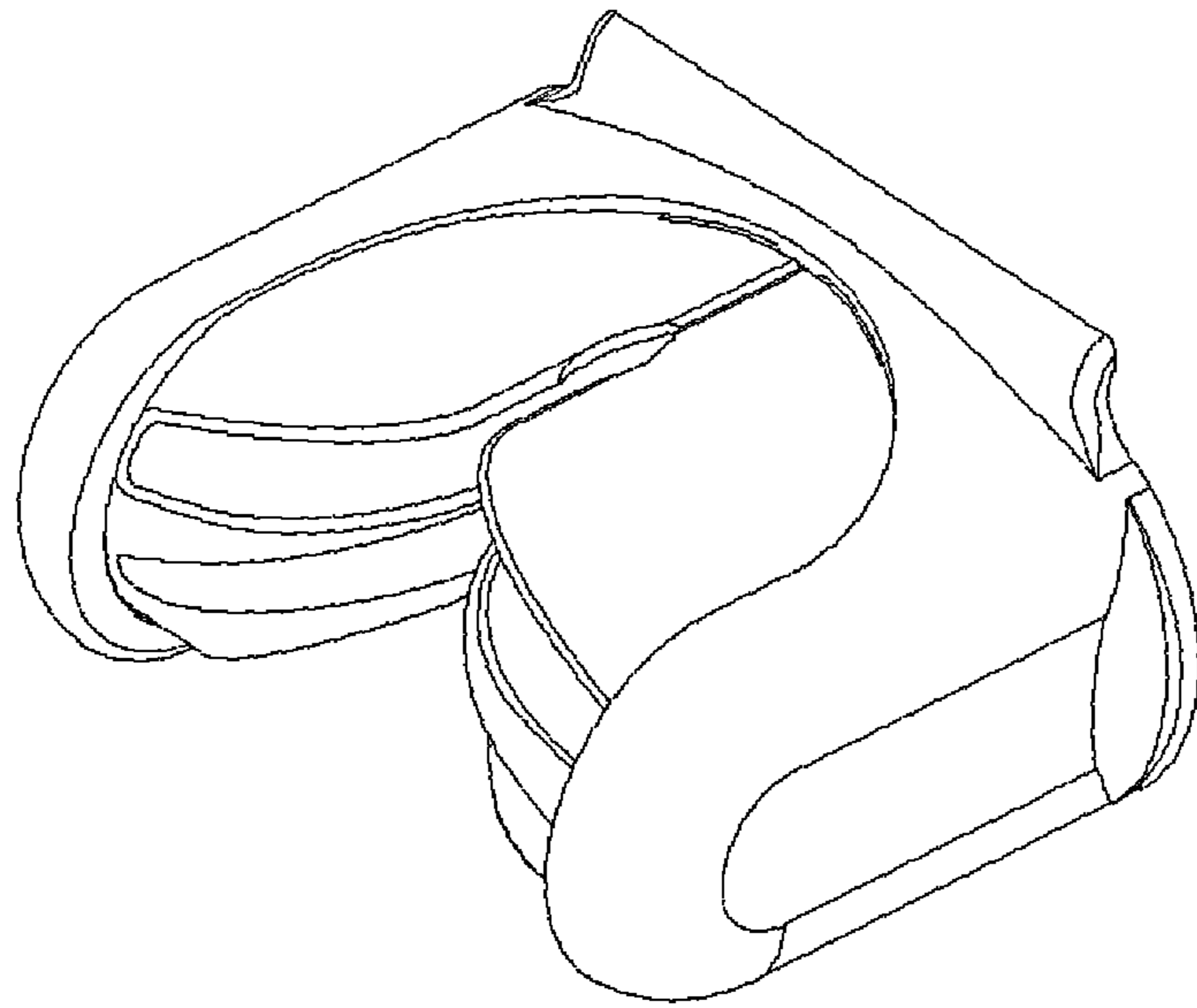

Fig. 9

