



US00D731793S

(12) **United States Design Patent**
Houghton et al.

(10) **Patent No.:** **US D731,793 S**
(45) **Date of Patent:** **** Jun. 16, 2015**

(54) **HEADSET CASE**

(71) Applicant: **Motorola Mobility LLC**, Libertyville, IL (US)

(72) Inventors: **Christopher B Houghton**, Chicago, IL (US); **Dickon Isaacs**, Chicago, IL (US); **William C Phelps, III**, Lawrenceville, GA (US); **Mark D Zaveson**, Antioch, IL (US)

(73) Assignee: **Motorola Mobility LLC**, Chicago, IL (US)

(**) Term: **14 Years**

(21) Appl. No.: **29/460,763**

(22) Filed: **Jul. 15, 2013**

(51) **LOC (10) Cl.** **03-01**

(52) **U.S. Cl.**
USPC **D3/294**

(58) **Field of Classification Search**
USPC D3/294, 201, 203.2, 203.3, 206, 261, D3/273, 295, 301-302, 901, 903, 904; D6/632, 634; D9/414-415, 420, D9/424-426, 428, 504; D28/82; 206/261, 206/320, 576; D14/205-206
See application file for complete search history.

(56) **References Cited**

U.S. PATENT DOCUMENTS

D281,033 S	*	10/1985	Mohri	D3/295
D595,262 S	*	6/2009	Nousiainen	D14/206
D620,256 S	*	7/2010	Fujimura et al.	D3/294
D629,202 S	*	12/2010	Wai	D3/294
D705,532 S	*	5/2014	Kolton	D3/201
D708,850 S	*	7/2014	Morine et al.	D3/294

OTHER PUBLICATIONS

Motorola, "Motorola Elite Sliver", Jul. 2, 2013, <http://www.motorola.com/us/consumers/Motorola-Elite-Sliver-Bluetooth%C2%AE-Headset>, 2 pages.

Christopher B. Houghton, et al, "Headset for a Communication Device", U.S. Appl. No. 29/459,626, filed Jul. 2, 2013, 27 pages.

* cited by examiner

Primary Examiner — Catheri Oliver-Garcia

(57) **CLAIM**

The ornamental design for a headset case, as shown and described.

DESCRIPTION

FIG. 1 is a front perspective view of a first embodiment of an ornamental design for a headset case;
FIG. 2 is a rear perspective view of the first embodiment thereof;
FIG. 3 is a top view of the first embodiment thereof;
FIG. 4 is a bottom view of the first embodiment thereof;
FIG. 5 is a first side view of the first embodiment thereof;
FIG. 6 is a second side view of the first embodiment thereof;
FIG. 7 is a front view of the first embodiment thereof; and
FIG. 8 is a rear view of the first embodiment thereof.
FIG. 9 is a front perspective view of a second embodiment of an ornamental design for a headset case;
FIG. 10 is a rear perspective view of the second embodiment thereof;
FIG. 11 is a top view of the second embodiment thereof;
FIG. 12 is a bottom view of the second embodiment thereof;
FIG. 13 is a first side view of the second embodiment thereof;
FIG. 14 is a second side view of the second embodiment thereof;
FIG. 15 is a front view of the second embodiment thereof; and
FIG. 16 is a rear view of the second embodiment thereof.
FIG. 17 is a front perspective view of the first embodiment shown in an open position;
FIG. 18 is a rear perspective view of the first embodiment shown in an open position;
FIG. 19 is a top view of the first embodiment shown in an open position;
FIG. 20 is a bottom view of the first embodiment shown in an open position;
FIG. 21 is a first side view of the first embodiment shown in an open position;

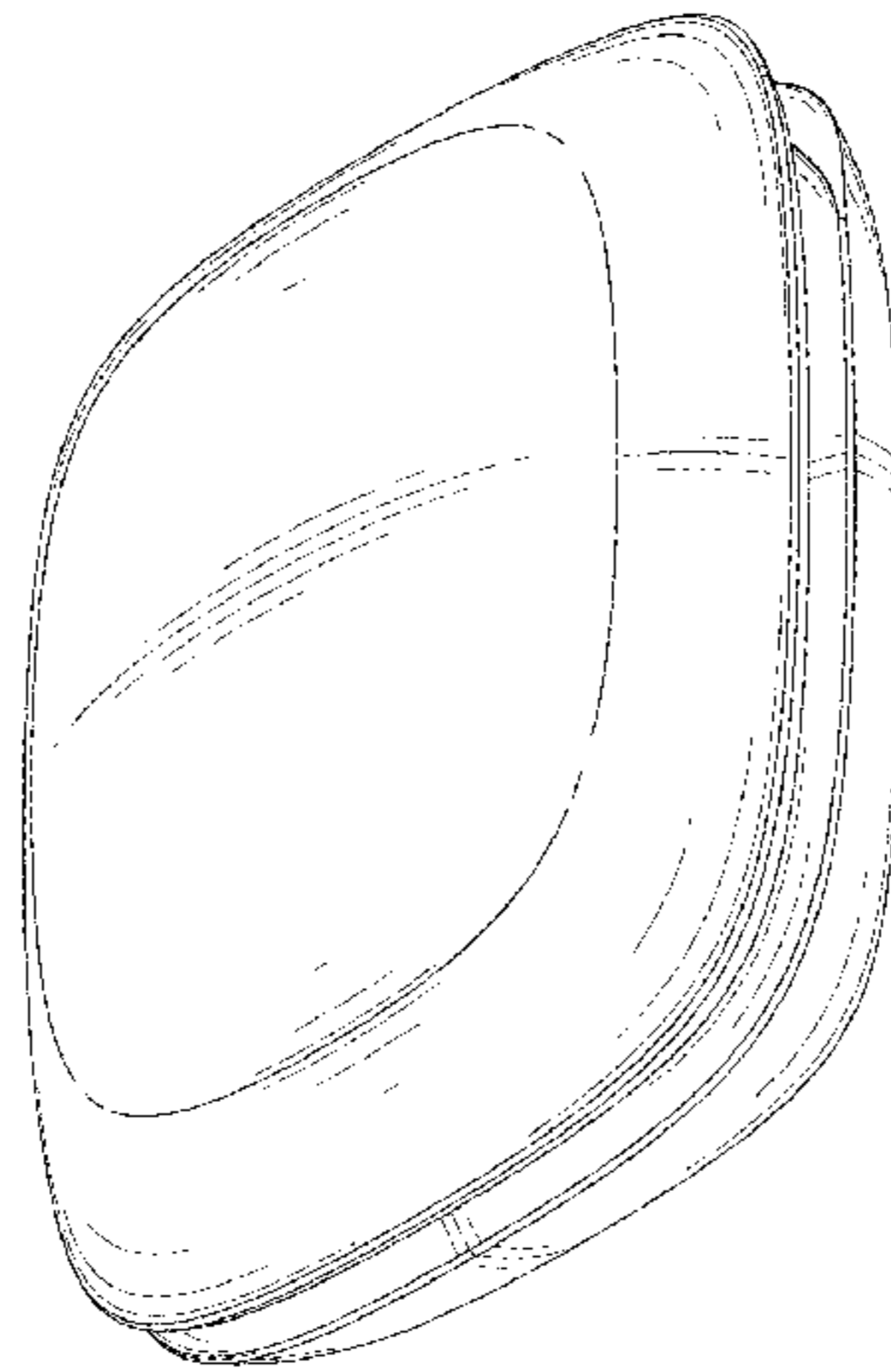

FIG. **22** is a second side view of the first embodiment shown in an open position;

FIG. **23** is a front view of the first embodiment shown in an open position;

FIG. **24** is a rear view of the first embodiment shown in an open position;

FIG. **25** is a front perspective view of the second embodiment shown in an open position;

FIG. **26** is a rear perspective view of the second embodiment shown in an open position;

FIG. **27** is a top view of the second embodiment shown in an open position;

FIG. **28** is a bottom view of the second embodiment shown in an open position;

FIG. **29** is a first side view of the second embodiment shown in an open position;

FIG. **30** is a second side view of the second embodiment shown in an open position;

FIG. **31** is a front view of the second embodiment shown in an open position; and,

FIG. **32** is a rear view of the second embodiment shown in an open position.

The broken lines shown in FIGS. **9-16** and **25-32** that are immediately adjacent to the shaded areas, and define unshaded regions, represent the bounds of the second and fourth embodiments, while all other broken lines are directed to environment and are for illustrative purposes only; the broken lines form no part of the second and fourth embodiments.

1 Claim, 28 Drawing Sheets

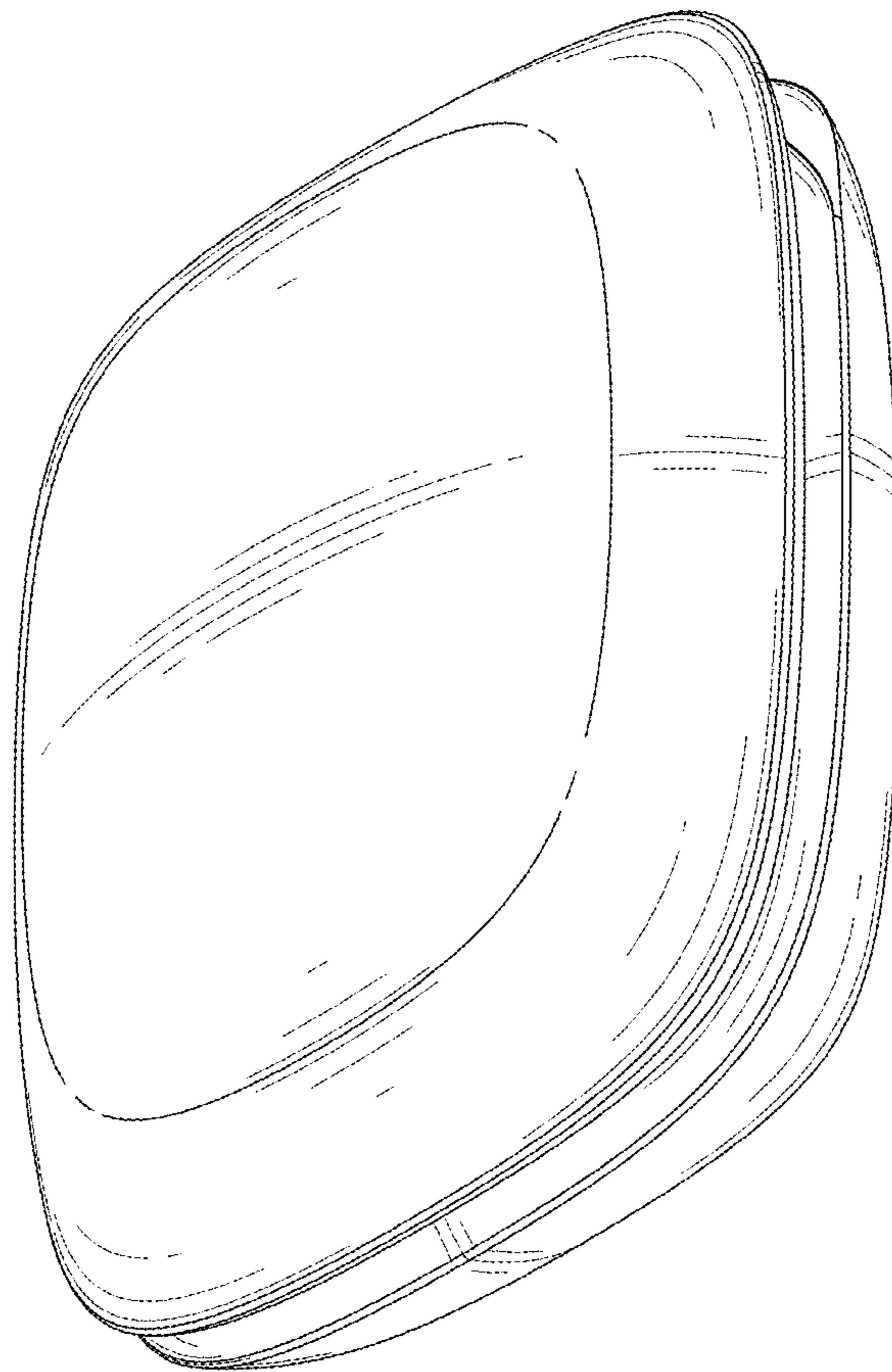

FIG. 1

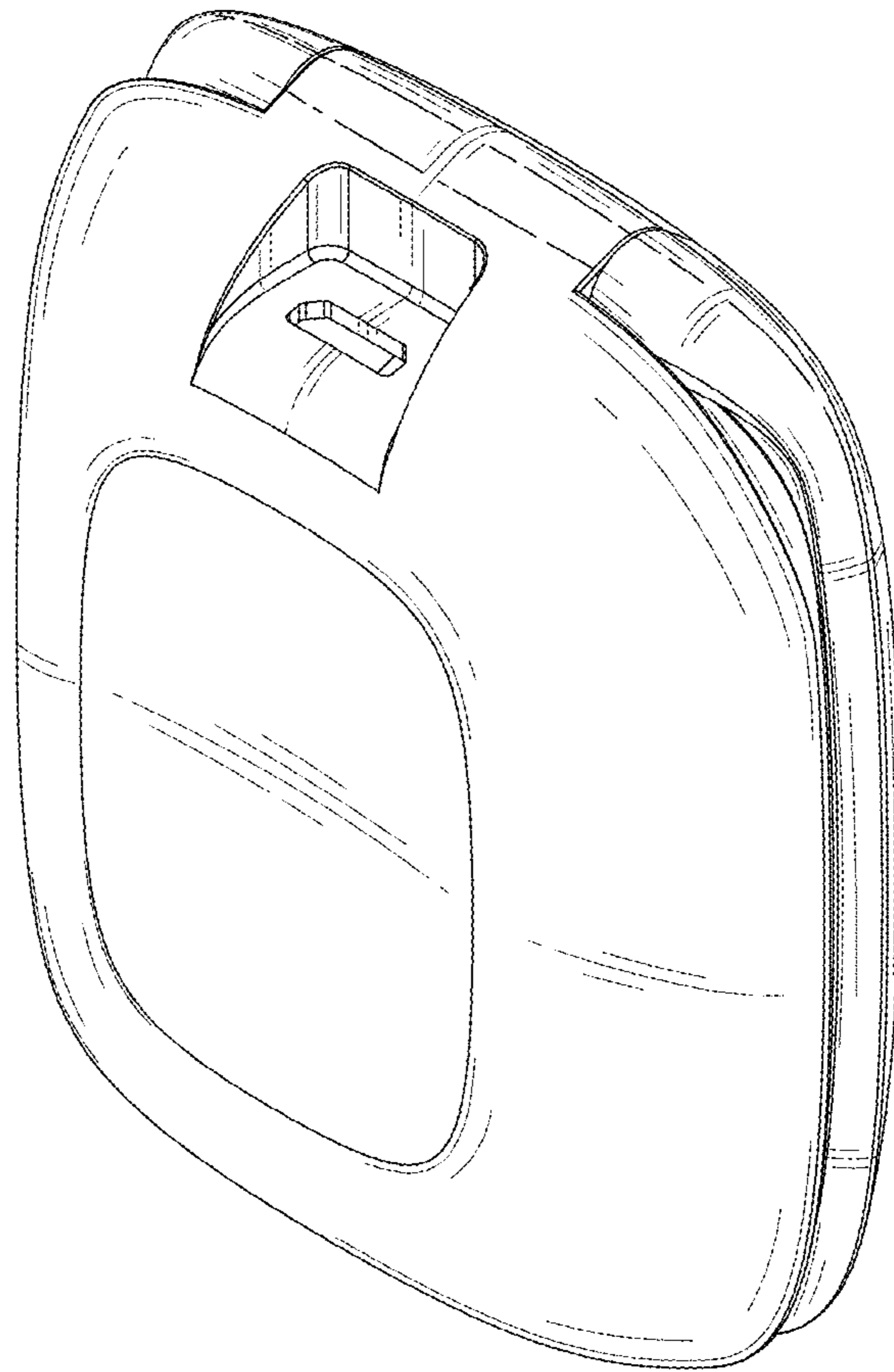

FIG. 2

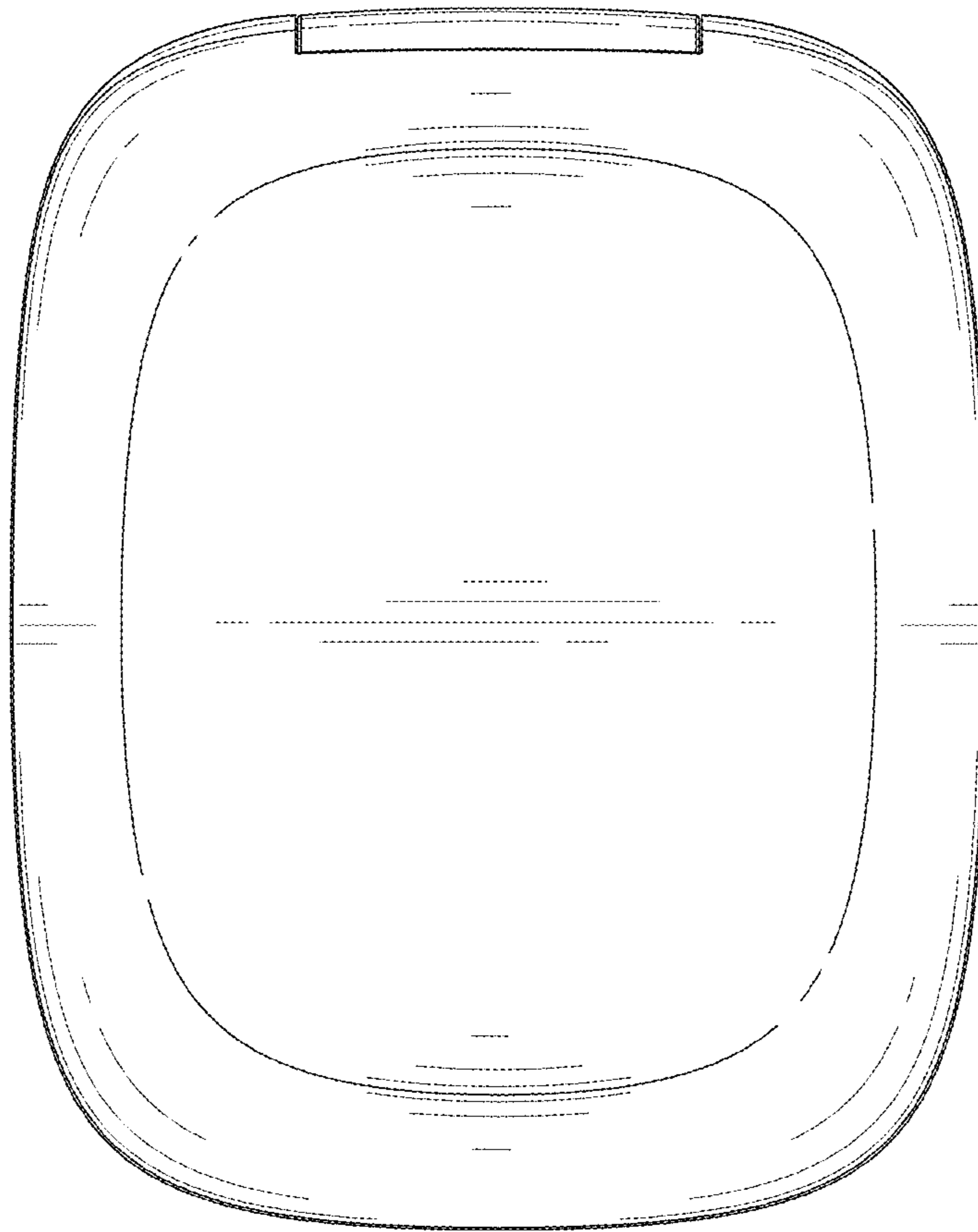

FIG. 3

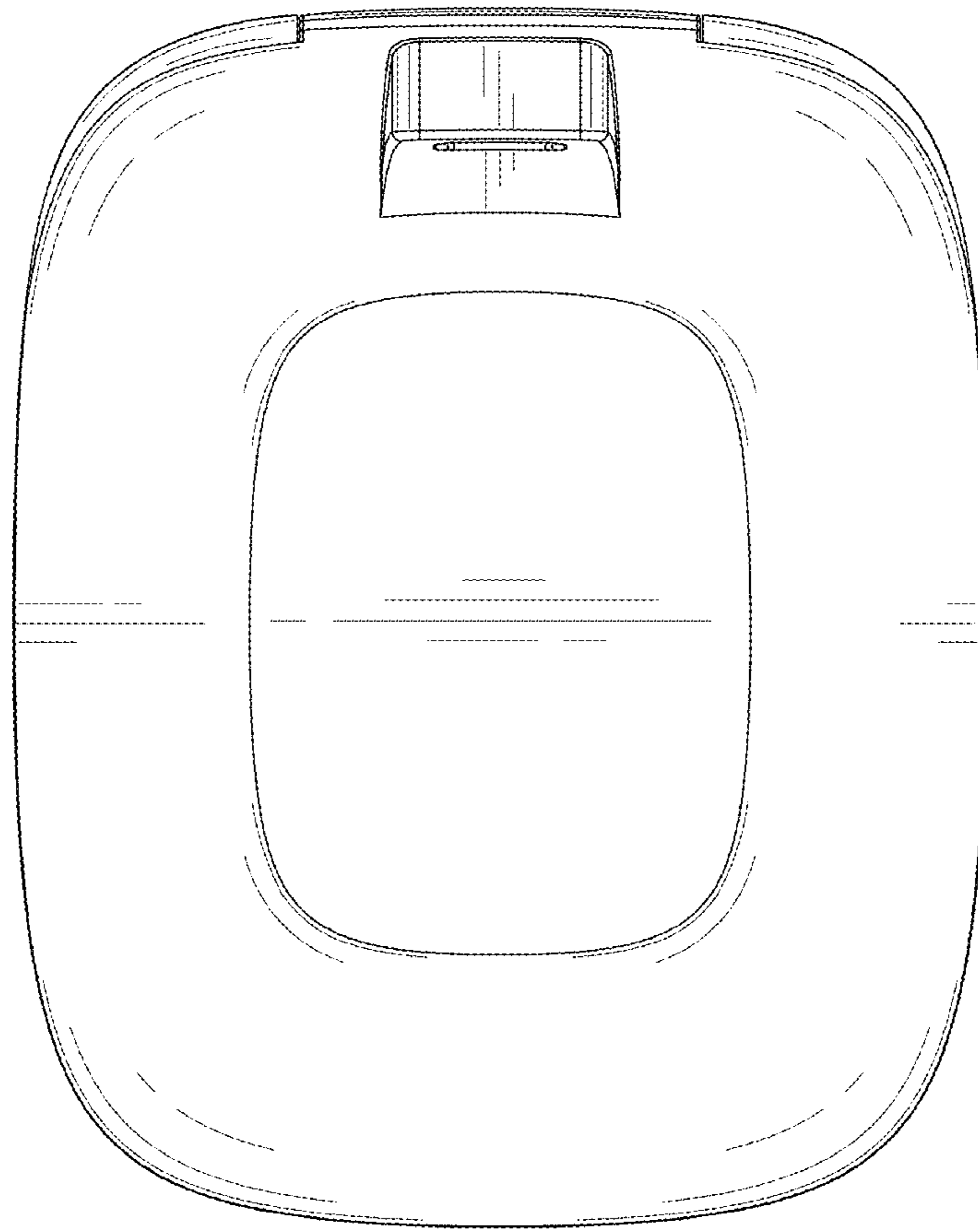

FIG. 4

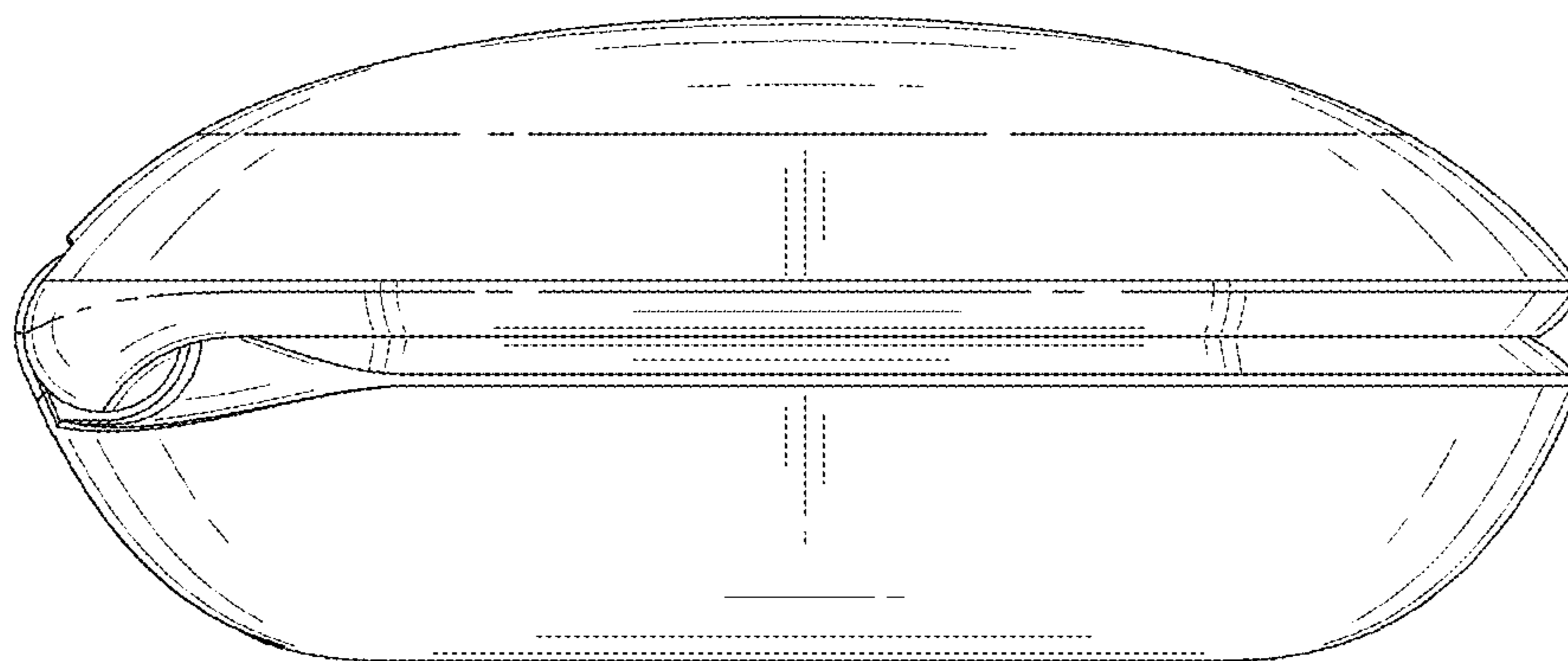

FIG. 5

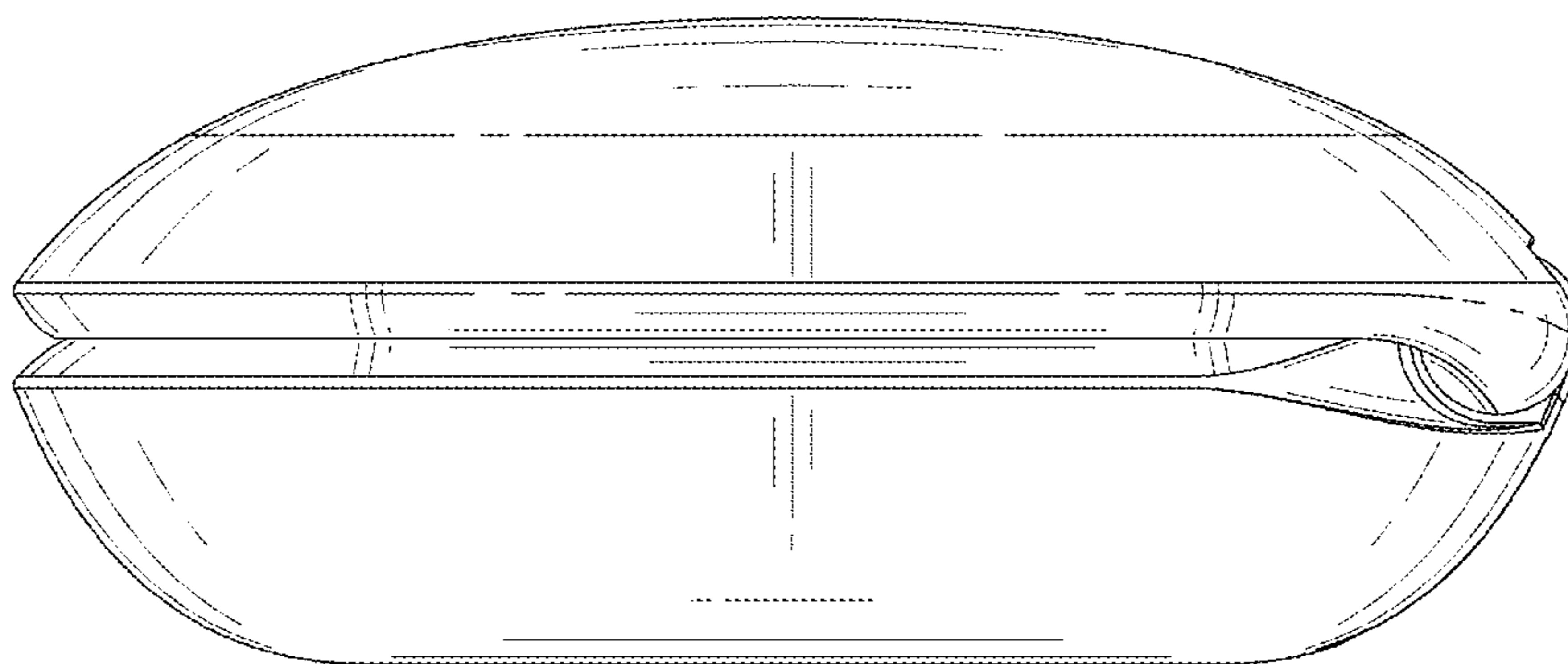

FIG. 6

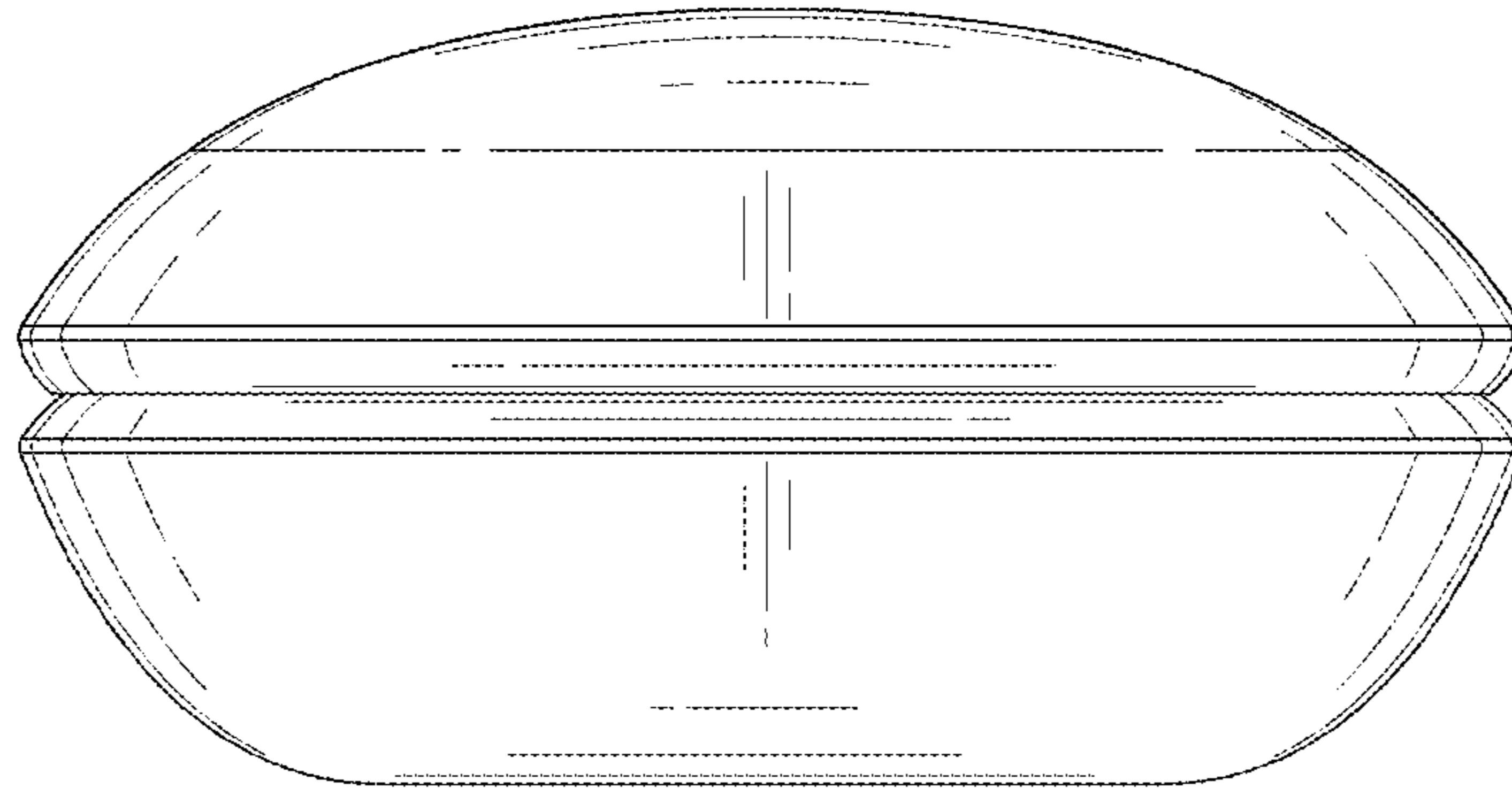

FIG. 7

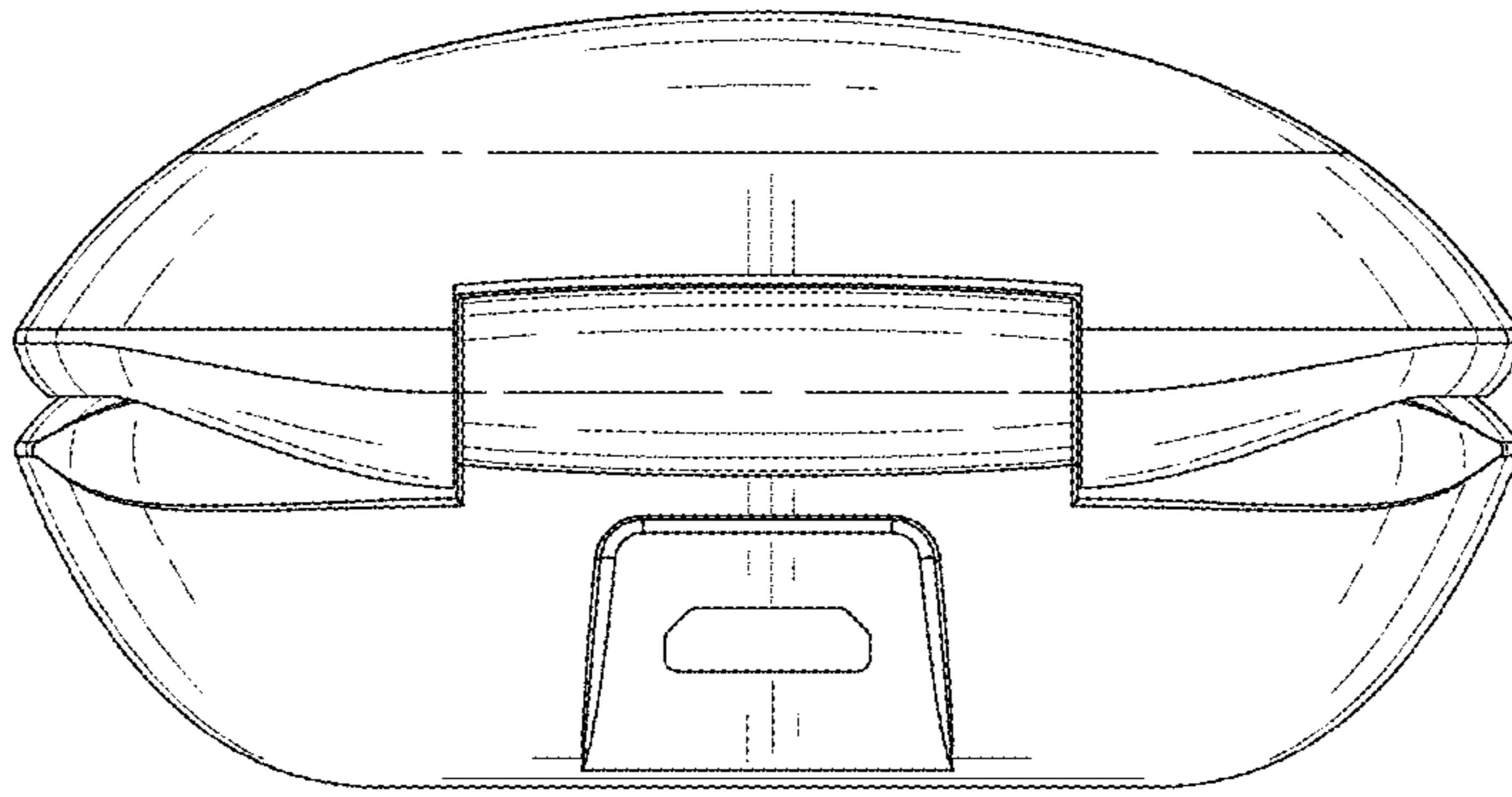

FIG. 8

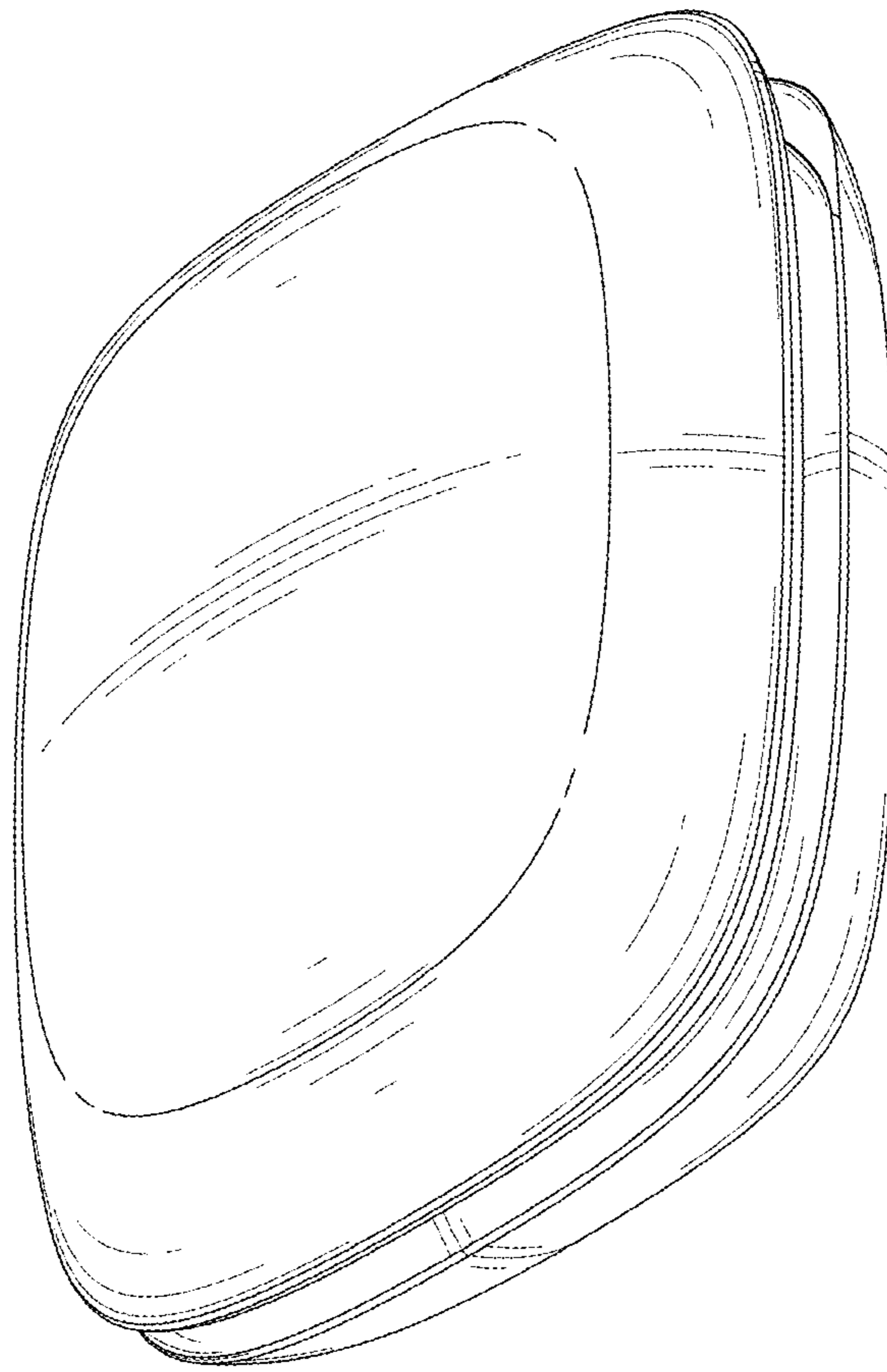

FIG. 9

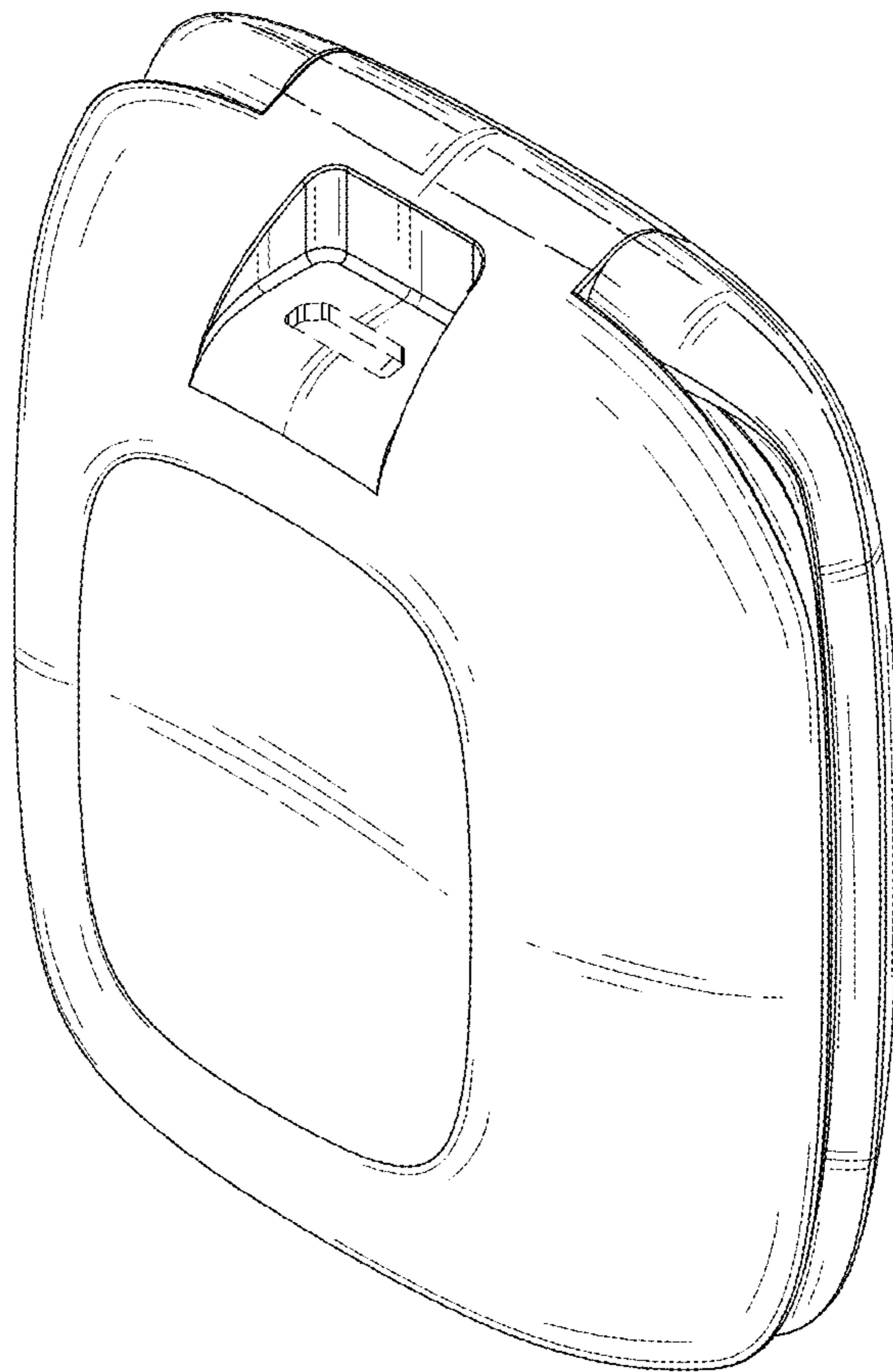

FIG. 10

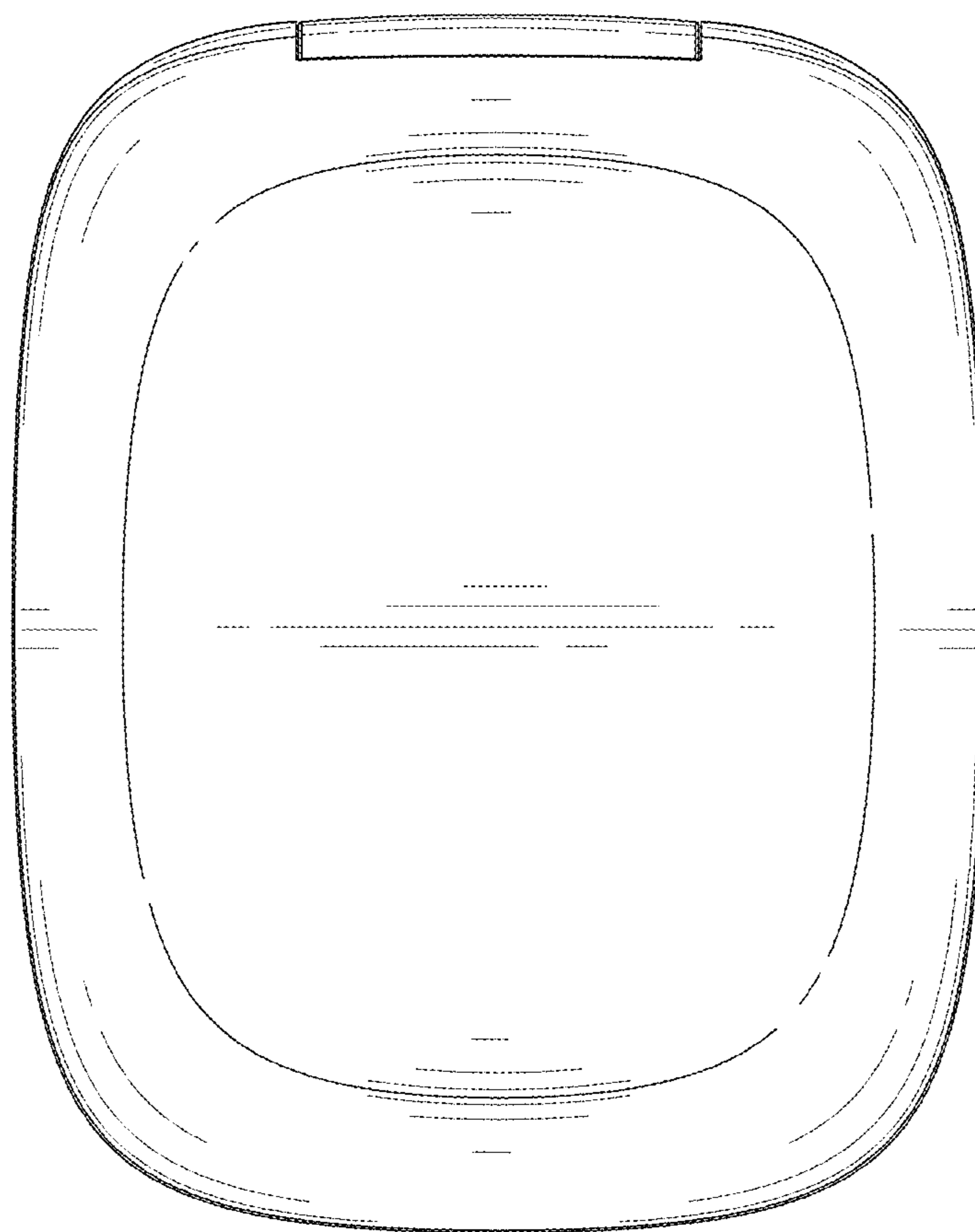

FIG. 11

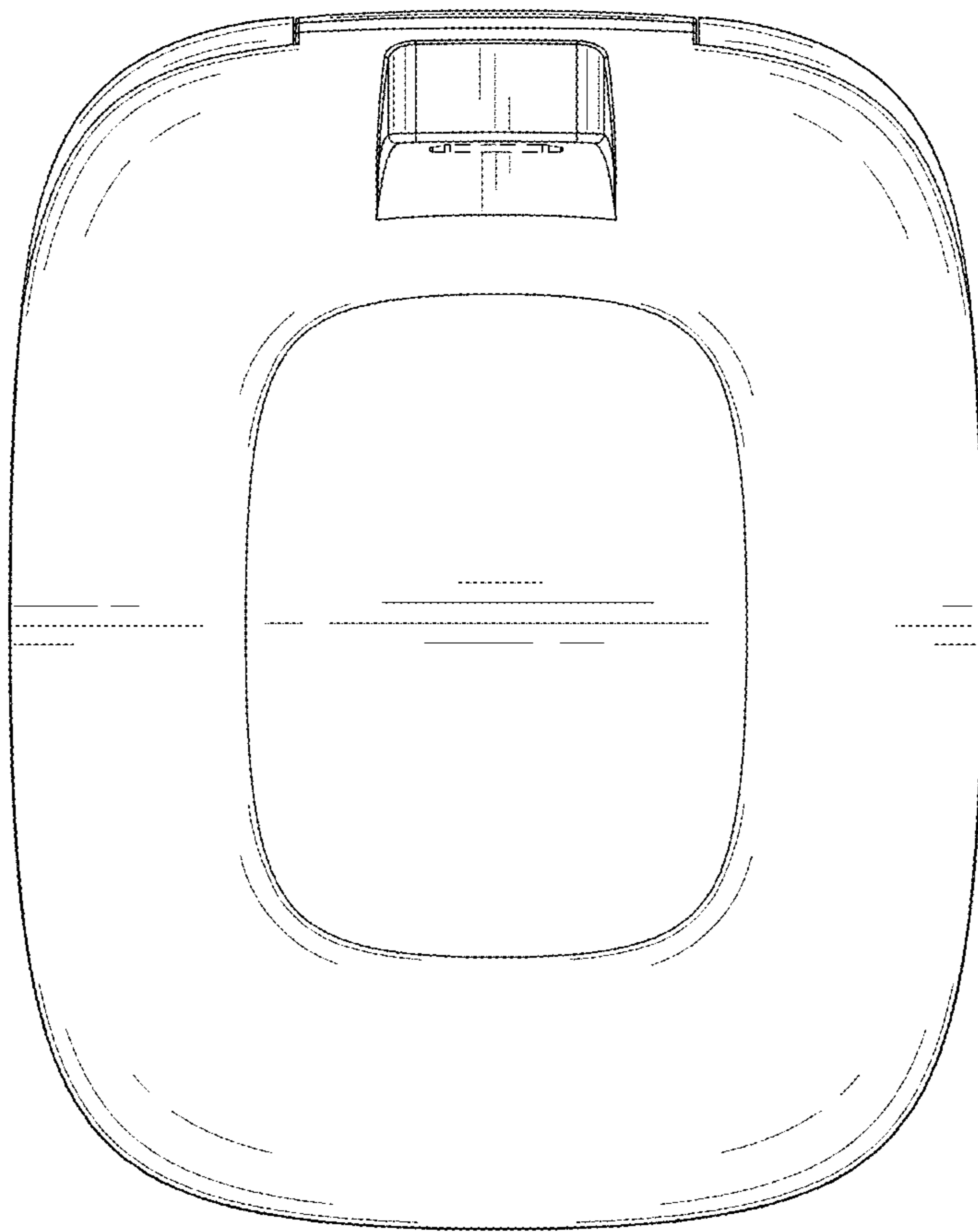

FIG. 12

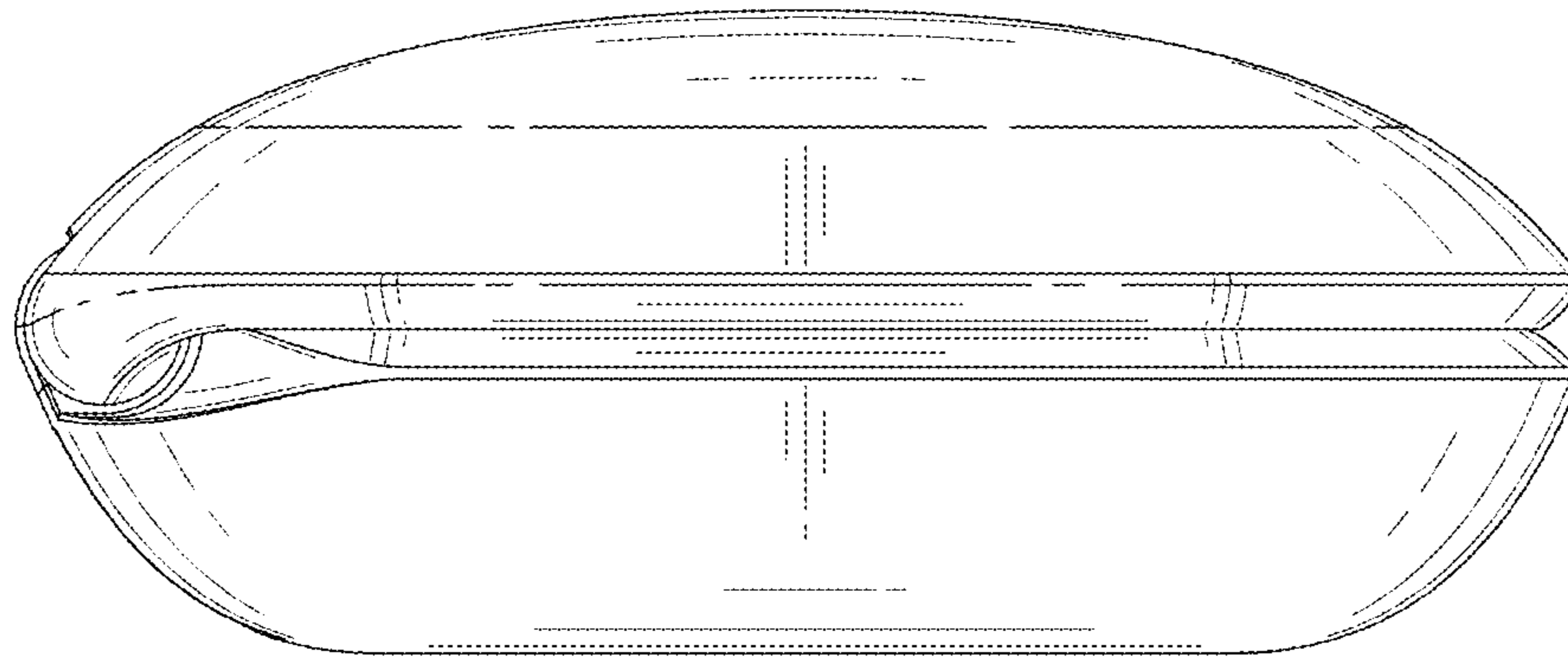

FIG. 13

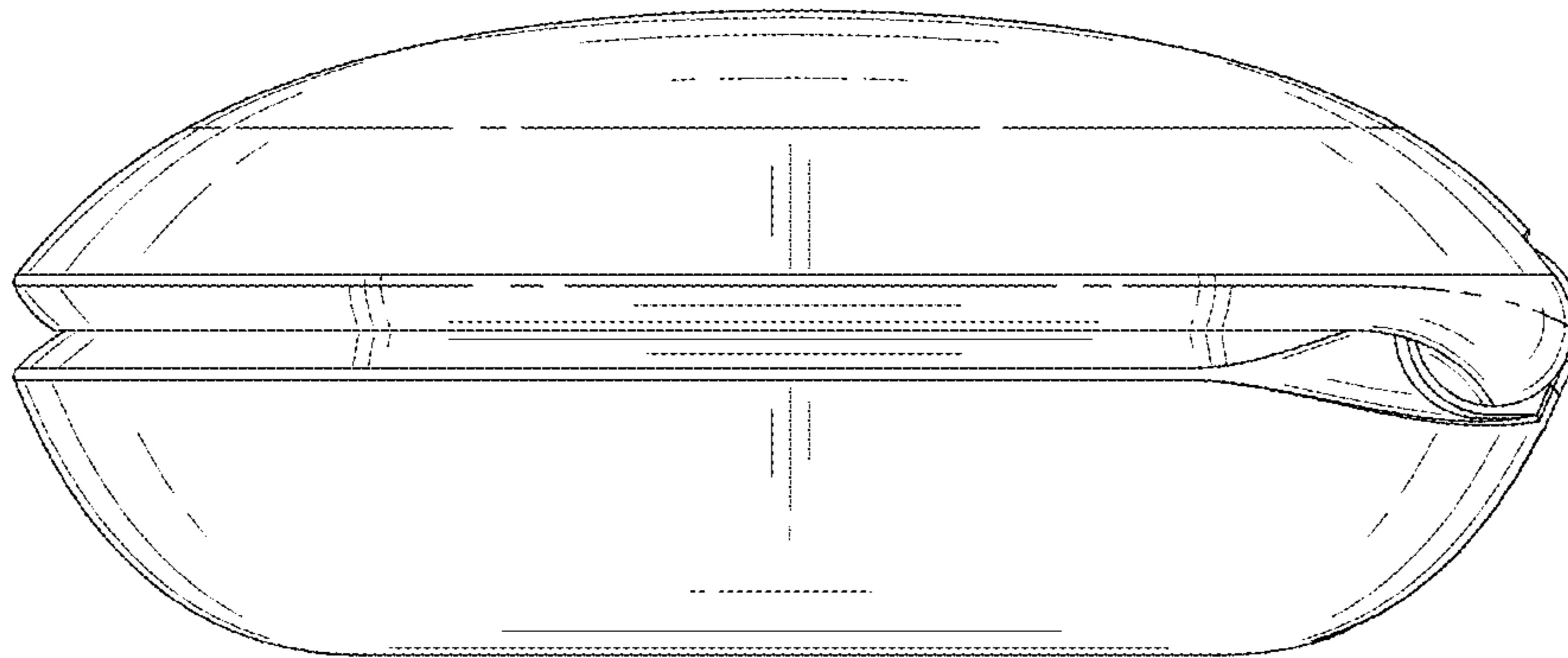

FIG. 14

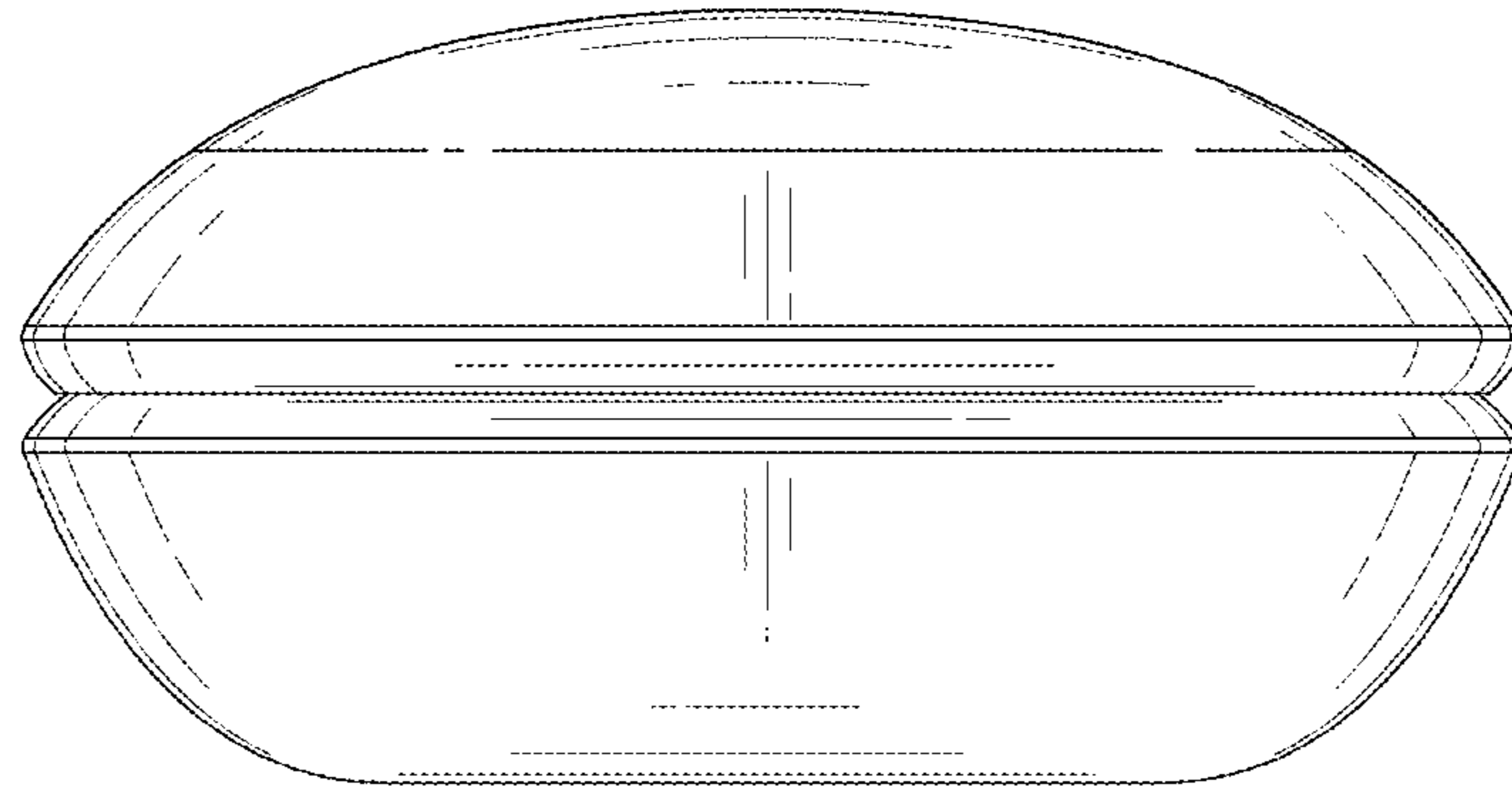

FIG. 15

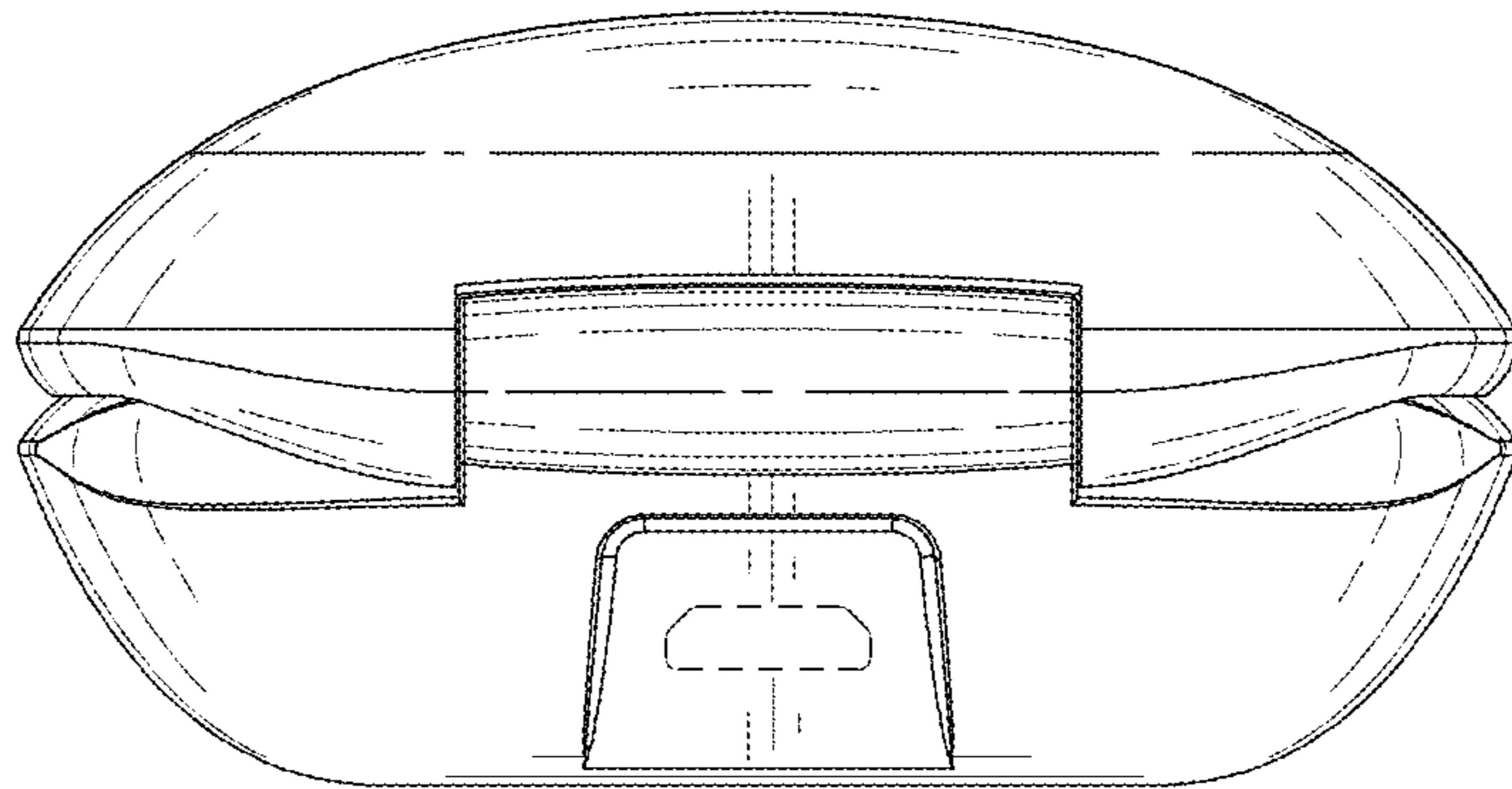

FIG. 16

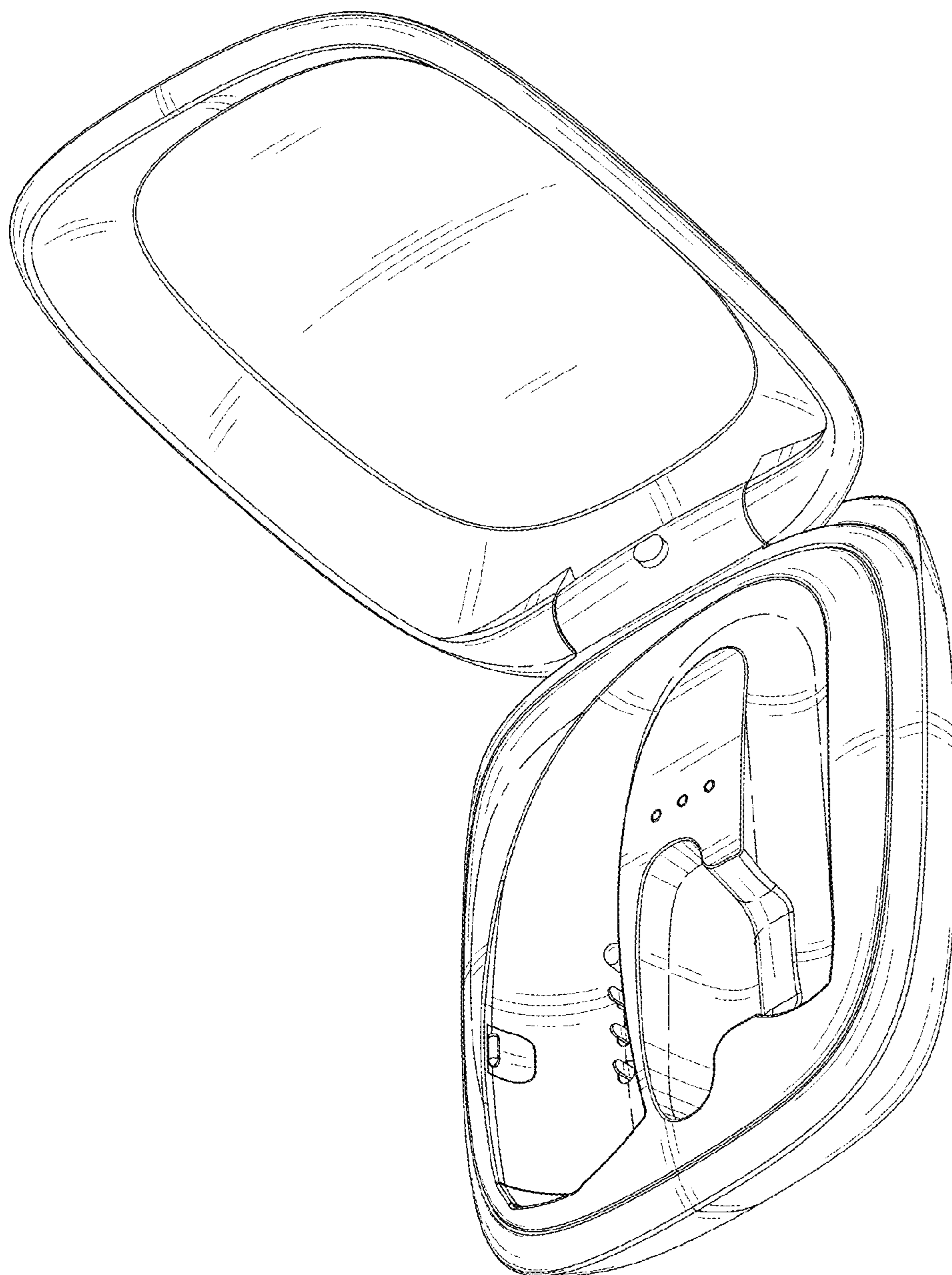

FIG. 17

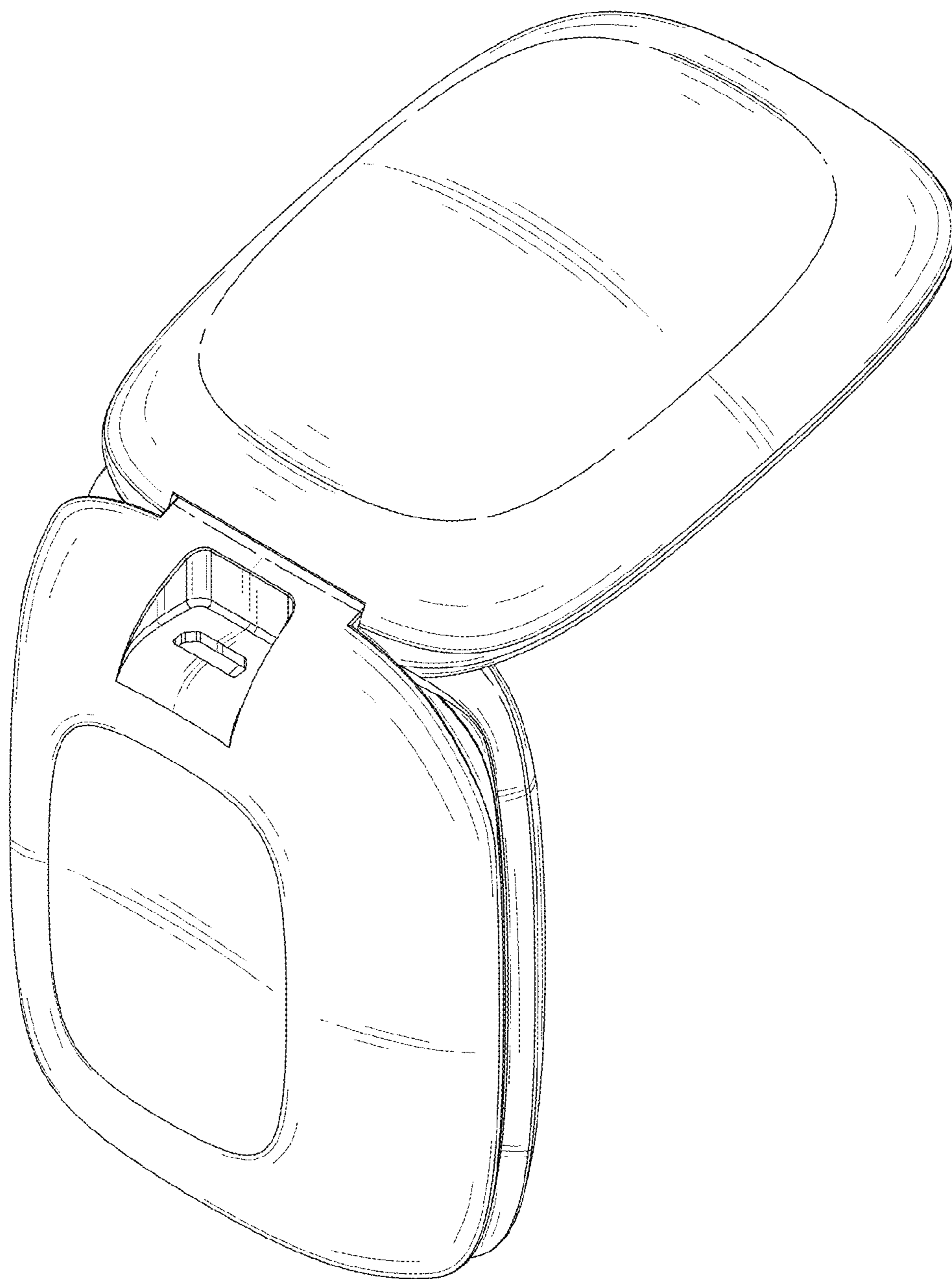

FIG. 18

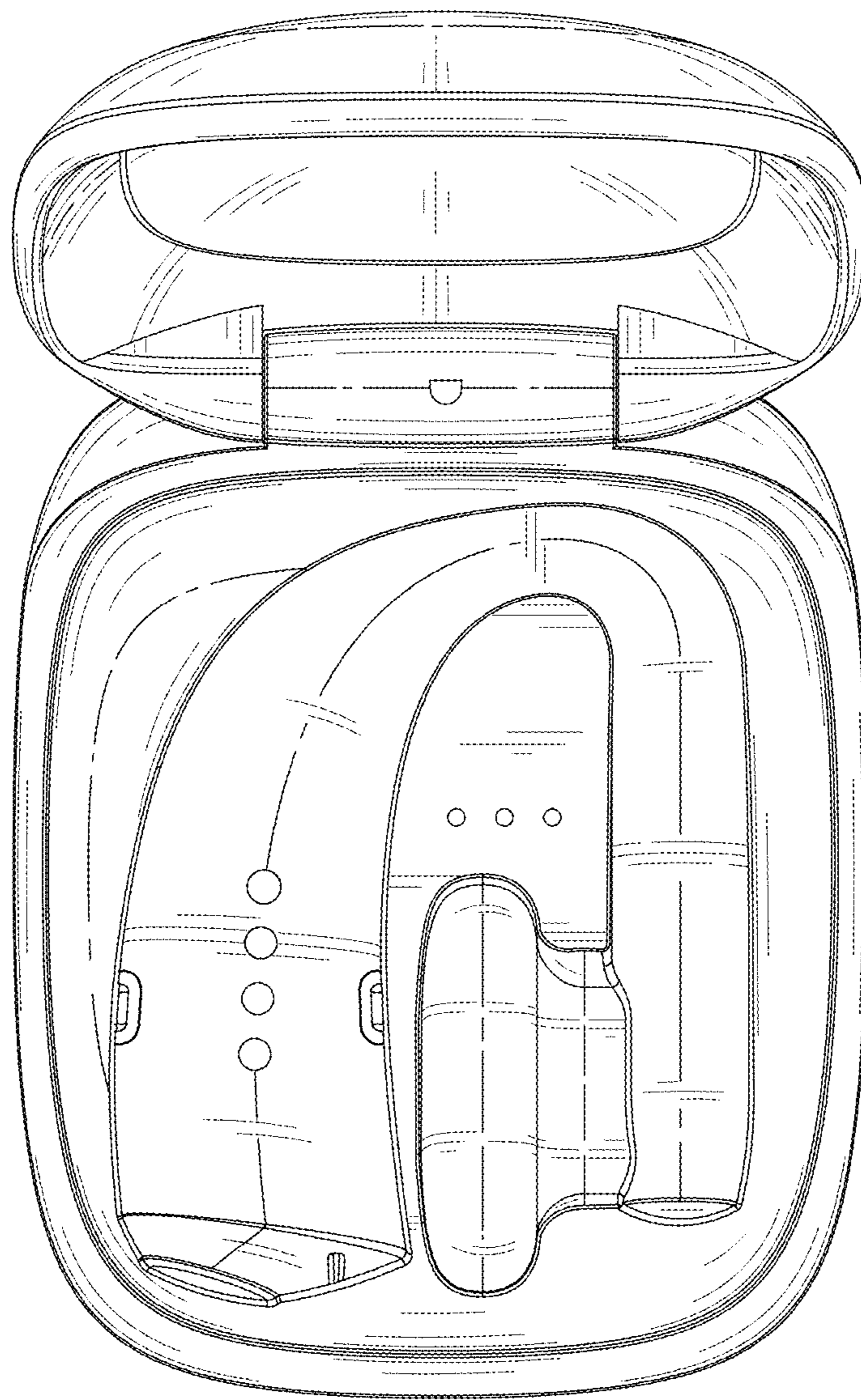

FIG. 19

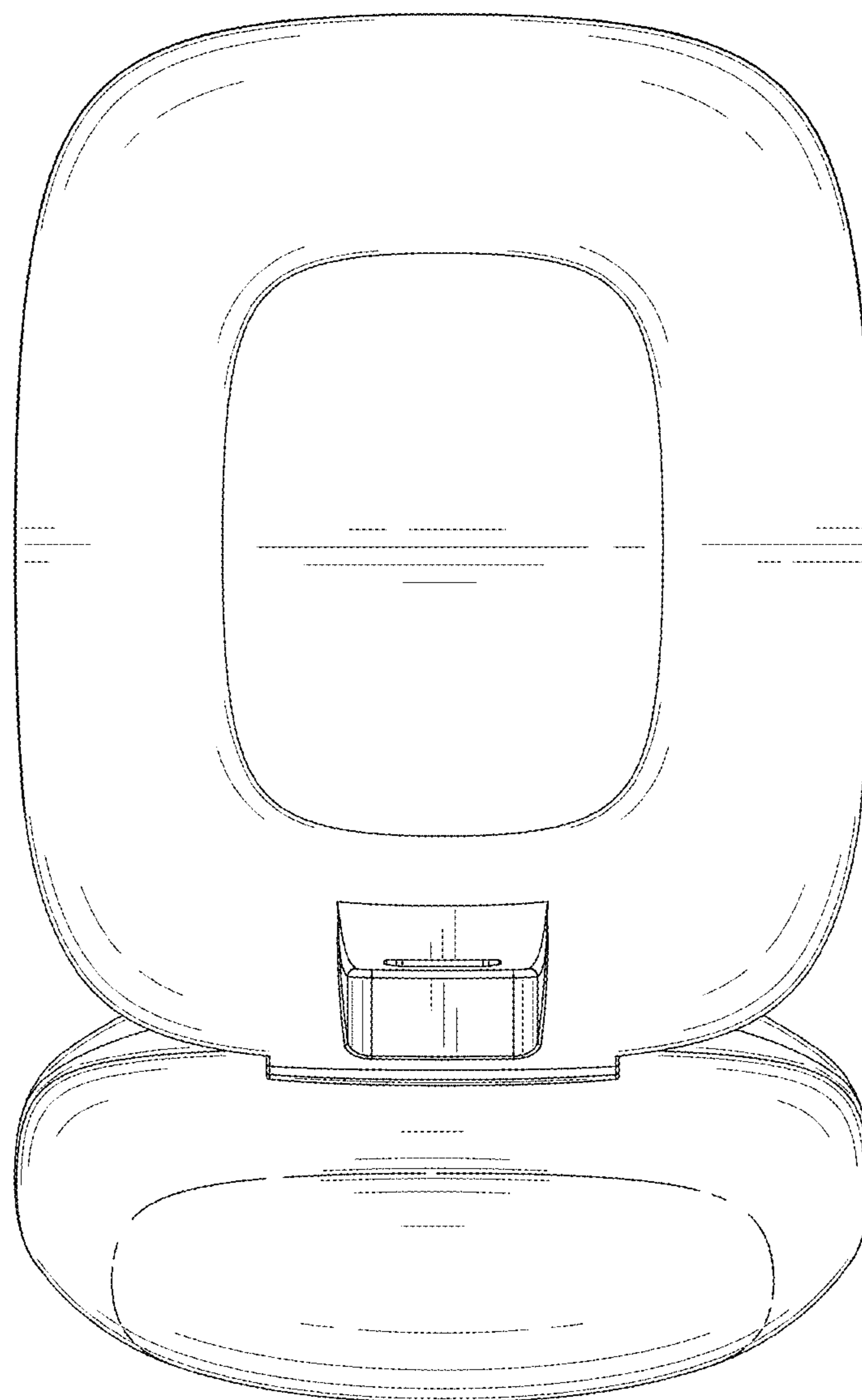

FIG. 20

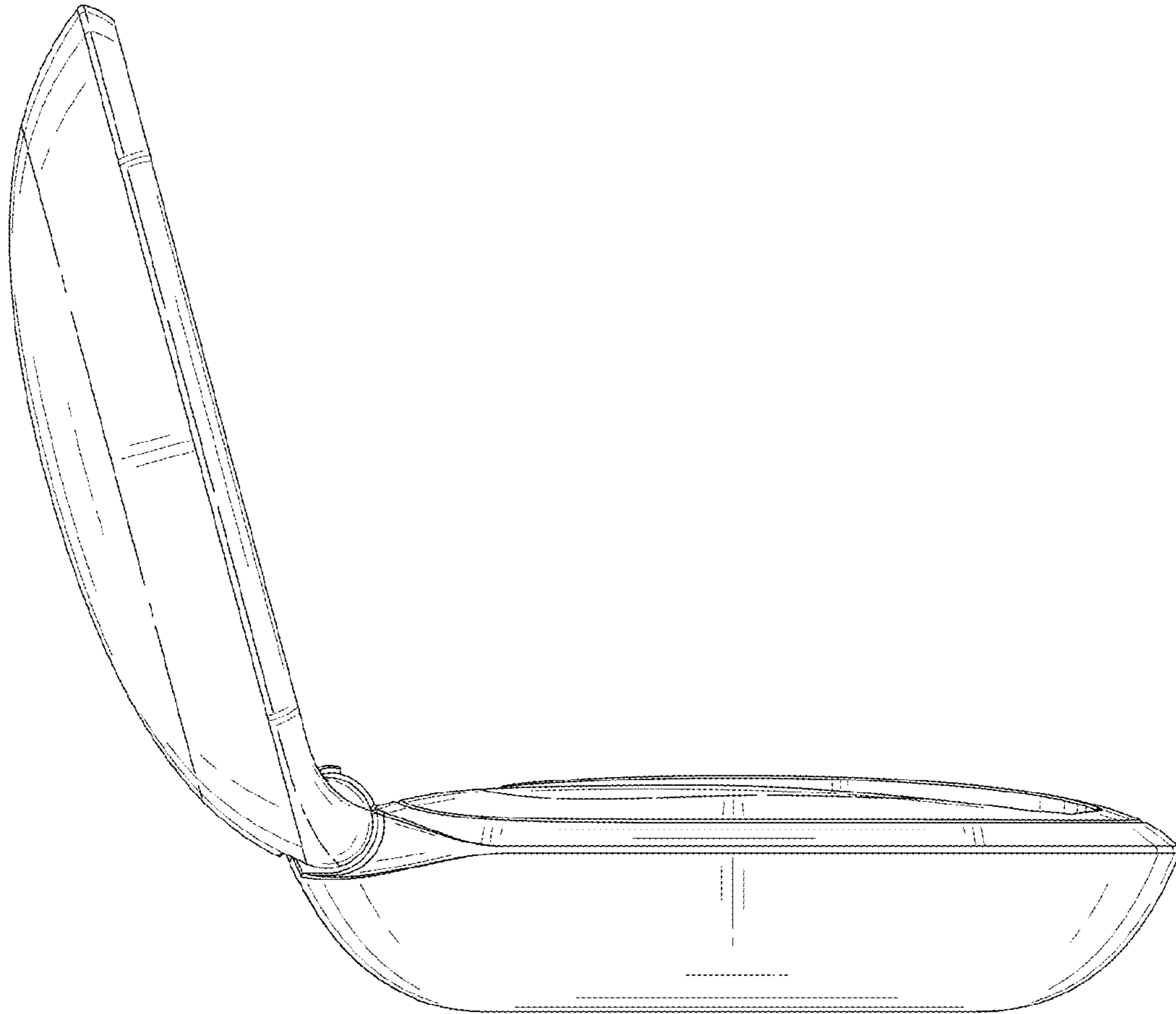

FIG. 21

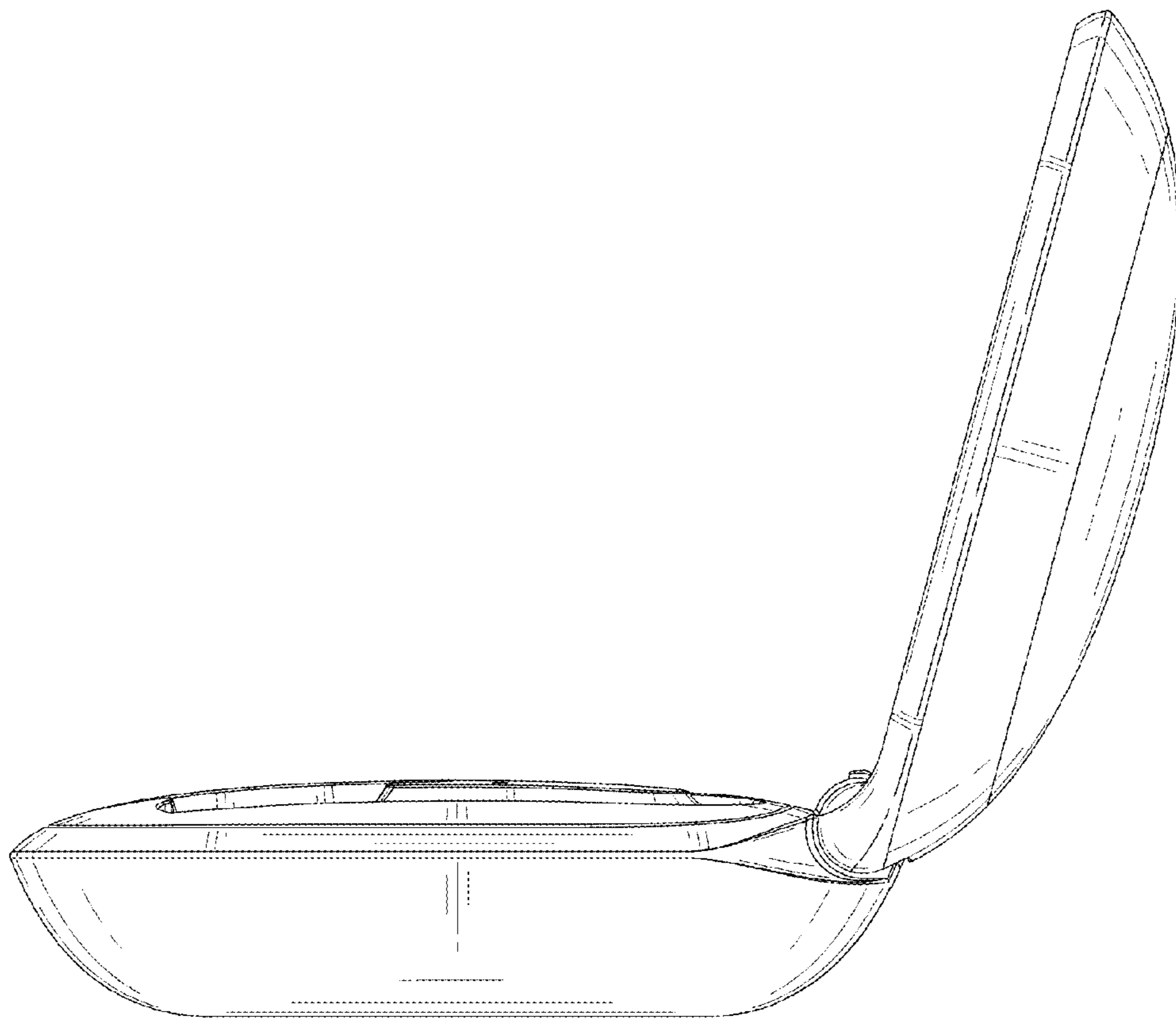

FIG. 22

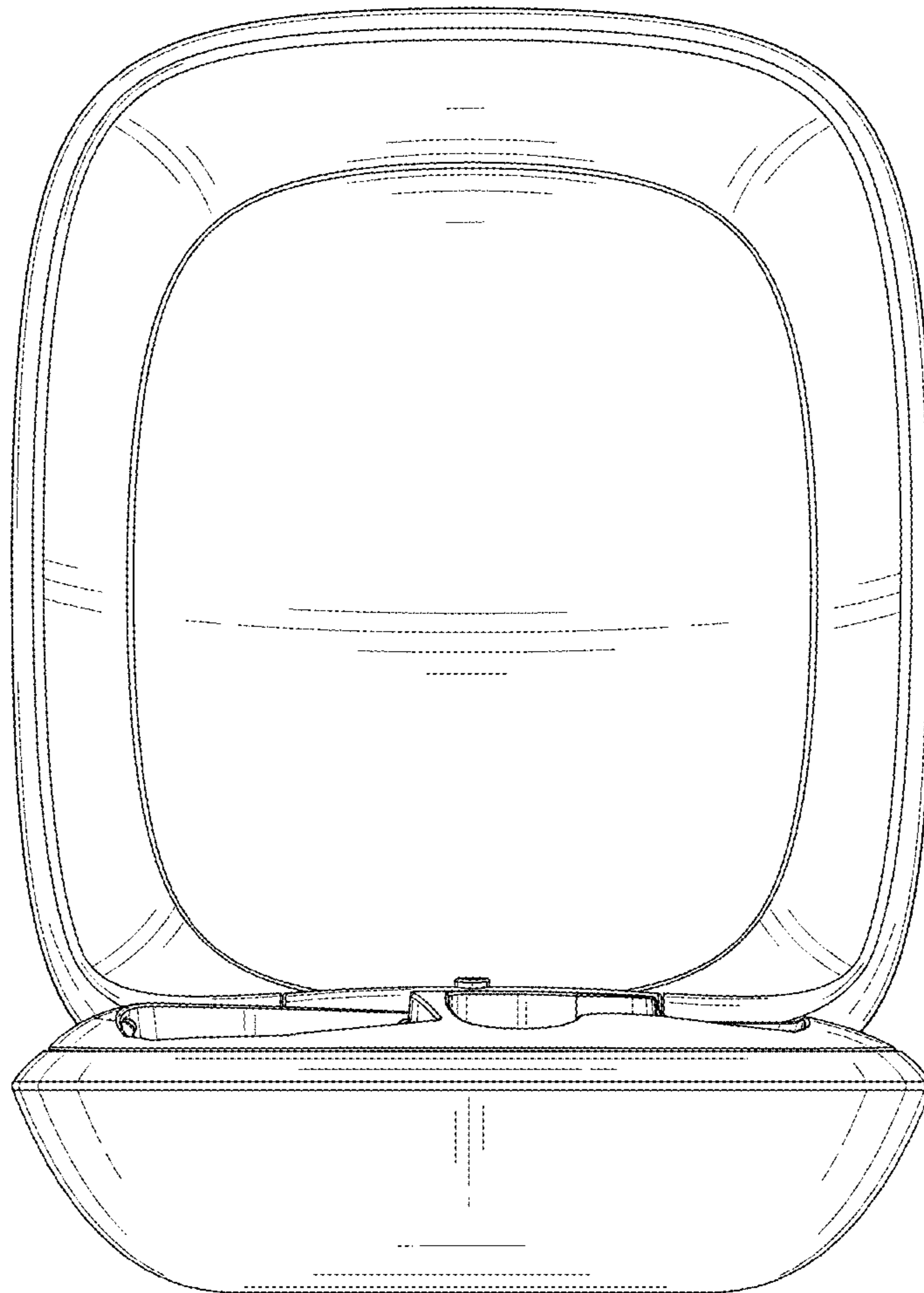

FIG. 23

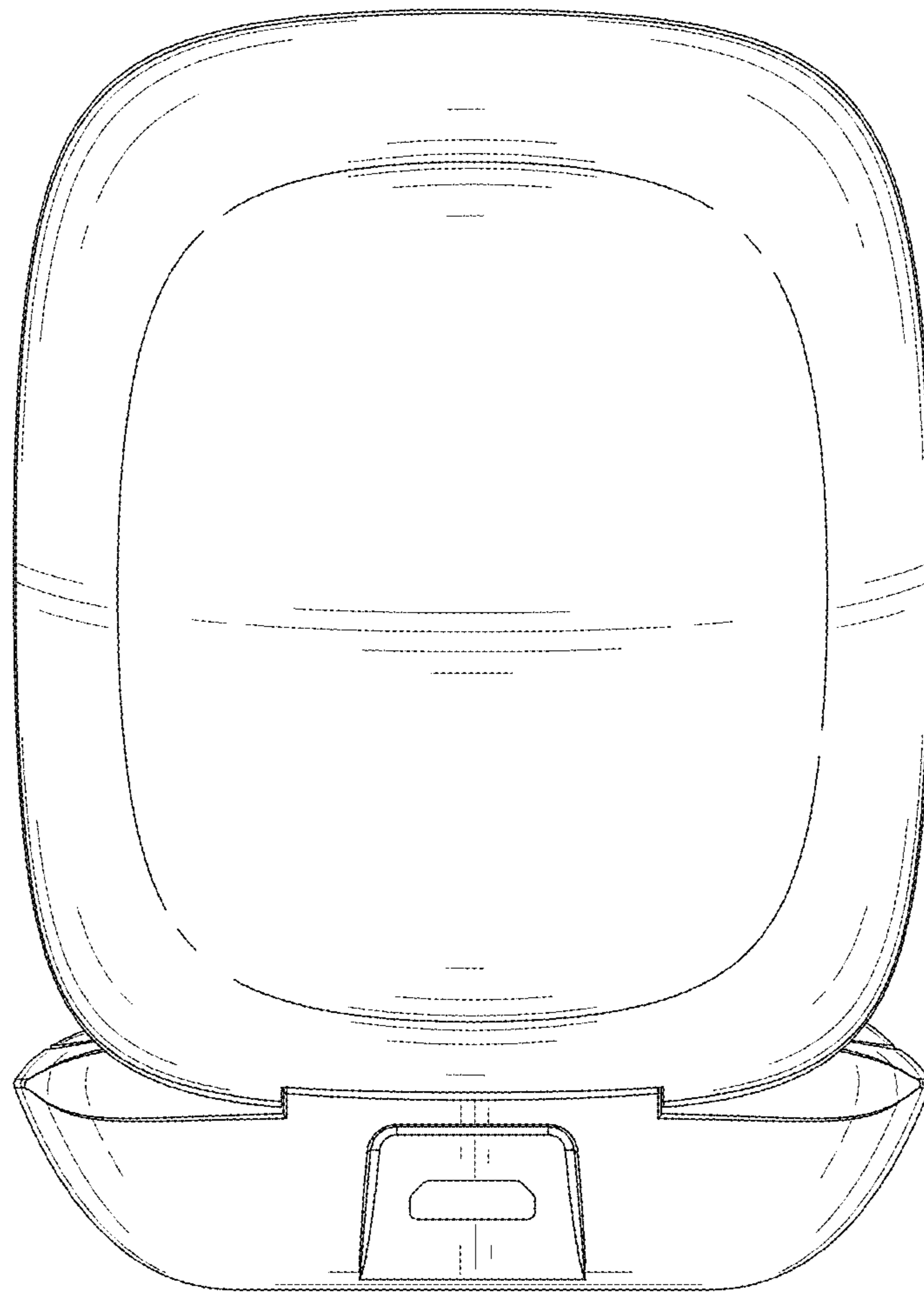

FIG. 24

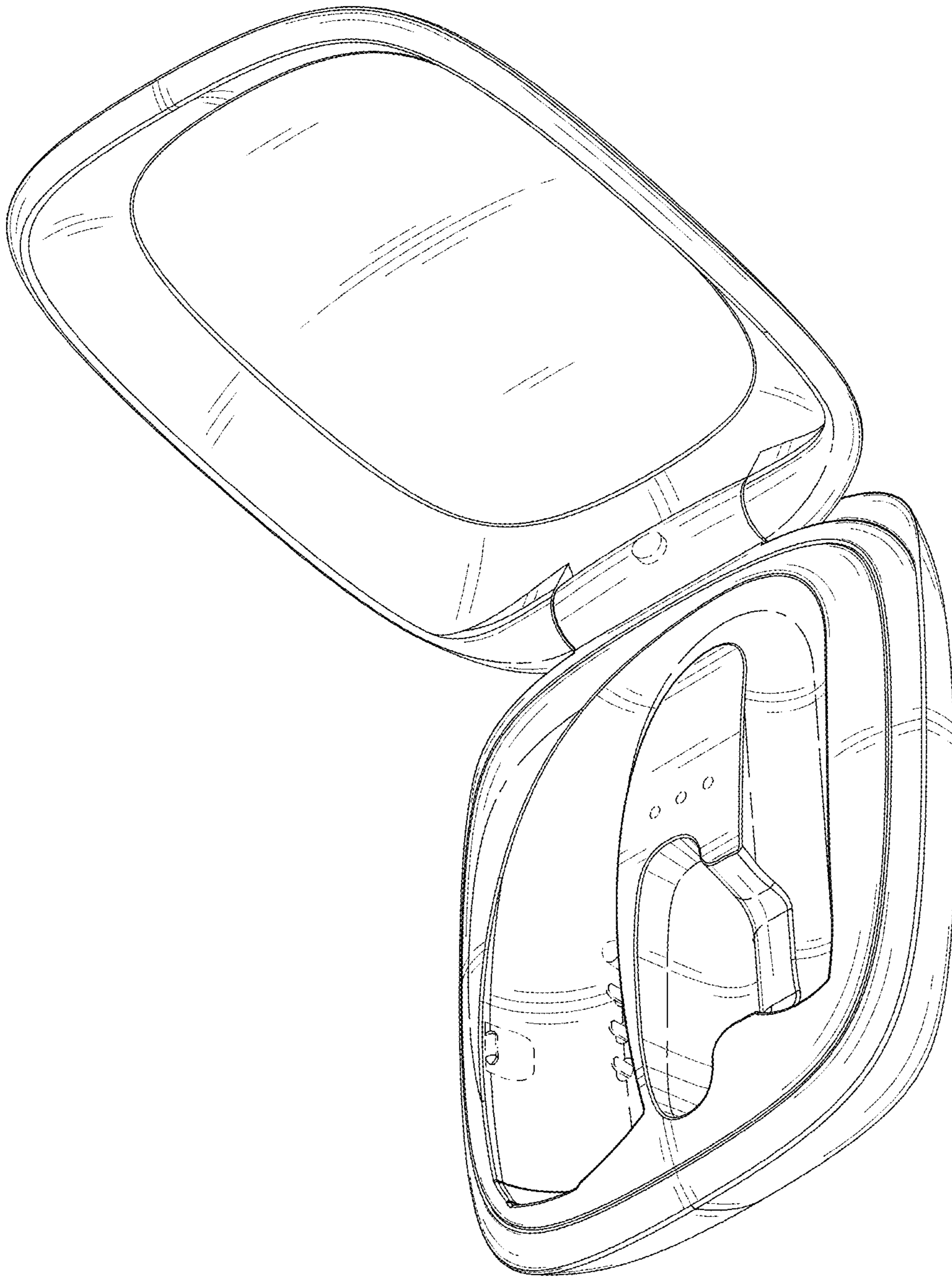

FIG. 25

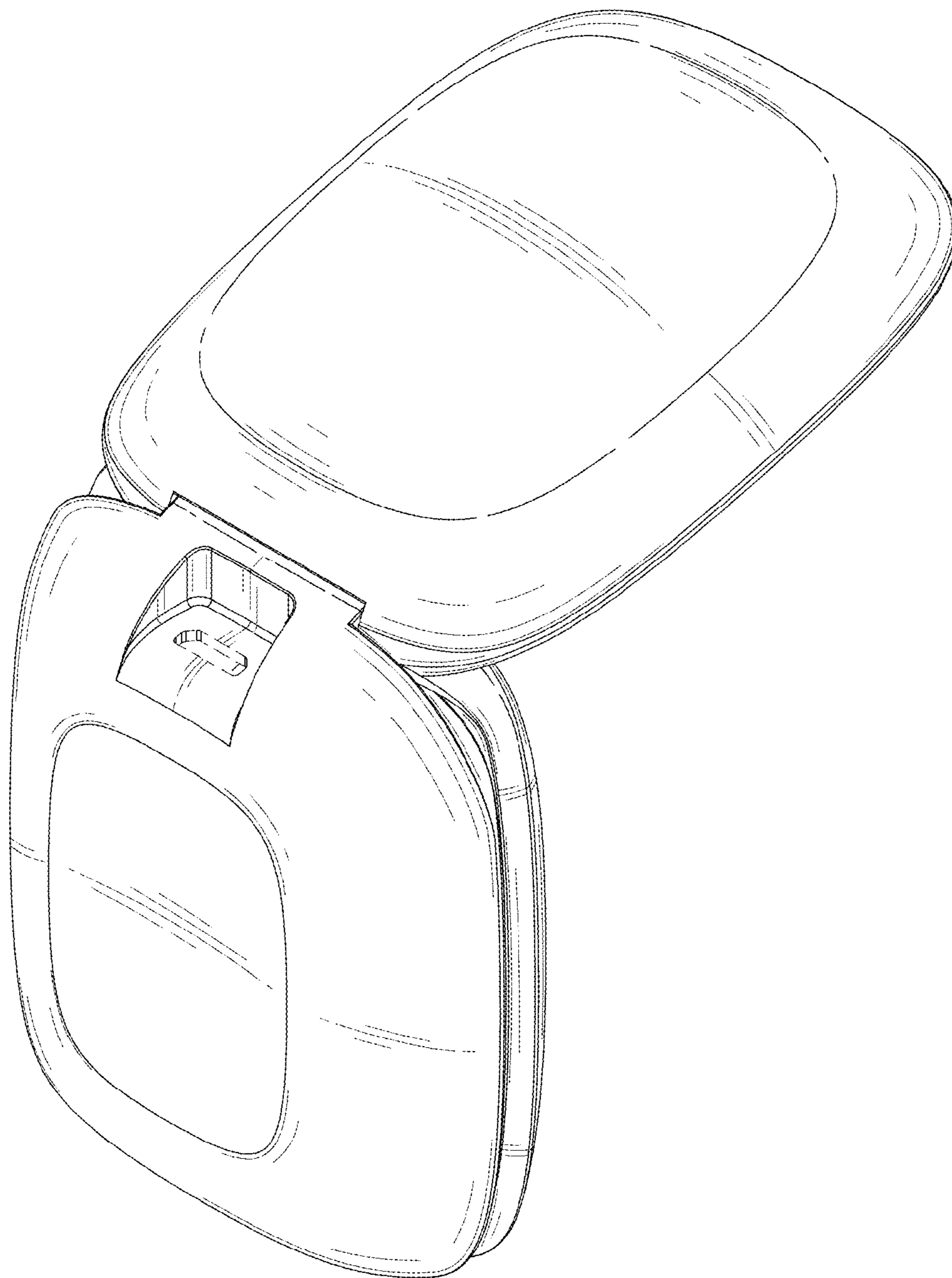

FIG. 26

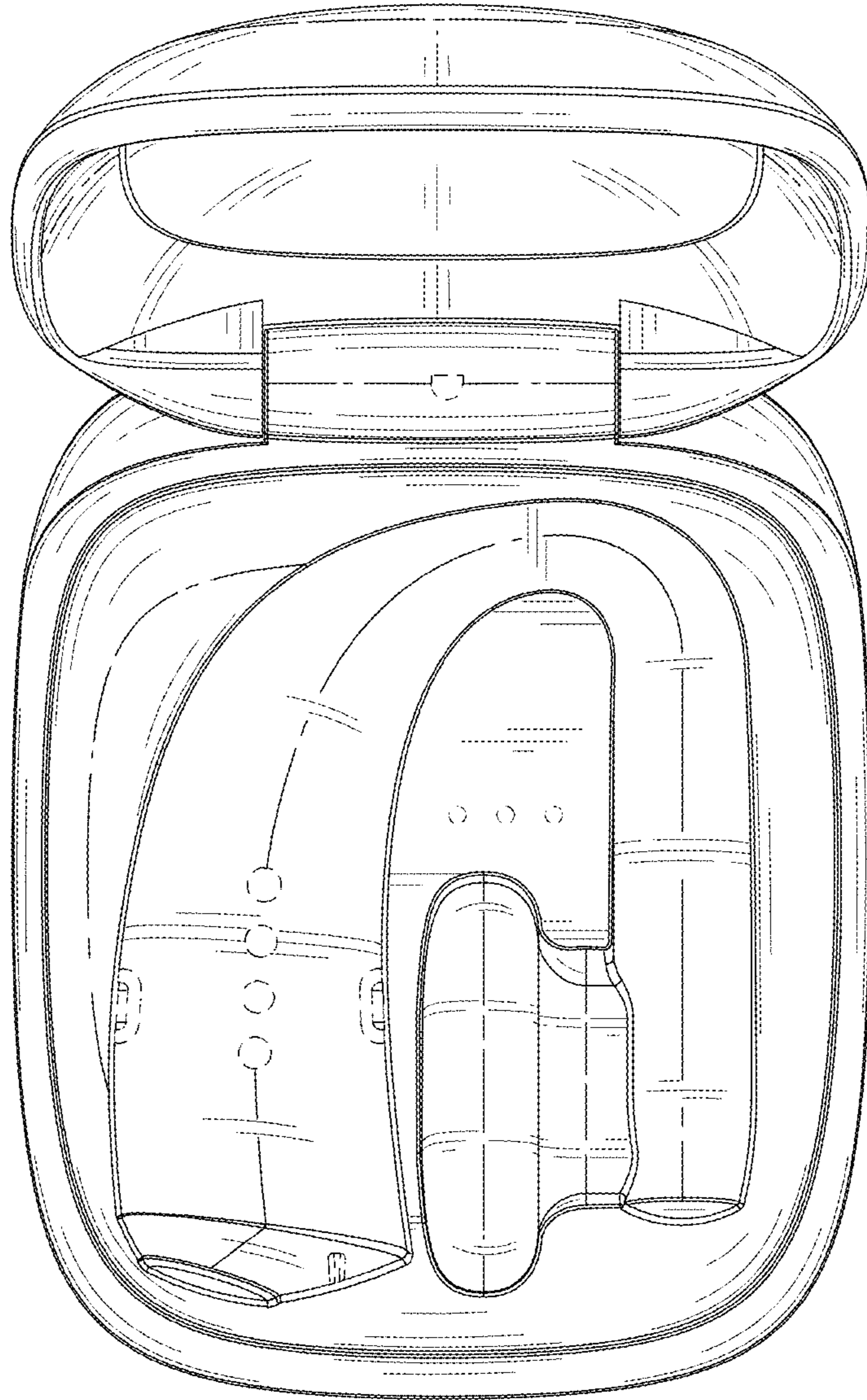

FIG. 27

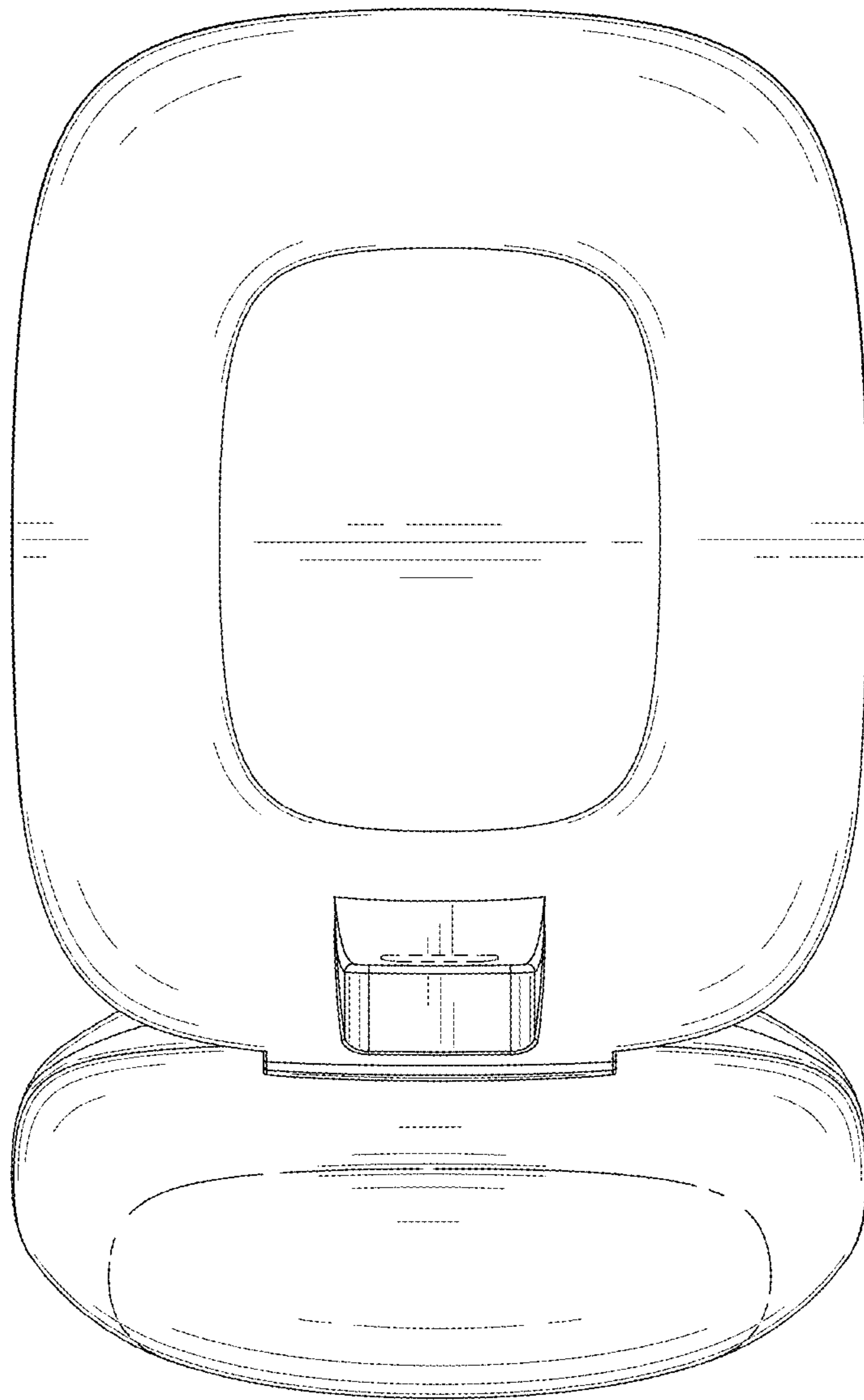

FIG. 28

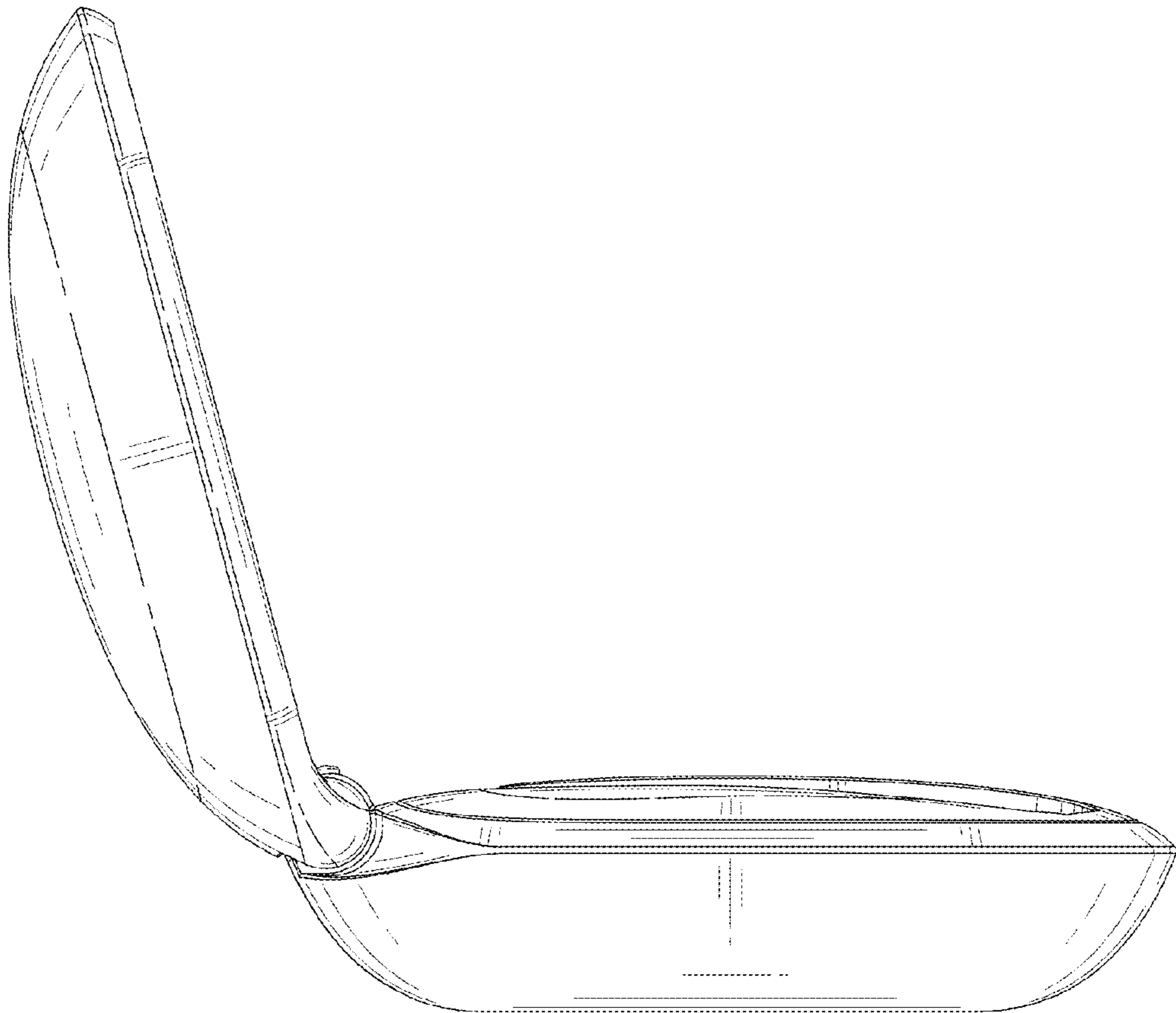

FIG. 29

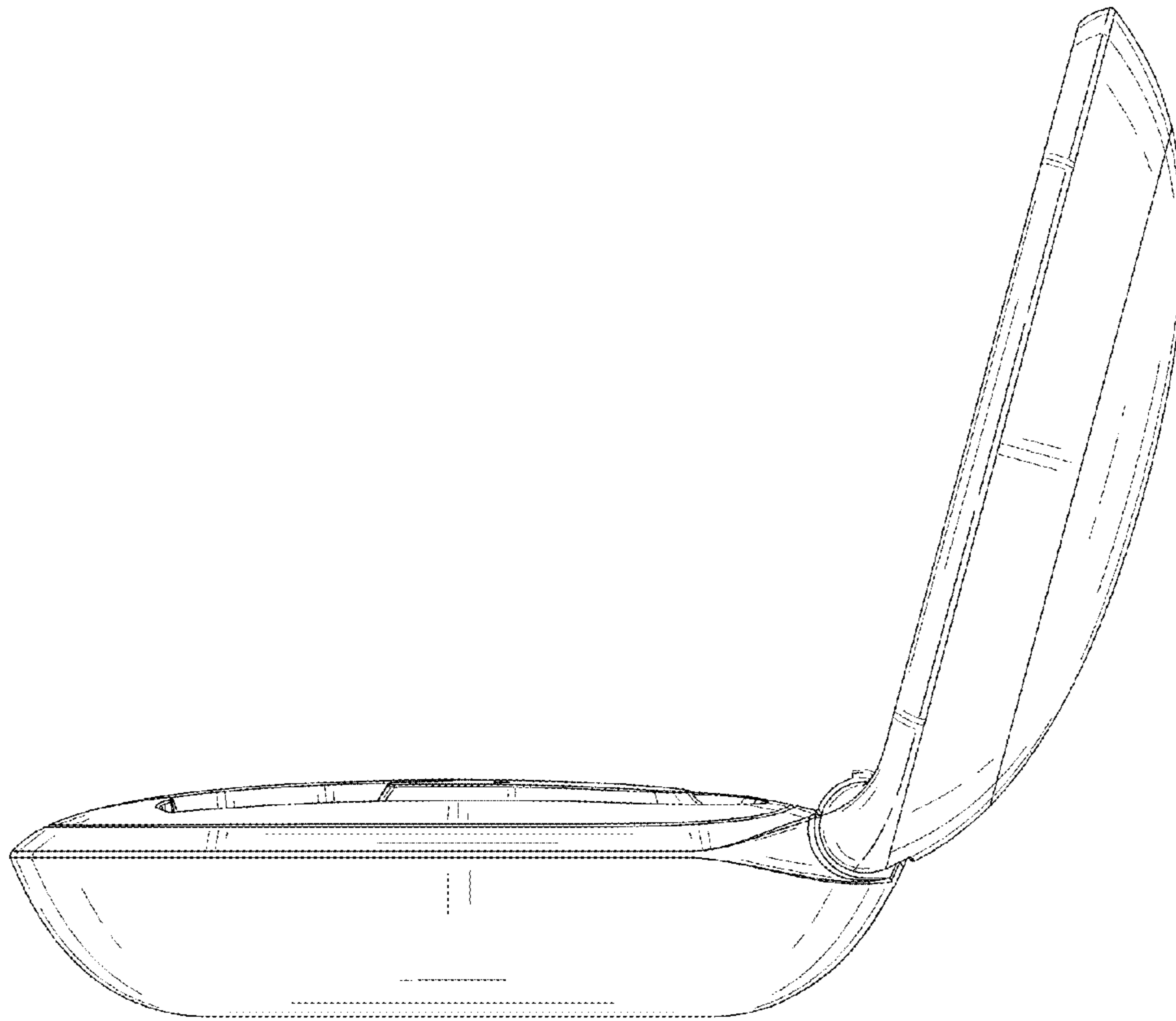

FIG. 30

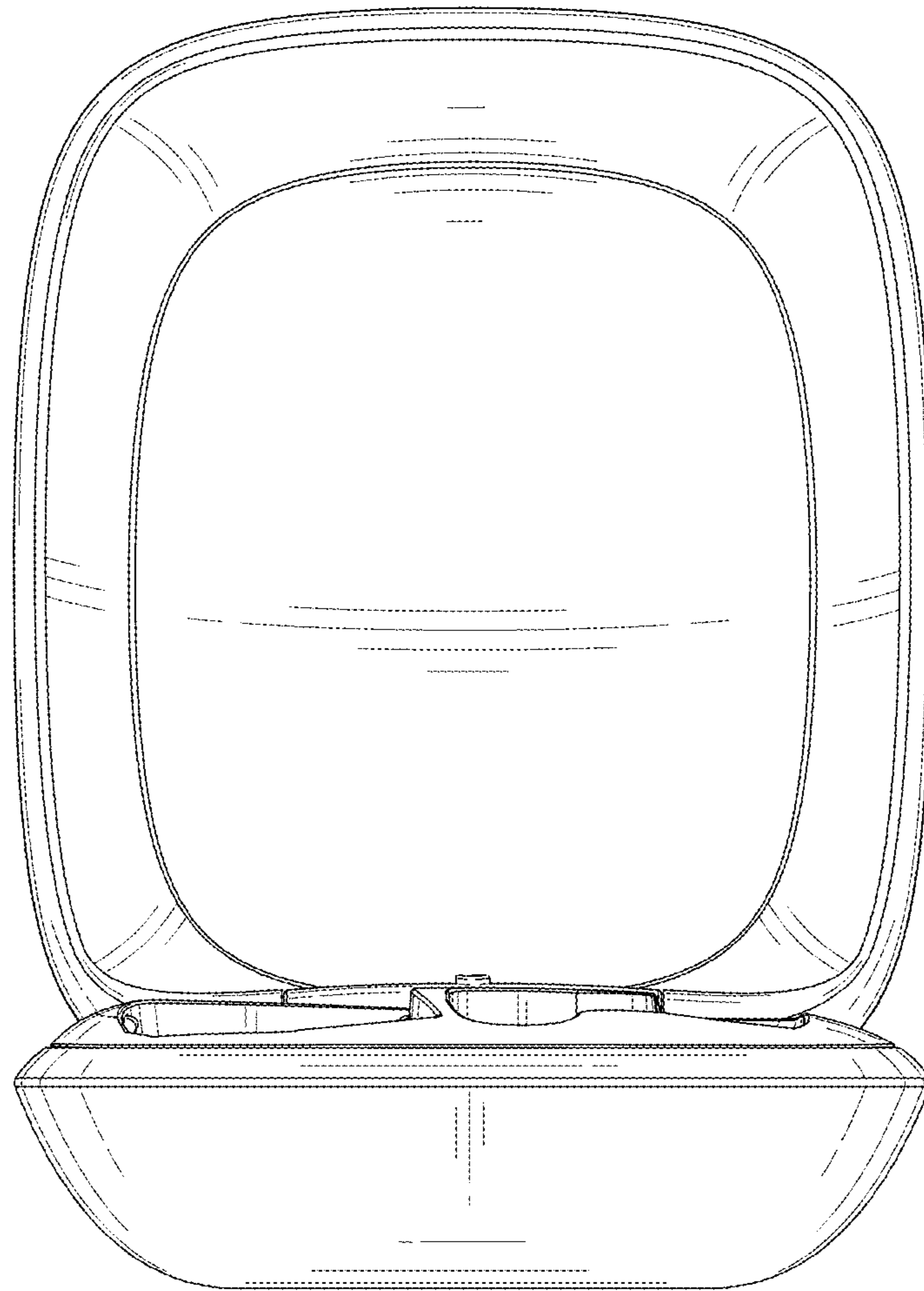

FIG. 31

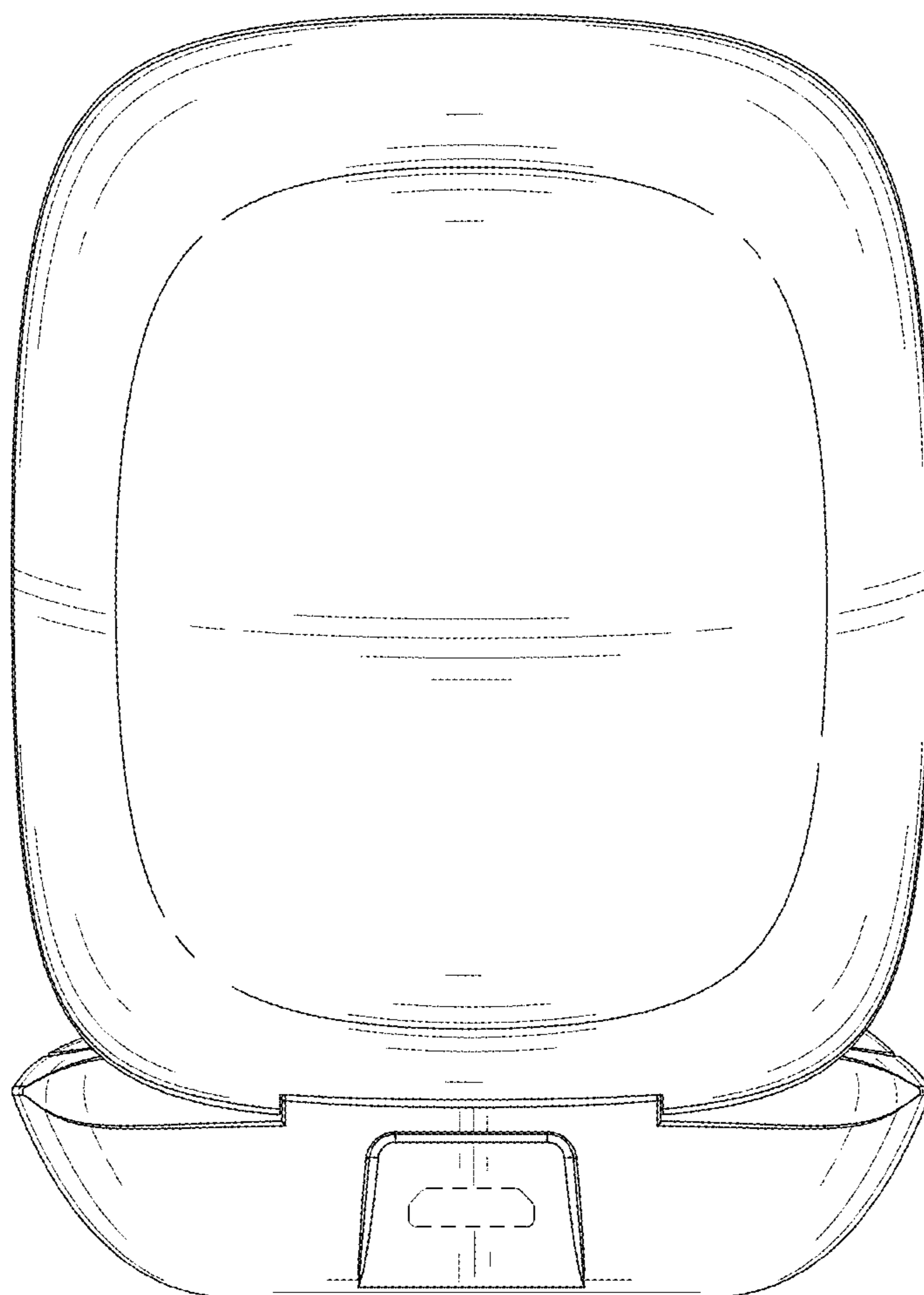

FIG. 32