



US00D731780S

(12) **United States Design Patent**
Mingo

(10) **Patent No.:** **US D731,780 S**
(45) **Date of Patent:** **** Jun. 16, 2015**

- (54) **UMBRELLA CADDY**
- (71) Applicant: **Michael Mingo**, Buffalo, NY (US)
- (72) Inventor: **Michael Mingo**, Buffalo, NY (US)
- (**) Term: **14 Years**
- (21) Appl. No.: **29/439,333**
- (22) Filed: **Dec. 10, 2012**
- (51) **LOC (10) Cl.** **03-01**
- (52) **U.S. Cl.**
USPC **D3/11**
- (58) **Field of Classification Search**
USPC D3/5, 6, 10, 11, 12; 135/15.1, 19.5,
135/25.41, 33.41, 34.2
See application file for complete search history.

- D478,726 S * 8/2003 Masso et al. D3/300
- D512,559 S * 12/2005 Silverman D3/11
- D525,786 S * 8/2006 Orlando D3/254
- D624,746 S 10/2010 Leung
- D681,323 S * 5/2013 Chin D3/11
- D688,042 S * 8/2013 King D3/276
- D692,226 S * 10/2013 Chin D3/11
- D692,651 S * 11/2013 Chin D3/11
- D704,439 S * 5/2014 Mangano D3/255

* cited by examiner

Primary Examiner — John Windmuller

(74) *Attorney, Agent, or Firm* — Vincent G. LoTempio;
Kloss, Stenger & LoTempio; David T. Stephenson

(57) **CLAIM**

The ornamental design for an umbrella caddy, as shown and described.

DESCRIPTION

FIG. 1 is a front perspective view of an umbrella caddy showing my new design;
 FIG. 2 is a rear elevation view thereof;
 FIG. 3 is a top plan view thereof;
 FIG. 4 is a bottom plan view thereof;
 FIG. 5 is a left side elevation view thereof;
 FIG. 6 is a right side elevation view thereof;
 FIG. 7 is a rear perspective view thereof; and,
 FIG. 8 is a rear perspective view thereof with the cap removed.
 The broken-line strap is a portion of the umbrella caddy which forms no part of the claimed design. The broken-line umbrella in FIG. 5 is environment only and forms no part of the claimed design. The broken-line male and female threads in FIG. 8 are environment only and form no part of the claimed design.

1 Claim, 3 Drawing Sheets

(56) **References Cited**

U.S. PATENT DOCUMENTS

- 693,432 A * 2/1902 Owen 206/315.5
- 1,903,798 A * 4/1933 Turner 224/613
- D140,671 S * 3/1945 Pascal D6/553
- 3,128,812 A * 4/1964 Scheurer 206/315.4
- D271,162 S * 11/1983 Evans D3/254
- 4,558,807 A * 12/1985 Jackson 224/251
- D283,758 S * 5/1986 Stewart et al. D7/703
- 4,832,362 A 5/1989 Chen
- D302,775 S * 8/1989 Sinoff et al. D7/608
- D321,088 S * 10/1991 Waters, Jr. D3/11
- D341,241 S 11/1993 Buckley
- D343,954 S * 2/1994 Simmons D22/107
- 5,620,119 A * 4/1997 Keller 224/190
- D380,085 S * 6/1997 Ramsey D3/215
- D391,755 S * 3/1998 Grimm et al. D3/11
- D393,742 S * 4/1998 El-Edwy D3/11
- D450,919 S * 11/2001 Lee D3/11
- D466,685 S * 12/2002 Gref D3/11
- D476,151 S * 6/2003 Peterson D3/254

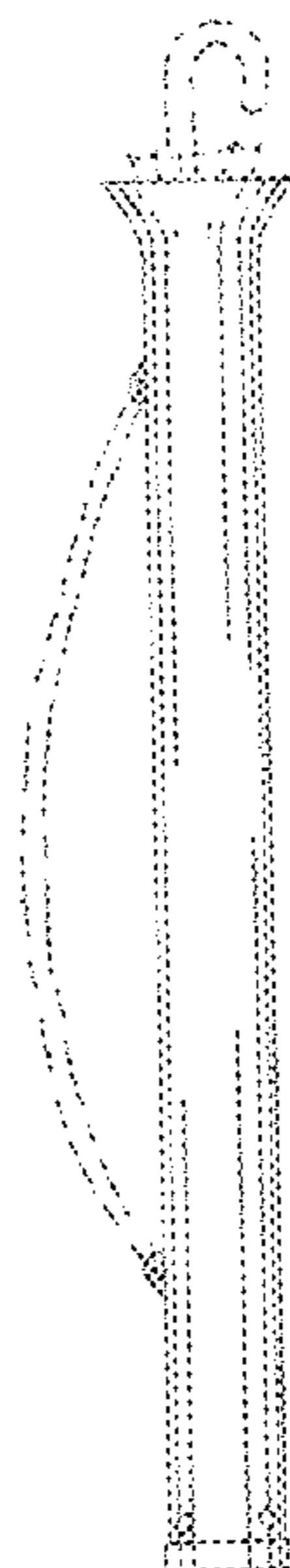

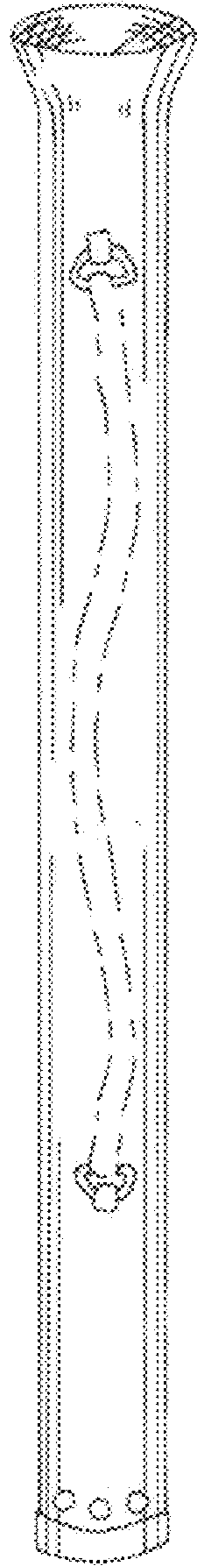

FIG.1

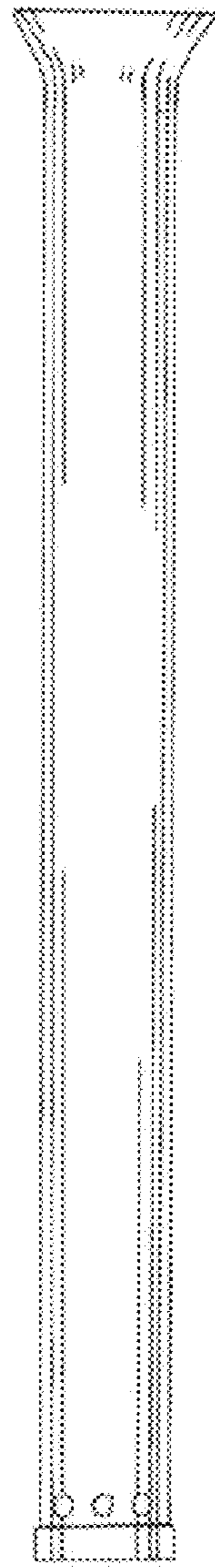

FIG.2

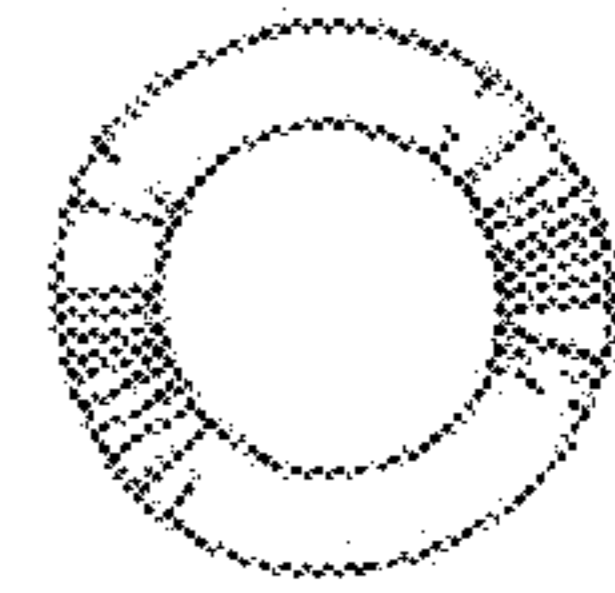

FIG.3

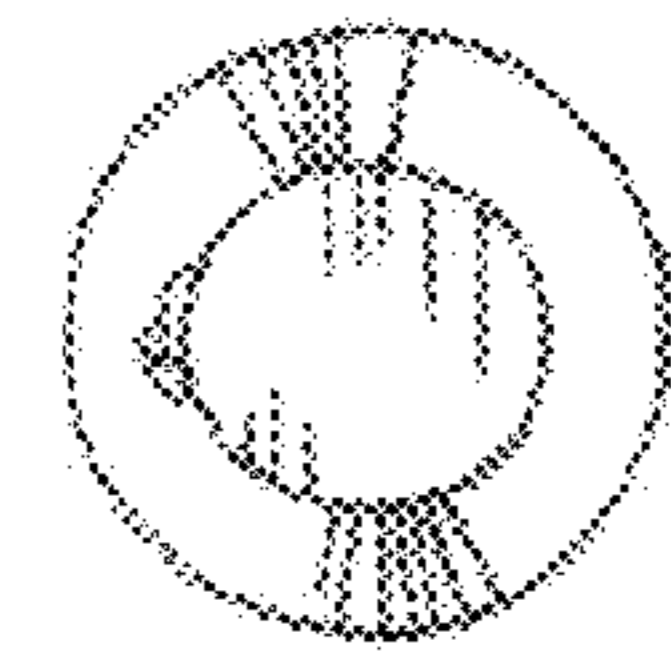

FIG.4

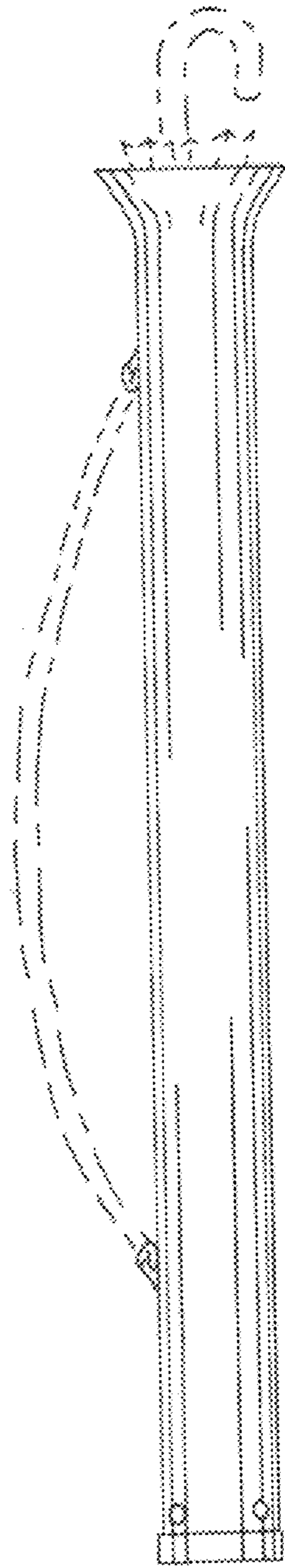

FIG. 5

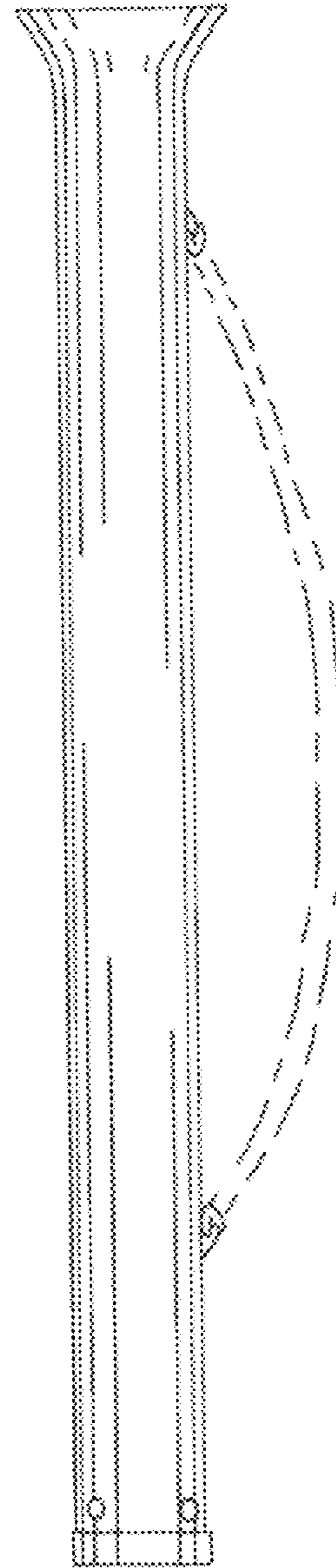

FIG. 6

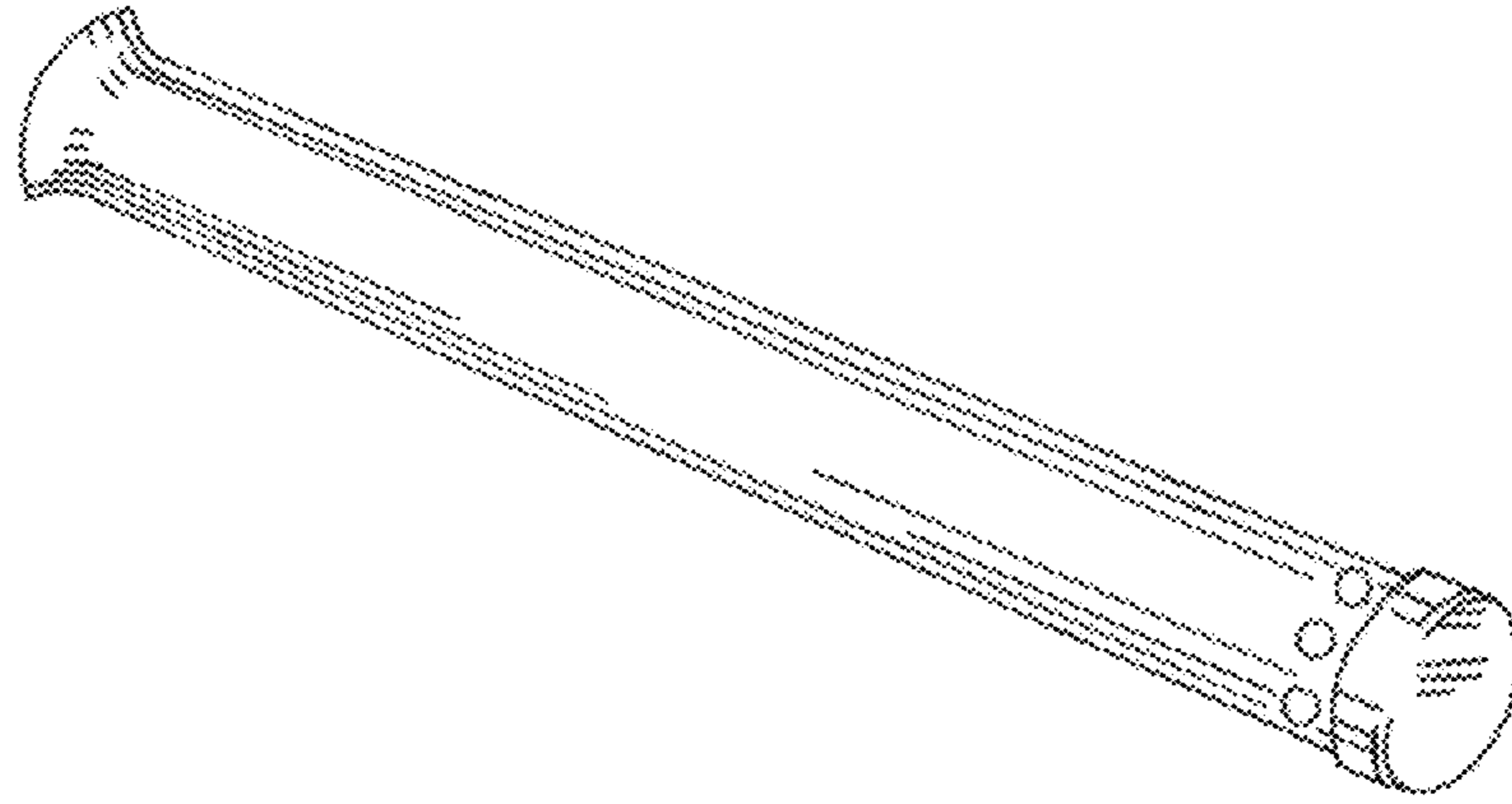

FIG. 7

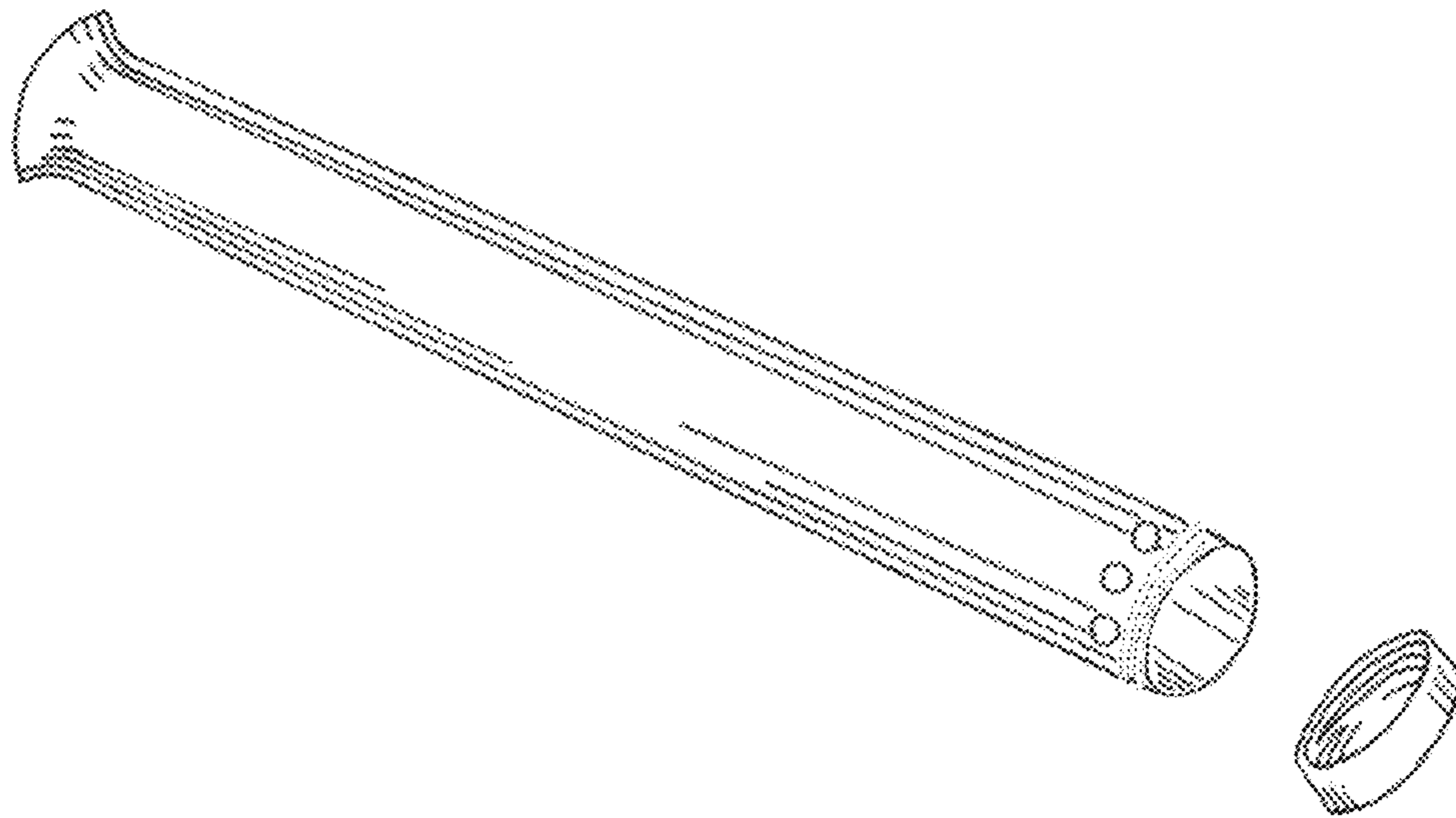

FIG. 8