



US00D731681S

(12) **United States Design Patent**
Pu et al.

(10) **Patent No.:** **US D731,681 S**
(45) **Date of Patent:** **** Jun. 9, 2015**

(54) **LED UNIT**

(56) **References Cited**

(71) Applicant: **Formosa Epitaxy Incorporation**,
Taoyuan County (TW)
(72) Inventors: **Chi-Chih Pu**, Taoyuan County (TW);
Chen-Hong Lee, Taoyuan County (TW);
Tzu-Hsiang Wang, Taoyuan County
(TW); **Wei-Kang Cheng**, Taoyuan
County (TW); **Shyi-Ming Pan**, Taoyuan
County (TW)

U.S. PATENT DOCUMENTS

7,585,090	B2 *	9/2009	Wu	362/249.02
8,083,375	B2 *	12/2011	Kong	362/249.02
D667,972	S *	9/2012	Sakamoto et al.	D26/2
D668,365	S *	10/2012	Sakamoto et al.	D26/2
8,282,242	B1 *	10/2012	Sikora	362/249.02
D671,240	S *	11/2012	Sakamoto et al.	D26/2

* cited by examiner

(73) Assignee: **Formosa Epitaxy Incorporation**,
Taoyuan County (TW)

Primary Examiner — Marcus Jackson

(74) *Attorney, Agent, or Firm* — Jianq Chyun IP Office

(**) Term: **14 Years**

(57) **CLAIM**

The ornamental design for a LED unit, as shown and described.

(21) Appl. No.: **29/461,970**

(22) Filed: **Jul. 30, 2013**

DESCRIPTION

(30) **Foreign Application Priority Data**

Feb. 1, 2013 (TW) 102300913

(51) **LOC (10) Cl.** **26-04**

(52) **U.S. Cl.**
USPC **D26/1; D13/180**

(58) **Field of Classification Search**
USPC D26/1-4; D13/180; 257/79, 80, 81, 88,
257/89, 95, 98, 99; 313/313-318;
362/249.02, 555, 802
CPC ... H01L 25/167; H01L 25/0753; H01L 27/15;
H01L 33/486
See application file for complete search history.

FIG. 1 is a perspective view of a LED unit showing our new design;

FIG. 2 is a front view thereof;

FIG. 3 is a rear view thereof;

FIG. 4 is a left side view thereof;

FIG. 5 is a right side view thereof;

FIG. 6 is a top view thereof; and,

FIG. 7 is a bottom view thereof.

The broken line portions of the LED unit in all views represent unclaimed portions of the claimed design and form no part thereof.

1 Claim, 7 Drawing Sheets

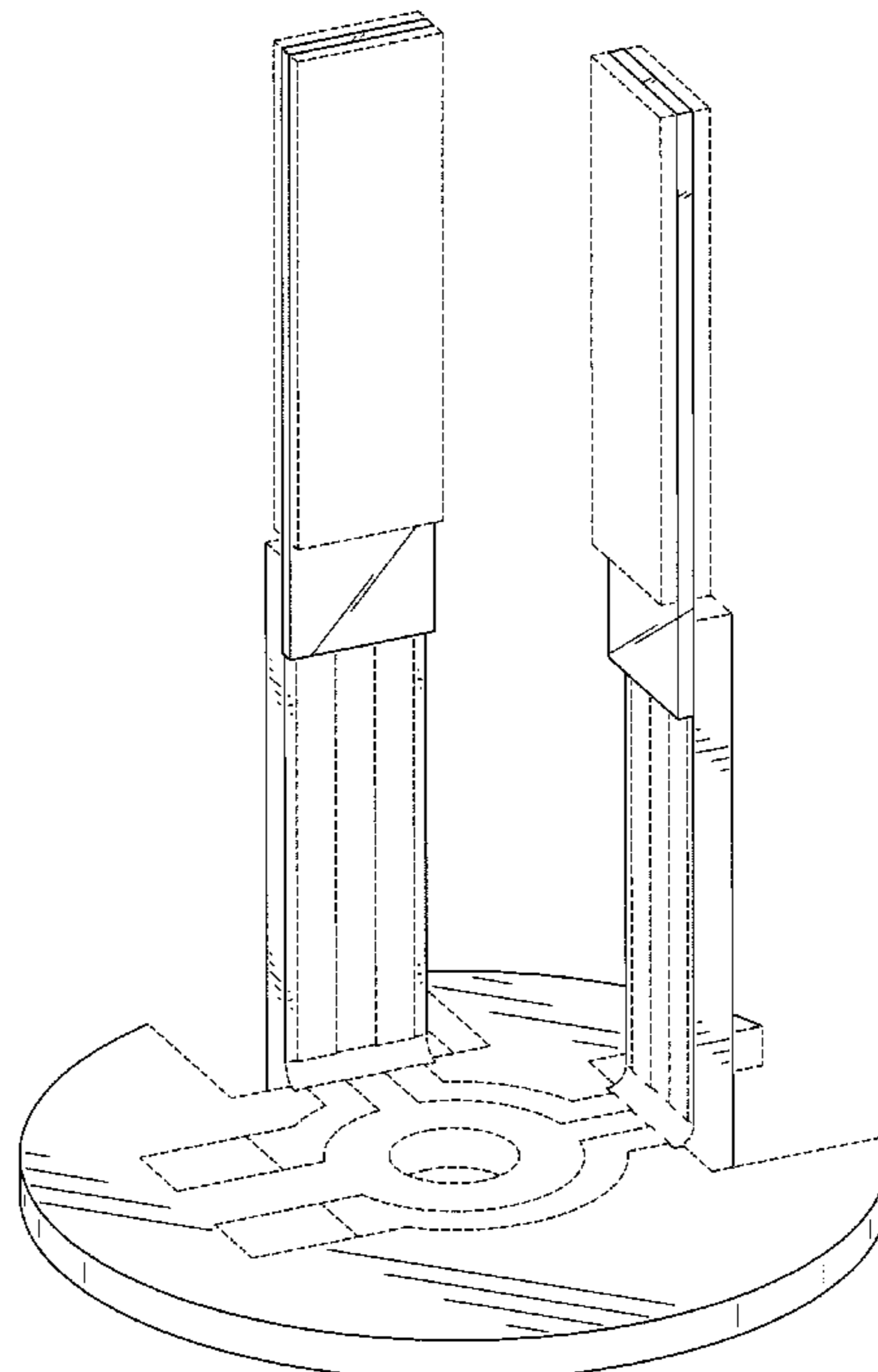

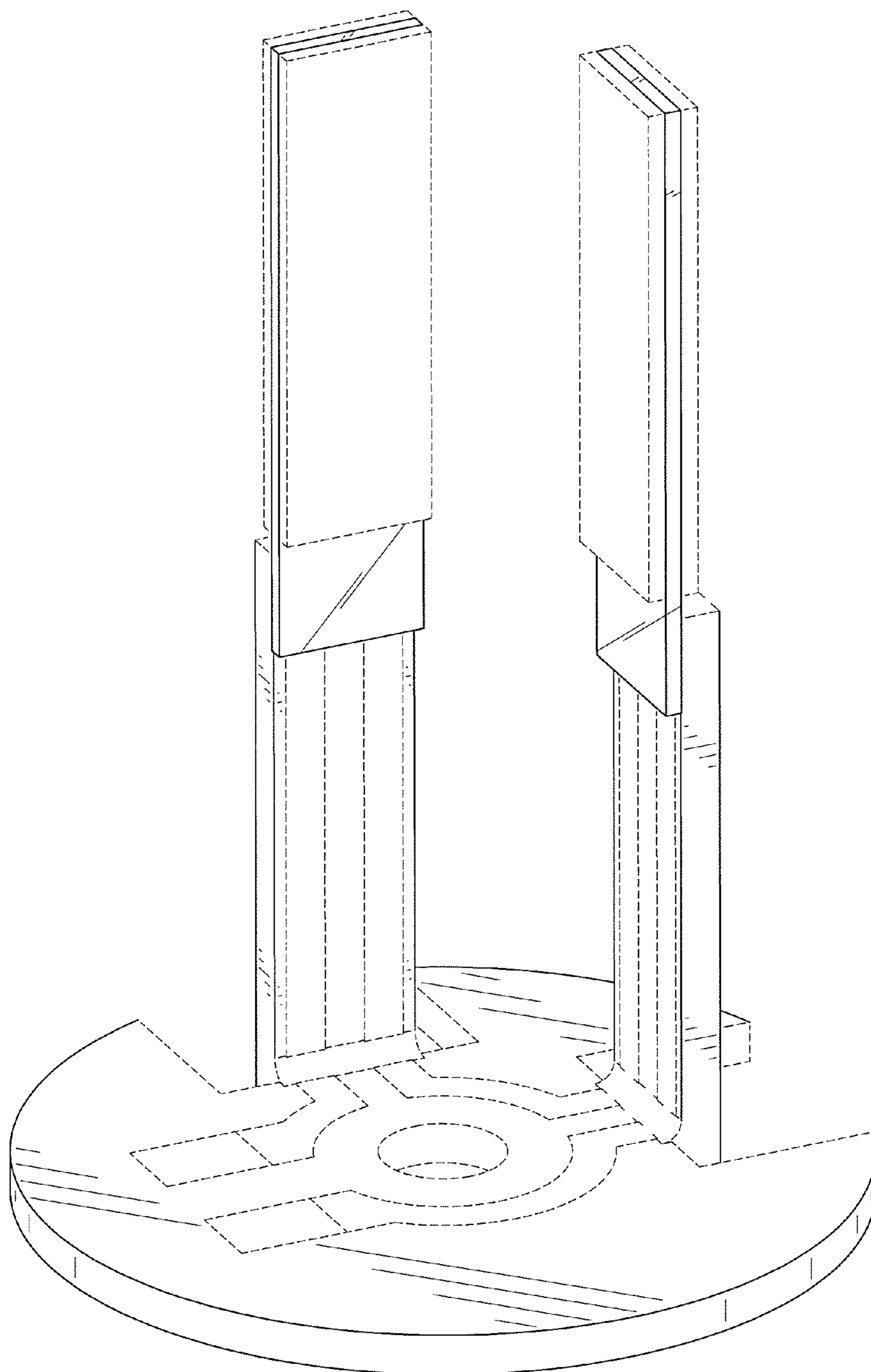

FIG. 1

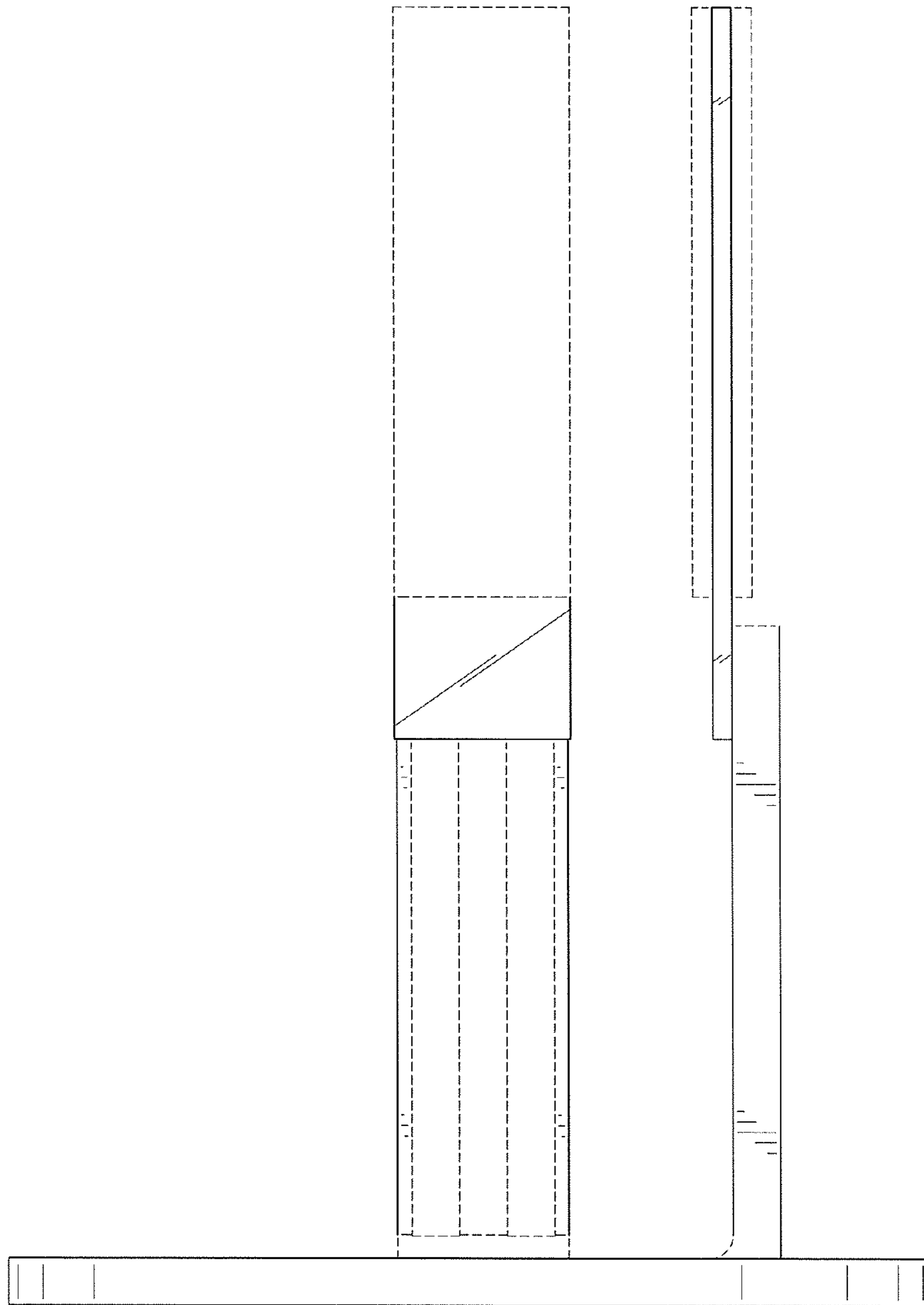

FIG. 2

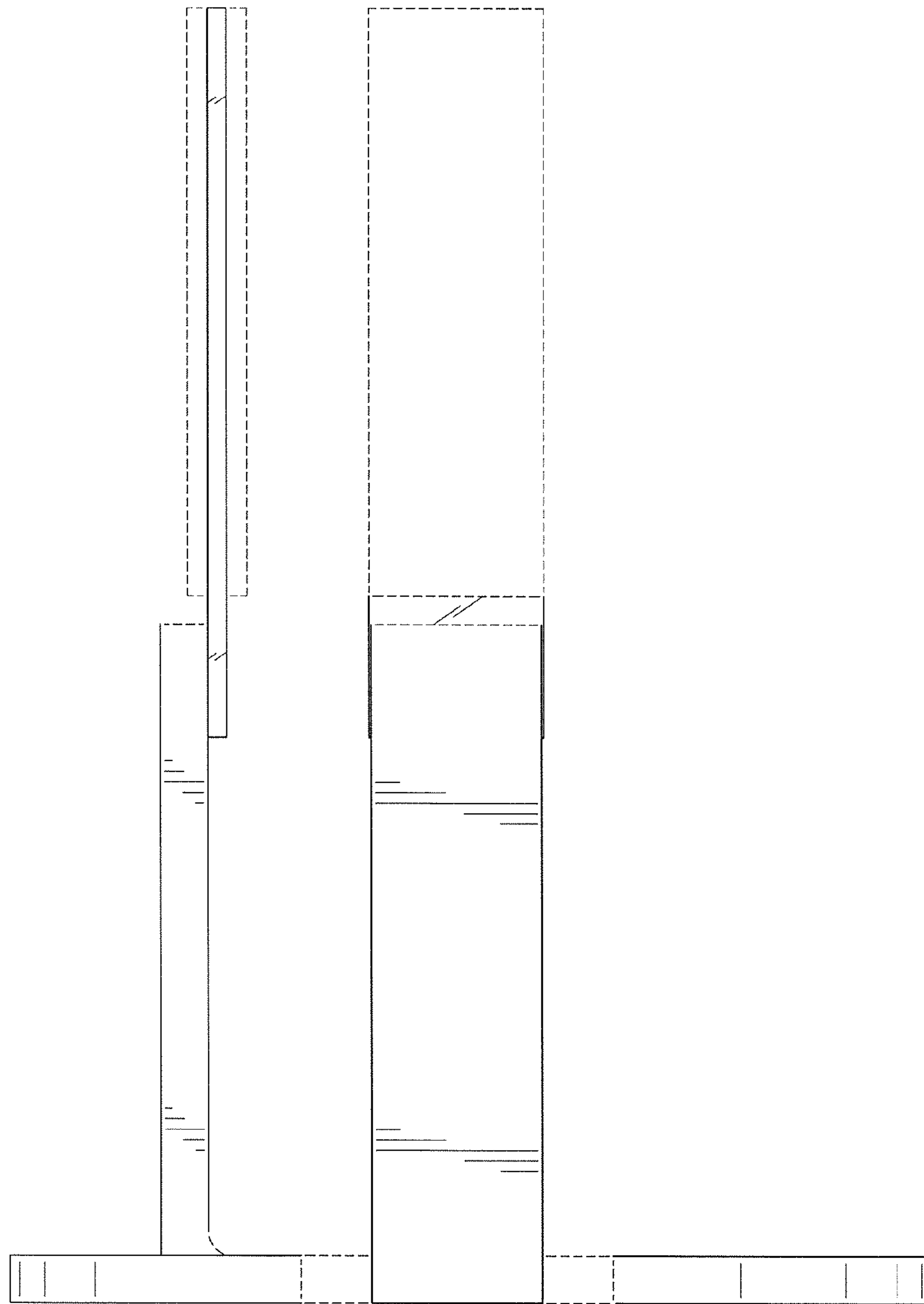

FIG. 3

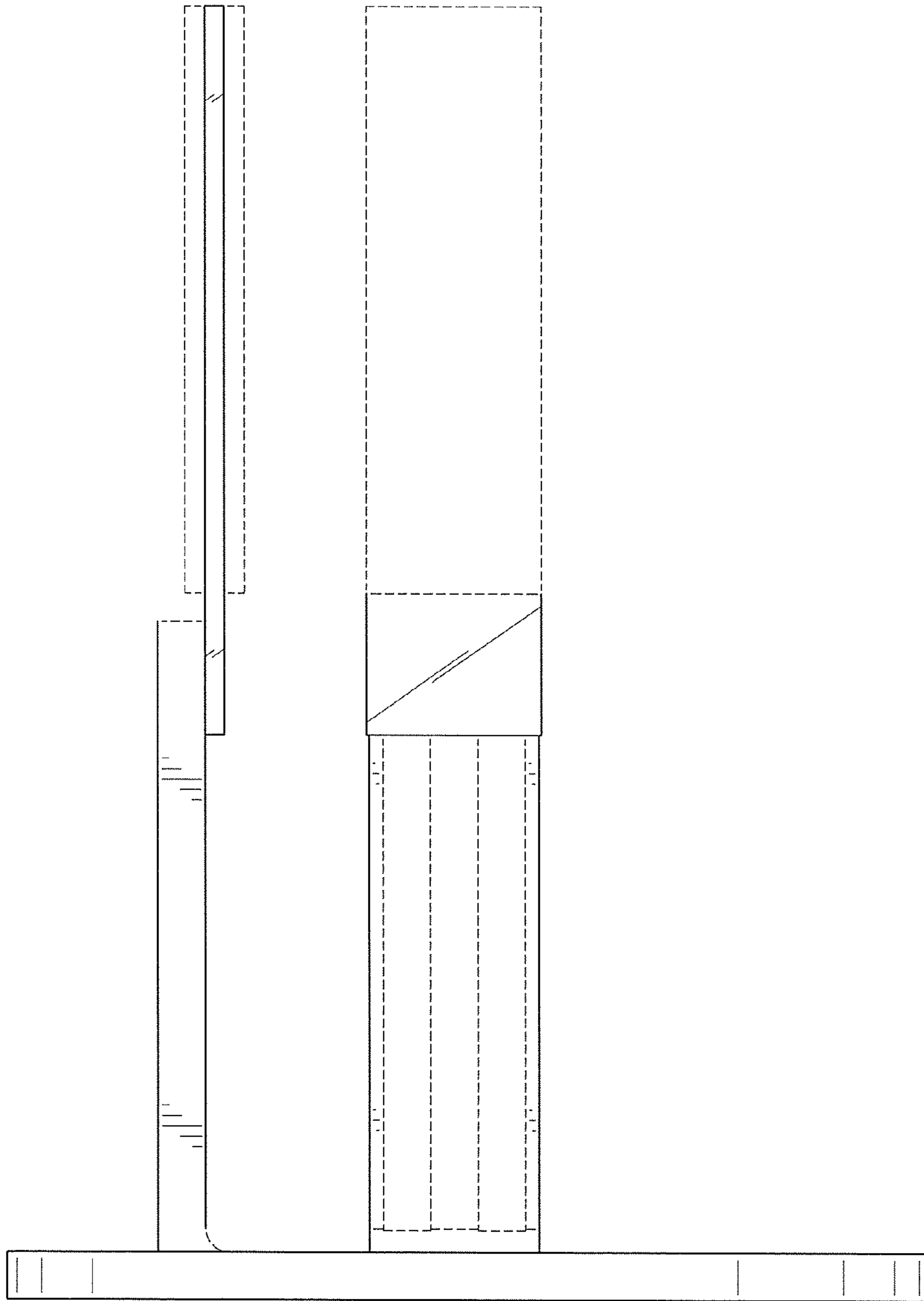

FIG. 4

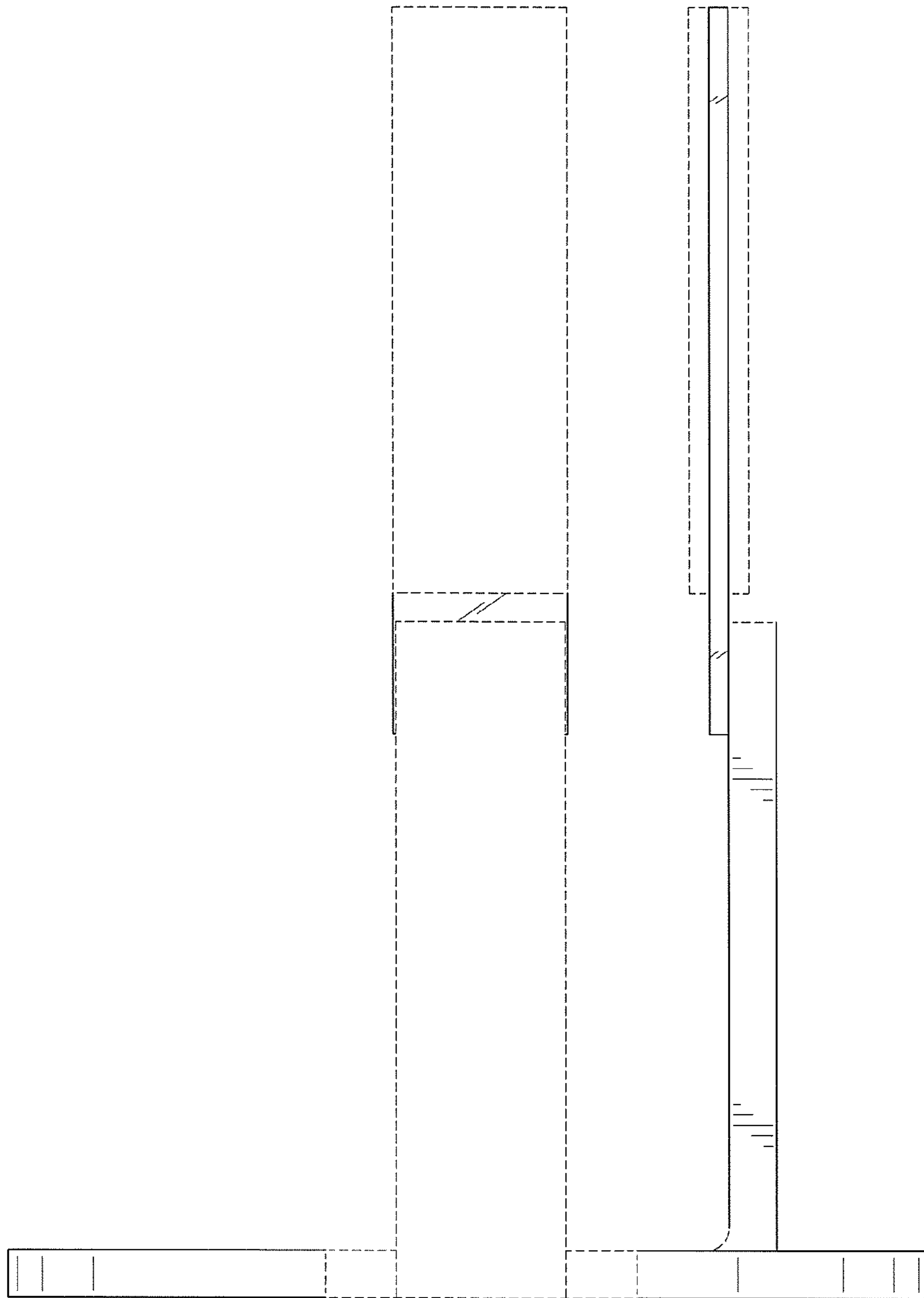

FIG. 5

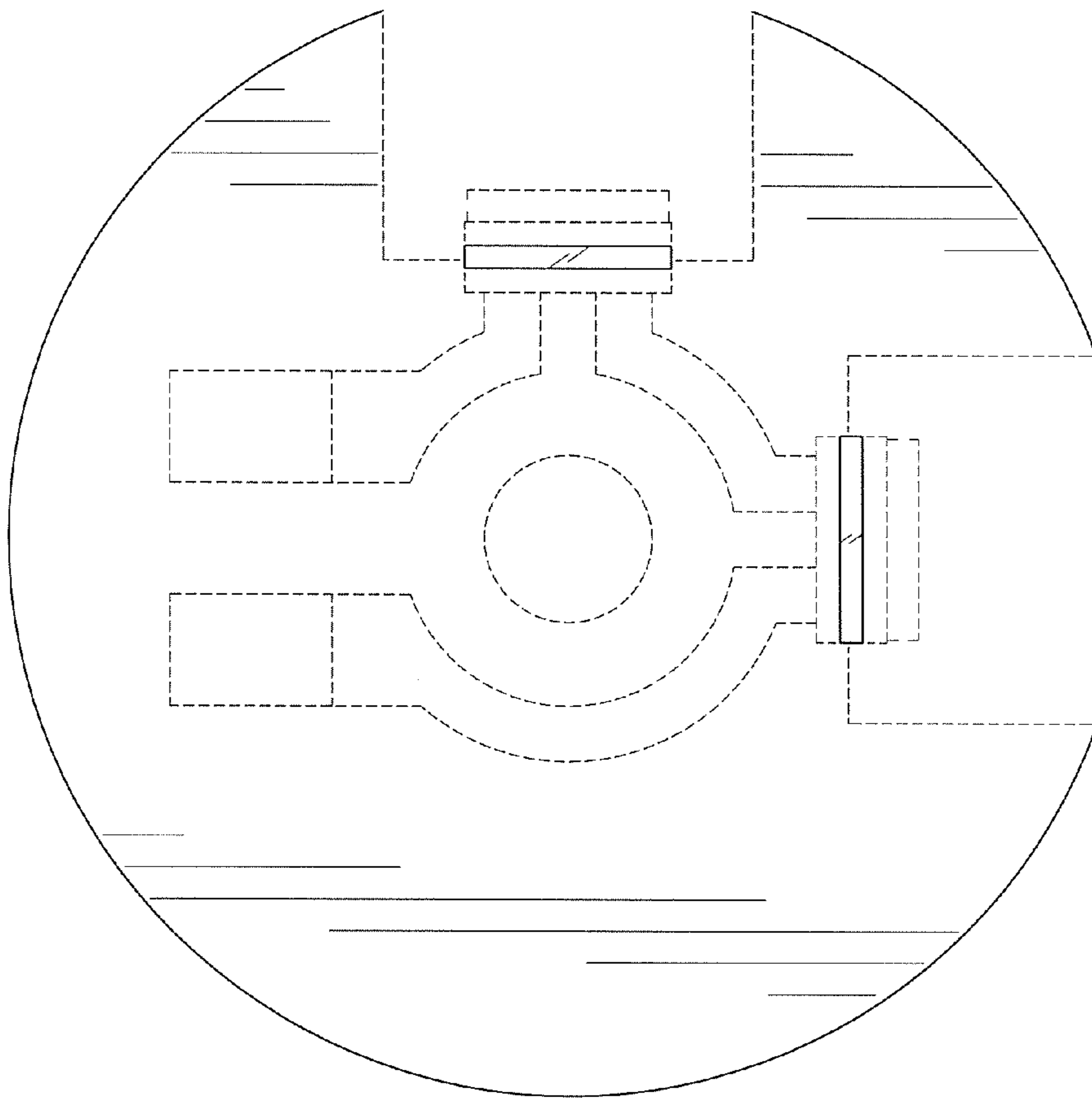

FIG. 6

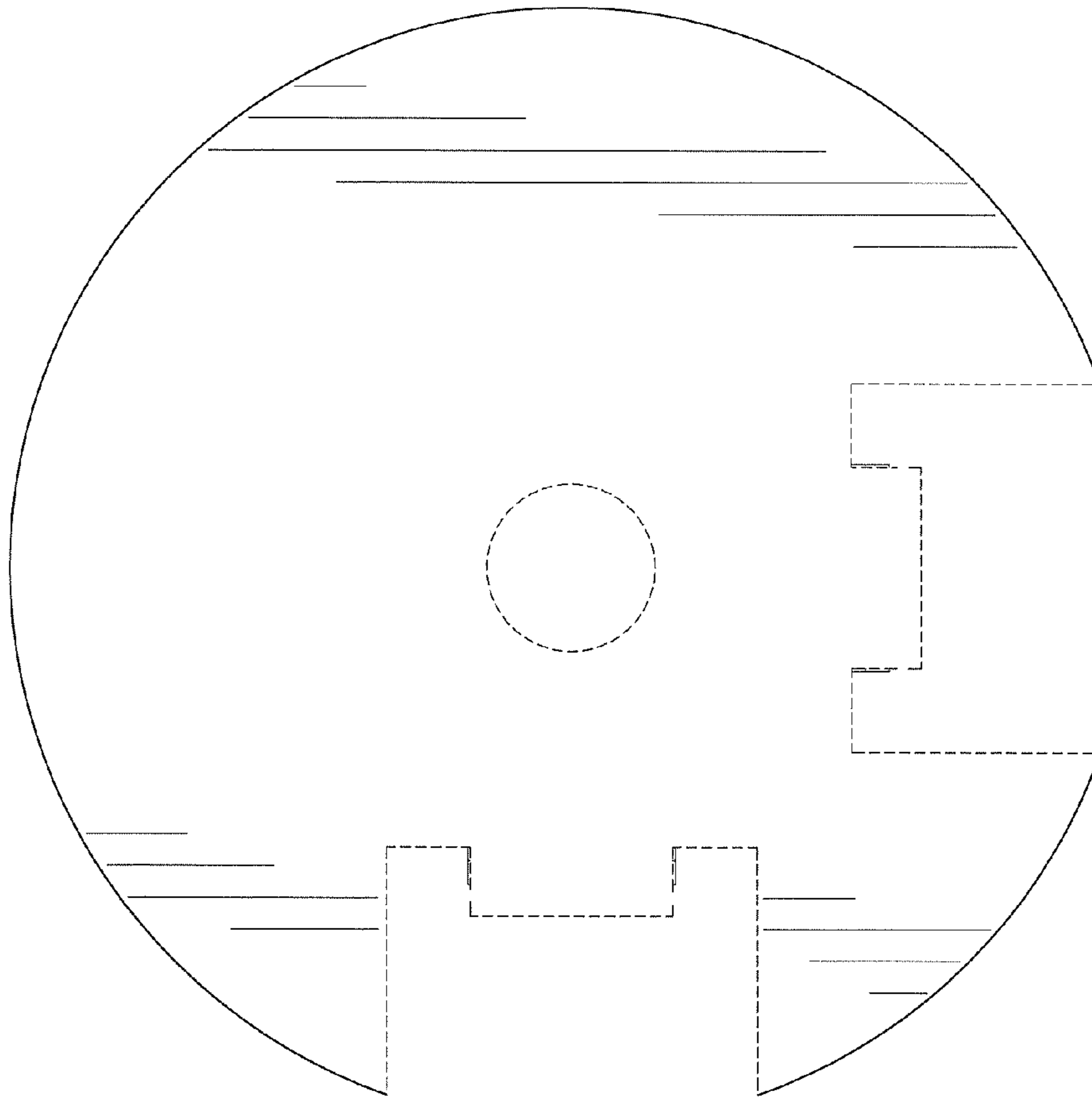

FIG. 7