



US00D731676S

(12) **United States Design Patent**
Karau

(10) **Patent No.:** **US D731,676 S**
(45) **Date of Patent:** **** Jun. 9, 2015**

(54) **RETAINING WALL BLOCK AND CAP
MODULE**

D433,157 S * 10/2000 Whitson D25/113
D499,773 S * 12/2004 May et al. D21/499
8,640,411 B1 * 2/2014 Wauhop 52/300

(71) Applicant: **PAVESTONE, LLC**, Atlanta, GA (US)

* cited by examiner

(72) Inventor: **William H. Karau**, Southlake, TX (US)

Primary Examiner — Anhdao Doan

(73) Assignee: **PAVESTONE, LLC**, Atlanta, GA (US)

(74) *Attorney, Agent, or Firm* — Jackson Walker L.L.P.;
Christopher J. Rourk

(**) Term: **14 Years**

(57) **CLAIM**

The ornamental design for a retaining wall block and cap module, as shown and described.

(21) Appl. No.: **29/490,228**

(22) Filed: **May 7, 2014**

DESCRIPTION

(51) **LOC (10) Cl.** **25-01**

(52) **U.S. Cl.**
USPC **D25/113**

(58) **Field of Classification Search**
USPC D25/113–118, 164, 102, 138, 149, 152,
D25/153, 199; D21/484–491, 499–504;
405/16, 284, 286; 52/503–505, 574,
52/575, 596–612, 592.6, 561, 566, 300;
404/27–42; D8/1

See application file for complete search history.

FIG. 1 shows a perspective view of a retaining wall block and cap module;

FIG. 2 shows a front view of the retaining wall block and cap module illustrated in FIG. 1;

FIG. 3 shows a back view of the retaining wall block and cap module illustrated in FIG. 1;

FIG. 4 shows a right side view of the retaining wall block and cap module illustrated in FIG. 1;

FIG. 5 shows a left side view of the retaining wall block and cap module illustrated in FIG. 1;

FIG. 6 shows a top view of the retaining wall block and cap module illustrated in FIG. 1; and,

FIG. 7 shows a bottom view of the retaining wall block and cap module illustrated in FIG. 1.

The broken lines in the drawing views are included for the purpose of illustrating portions of the retaining wall block and cap module that form no part of the claimed design.

(56) **References Cited**

U.S. PATENT DOCUMENTS

D299,069 S * 12/1988 Risi et al. D25/157
4,926,595 A * 5/1990 Dean, Jr. 52/300
D346,224 S * 4/1994 McClinton et al. D25/118
5,421,135 A * 6/1995 Stevens et al. 52/604
D378,702 S * 4/1997 Blomquist et al. D25/113

1 Claim, 2 Drawing Sheets

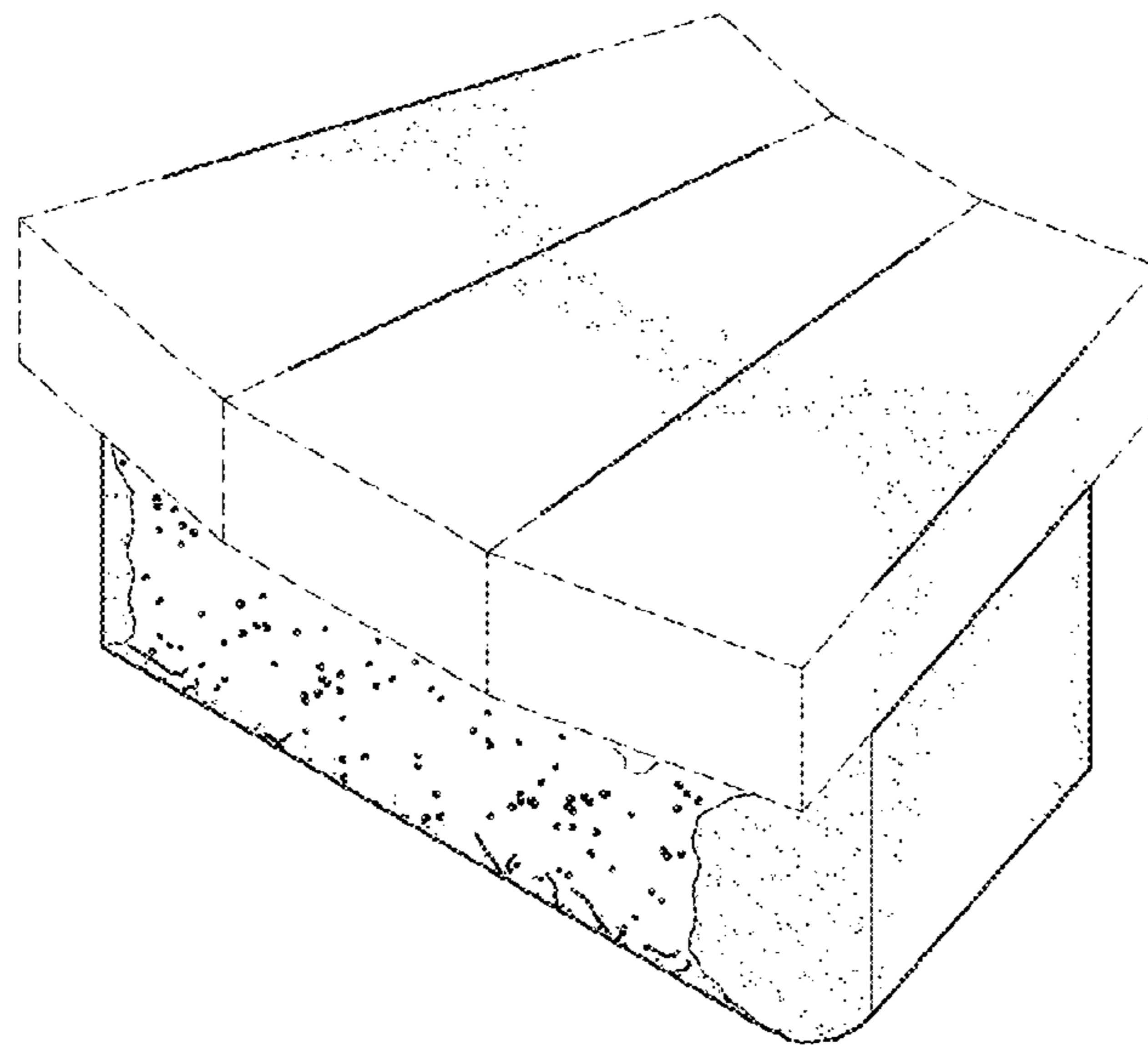

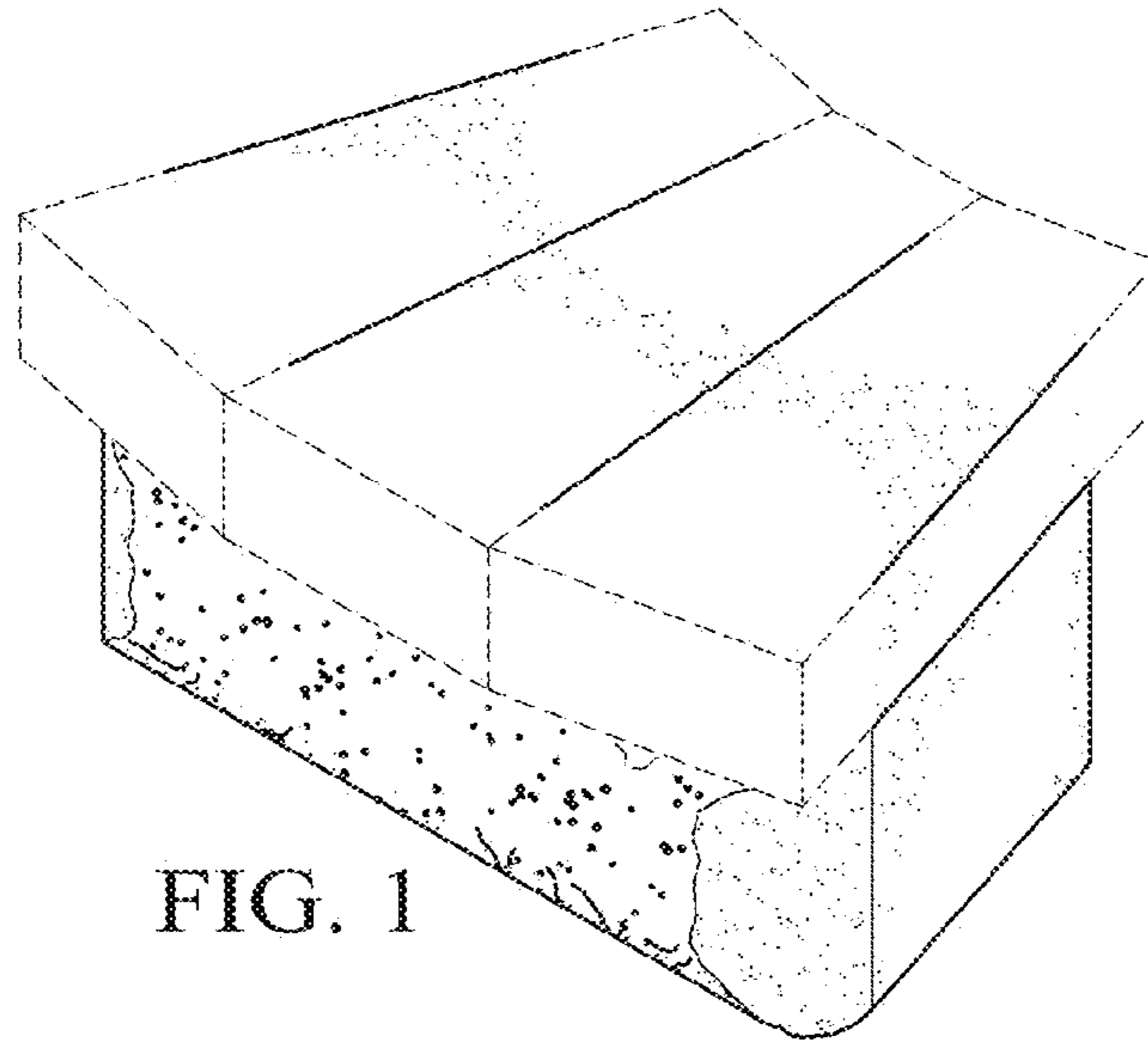

FIG. 1

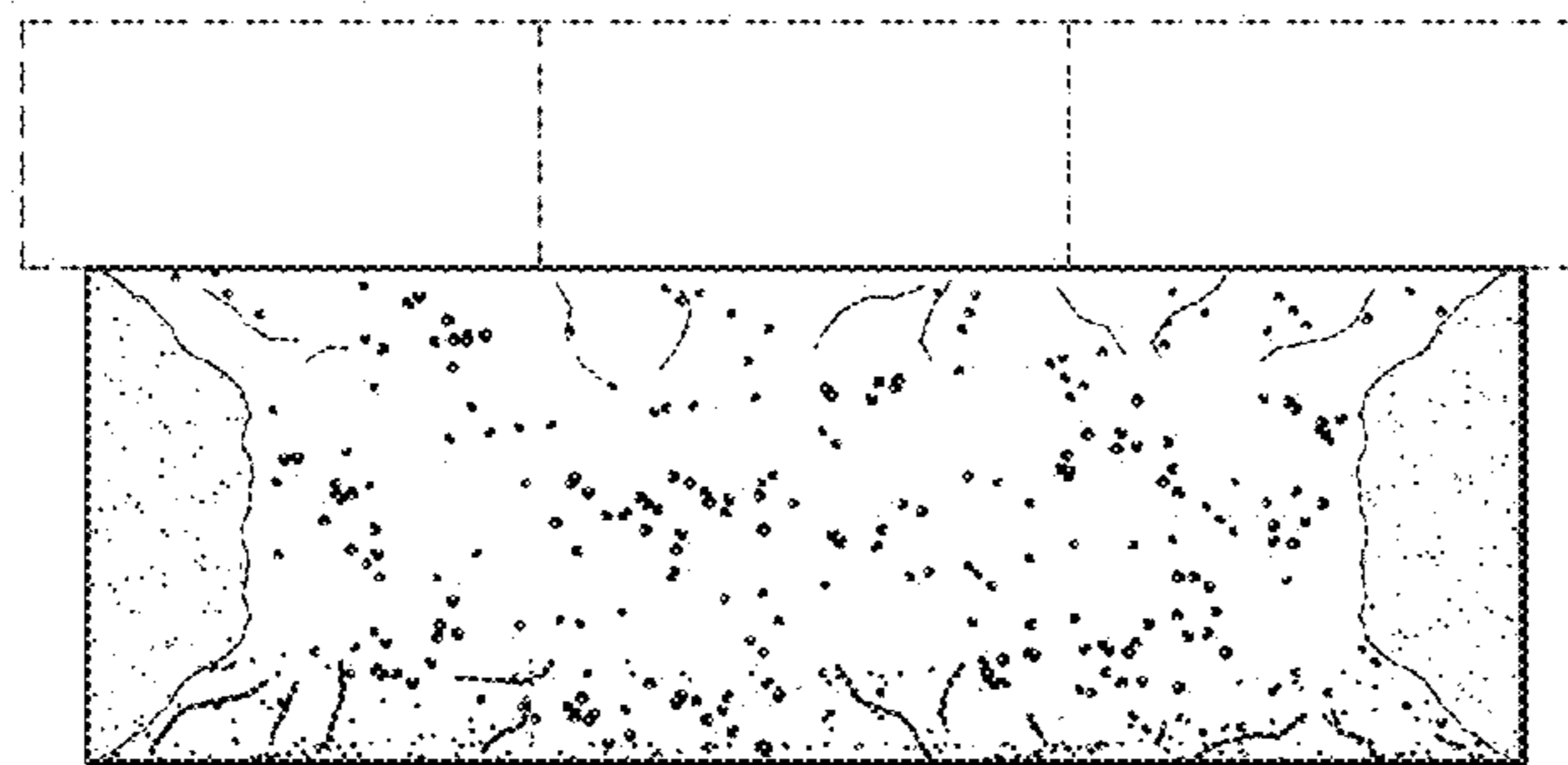

FIG. 2

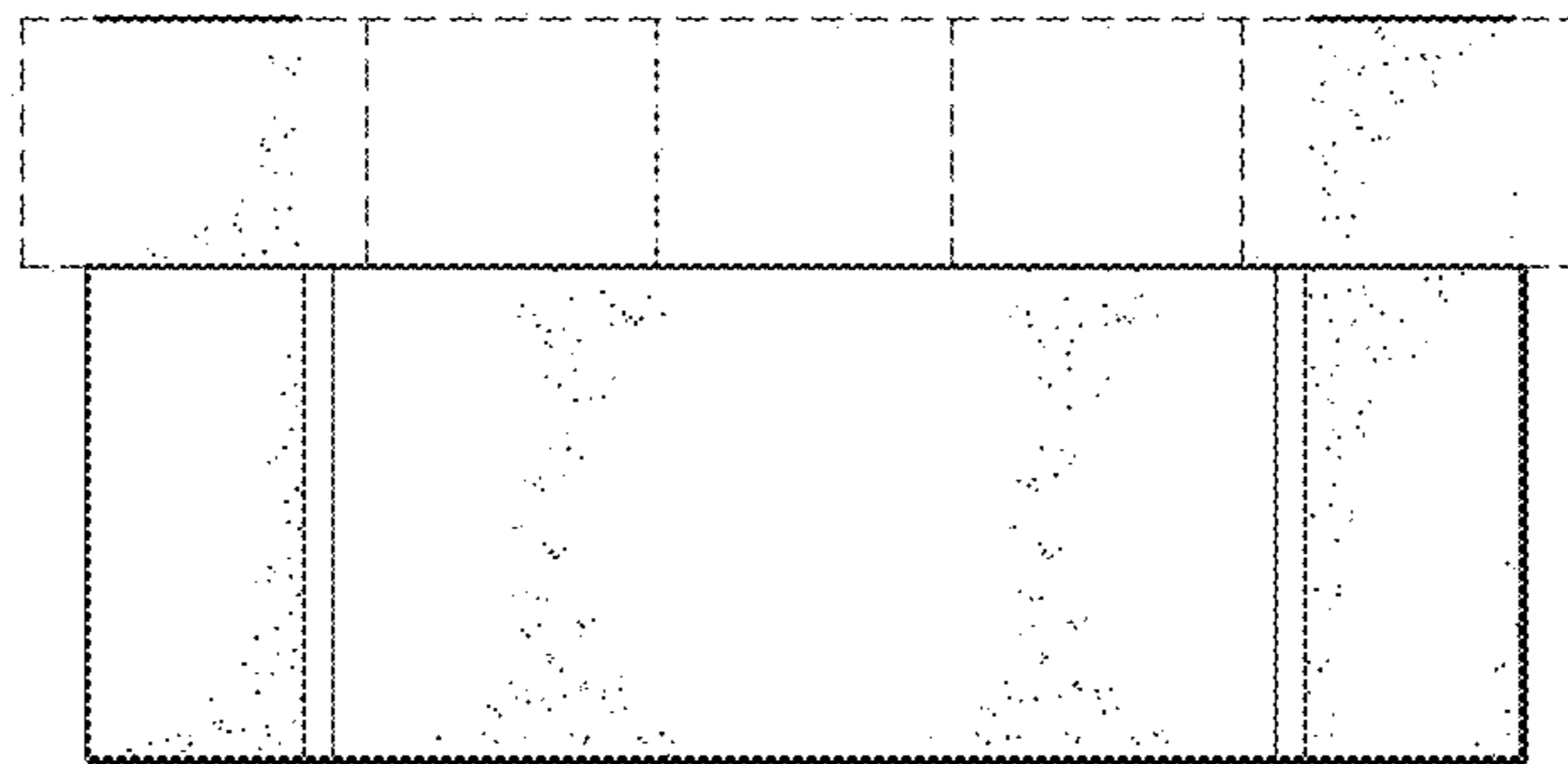

FIG. 3

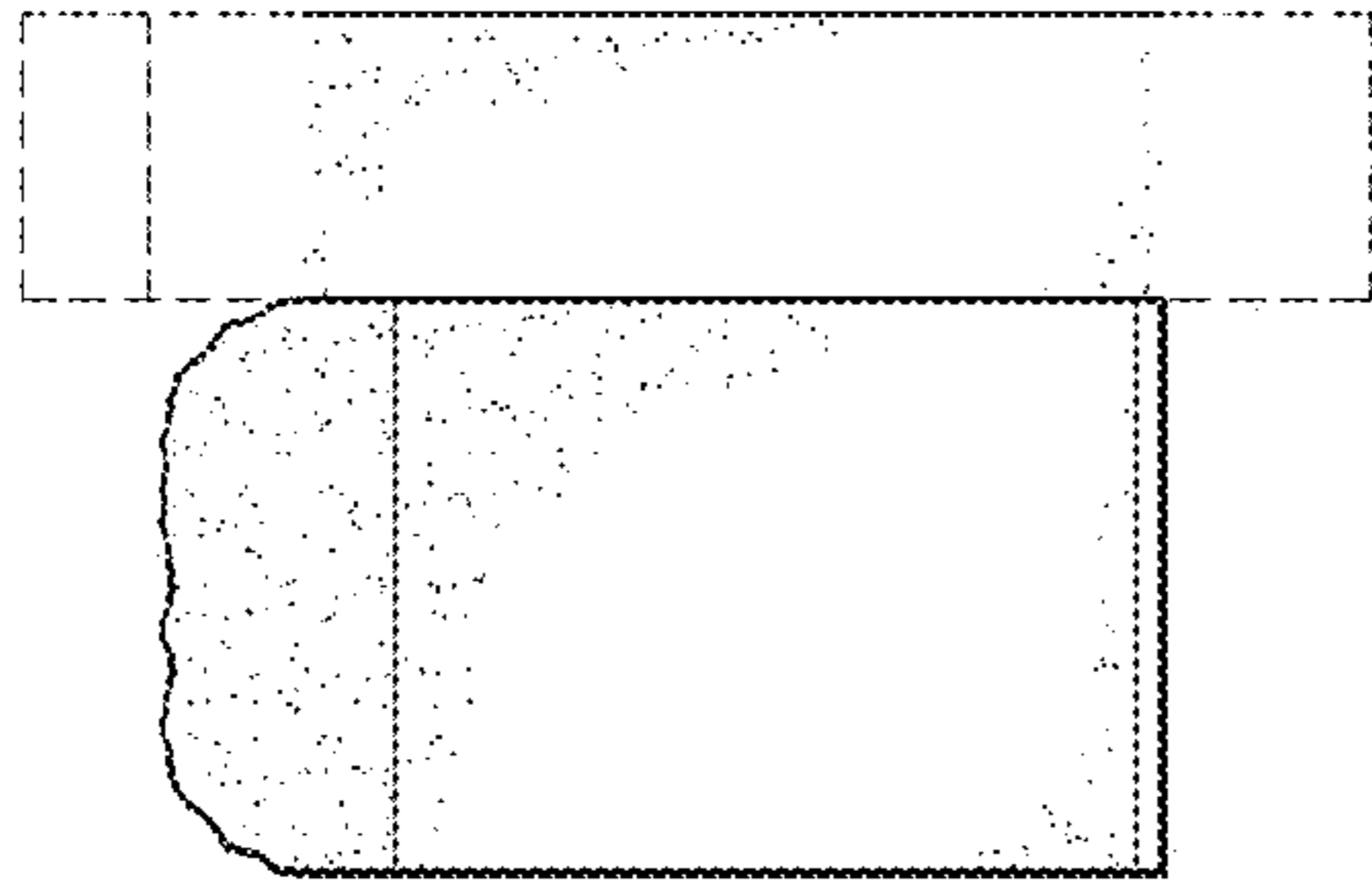

FIG. 4

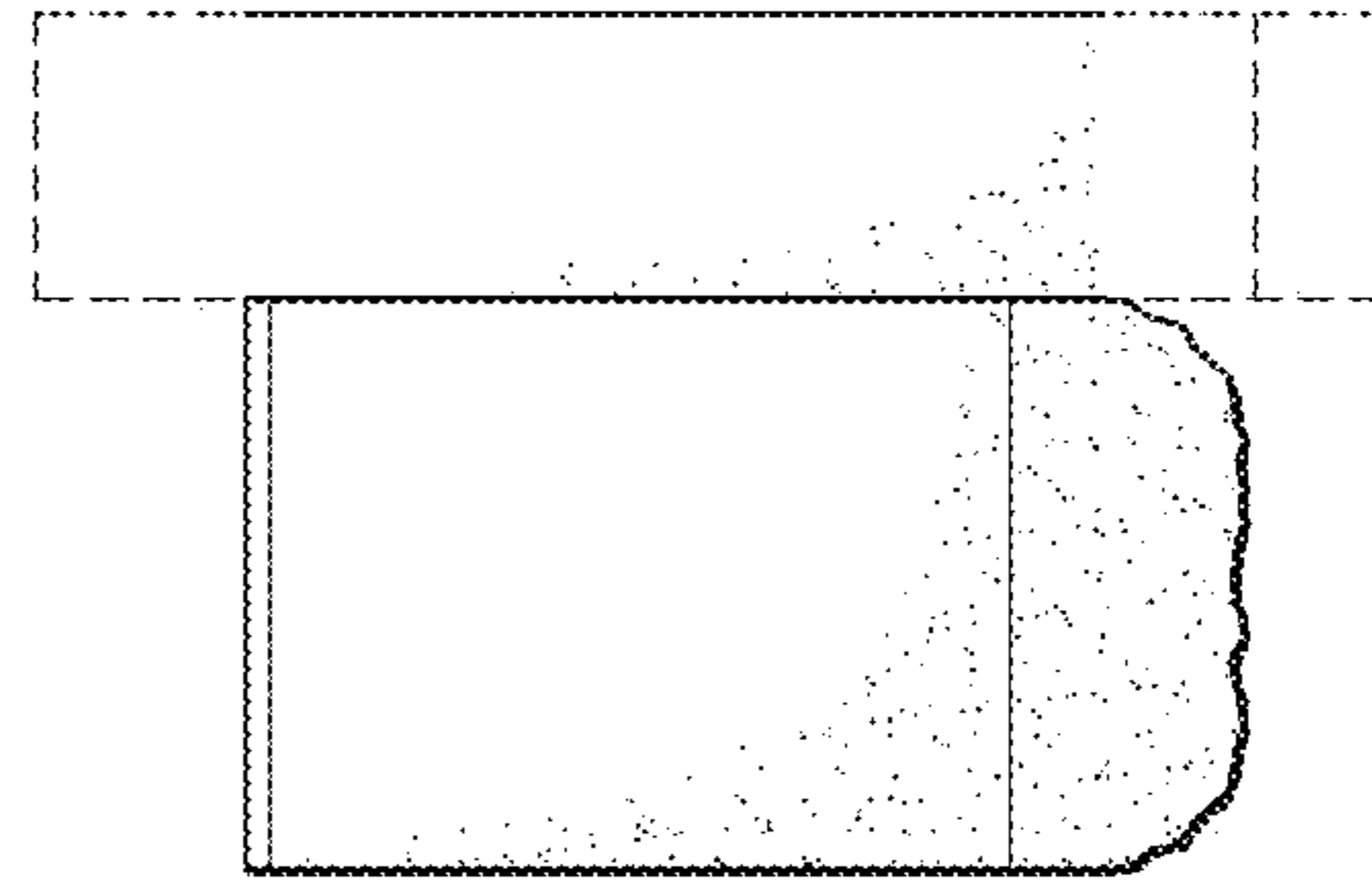

FIG. 5

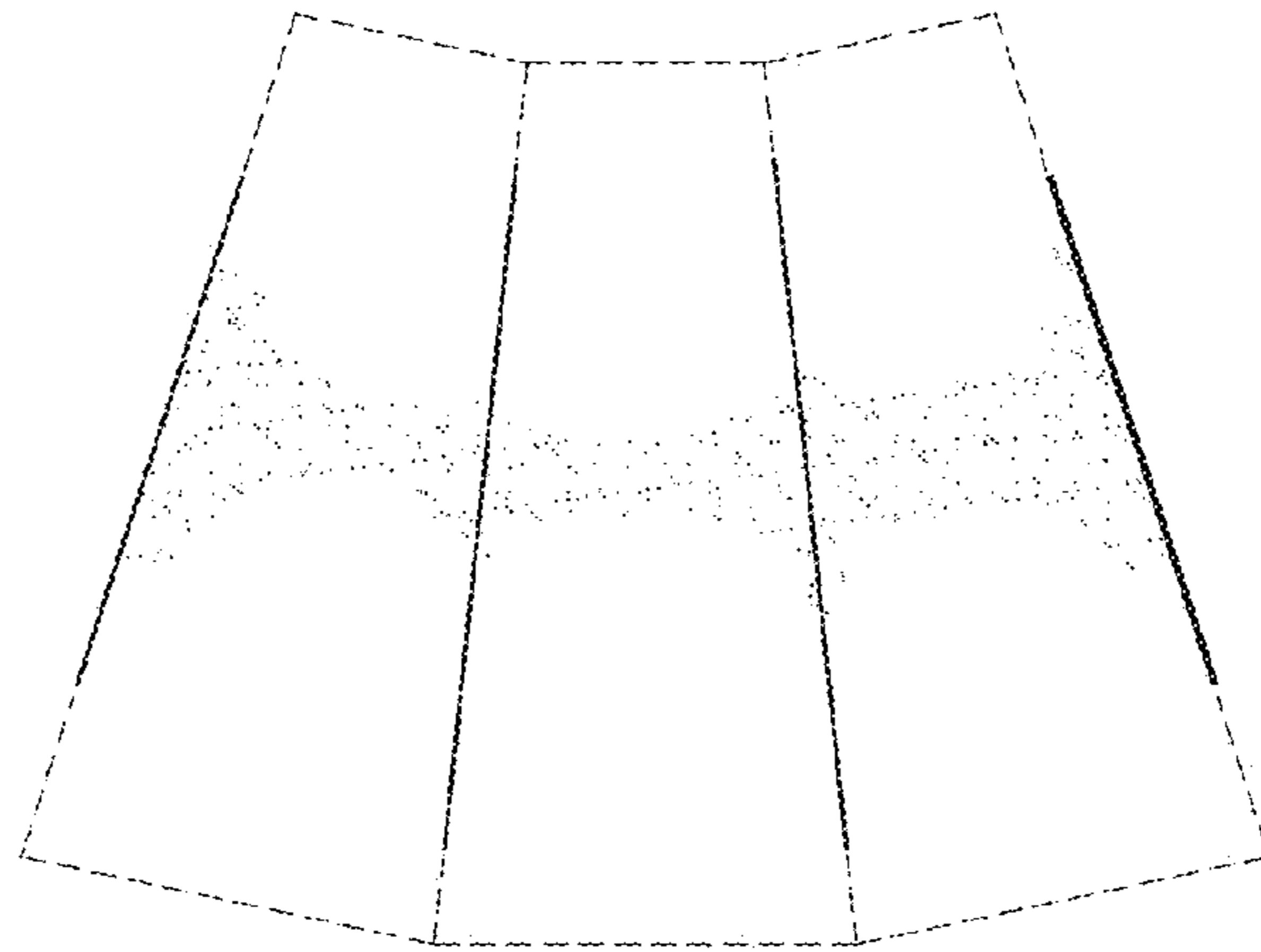

FIG. 6

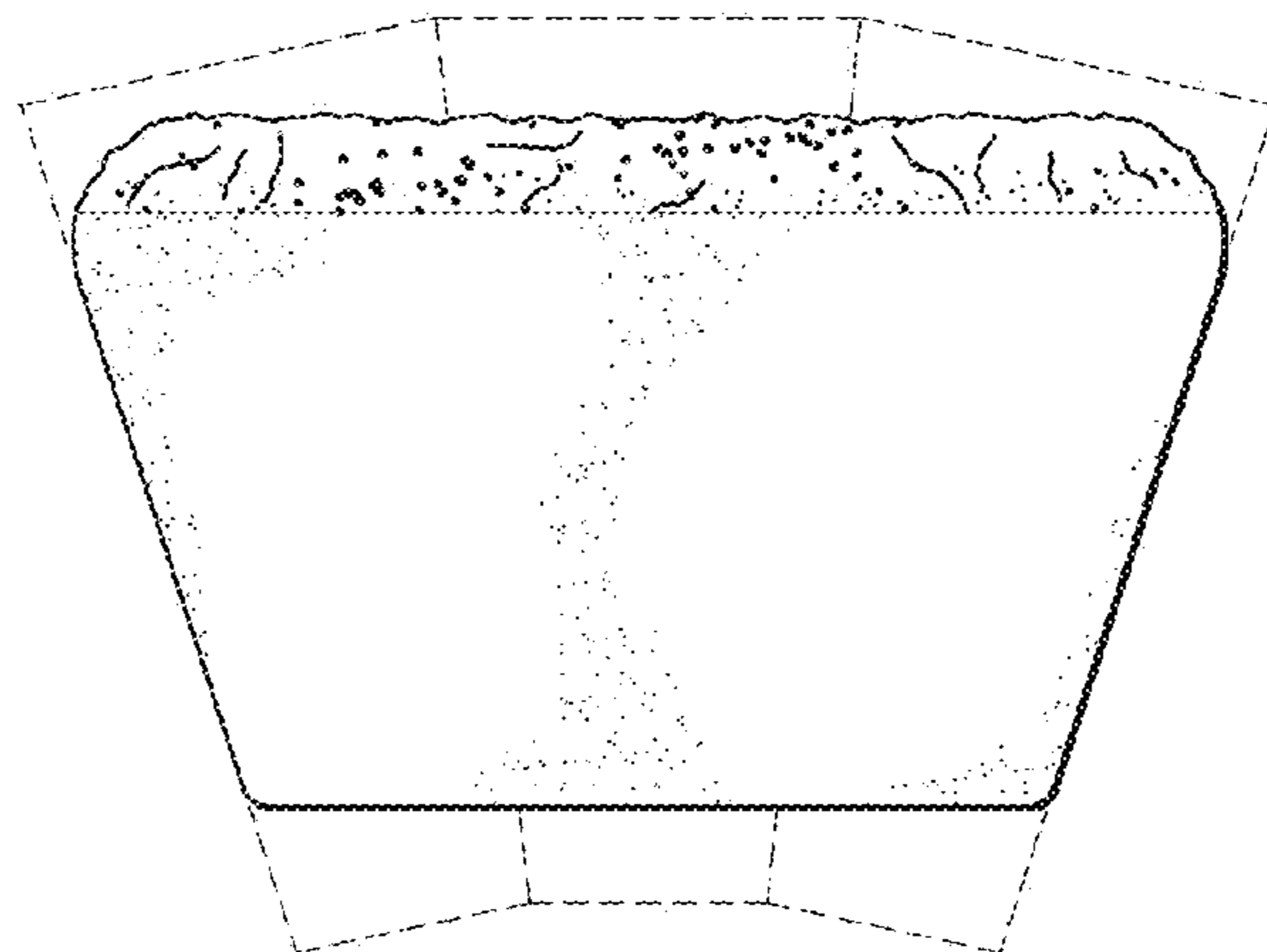

FIG. 7