



US00D731675S

(12) **United States Design Patent**
Karau

(10) **Patent No.:** **US D731,675 S**
(45) **Date of Patent:** **** Jun. 9, 2015**

- (54) **FRONT PORTION OF A RETAINING WALL**
- (71) Applicant: **PAVESTONE, LLC**, Atlanta, GA (US)
- (72) Inventor: **William H. Karau**, Southlake, TX (US)
- (73) Assignee: **PAVESTONE, LLC**, Atlanta, GA (US)
- (**) Term: **14 Years**
- (21) Appl. No.: **29/490,221**
- (22) Filed: **May 7, 2014**
- (51) **LOC (10) Cl.** **25-01**
- (52) **U.S. Cl.**
USPC **D25/113**
- (58) **Field of Classification Search**
USPC D25/113–118, 164, 102, 138, 149, 152,
D25/153, 199; D21/484–491, 499–504;
405/16, 284, 286; 52/503–505, 574,
52/575, 596–612, 592.6, 561, 566;
404/27–42; D8/1
See application file for complete search history.

- D555,810 S * 11/2007 Strand D25/118
- D598,136 S * 8/2009 Mugge D25/113
- 2007/0289247 A1 * 12/2007 Hamel 52/596
- 2011/0318100 A1 * 12/2011 Rainey 404/6
- 2014/0270988 A1 * 9/2014 Riccobene et al. 405/284

* cited by examiner

Primary Examiner — Anhdao Doan

(74) *Attorney, Agent, or Firm* — Jackson Walker L.L.P.;
Christopher J. Rourk

(57) **CLAIM**

The ornamental design for a front portion of a retaining wall,
as shown and described.

DESCRIPTION

FIG. 1 shows a perspective view of a retaining wall;
 FIG. 2 shows a front view of the retaining wall illustrated in
 FIG. 1;
 FIG. 3 shows a back view of the retaining wall illustrated in
 FIG. 1;
 FIG. 4 shows a right side view of the retaining wall illustrated
 in FIG. 1;
 FIG. 5 shows a left side view of the retaining wall illustrated
 in FIG. 1;
 FIG. 6 shows a top view of the retaining wall illustrated in
 FIG. 1; and,
 FIG. 7 shows a bottom view of the retaining wall illustrated in
 FIG. 1.
 The broken lines in the drawing views are included for the
 purpose of illustrating portions of the retaining wall that form
 no part of the claimed design.

1 Claim, 4 Drawing Sheets

(56) **References Cited**

U.S. PATENT DOCUMENTS

- D397,230 S * 8/1998 Forsberg D25/114
- 5,865,005 A * 2/1999 Cataldo 52/598
- D431,656 S * 10/2000 Pardo D25/113
- D435,302 S * 12/2000 Blomquist et al. D25/113
- D477,091 S * 7/2003 Manthei D25/113
- D477,419 S * 7/2003 Manthei D25/113

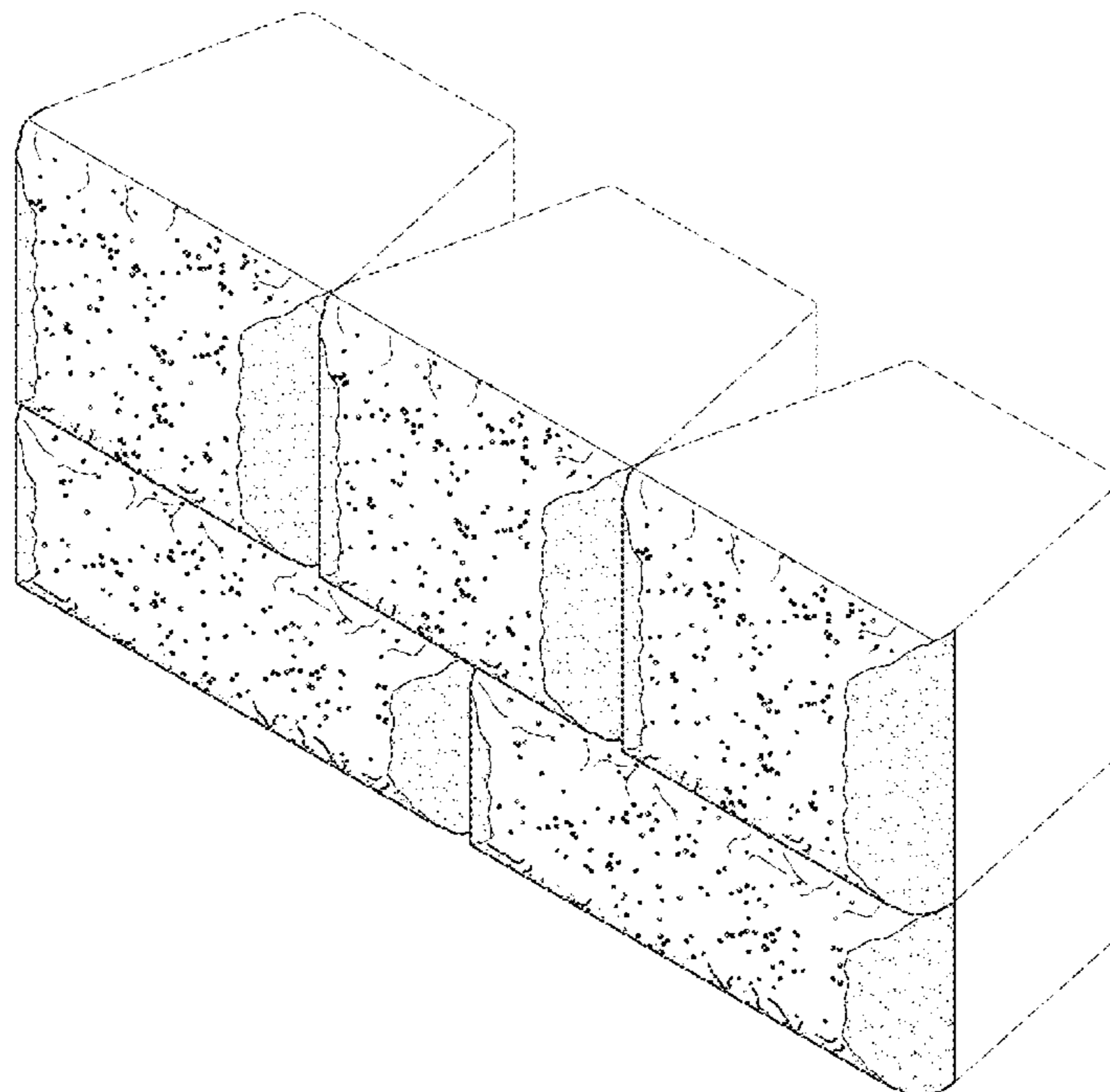

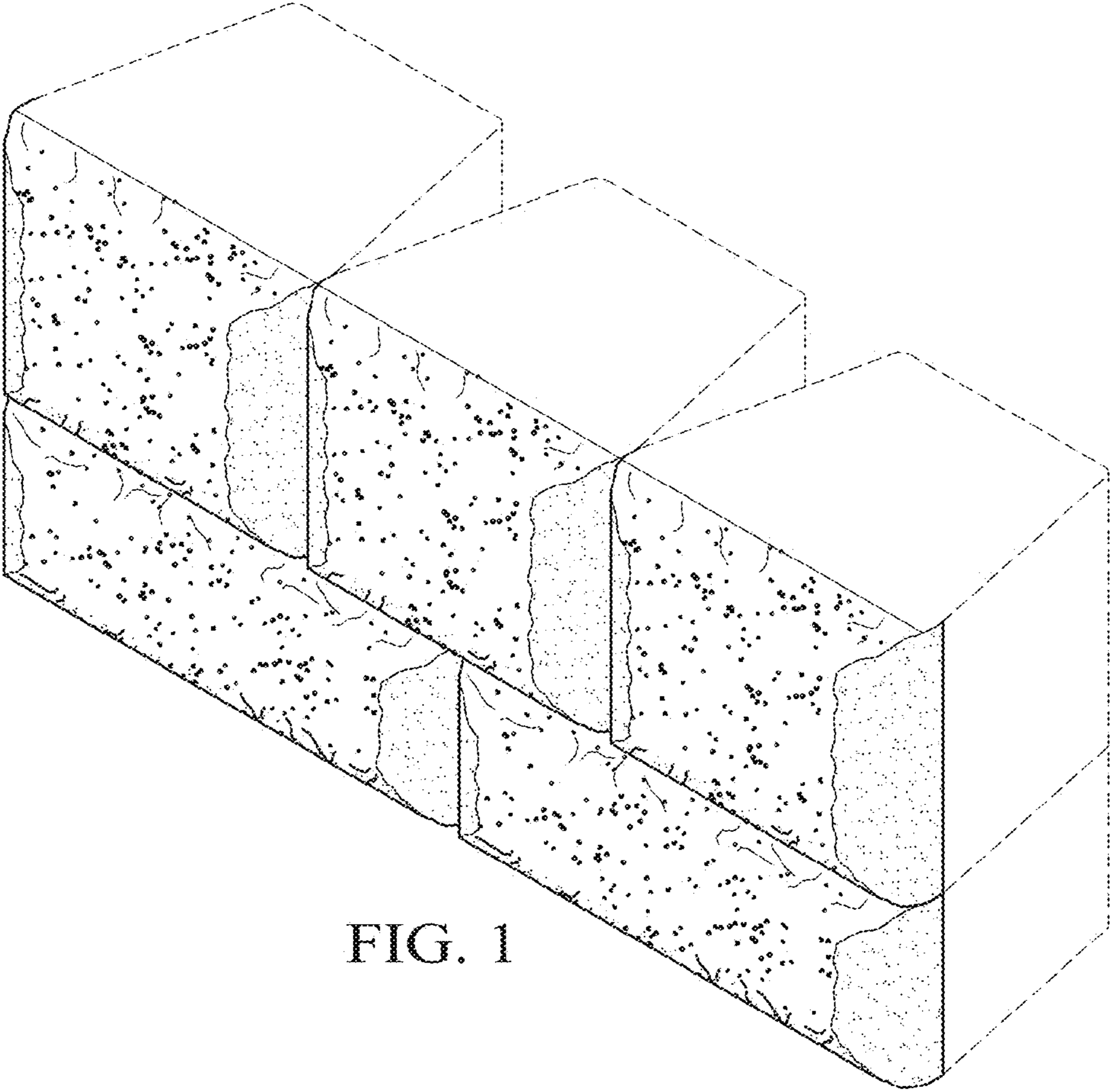

FIG. 1

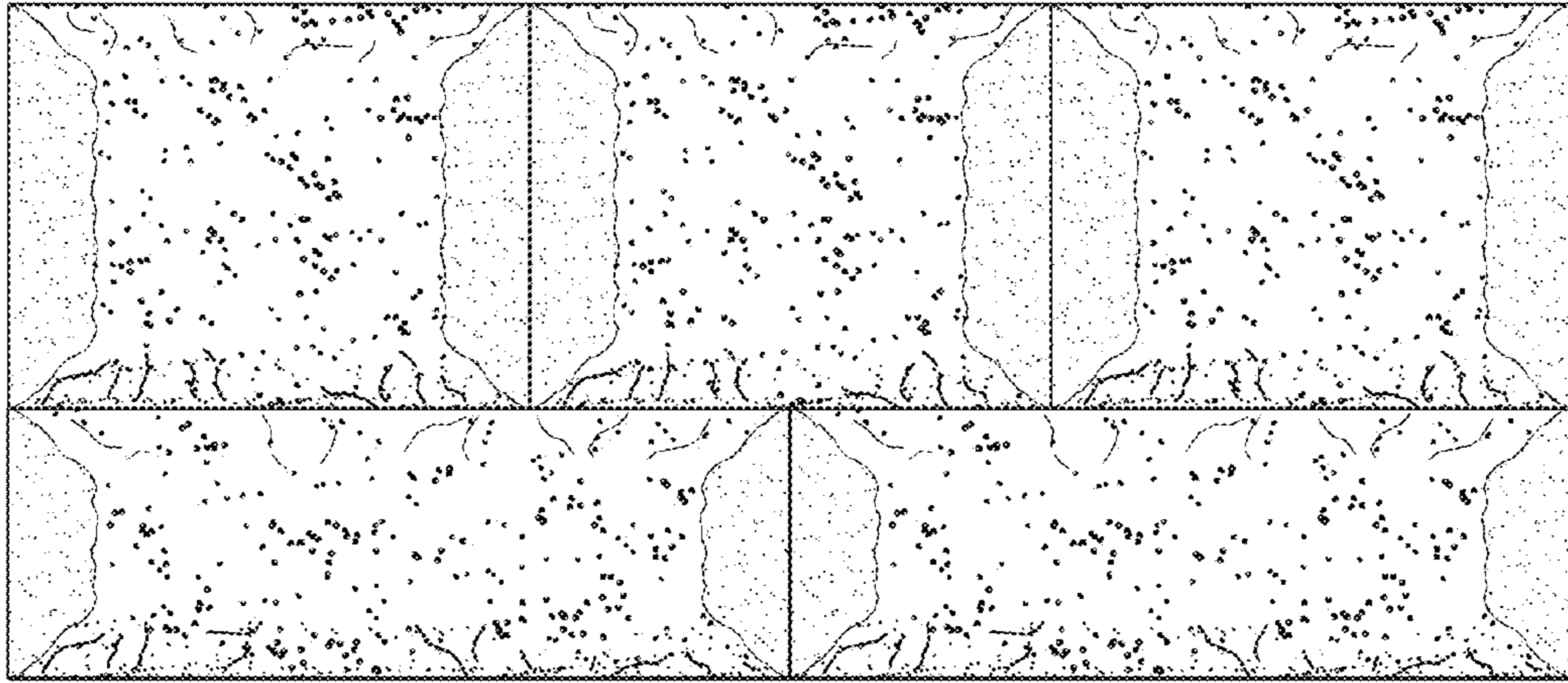

FIG. 2

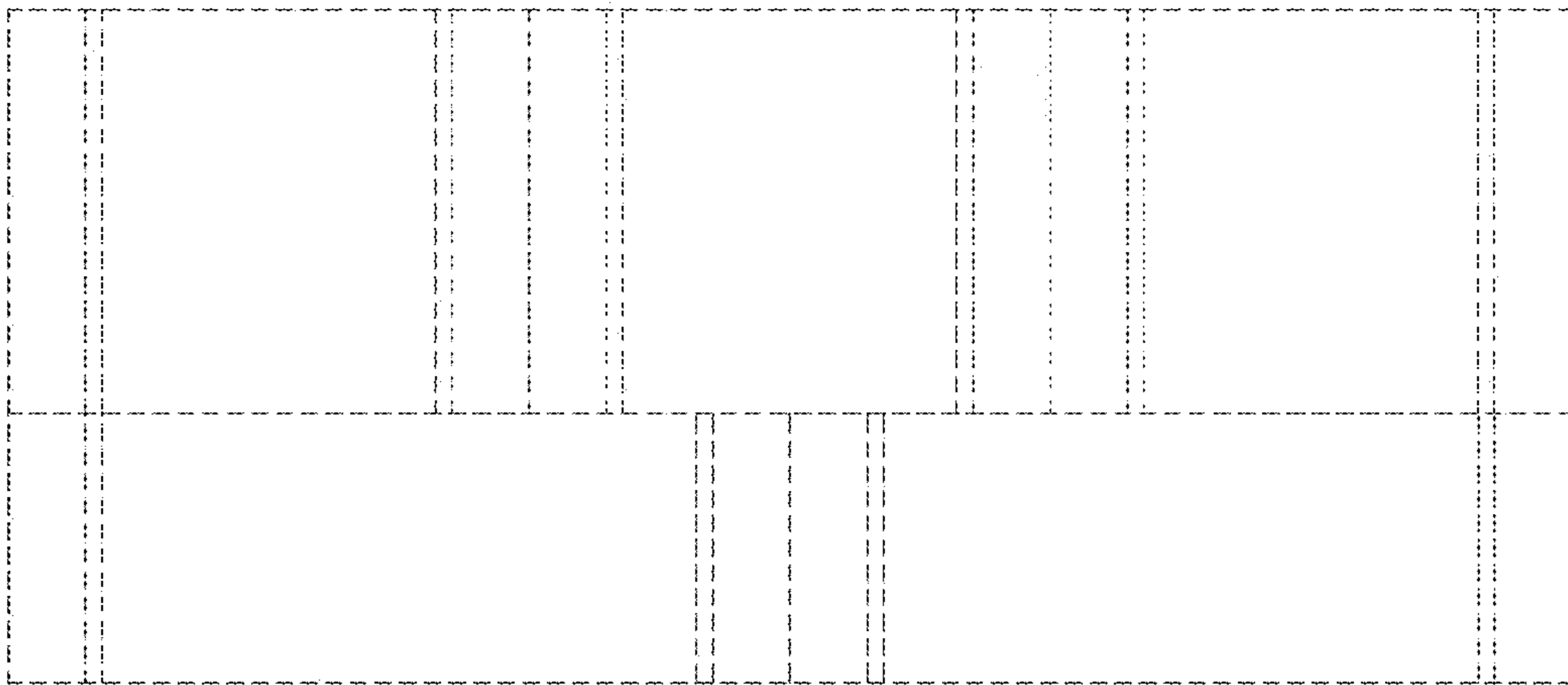

FIG. 3

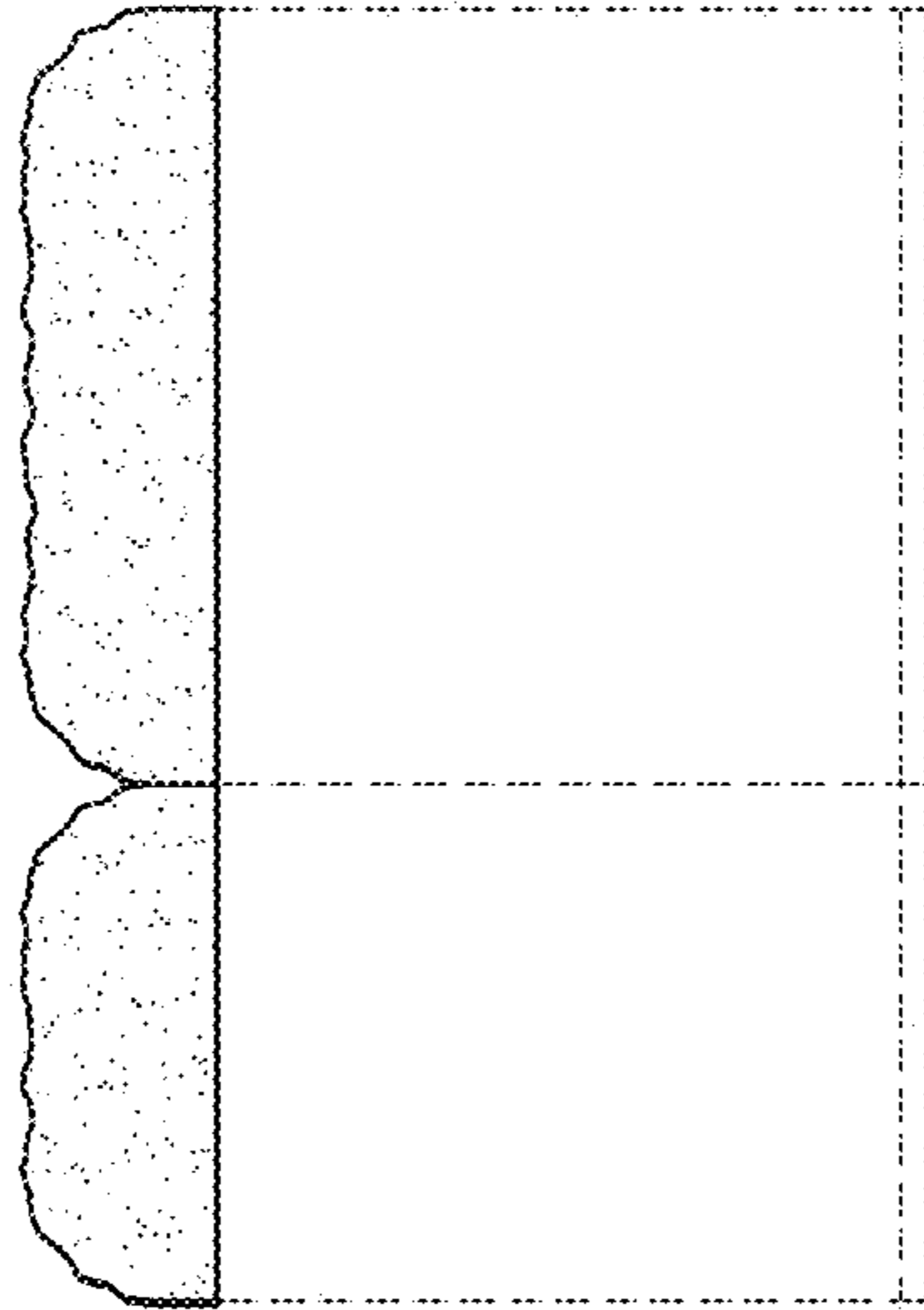

FIG. 4

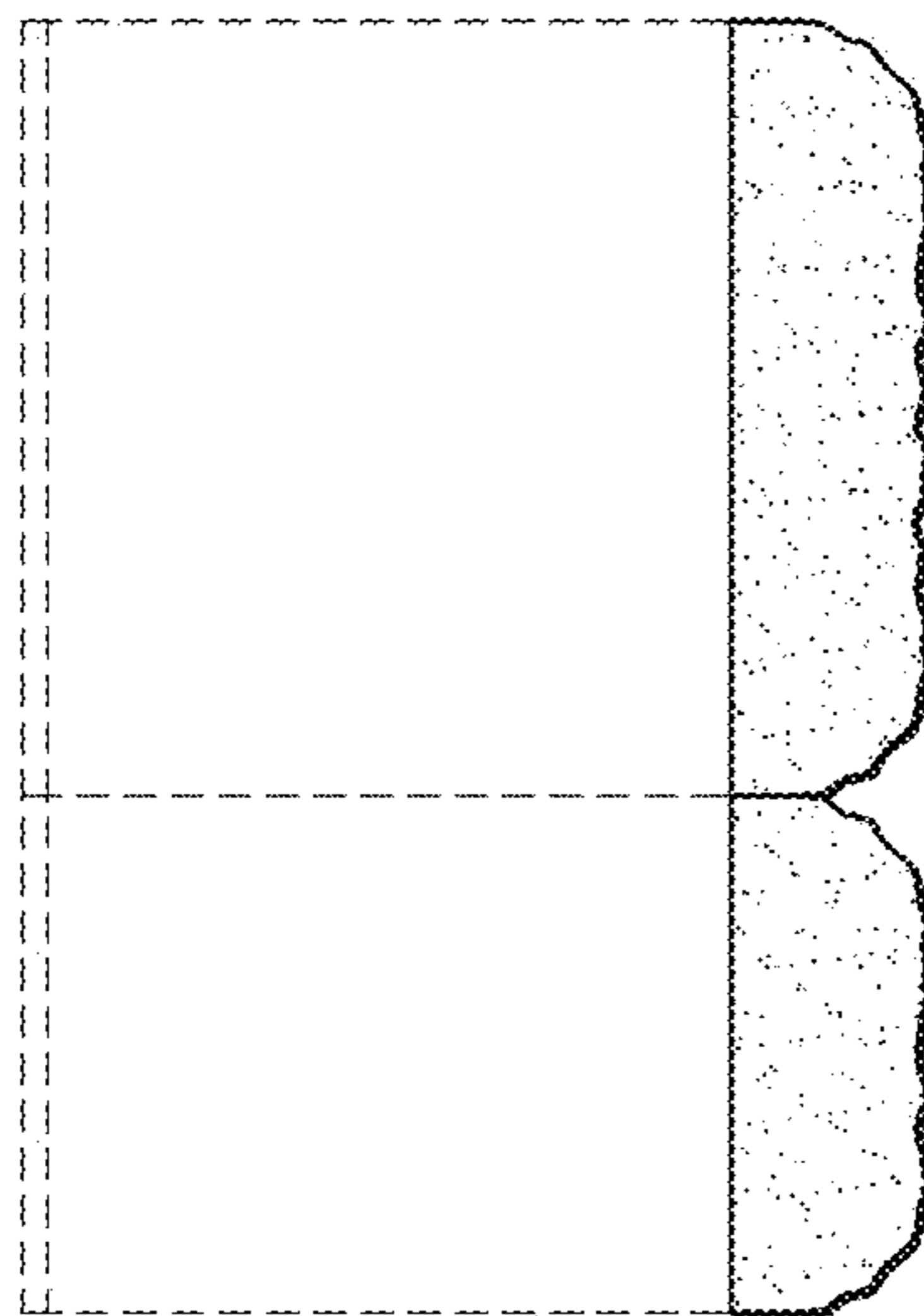

FIG. 5

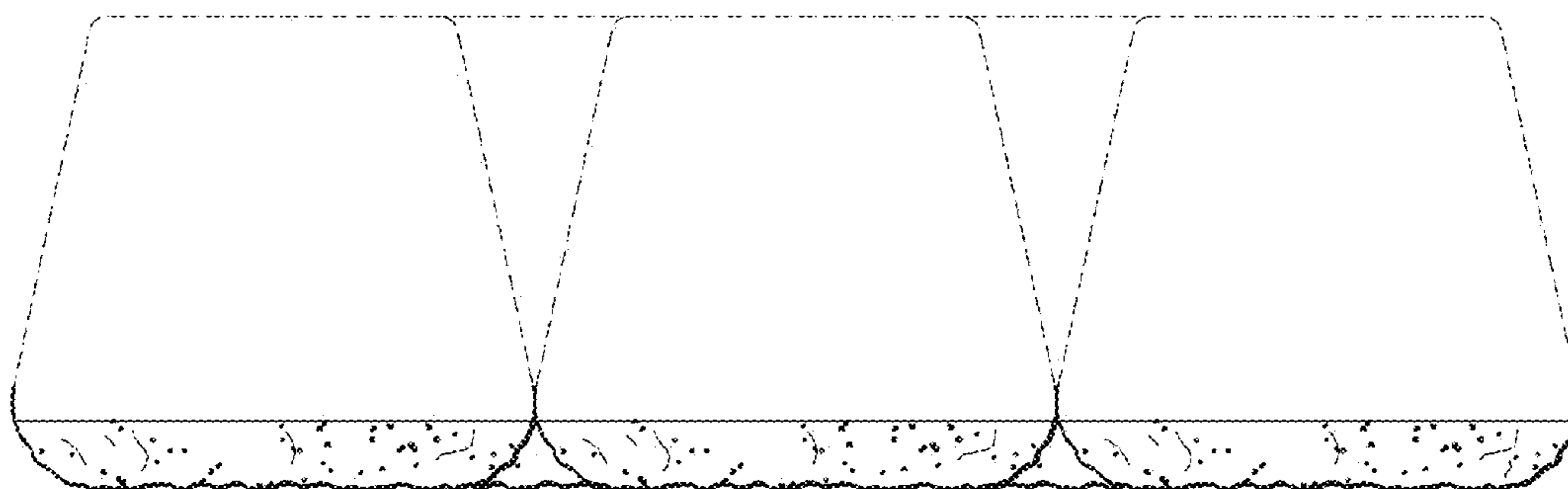

FIG. 6

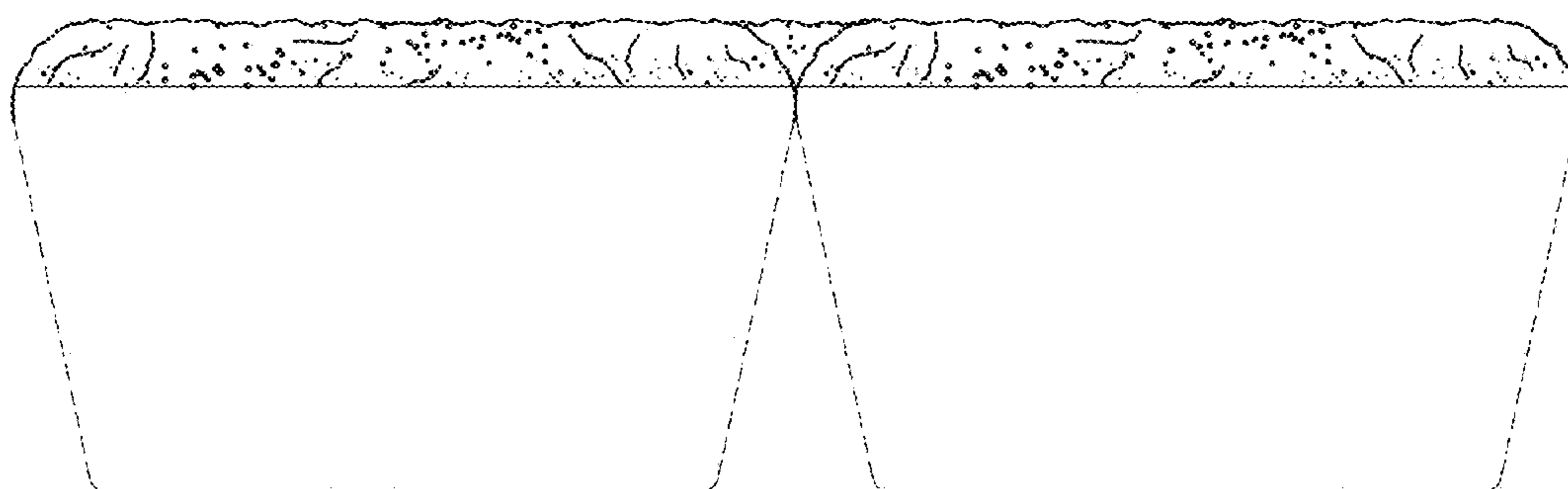

FIG. 7