



US00D731638S

(12) **United States Design Patent**  
**Bevis**

(10) **Patent No.:** **US D731,638 S**  
(45) **Date of Patent:** **\*\* Jun. 9, 2015**

(54) **NASAL ASPIRATOR ASSEMBLY**

(71) Applicant: **SKUNKWORKS3RESEARCH, INC.**,  
Monroe, NC (US)

(72) Inventor: **Thomas L. Bevis**, Monroe, NC (US)

(73) Assignee: **SKUNKWORKS3RESEARCH, INC.**,  
Monroe, NC (US)

(\*\*) Term: **14 Years**

(21) Appl. No.: **29/435,417**

(22) Filed: **Oct. 24, 2012**

(51) **LOC (10) Cl.** ..... **29-02**

(52) **U.S. Cl.**  
USPC ..... **D24/110**

(58) **Field of Classification Search**  
USPC ..... D24/108, 110, 111, 110.5; 604/30, 73,  
604/94.01, 121, 125, 151, 275; 222/211,  
222/212

See application file for complete search history.

(56) **References Cited**

U.S. PATENT DOCUMENTS

830,889 A 9/1906 Davol  
944,252 A 12/1909 Bassler

(Continued)

OTHER PUBLICATIONS

<http://nasalaspirator.co.uk/node/14> (3 pages).

*Primary Examiner* — Barbara Fox

*Assistant Examiner* — Lilyana Bekic

(74) *Attorney, Agent, or Firm* — Saliwanchik, Lloyd & Eisenschenk

(57) **CLAIM**

The ornamental design for a nasal aspirator assembly, as shown and described.

**DESCRIPTION**

FIG. 1 is a bottom perspective exploded view of a nasal aspirator assembly showing the new design, showing an

adaptor piece and a first embodiment of a nose piece and a second embodiment of a nose piece separately for ease of illustration.

FIG. 2 is a front elevation view of the body piece of the nasal aspirator assembly shown separately for ease of illustration; FIG. 3 is a rear elevation view thereof;

FIG. 4 is a right side elevation view thereof;

FIG. 5 is a left side elevation view thereof;

FIG. 6 is a top plan view thereof;

FIG. 7 is a top right perspective view thereof;

FIG. 8 is a bottom right perspective view thereof; and

FIG. 9 is a bottom plan view thereof.

FIG. 10 is a front elevation view of the adaptor piece for the nasal aspirator assembly shown separately for ease of illustration. The rear elevation view is a mirror image thereof;

FIG. 11 is a right side elevation view thereof. The left side elevation view is a mirror image thereof;

FIG. 12 is a top plan view thereof;

FIG. 13 is a bottom plan view thereof; and

FIG. 14 is a top perspective view thereof.

FIG. 15 is a front elevation view of the first embodiment of a nose piece for the nasal aspirator assembly. The rear elevation view is a mirror image thereof;

FIG. 16 is a right elevation view thereof. The left side elevation view is a mirror image thereof;

FIG. 17 is a top plan view thereof; and

FIG. 18 is a bottom plan view thereof.

FIG. 19 is a front elevation view of the second embodiment of a nose piece for the nasal aspirator assembly. The rear elevation view is a mirror image thereof;

FIG. 20 is a right side elevation view thereof. The left side elevation view is a mirror image thereof;

FIG. 21 is a top plan view thereof; and,

FIG. 22 is a bottom plan view thereof.

The broken lines showing the tubing in FIG. 1 illustrates the environment of the claimed design and forms no part thereof.

All other broken lines illustrate portions of the nasal aspirator assembly which form no art of the claimed design.

The nasal aspirator assembly has an adaptor that can fit over a body piece, and has two different nose pieces that are interchangeable.

**1 Claim, 7 Drawing Sheets**

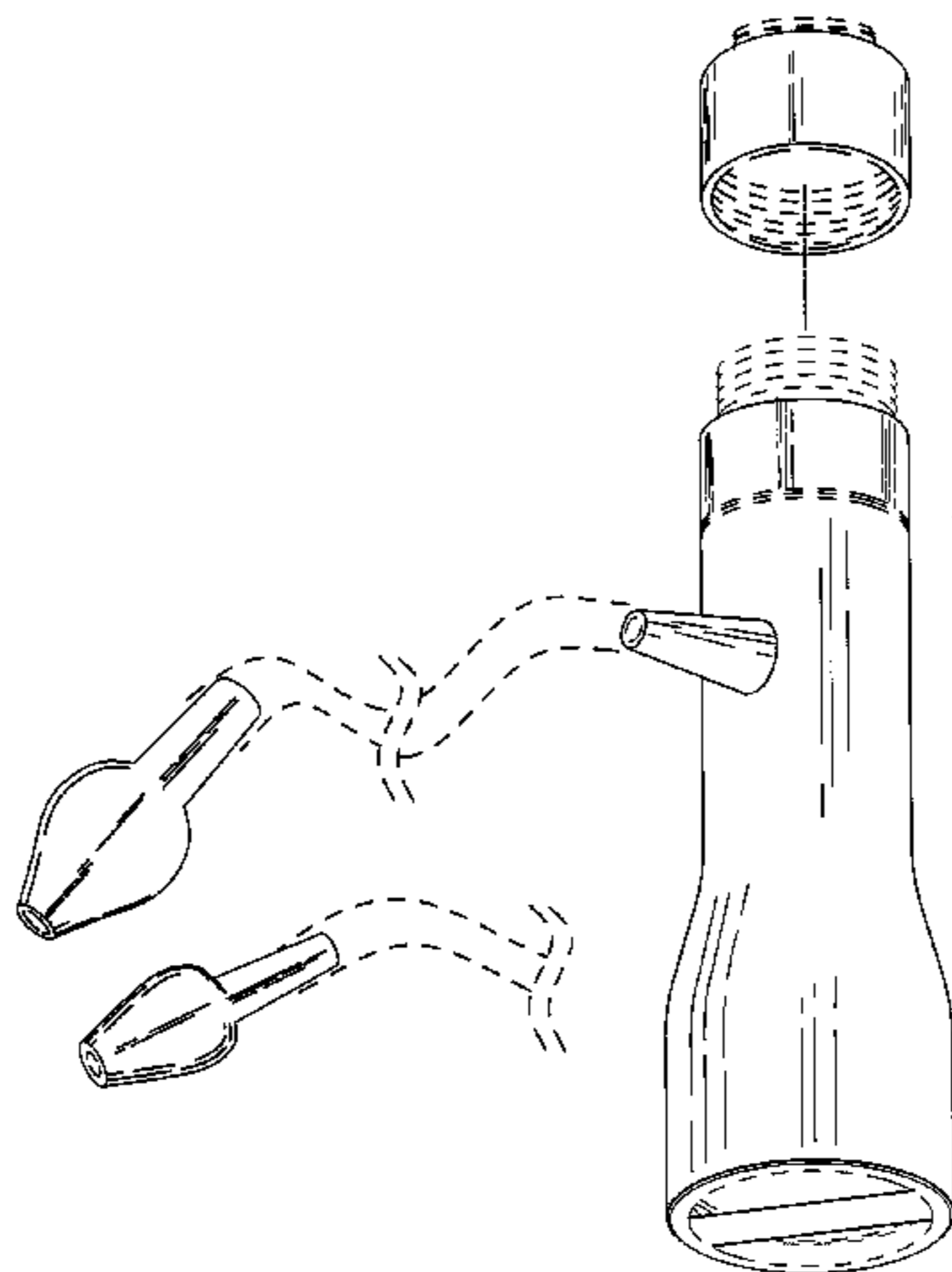

(56)

References Cited

U.S. PATENT DOCUMENTS

1,384,210	A *	7/1921	Pfaff .....	604/39	7,096,866	B2	8/2006	Be'eri et al.	
1,910,935	A	5/1933	Smith		D594,968	S *	6/2009	Sebban .....	D24/108
D92,843	S	7/1934	Gest		D629,884	S *	12/2010	Stephens .....	D24/108
D100,561	S	7/1936	Henske		7,959,597	B2 *	6/2011	Baker et al. ....	604/28
D154,209	S	6/1949	Meirink		D670,373	S *	11/2012	Taylor et al. ....	D24/108
2,511,973	A	6/1950	de la Sierra, Jr.		D671,220	S *	11/2012	Donaldson .....	D24/176
D184,914	S	4/1959	Chastain		D671,221	S *	11/2012	Donaldson .....	D24/176
5,183,467	A	2/1993	Mouney		D682,417	S *	5/2013	Csok .....	D24/108
5,752,286	A	5/1998	Wright		D690,411	S *	9/2013	Reynolds et al. ....	D24/108
					D694,398	S *	11/2013	Taylor et al. ....	D24/108
					2011/0144588	A1 *	6/2011	Taylor et al. ....	604/151
					2013/0310747	A1 *	11/2013	Lambert .....	604/149

\* cited by examiner

FIG. 1

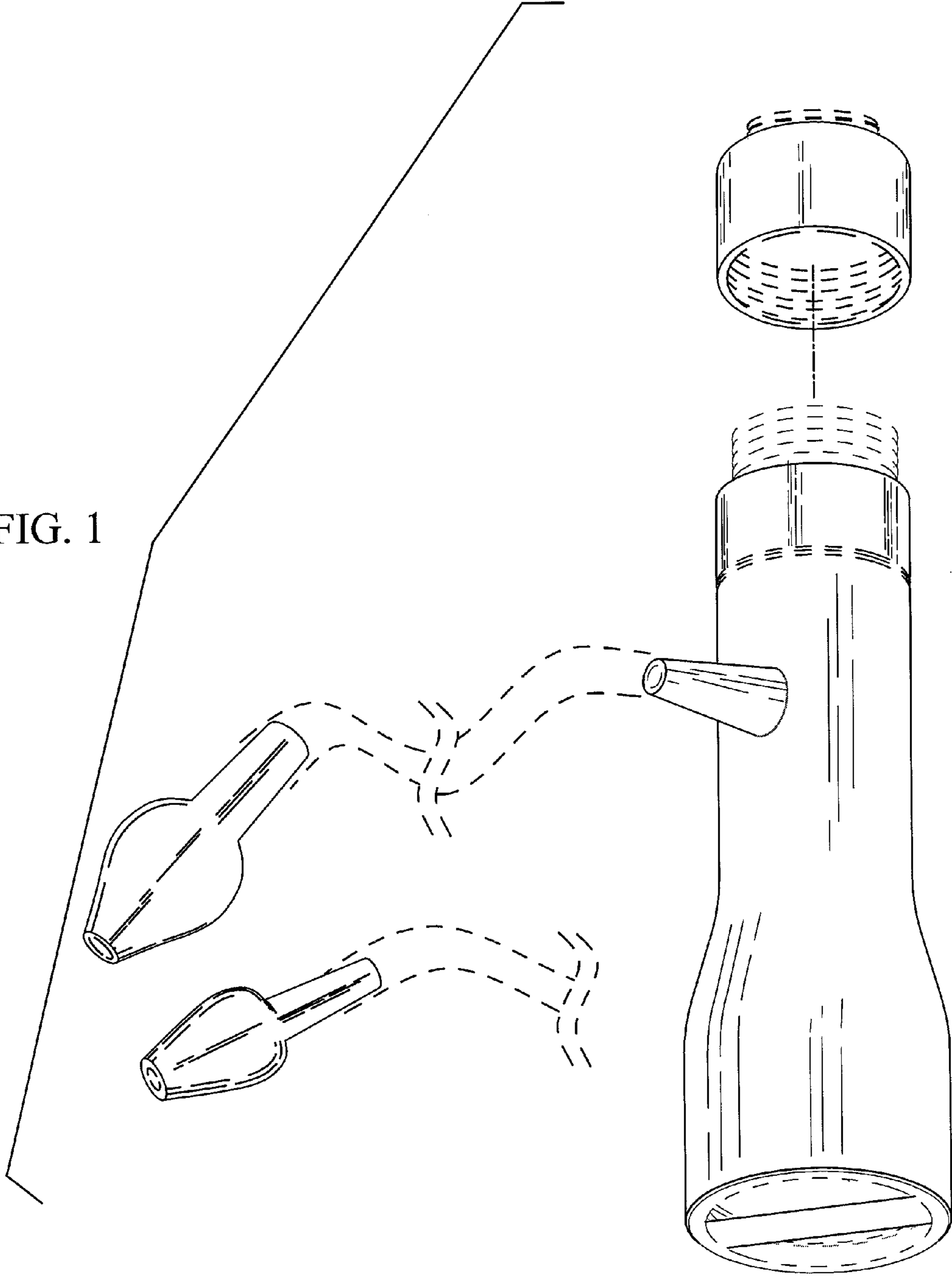

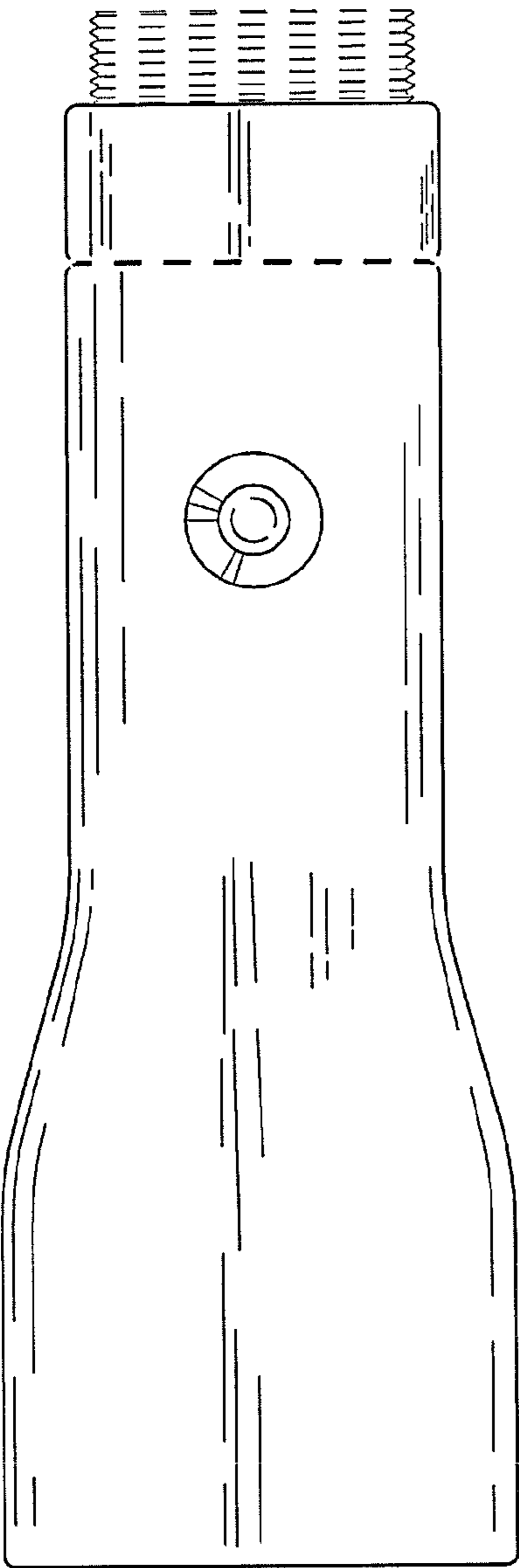

FIG. 2

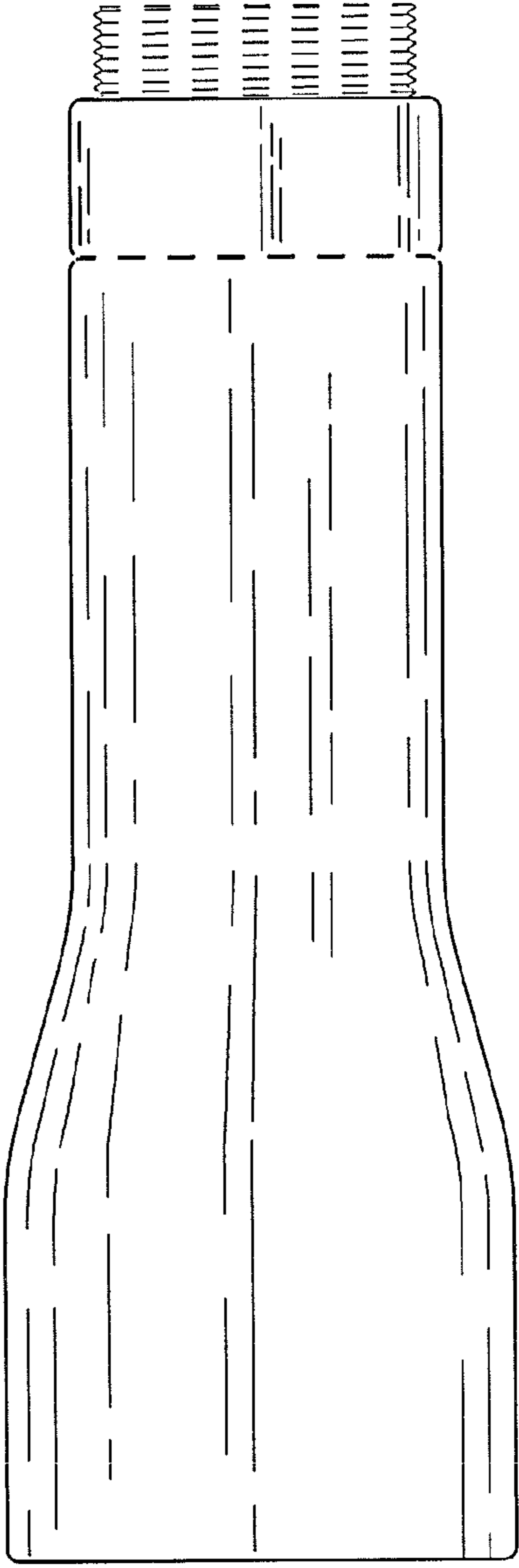

FIG. 3

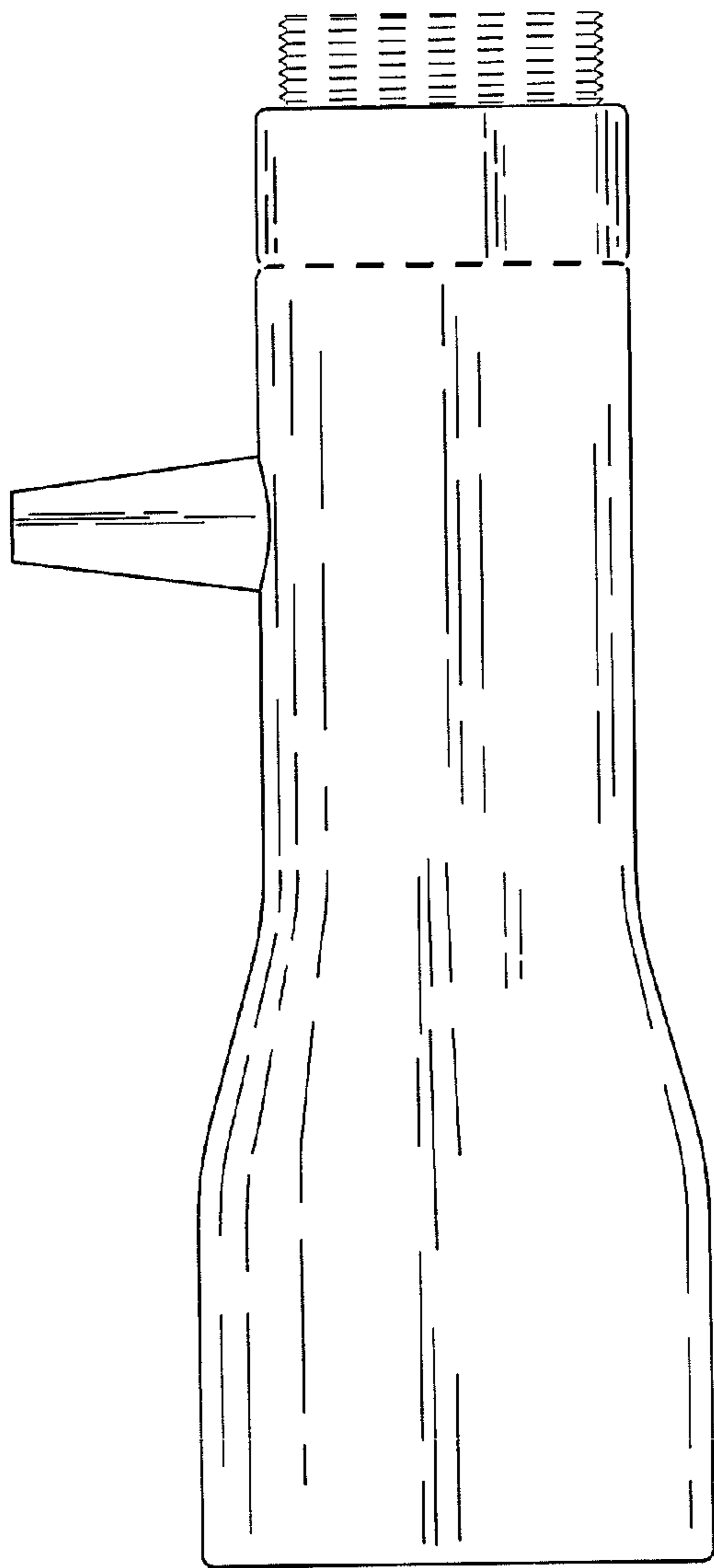

FIG. 4

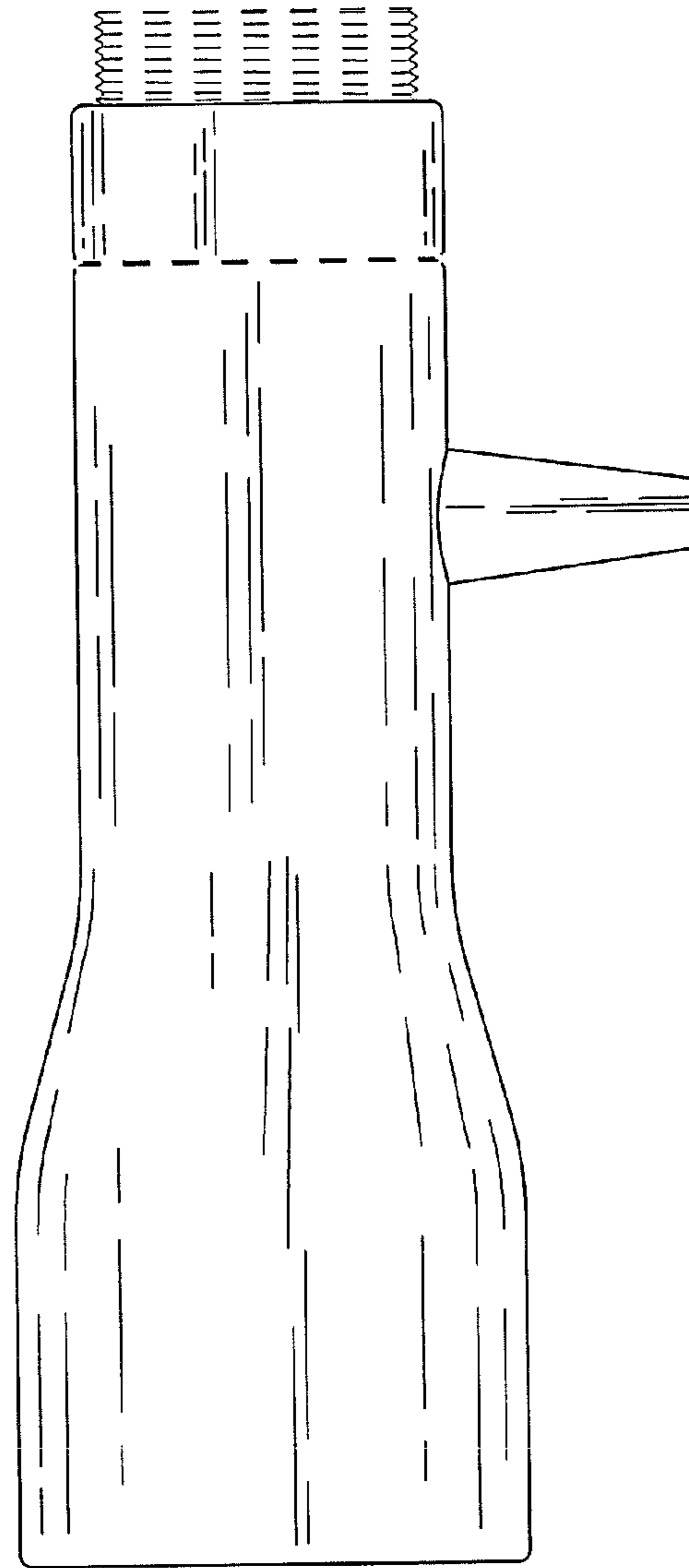

FIG. 5

FIG. 6

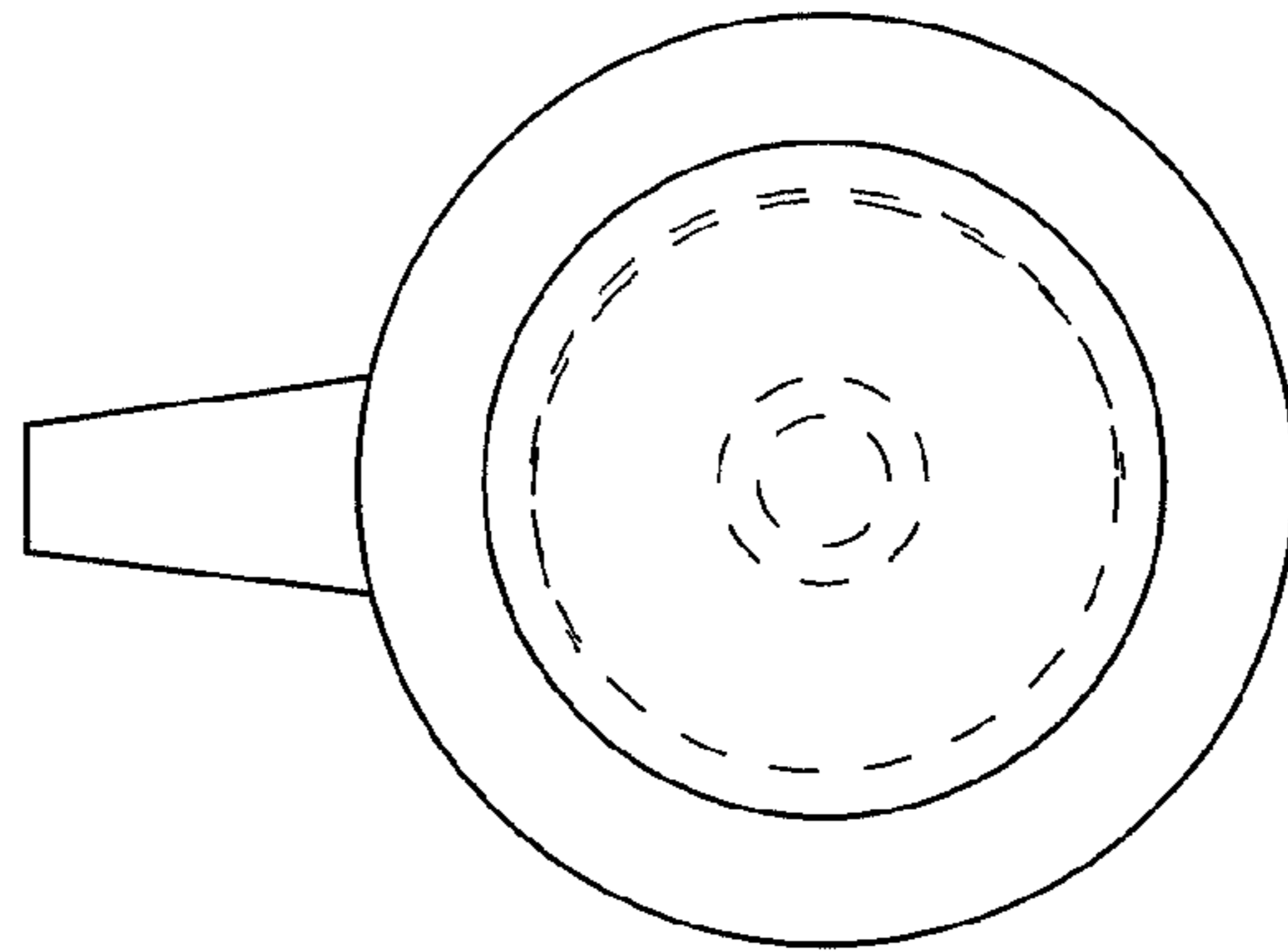

FIG. 7

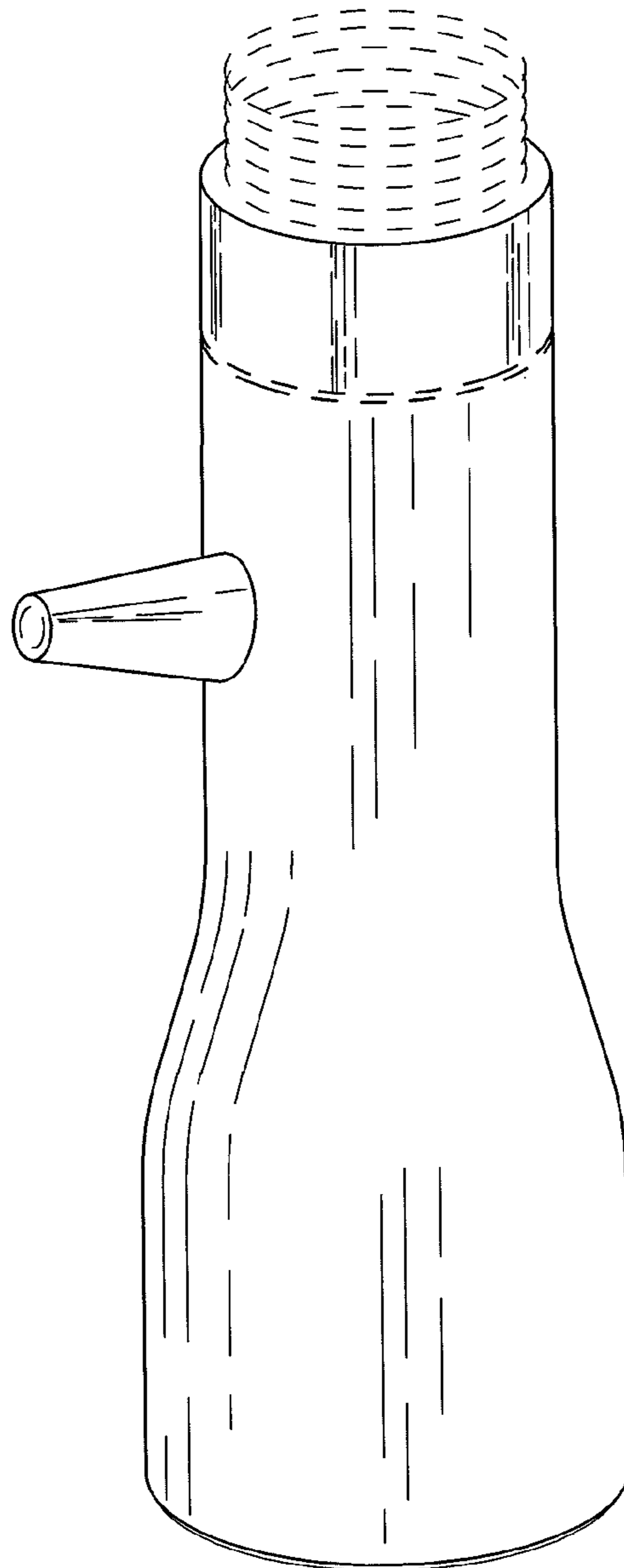

FIG. 8

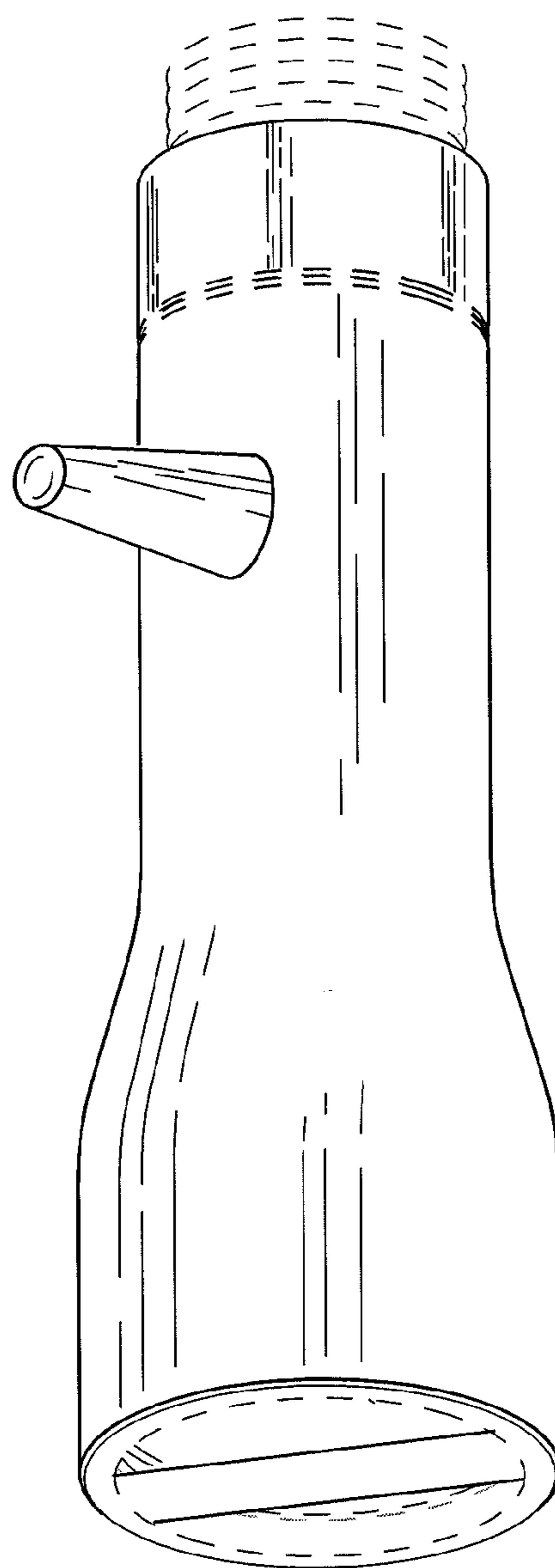
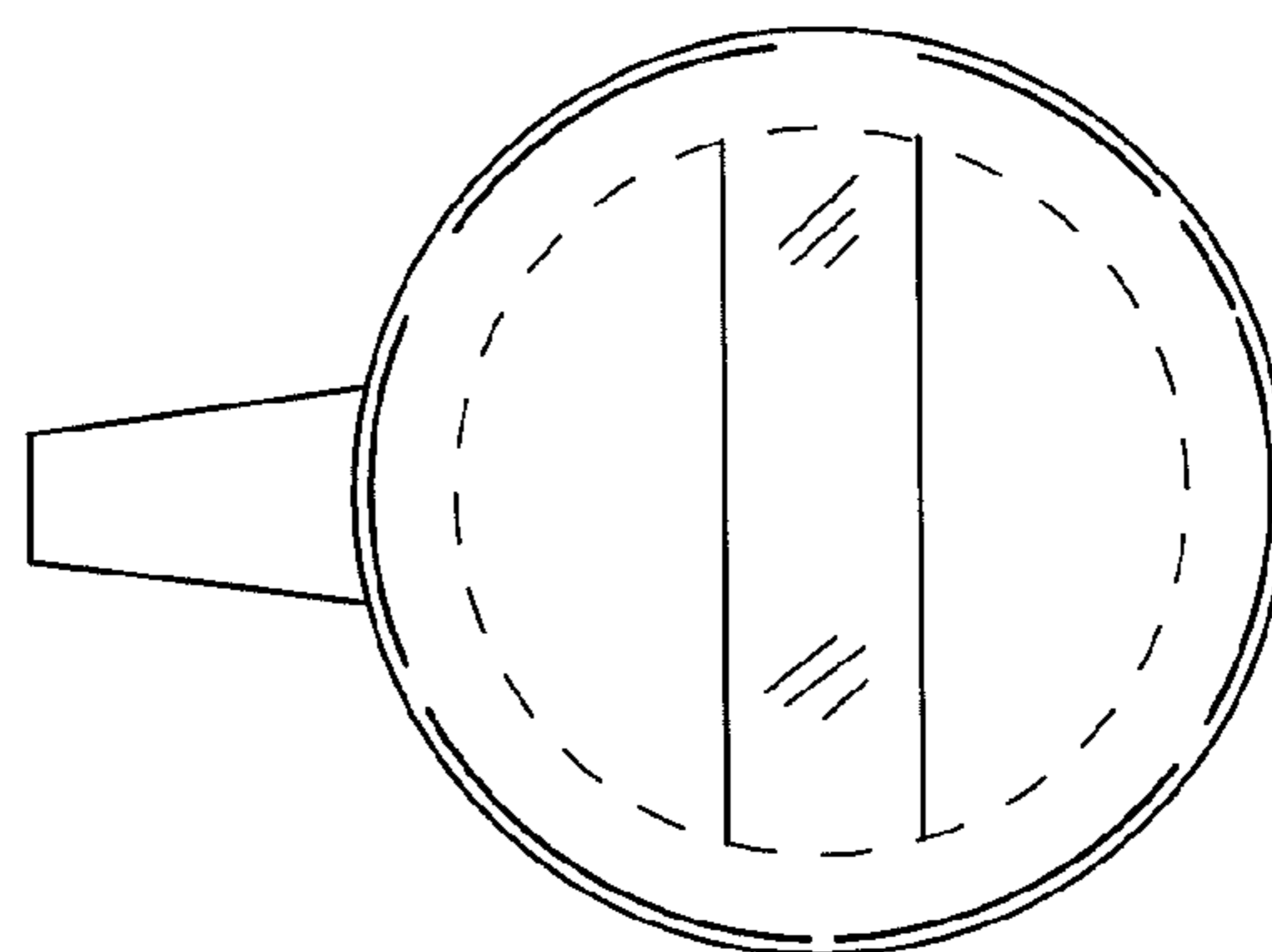

FIG. 9



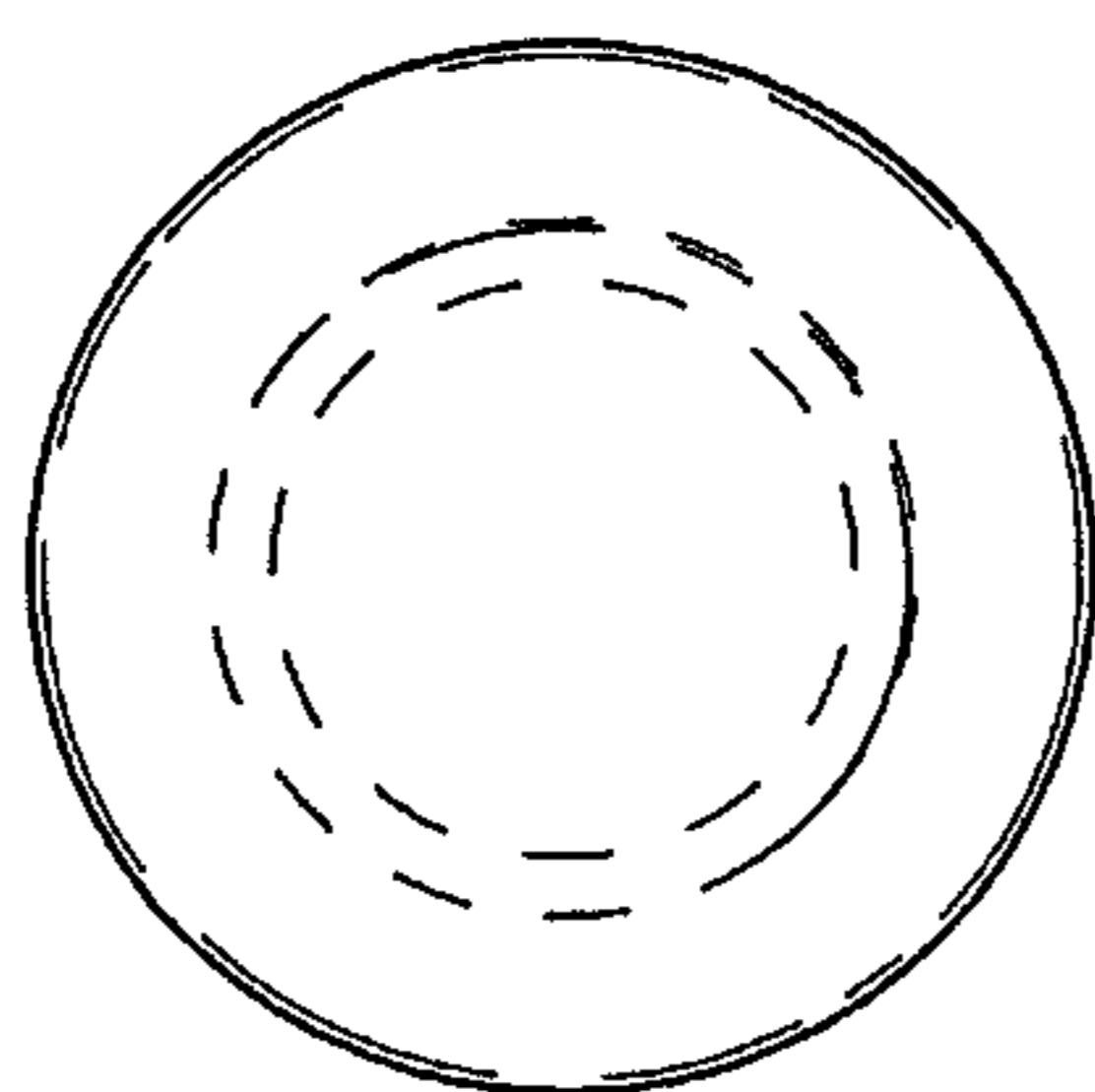

FIG. 12

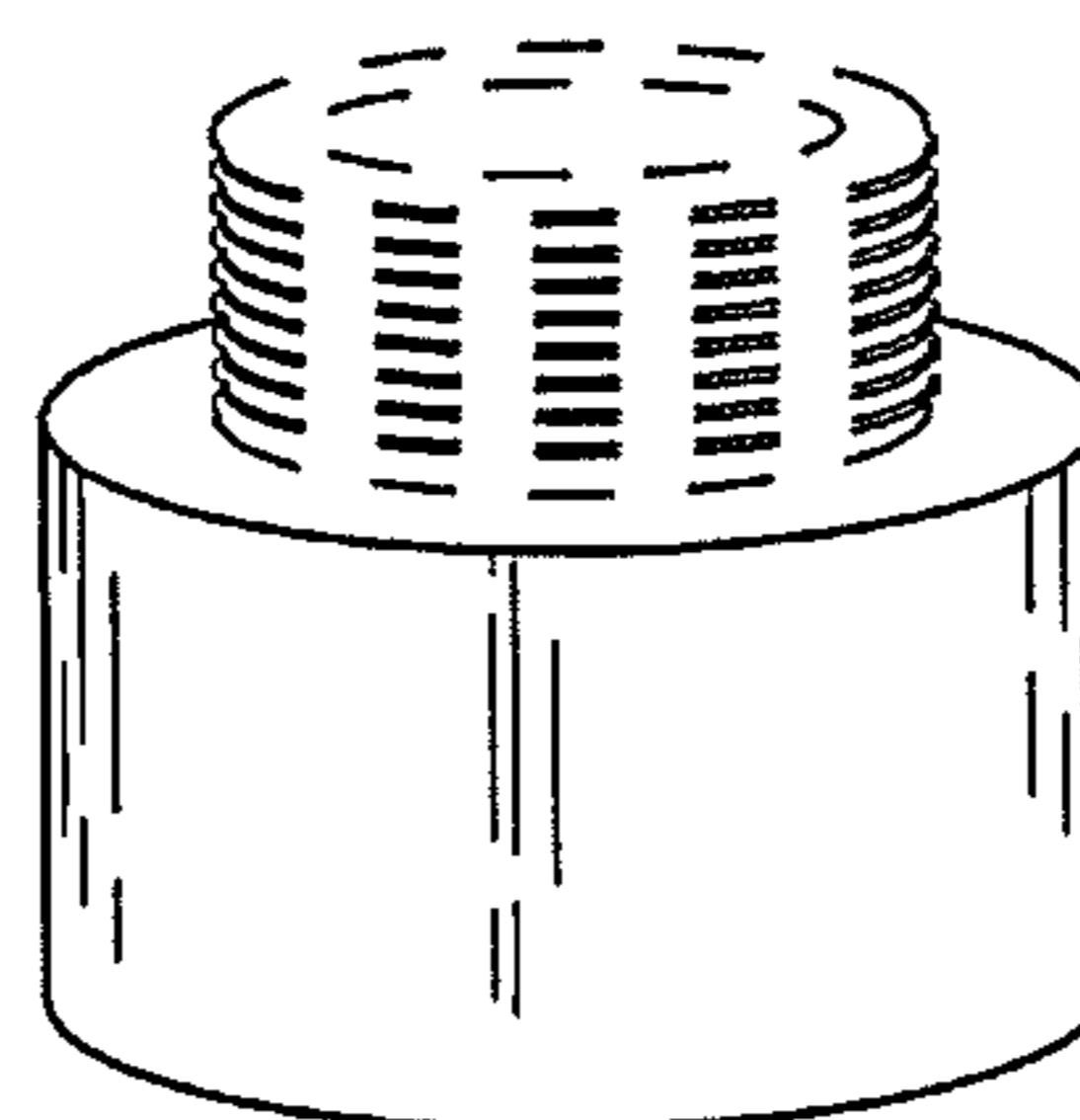

FIG. 14

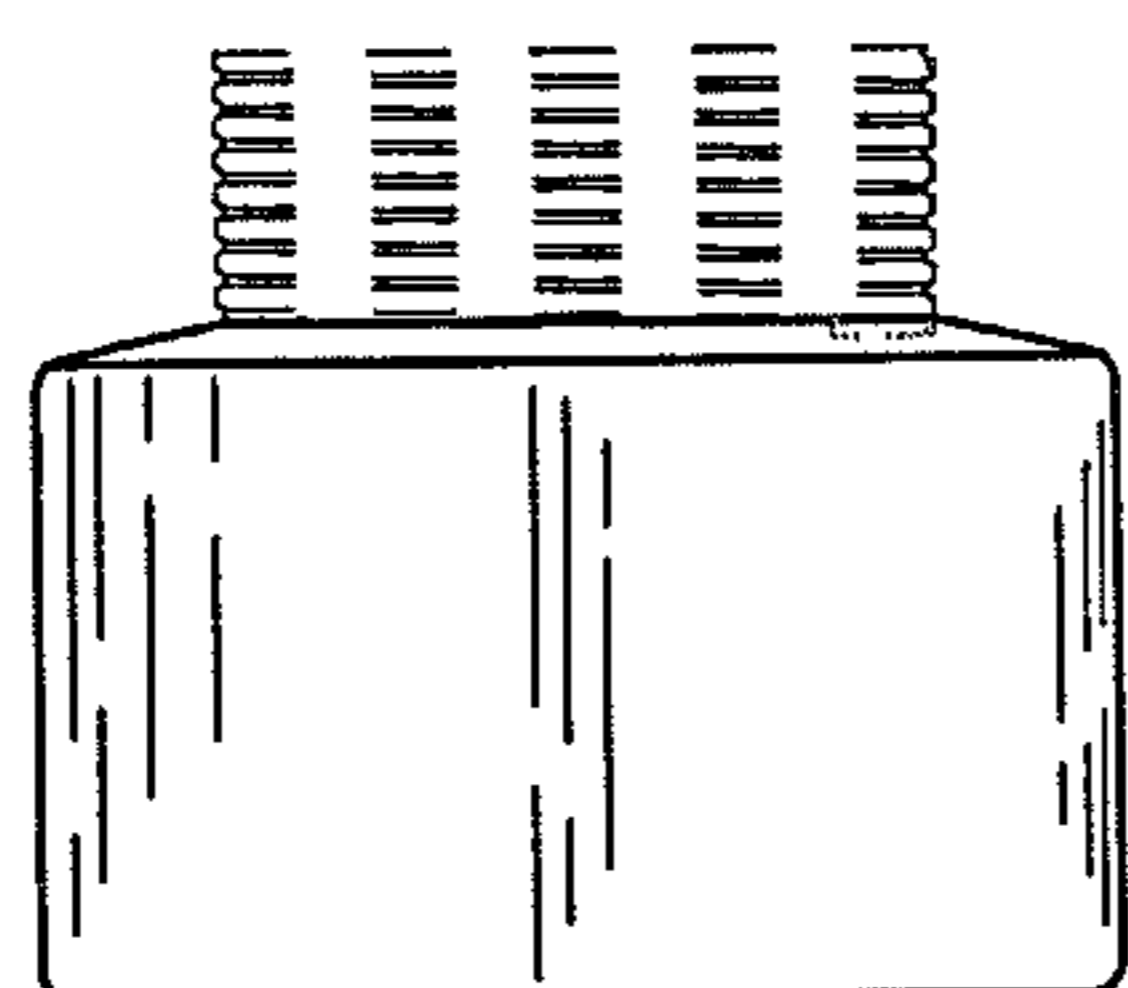

FIG. 10

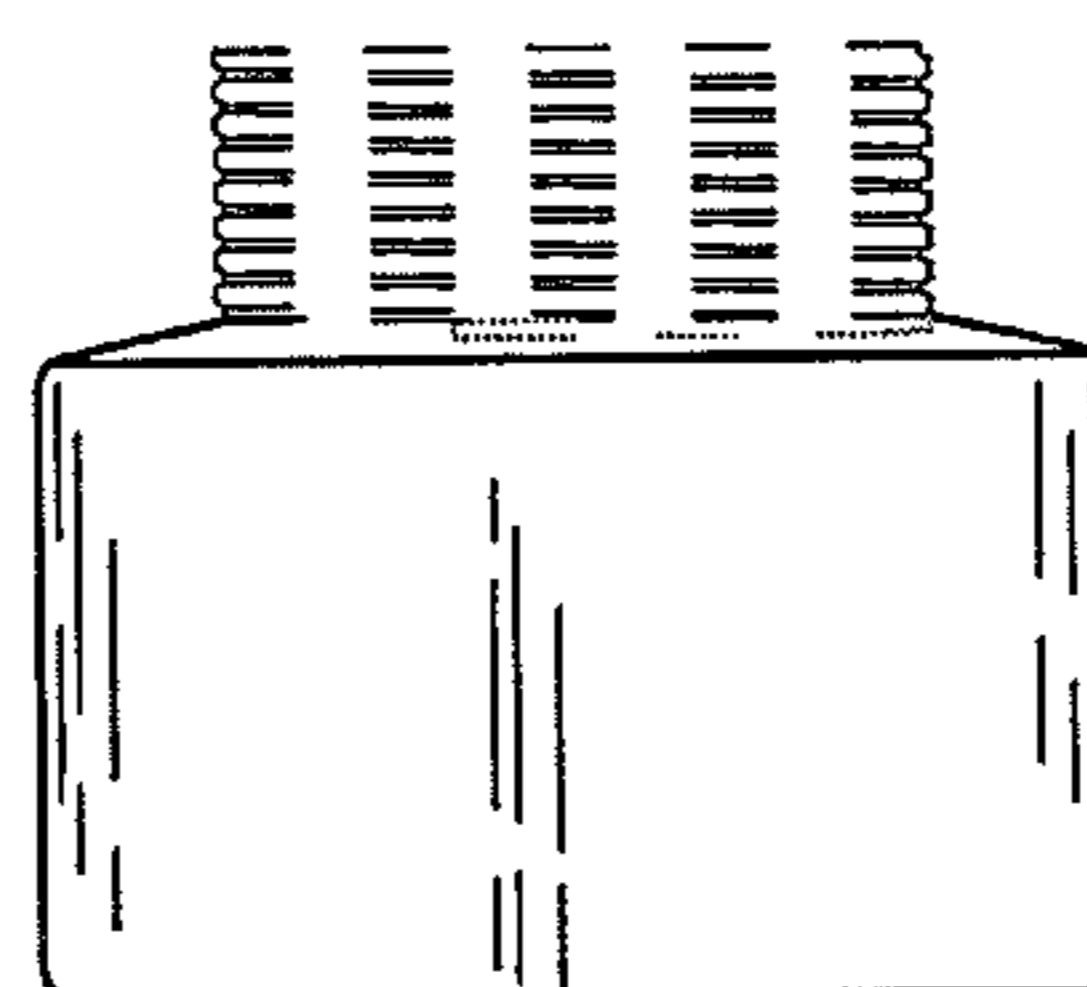

FIG. 11

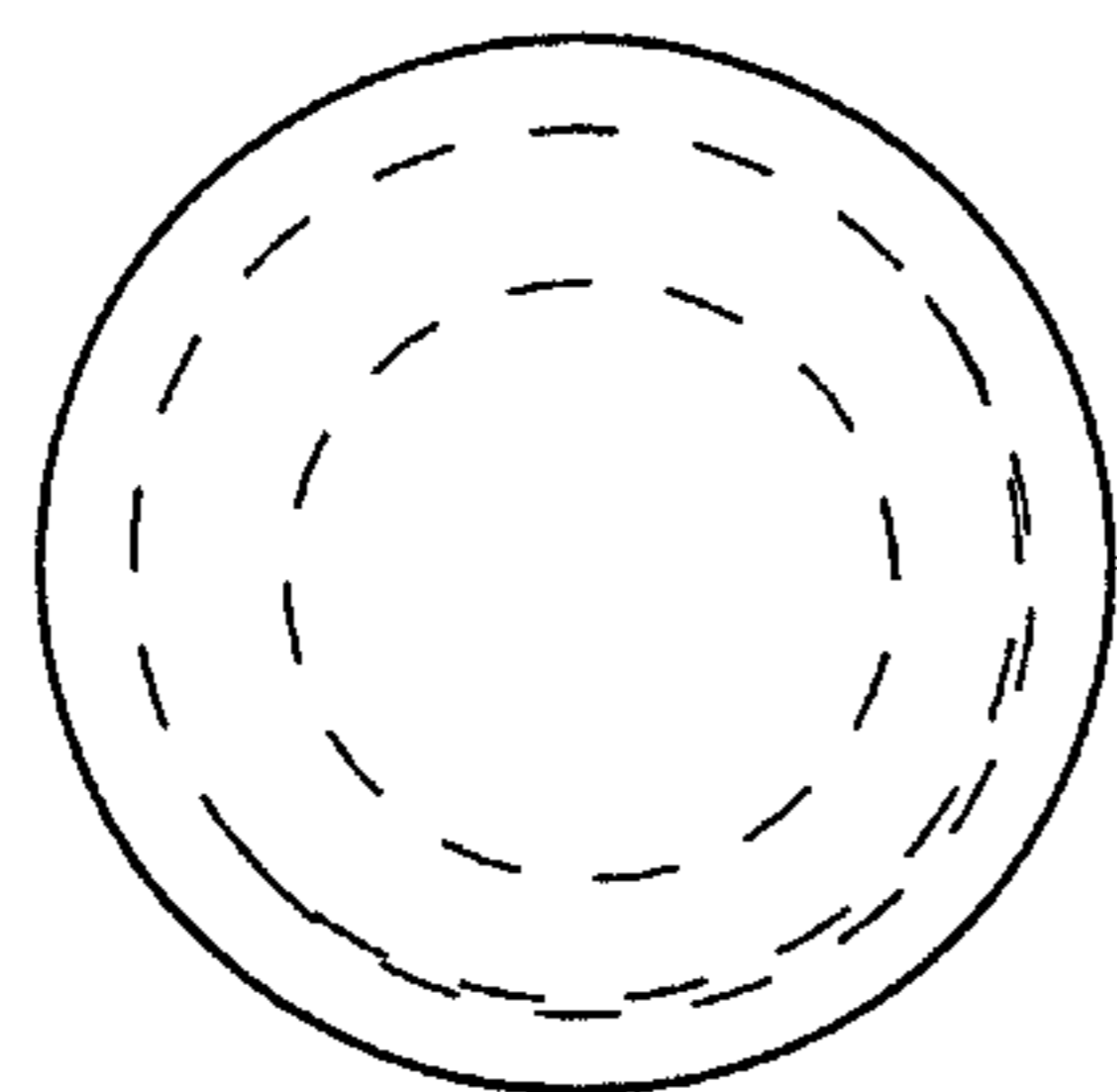

FIG. 13



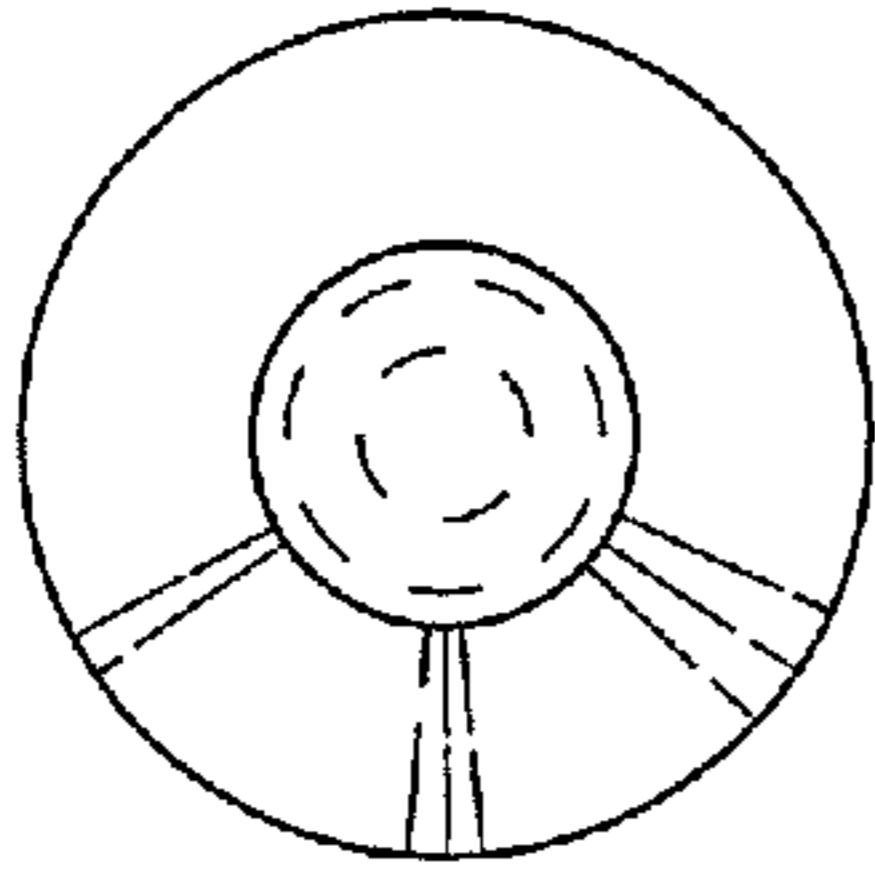

FIG. 17

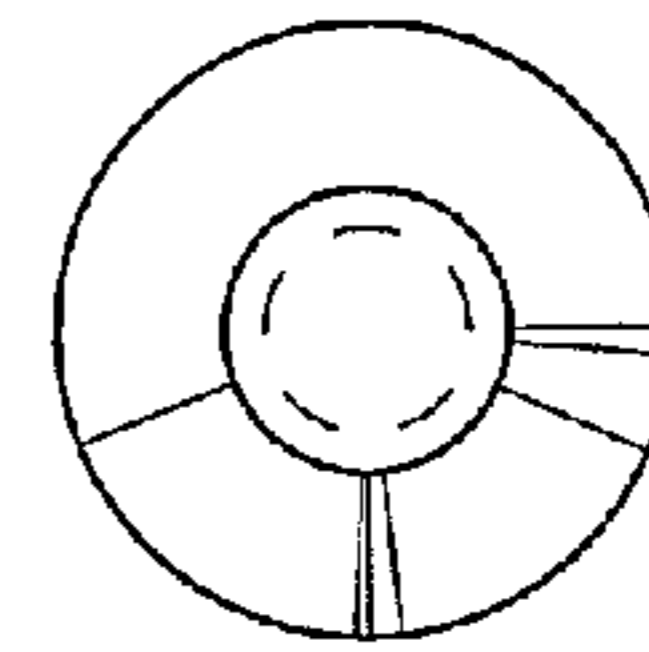

FIG. 21

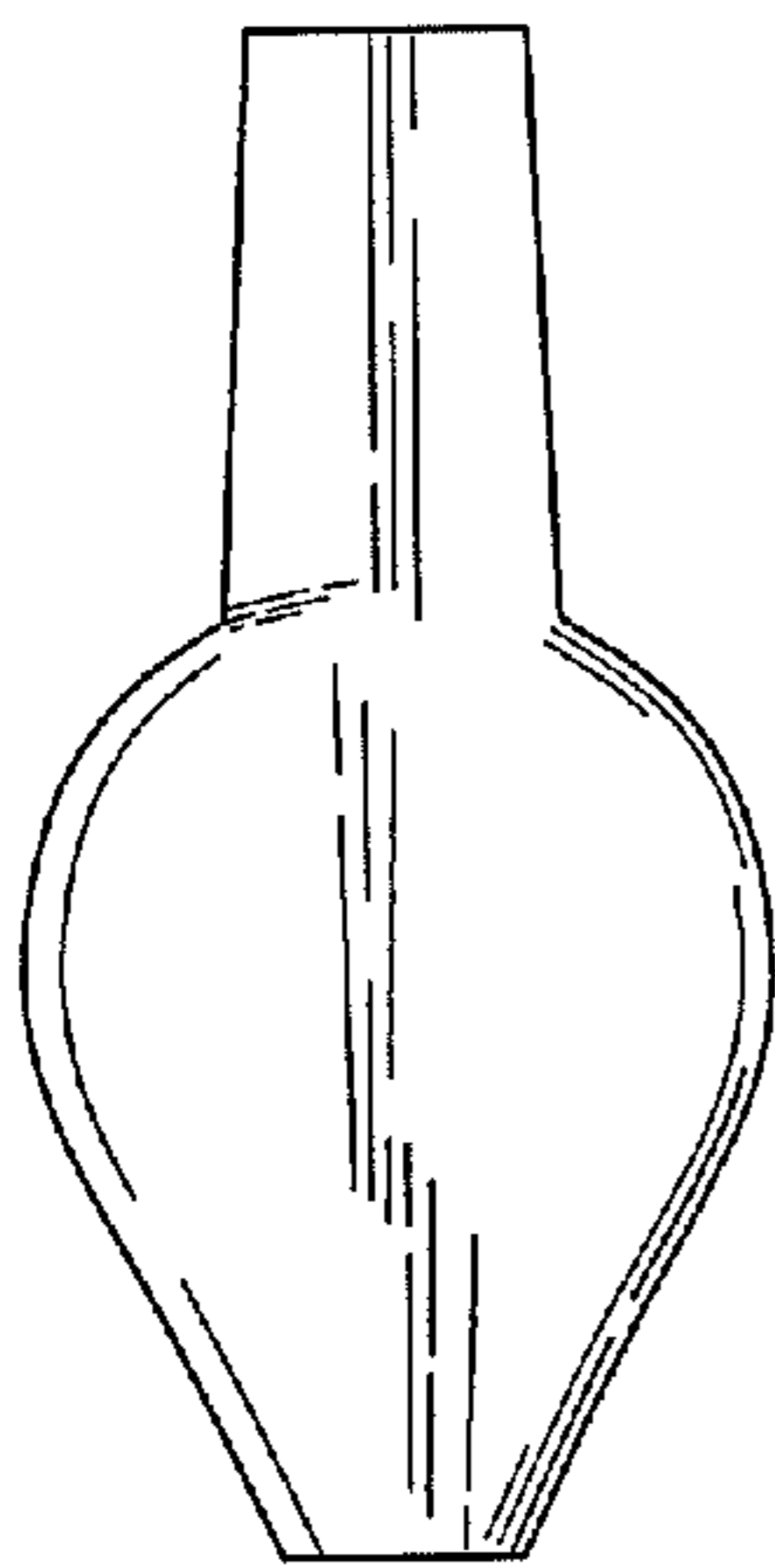

FIG. 15

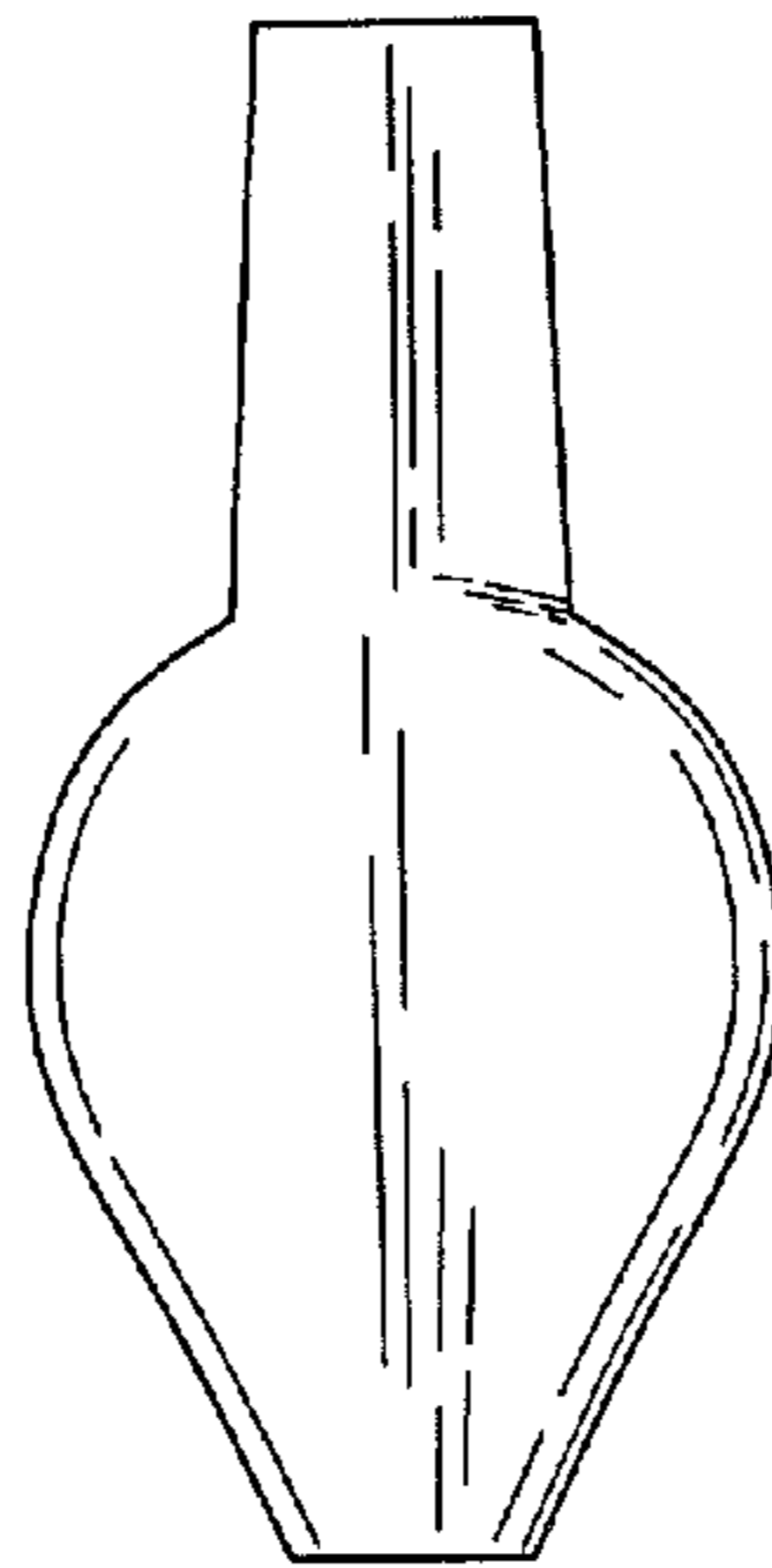

FIG. 16

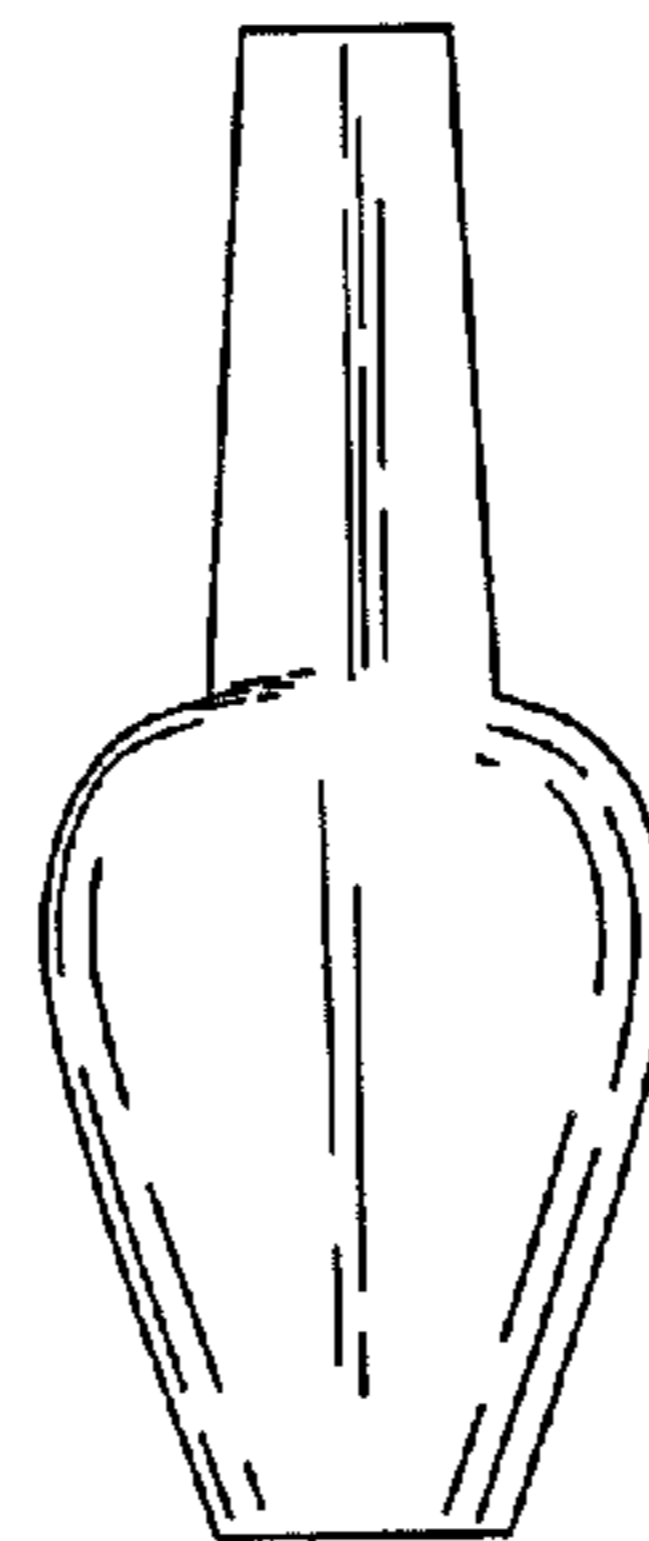

FIG. 19

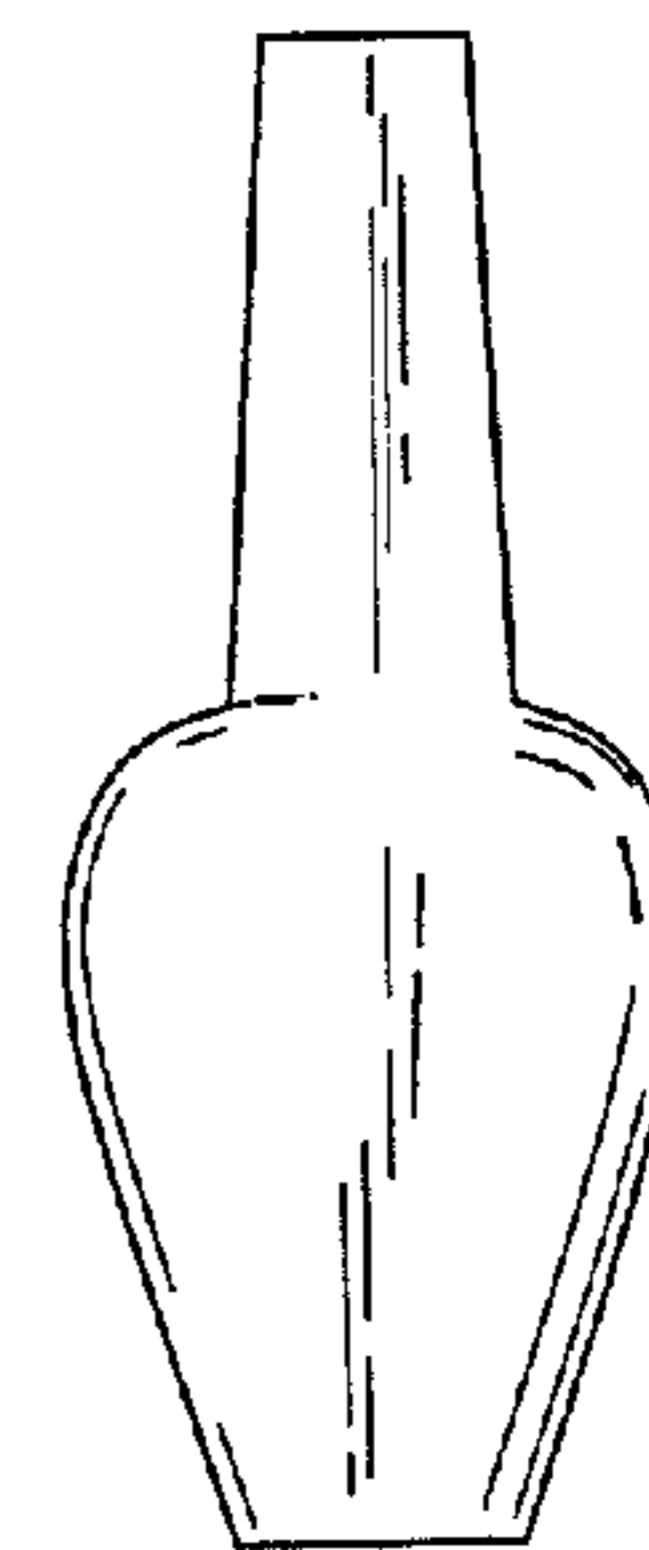

FIG. 20

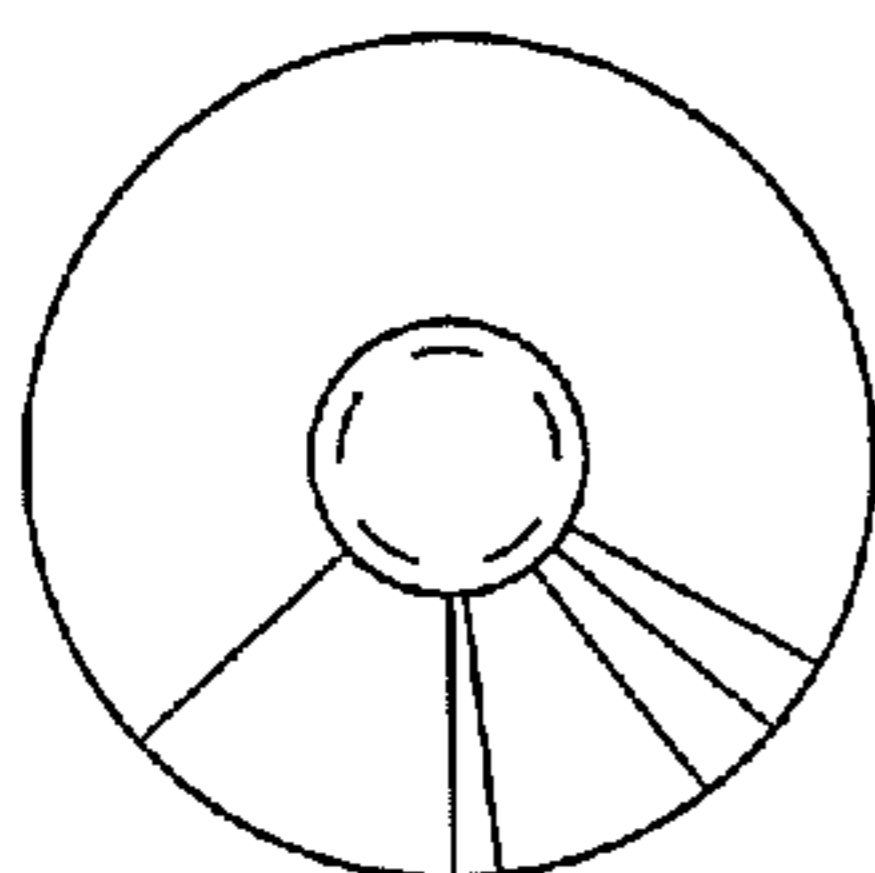

FIG. 18

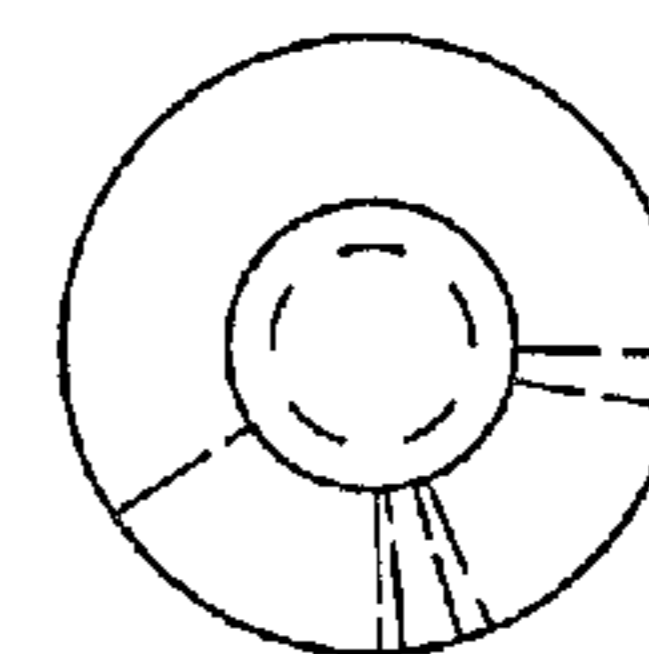

FIG. 22