

US00D731479S

(12) **United States Design Patent**
Lee et al.

(10) **Patent No.:** **US D731,479 S**
(45) **Date of Patent:** **** Jun. 9, 2015**

(54) **PORTABLE TERMINAL**

(71) Applicant: **Samsung Electronics Co., Ltd.**,
Suwon-si (KR)

(72) Inventors: **Ye-Rang Lee**, Gunpo-si (KR); **Yun-Jin Kim**, Seoul (KR)

(73) Assignee: **Samsung Electronics Co., Ltd.**,
Suwon-si (KR)

(**) Term: **14 Years**

(21) Appl. No.: **29/464,578**

(22) Filed: **Aug. 19, 2013**

(30) **Foreign Application Priority Data**

Feb. 18, 2013 (KR) 30-2013-0008363

(51) **LOC (10) Cl.** **14-02**

(52) **U.S. Cl.**
USPC **D14/341**; D14/138 G

(58) **Field of Classification Search**
USPC D14/315-318, 341-347, 420, 426, 429,
D14/129, 130, 496, 137, 138 R, 138 AA,
D14/138 C, 138 G, 147, 203.1, 203.3, 203.4,
D14/203.7, 218, 247, 248, 388, 389, 250;
D10/50, 65, 104.1; D18/6-9, 11;
D21/324, 329, 330, 332; 455/556.1,
455/556.2, 575.1, 90.3; 379/433.01,
379/433.04, 433.06, 916; 345/173, 901,
345/905; 361/679.26, 679.27, 679.3,
361/679.55, 679.56

See application file for complete search history.

(56) **References Cited**

U.S. PATENT DOCUMENTS

D580,900 S * 11/2008 Wong et al. D14/138 AA
D637,992 S * 5/2011 Tom et al. D14/138 G
D652,815 S * 1/2012 Wong D14/138 G
D654,488 S * 2/2012 Chang et al. D14/250

D657,336 S * 4/2012 Nilsen et al. D14/138 G
D669,055 S * 10/2012 Chiu D14/218
D669,892 S * 10/2012 Hofer et al. D14/341
D673,924 S * 1/2013 Mitchell et al. D14/138 G
D681,579 S * 5/2013 Tom et al. D14/138 G
D682,245 S * 5/2013 Harmon et al. D14/138 G
D685,338 S * 7/2013 Park et al. D14/138 G
D688,221 S * 8/2013 Zuffo et al. D14/138 G
D704,685 S * 5/2014 Yeh et al. D14/248
D705,747 S * 5/2014 Boucquey et al. D14/138 G
D710,814 S * 8/2014 Im D14/138 G
D715,245 S * 10/2014 Meneses et al. D14/138 G
D719,145 S * 12/2014 Barfoot et al. D14/250
D721,051 S * 1/2015 Lee et al. D14/138 G

* cited by examiner

Primary Examiner — Barbara Fox

Assistant Examiner — Dana K Weiland

(74) *Attorney, Agent, or Firm* — NSIP Law

(57) **CLAIM**

The ornamental design for a portable terminal, as shown and described.

DESCRIPTION

FIG. 1 is a front perspective view of a portable terminal showing our new design;
FIG. 2 is a front view thereof;
FIG. 3 is a rear view thereof;
FIG. 4 is a left-side view thereof;
FIG. 5 is a right-side view thereof;
FIG. 6 is a top view thereof;
FIG. 7 is a bottom view thereof;
FIG. 8 is a rear perspective view thereof; and,
FIG. 9 is an enlarged view of the encircled portion A as shown in FIG. 2.

The broken lines shown in the drawings represent portions of the portable terminal that form no part of the claimed design. The dot-dash broken lines encircling portions of the claimed design that are illustrated in enlargements for no part of the claimed design. The shade lines in the figures show contour and not surface ornamentation.

1 Claim, 7 Drawing Sheets

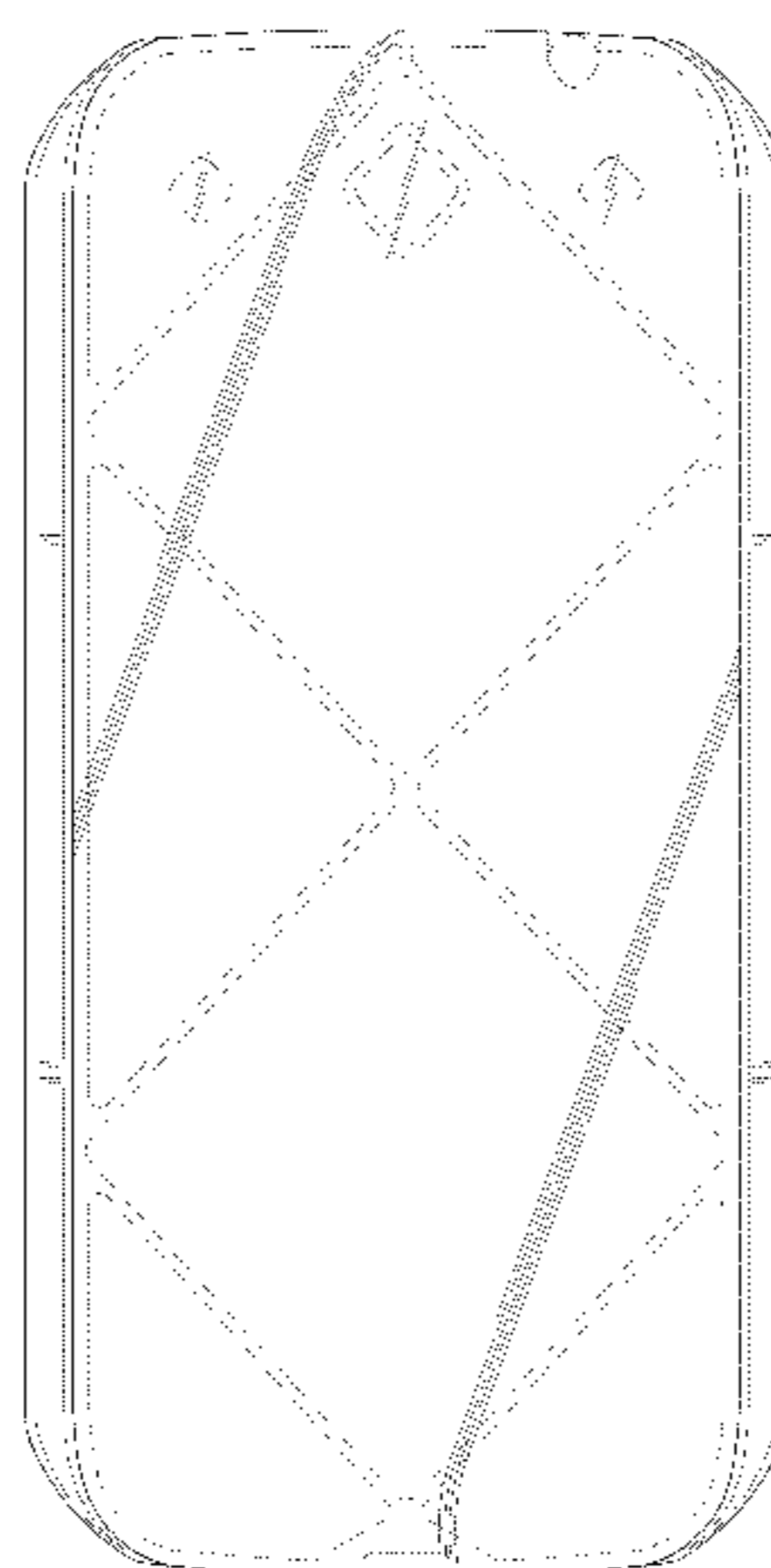
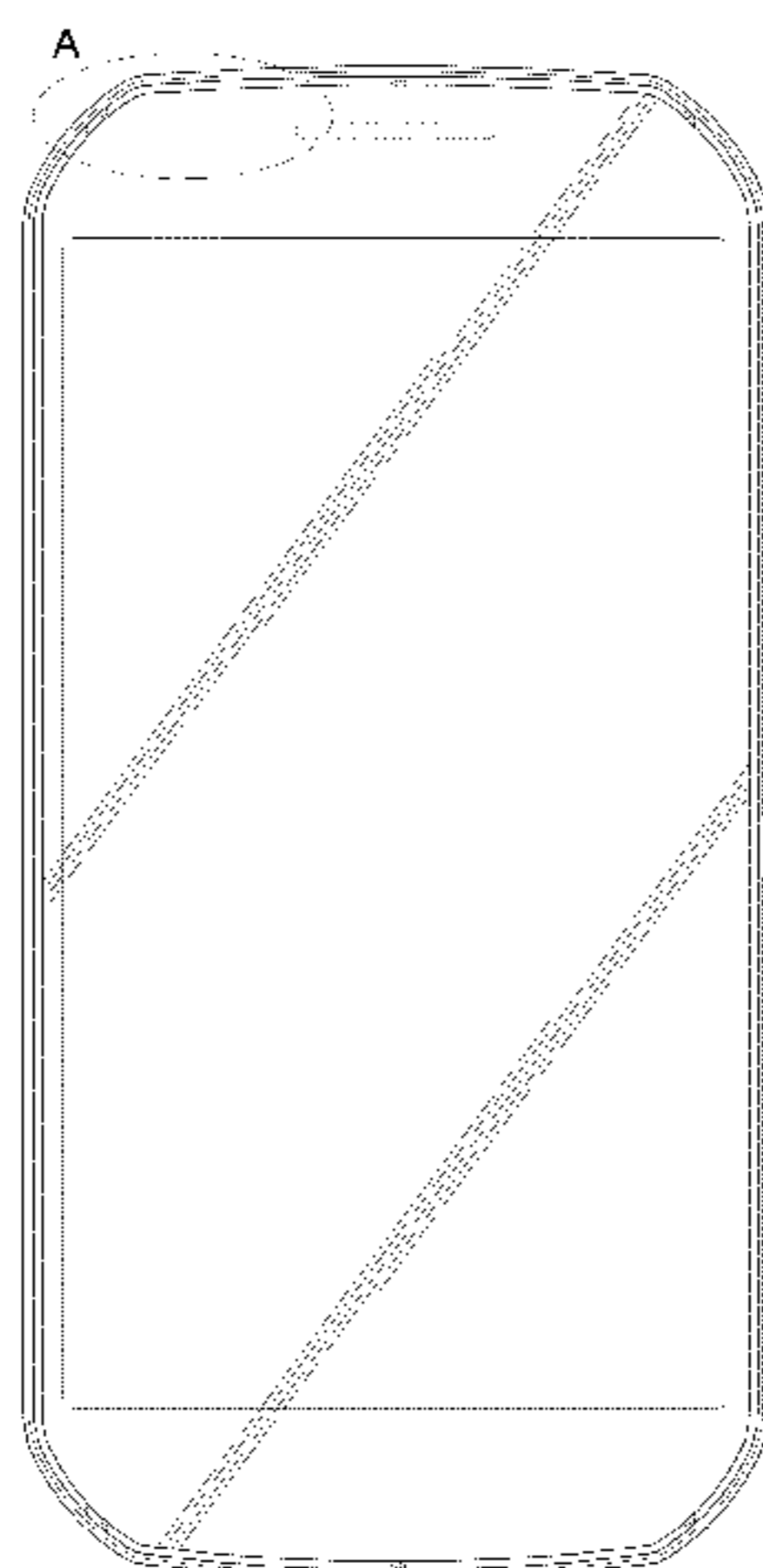

FIG.1

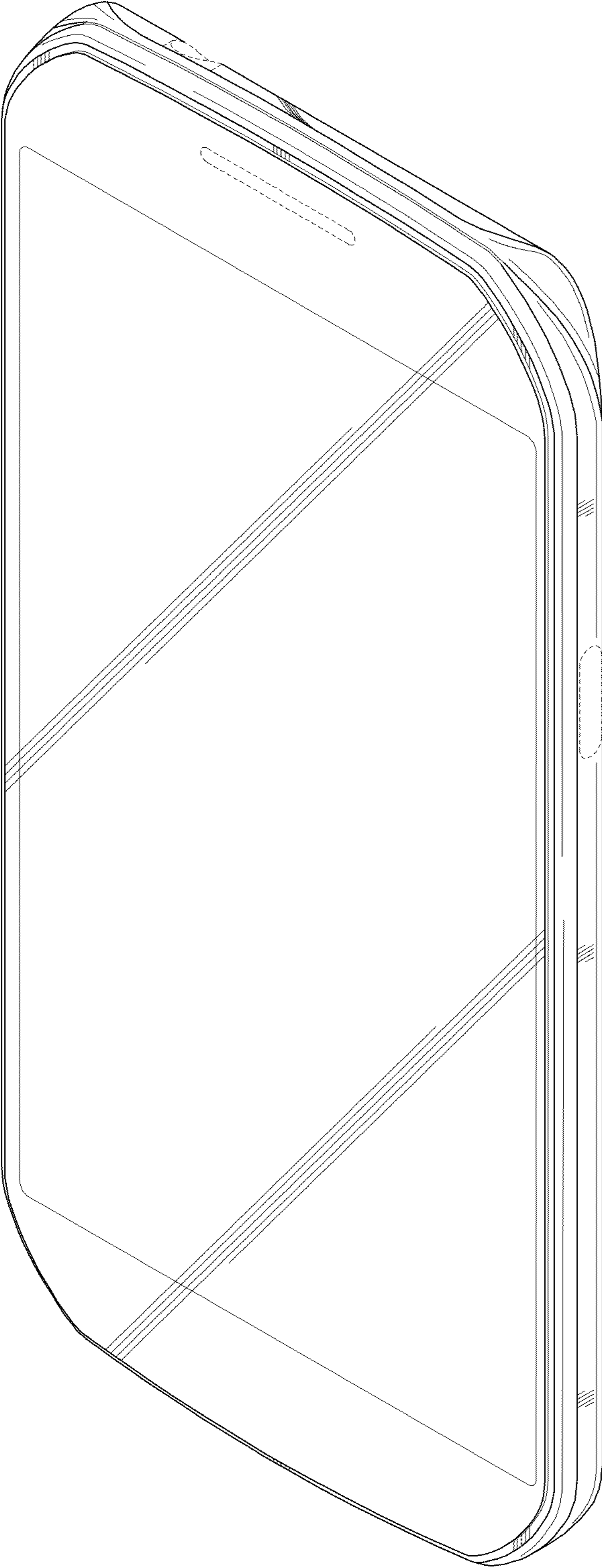

FIG.2

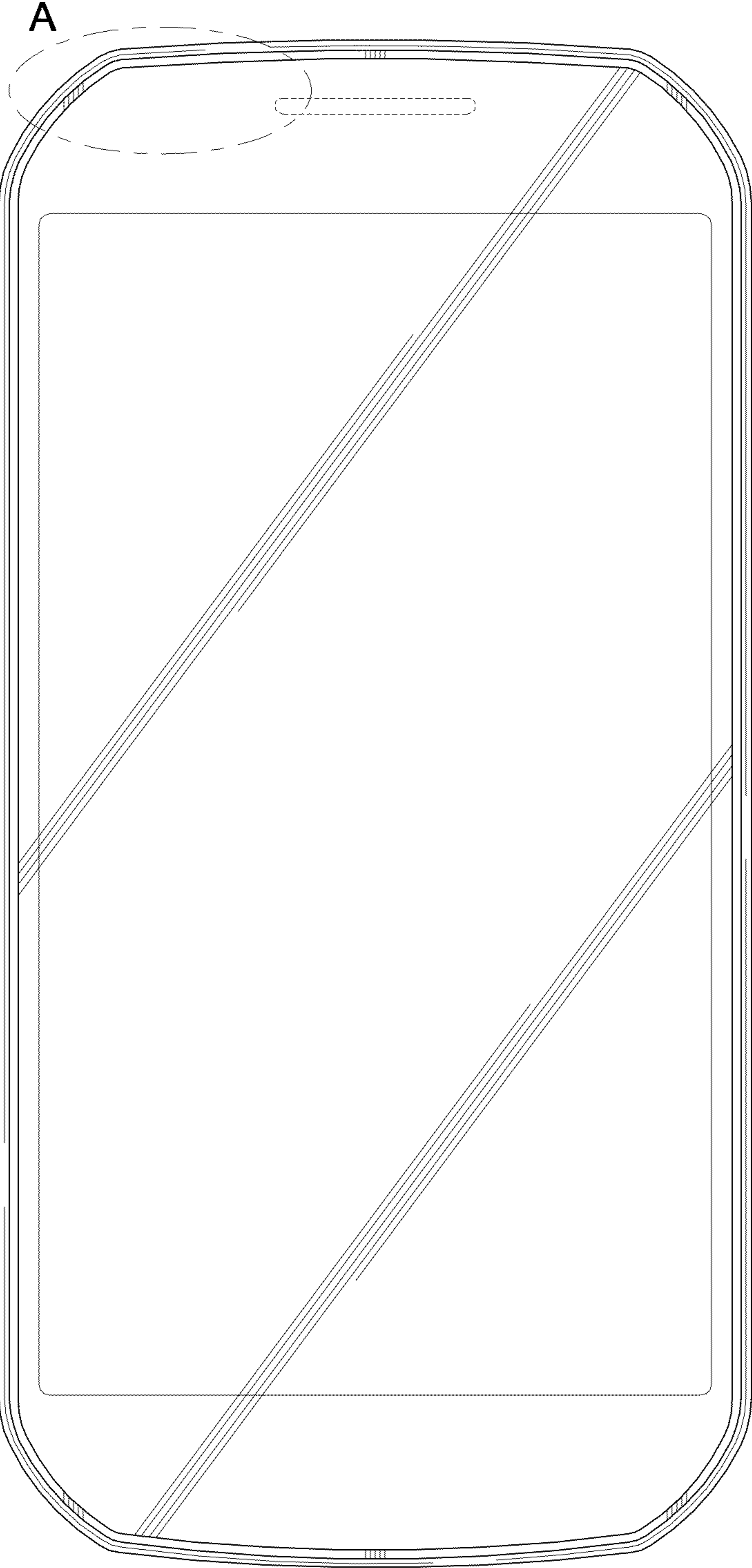

FIG.3

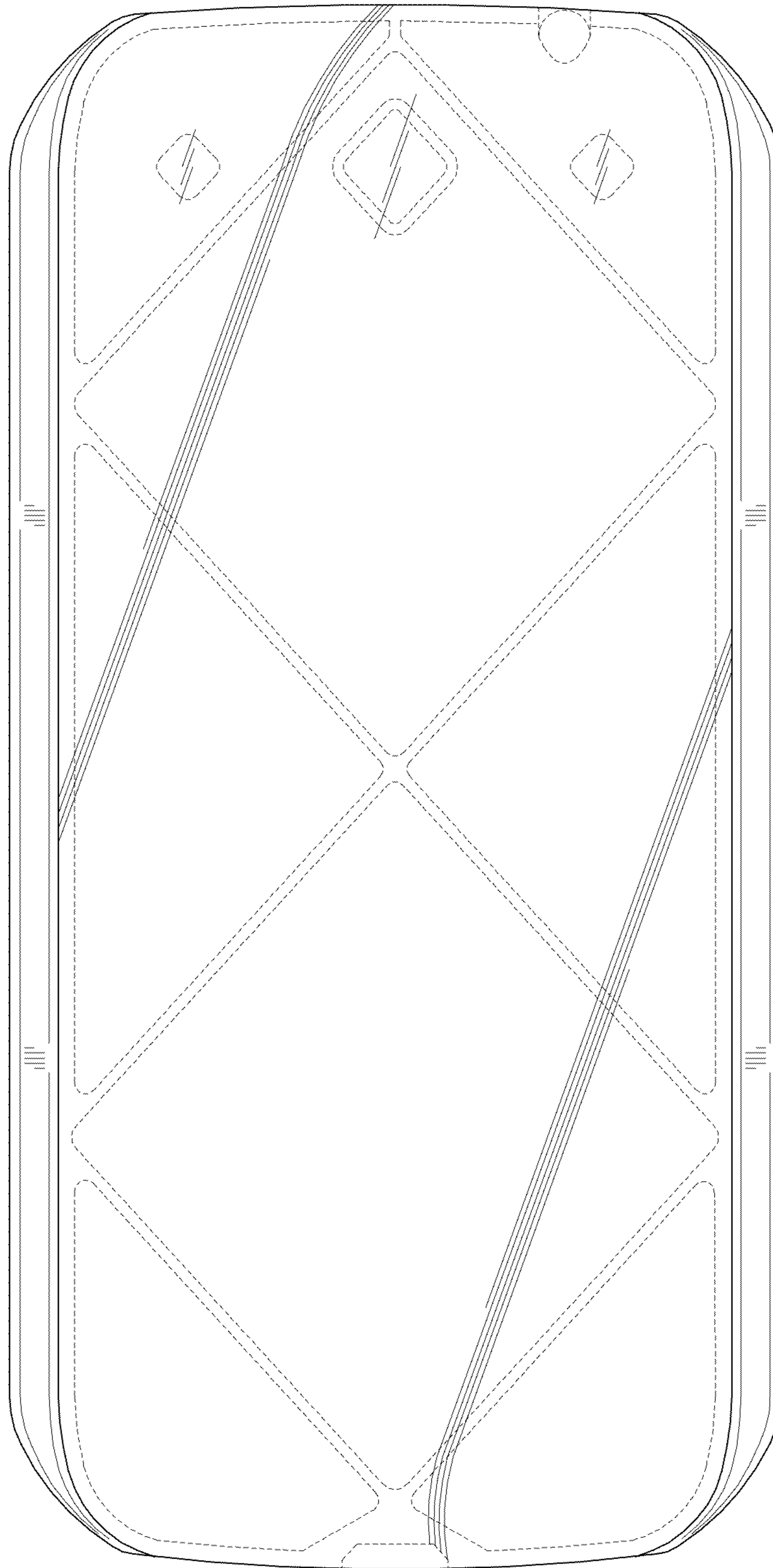

FIG.4

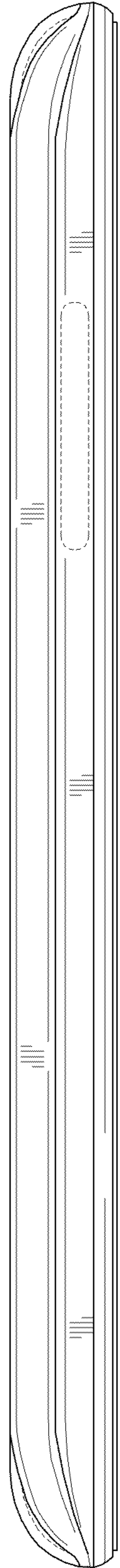

FIG.5

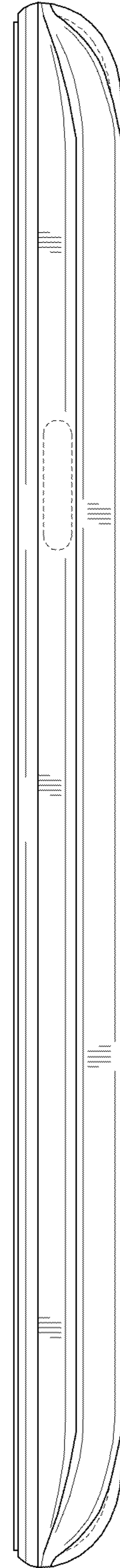

FIG.6

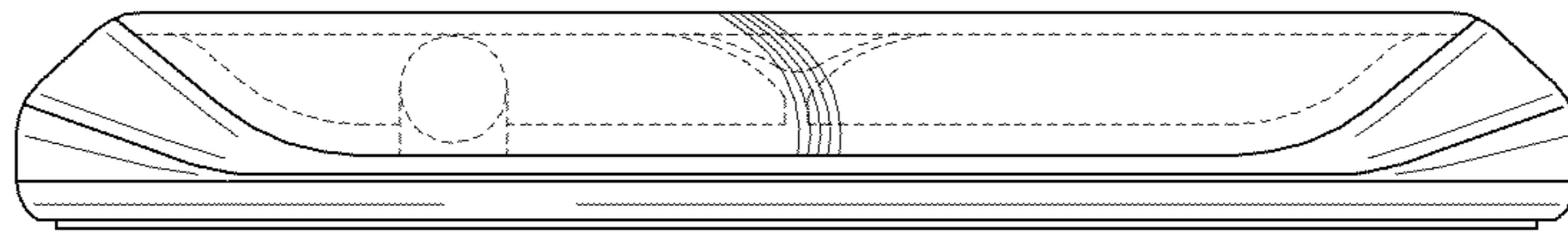

FIG.7

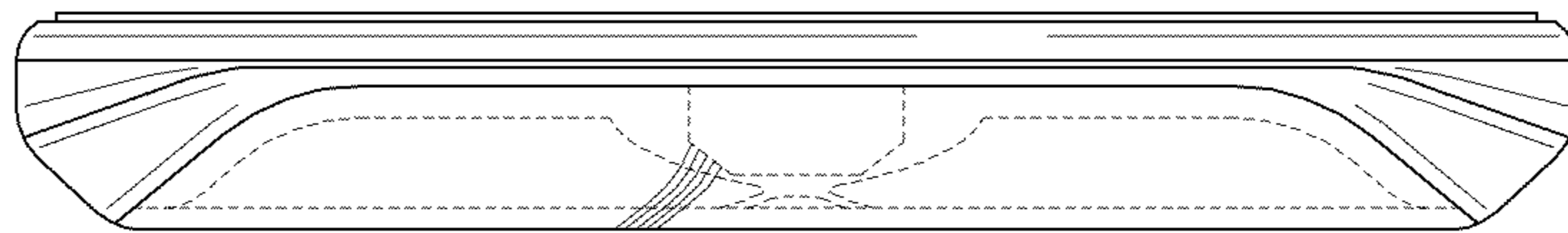

FIG.8

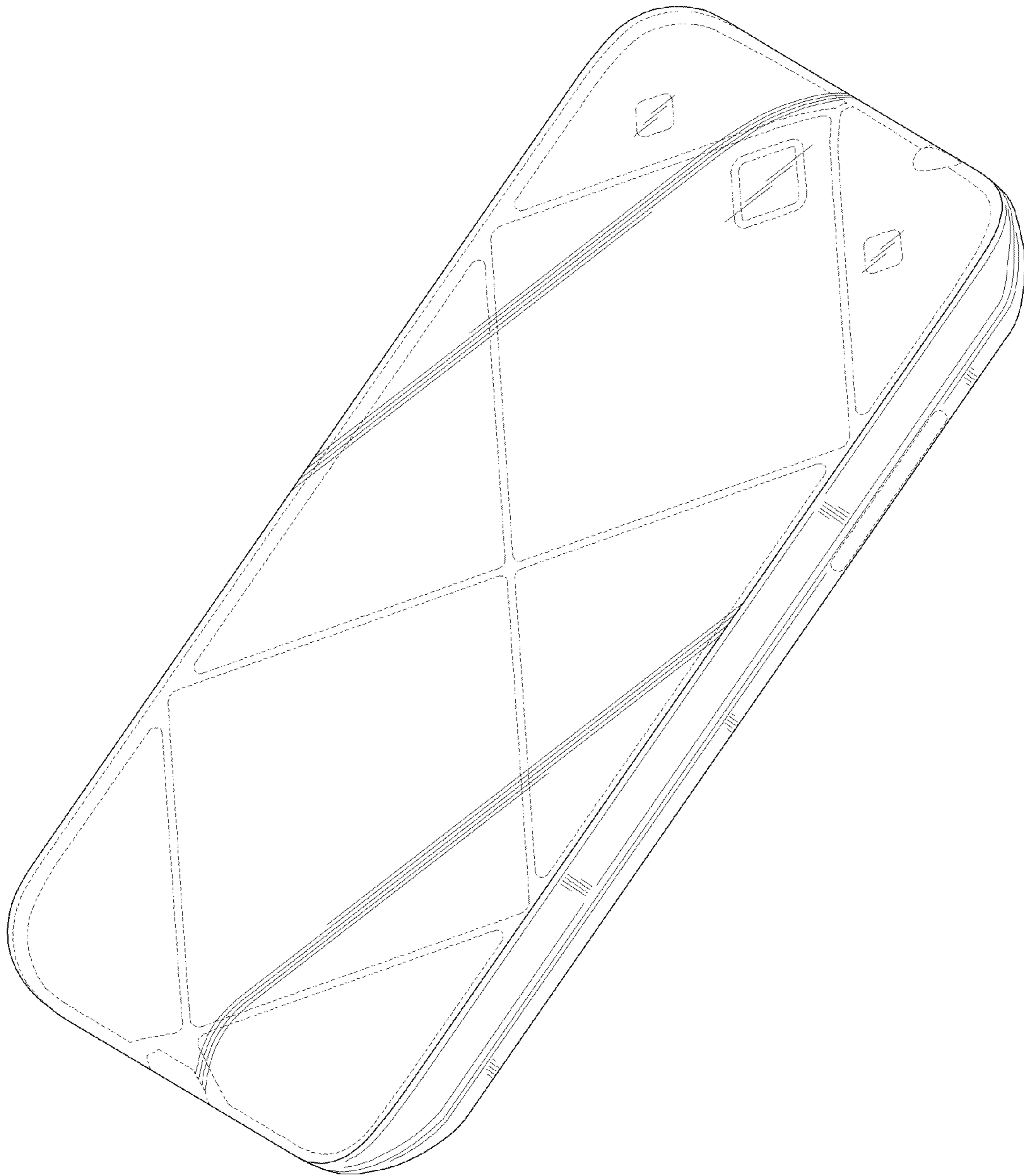

FIG.9

