



US00D731456S

(12) **United States Design Patent**  
**Dahlberg**

(10) **Patent No.:** **US D731,456 S**  
(45) **Date of Patent:** **\*\* Jun. 9, 2015**

- (54) **CONTROL UNIT FOR EARPIECE**
- (71) Applicant: **Sony Mobile Communications AB,**  
Lund (SE)
- (72) Inventor: **Staffan Dahlberg,** Lund (SE)
- (73) Assignee: **Sony Mobile Communications AB,**  
Lund (SE)
- (\*\*) Term: **14 Years**
- (21) Appl. No.: **29/483,766**
- (22) Filed: **Mar. 3, 2014**
- (30) **Foreign Application Priority Data**  
Nov. 18, 2013 (EM) ..... 002347237
- (51) **LOC (10) Cl.** ..... **14-01**
- (52) **U.S. Cl.**  
USPC ..... **D14/205**
- (58) **Field of Classification Search**  
USPC ..... D14/205, 223, 218, 188, 155, 240;  
D21/566; 379/420.04; 381/370, 372,  
381/374, 384; 361/832; 455/575.6;  
D13/168  
CPC ..... H04R 25/00  
See application file for complete search history.

D539,782 S *	4/2007	Lee .....	D14/188
D578,508 S *	10/2008	Wang .....	D14/206
D589,028 S *	3/2009	Haapapuro et al. ....	D14/206
D593,999 S *	6/2009	Mauritzsson .....	D14/225
D603,378 S *	11/2009	Paradise .....	D14/223
D613,274 S *	4/2010	Lee et al. ....	D14/225
D625,294 S *	10/2010	Wada .....	D14/218
D681,015 S *	4/2013	Akana et al.	
D685,750 S *	7/2013	Nakagawa .....	D13/168
D698,750 S *	2/2014	Yoon .....	D14/206
D712,371 S *	9/2014	Henning .....	D14/205
D716,758 S *	11/2014	Burgett et al. ....	D14/205
D717,274 S *	11/2014	Burgett et al. ....	D14/205
D717,275 S *	11/2014	Burgett et al. ....	D14/205
D718,273 S *	11/2014	Harata et al. ....	D14/205
2013/0077815 A1 *	3/2013	Stephenson .....	381/370

**FOREIGN PATENT DOCUMENTS**

EM	002199117-0001	3/2013
EM	002199117-0002	3/2013

(Continued)

*Primary Examiner* — Paula Greene

(74) *Attorney, Agent, or Firm* — Renner, Otto, Boisselle & Sklar, LLP

(57) **CLAIM**

The ornamental design for a control unit for earpiece, as shown and described.

**DESCRIPTION**

FIG. 1 is a perspective view a control unit for earpiece showing my new design.

FIG. 2 is another perspective view thereof.

FIG. 3 is a front view thereof.

FIG. 4 is left side view thereof, a right side view being a mirror image of the left side view.

FIG. 5 is rear view thereof.

FIG. 6 is a bottom view thereof; and,

FIG. 7 is a top view thereof.

The broken lines form no part of the claimed design.

**1 Claim, 3 Drawing Sheets**

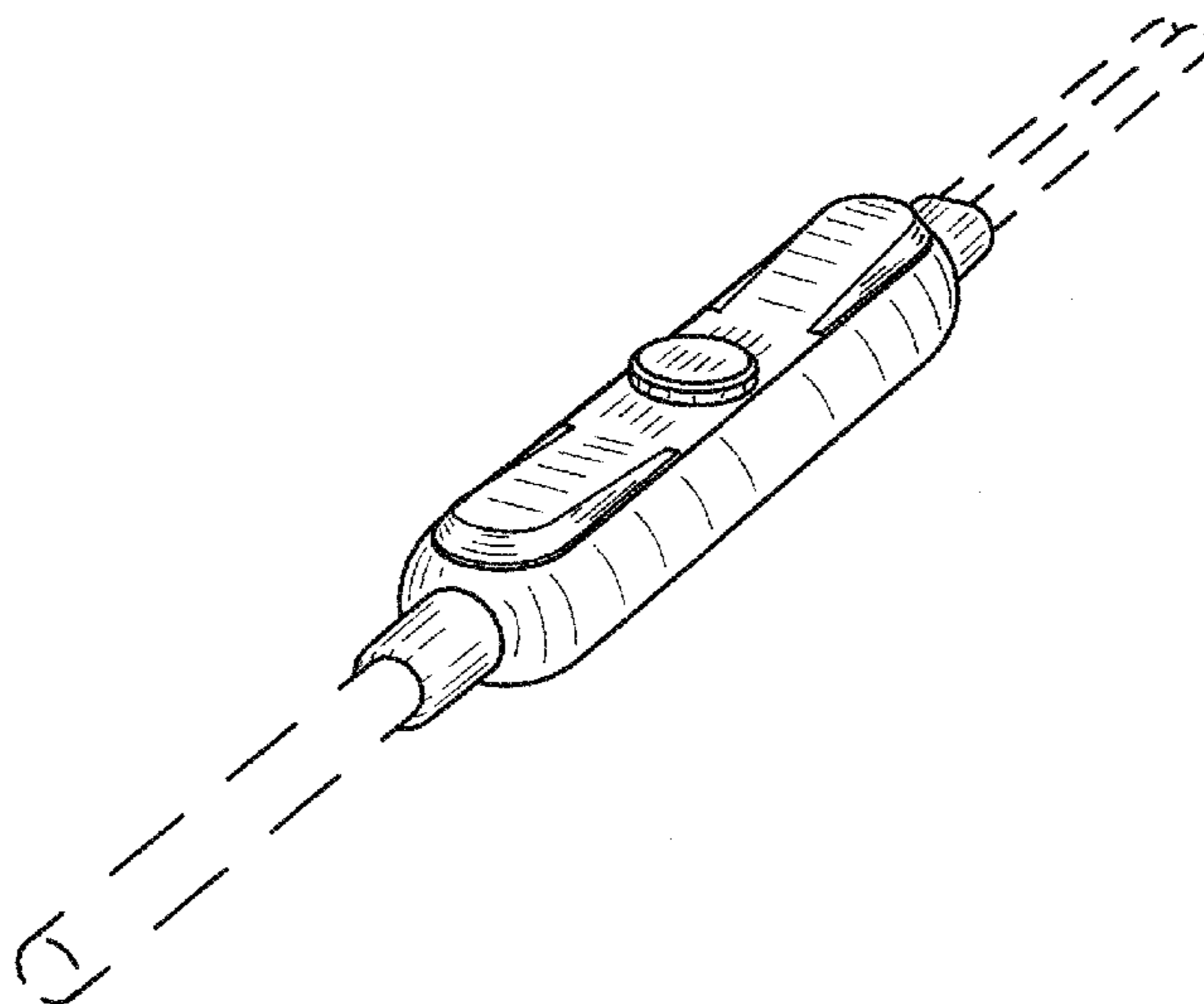

(56)

**References Cited**

FOREIGN PATENT DOCUMENTS

EM	002199117-0005	3/2013
EM	002199117-0006	3/2013
JP	D1481546 S	10/2013

EM	002199117-0003	3/2013
EM	002199117-0004	3/2013

\* cited by examiner

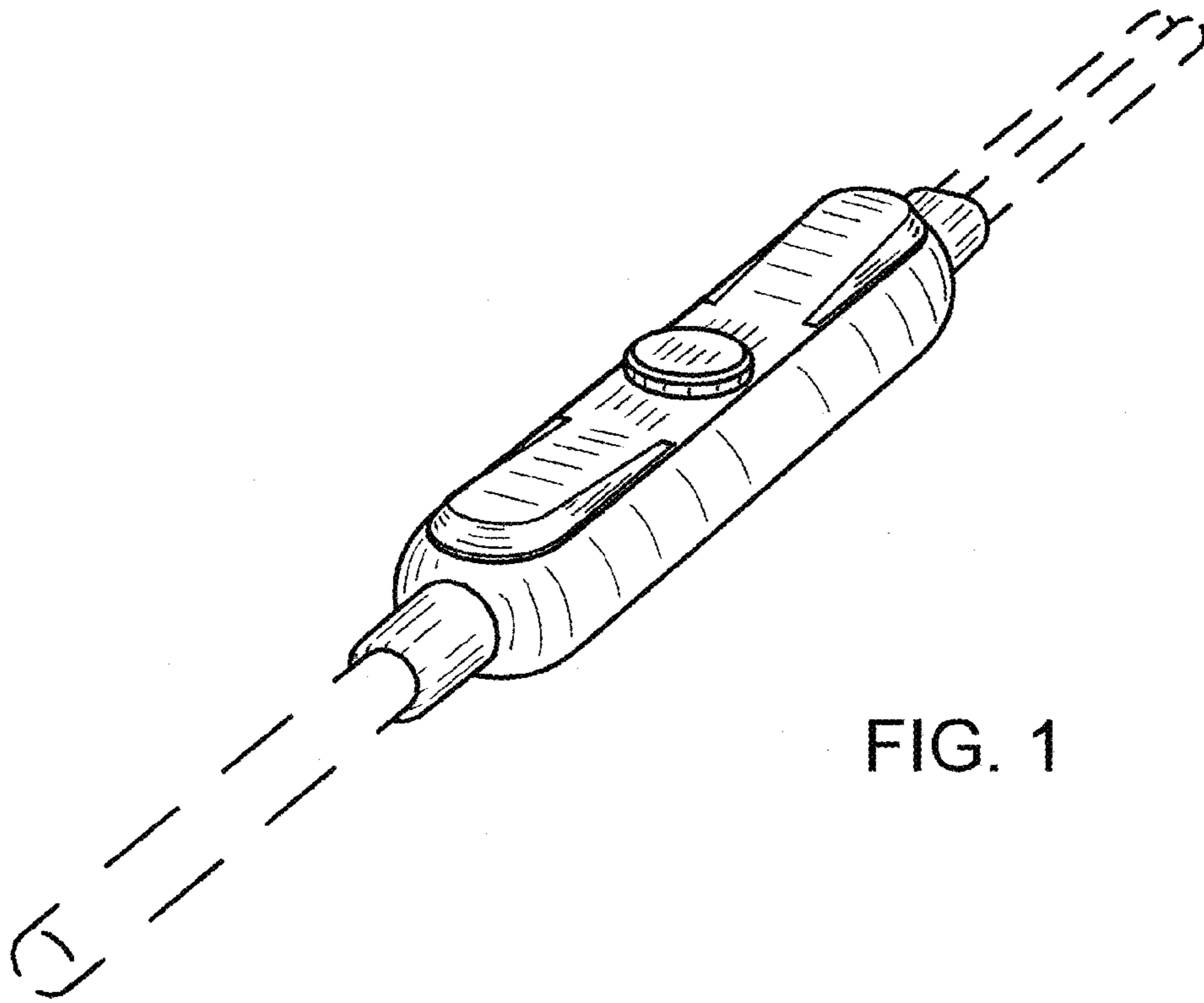

FIG. 1

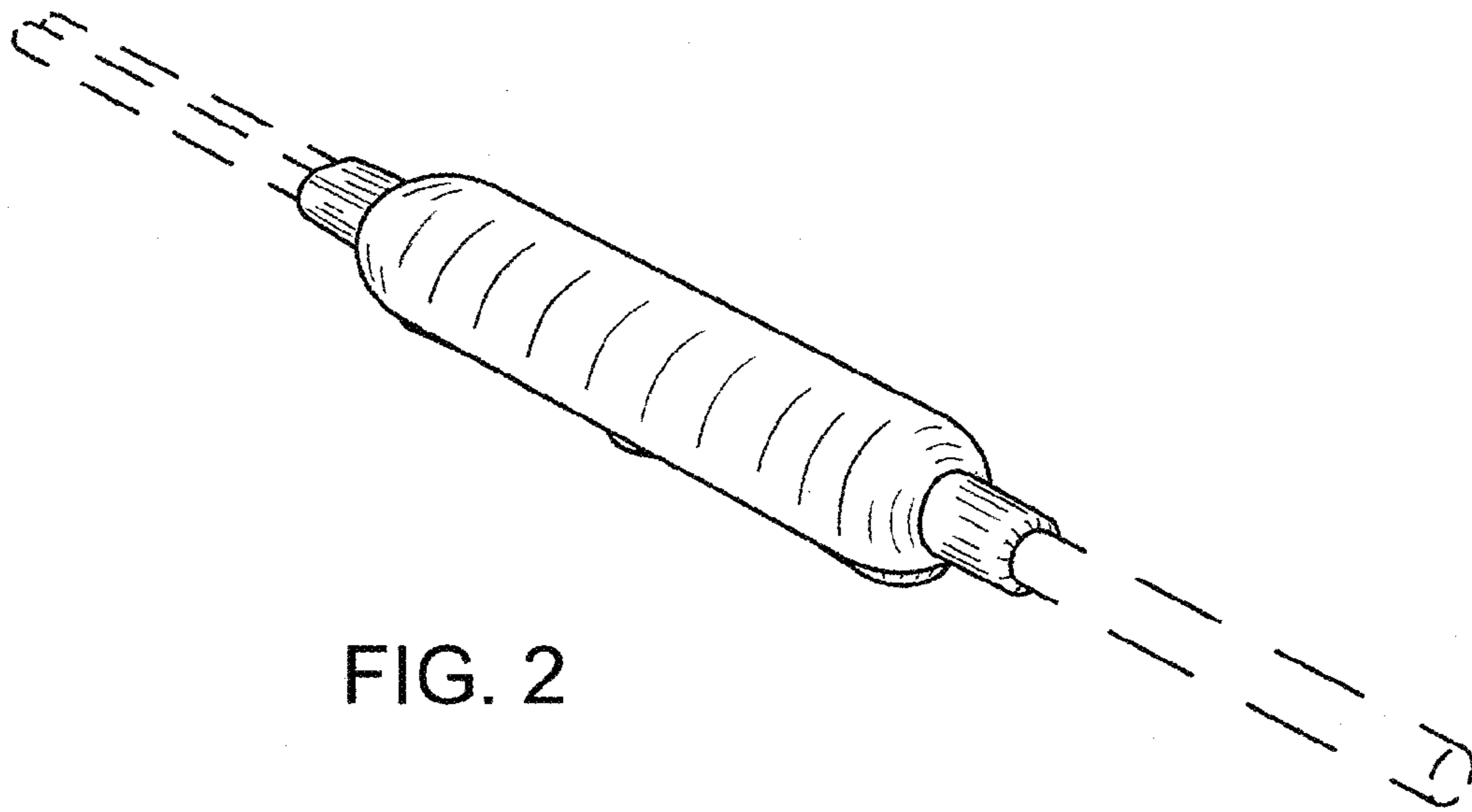

FIG. 2

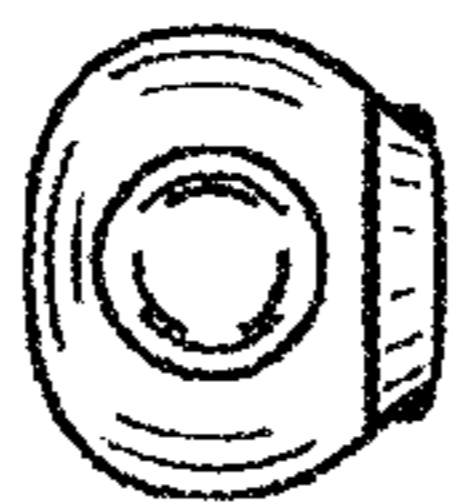

FIG. 6

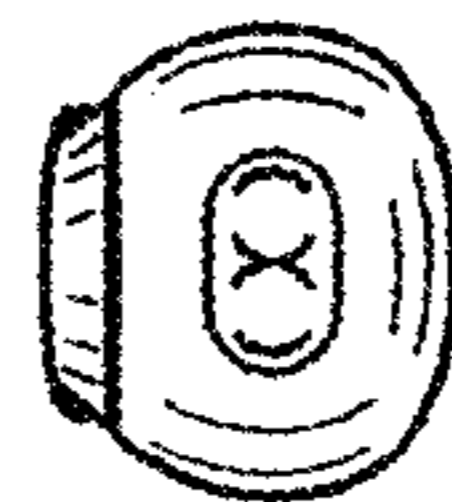

FIG. 7

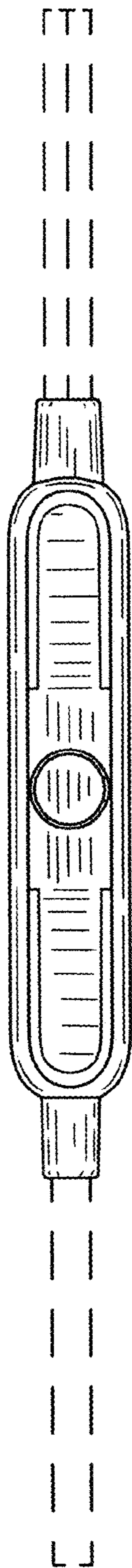

FIG. 3

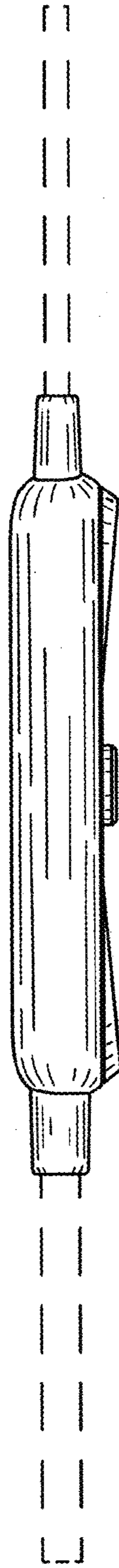

FIG. 4

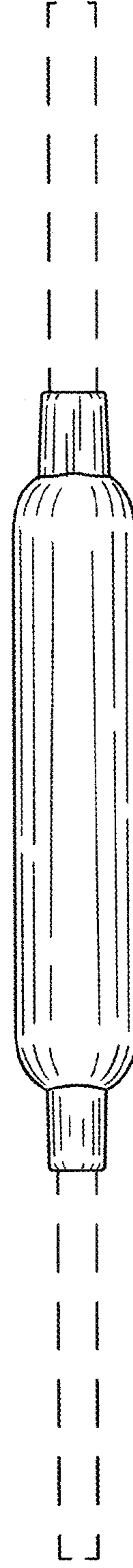

FIG. 5