



US00D731365S

(12) **United States Design Patent**
Arai et al.

(10) **Patent No.:** **US D731,365 S**
(45) **Date of Patent:** **** Jun. 9, 2015**

(54) **MOTOR SCOOTER**
(71) Applicant: **HONDA MOTOR CO., LTD.**, Tokyo (JP)
(72) Inventors: **Keisuke Arai**, Wako (JP); **Gianfelice Marasco**, Rome (IT)
(73) Assignee: **HONDA MOTOR CO., LTD.**, Tokyo (JP)
(**) Term: **14 Years**

D610,490 S *	2/2010	Wong	D12/110
D622,636 S *	8/2010	Cheng	D12/110
D632,227 S *	2/2011	Lambri	D12/110
D643,782 S *	8/2011	Maccioni	D12/110
D654,402 S *	2/2012	Lambri et al.	D12/110
D662,860 S *	7/2012	Devernay et al.	D12/110
D669,395 S *	10/2012	Lambri et al.	D12/110
D669,396 S *	10/2012	Sawatsutipan et al.	D12/110
D670,206 S *	11/2012	Nitta et al.	D12/110
D678,129 S *	3/2013	Kubota et al.	D12/110
D680,911 S *	4/2013	Wu et al.	D12/110
D688,598 S *	8/2013	Lambri et al.	D12/110
D696,982 S *	1/2014	Nishimoto et al.	D12/110
D697,835 S *	1/2014	Kito et al.	D12/110

(21) Appl. No.: **29/460,109**
(22) Filed: **Jul. 8, 2013**
(30) **Foreign Application Priority Data**
Jan. 9, 2013 (JP) 2013-000163
(51) **LOC (10) Cl.** **12-11**
(52) **U.S. Cl.**
USPC **D12/114**
(58) **Field of Classification Search**
USPC D12/110, 114; 180/219, 220, 225, 229;
296/37.12, 78.1
See application file for complete search history.

* cited by examiner

Primary Examiner — Robert M Spear
Assistant Examiner — Ryan Harvey
(74) *Attorney, Agent, or Firm* — Birch, Stewart, Kolasch & Birch, LLP

(56) **References Cited**
U.S. PATENT DOCUMENTS
D286,521 S * 11/1986 Tanaka et al. D12/110
D341,341 S * 11/1993 Nakamura et al. D12/110
D503,907 S * 4/2005 Beggio

(57) **CLAIM**
The ornamental design for a motor scooter, as shown and described.

DESCRIPTION
FIG. 1 is a front view of a motor scooter showing my new design;
FIG. 2 is a rear view thereof;
FIG. 3 is a plan view thereof;
FIG. 4 is a bottom view thereof;
FIG. 5 is a right side view thereof;
FIG. 6 is a left side view thereof;
FIG. 7 is a right, front perspective view thereof;
FIG. 8 is a left, front perspective view thereof;
FIG. 9 is a right, rear perspective view thereof; and,
FIG. 10 is a left, rear perspective view thereof.
The portions shown in broken lines show environment and form no part of the claimed design.

1 Claim, 10 Drawing Sheets

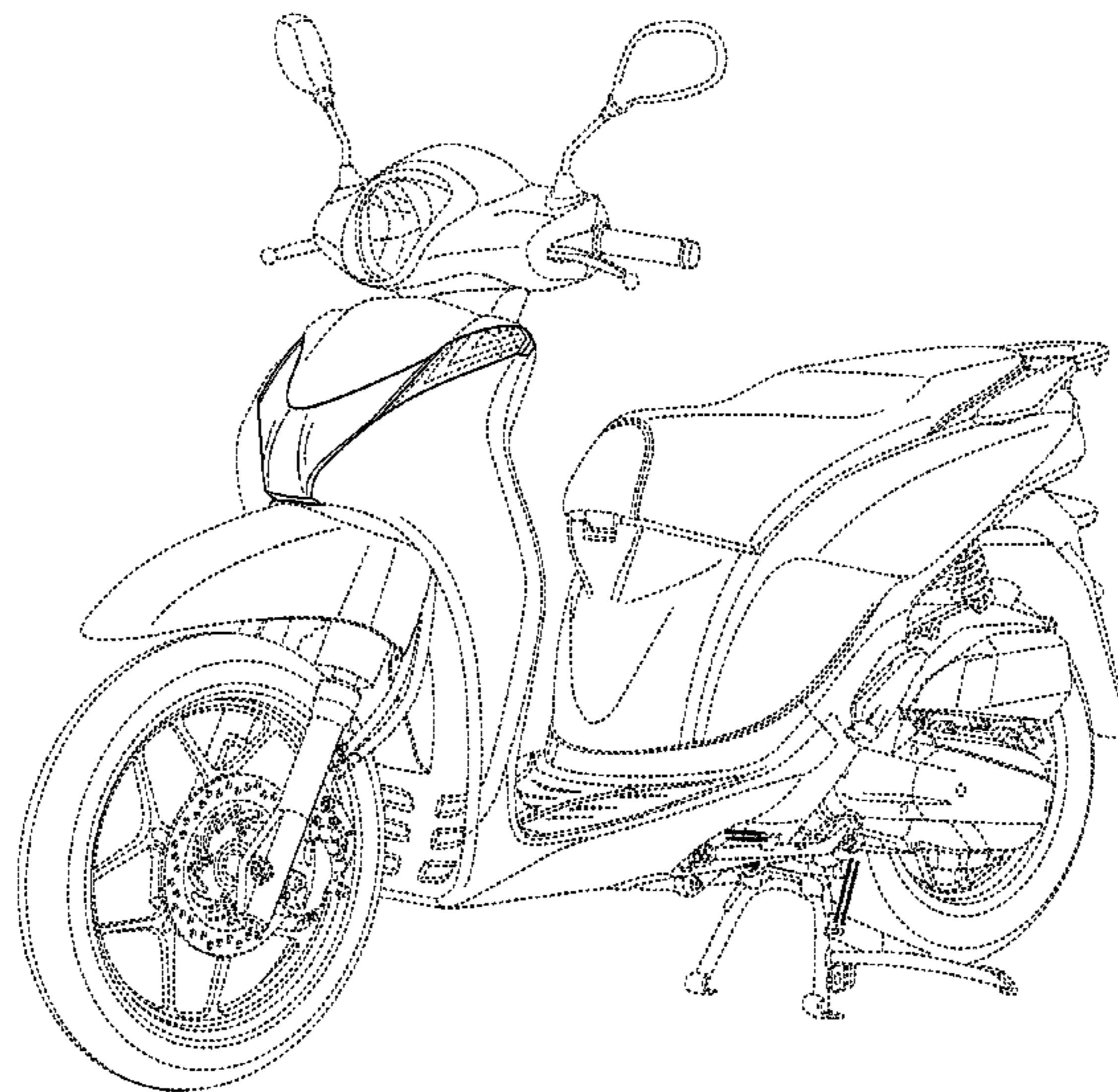

FIG.1

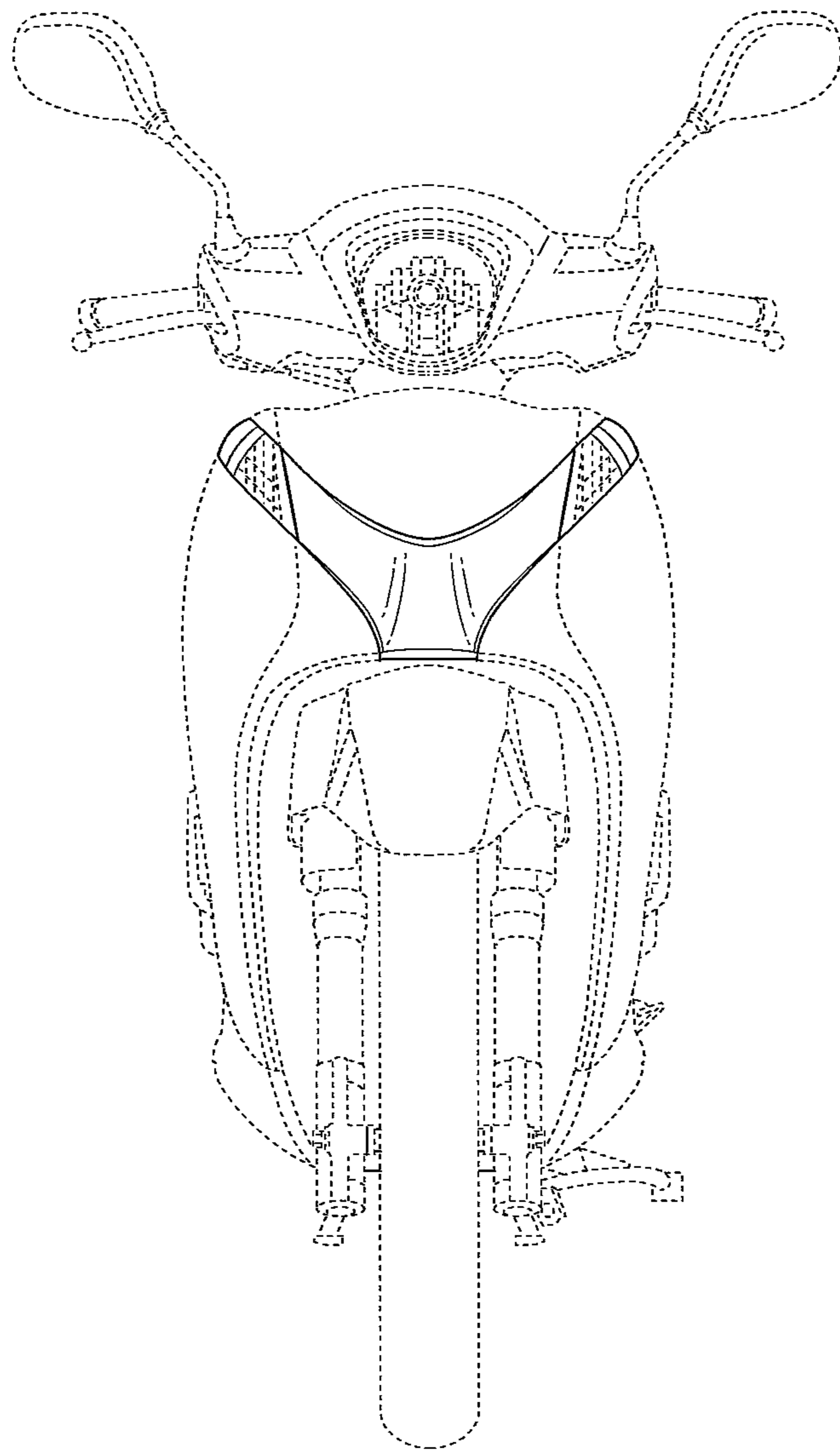

FIG.2

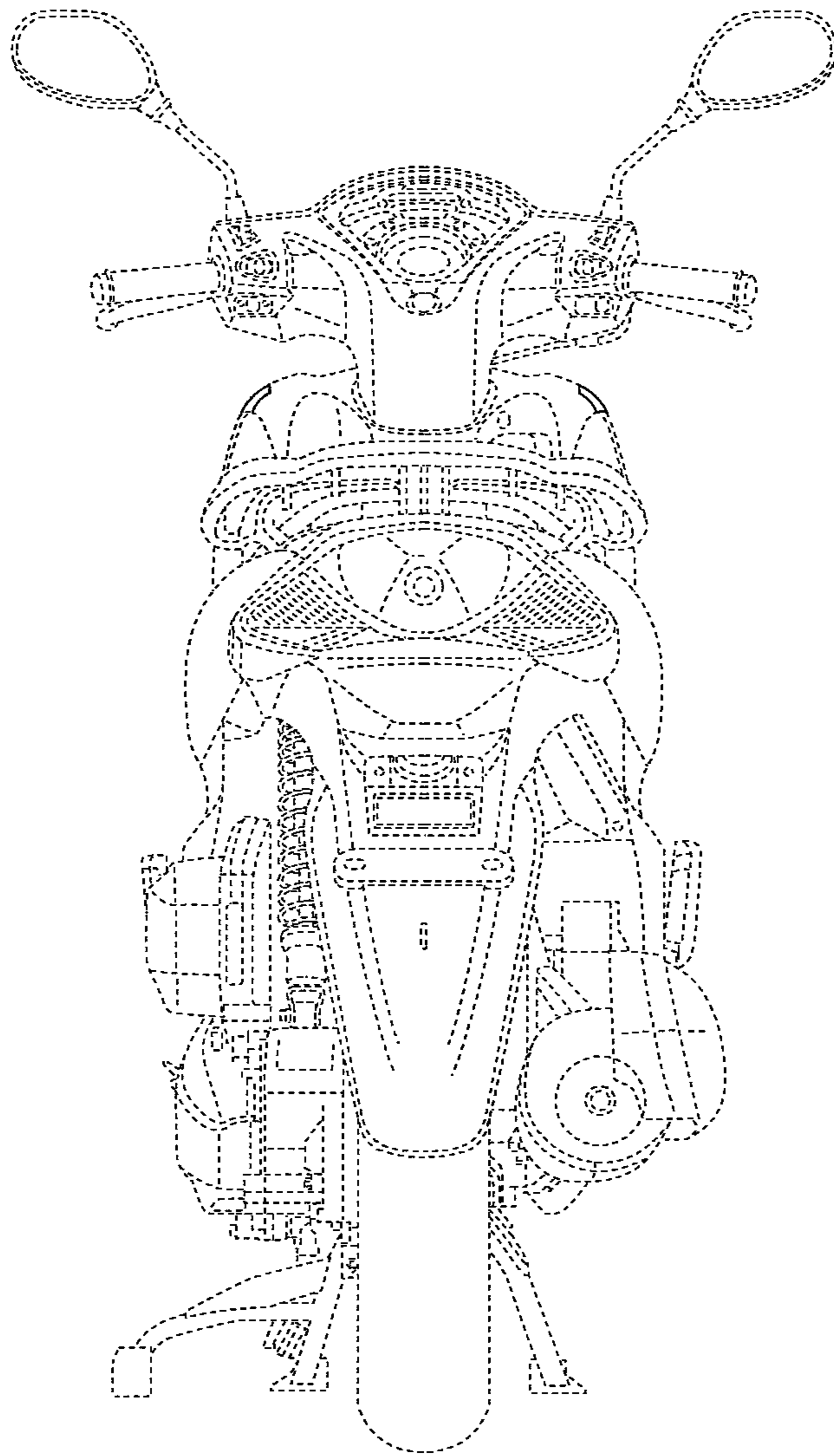

FIG.3

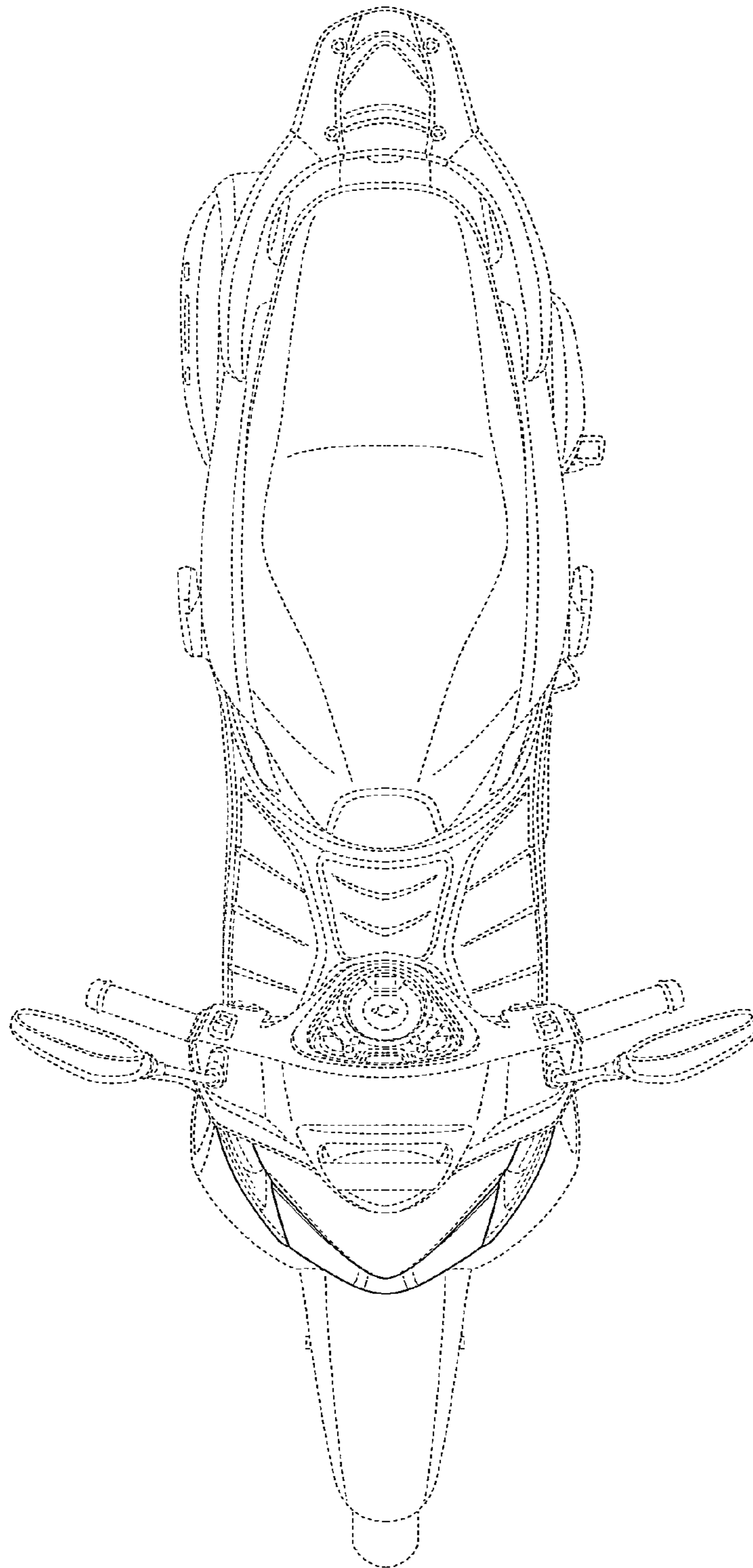

FIG.4

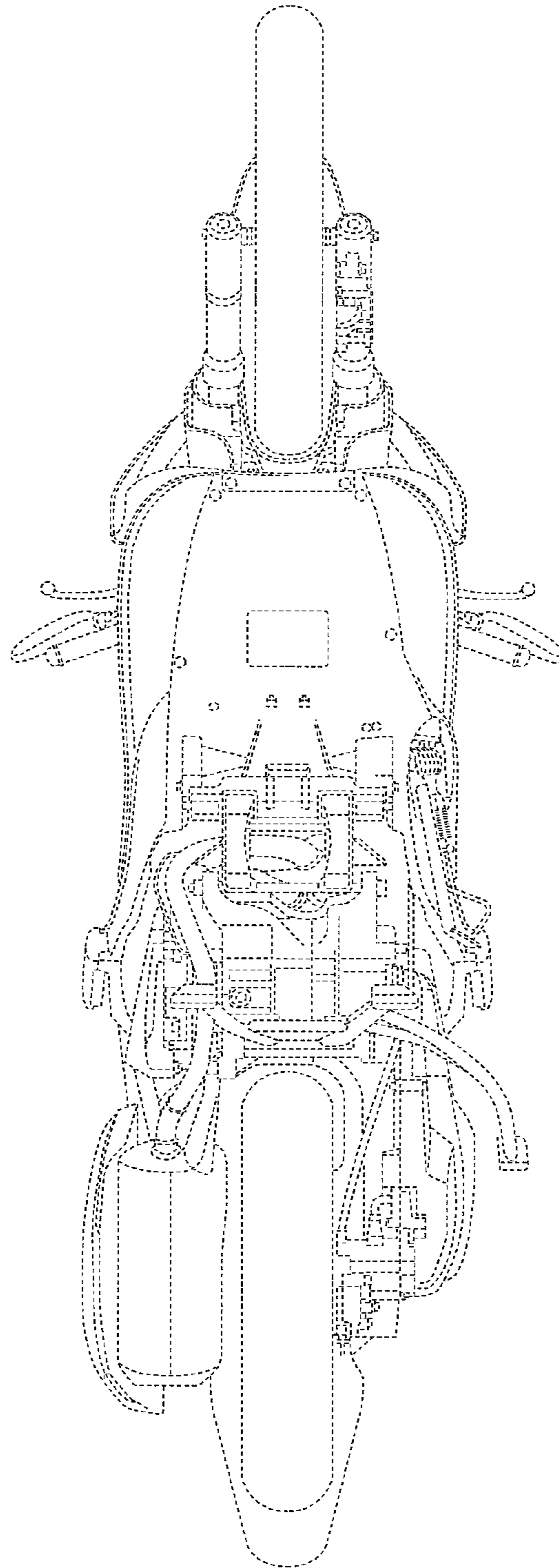

FIG.5

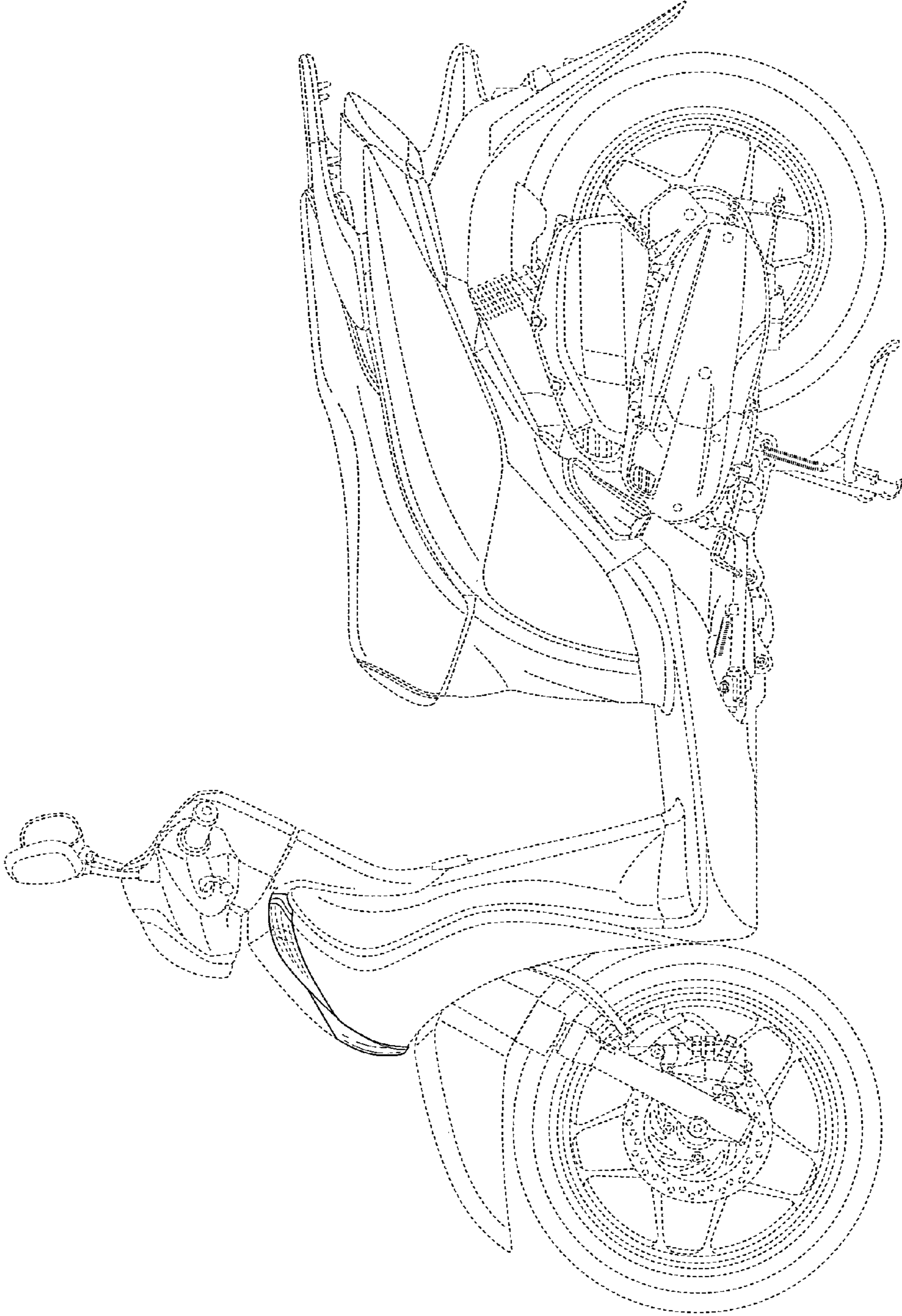

FIG.6

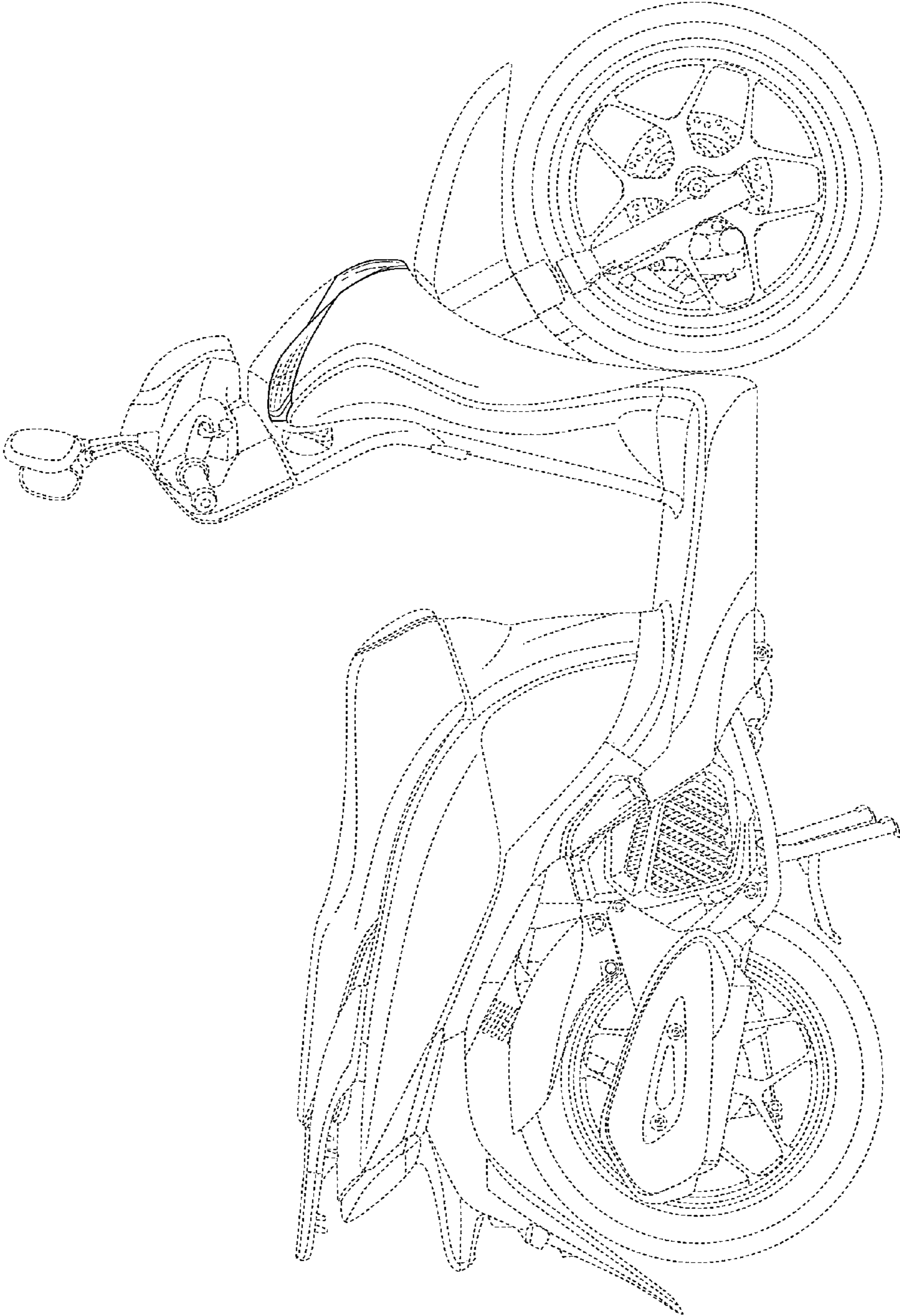

FIG.7

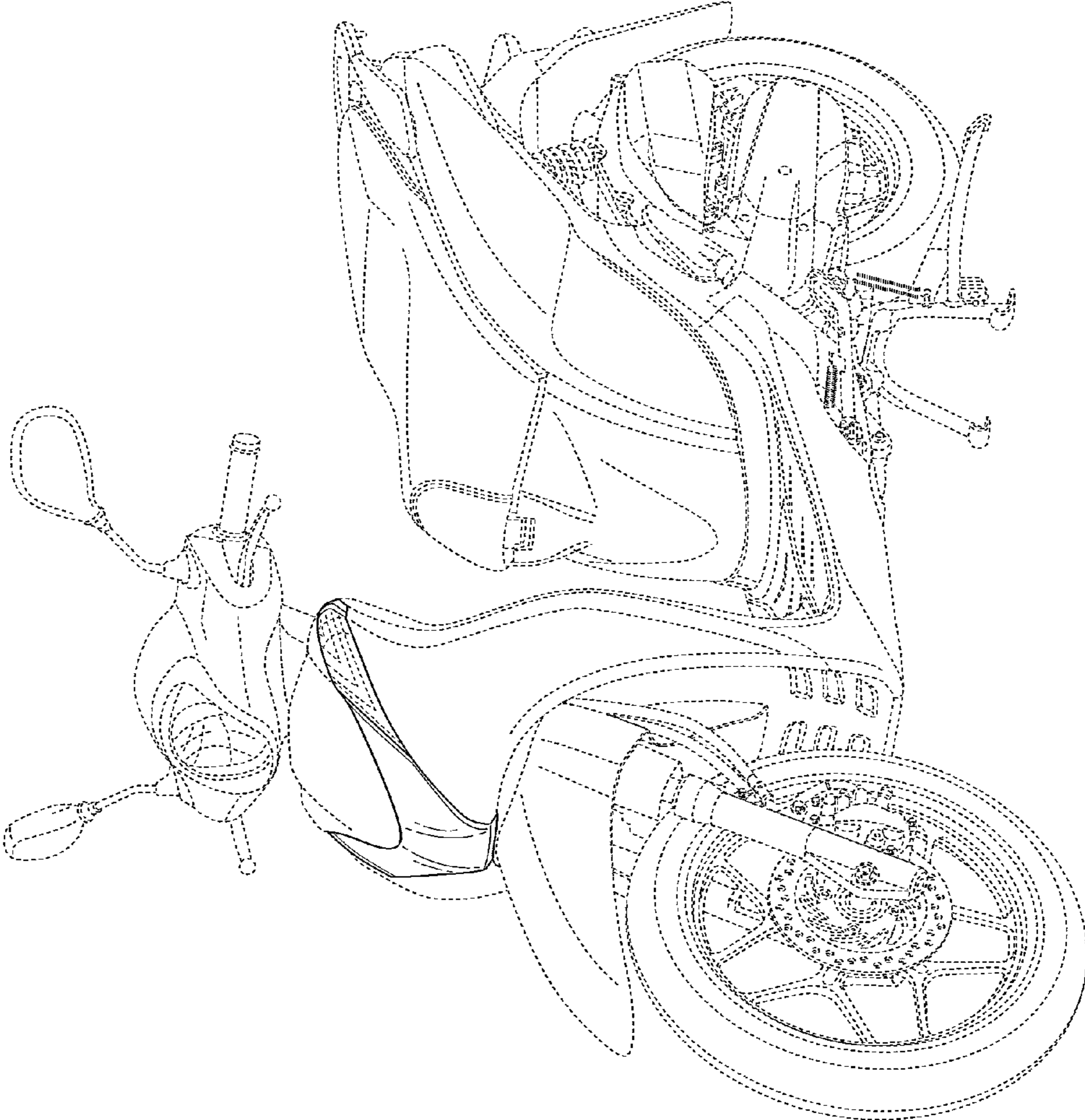

FIG.8

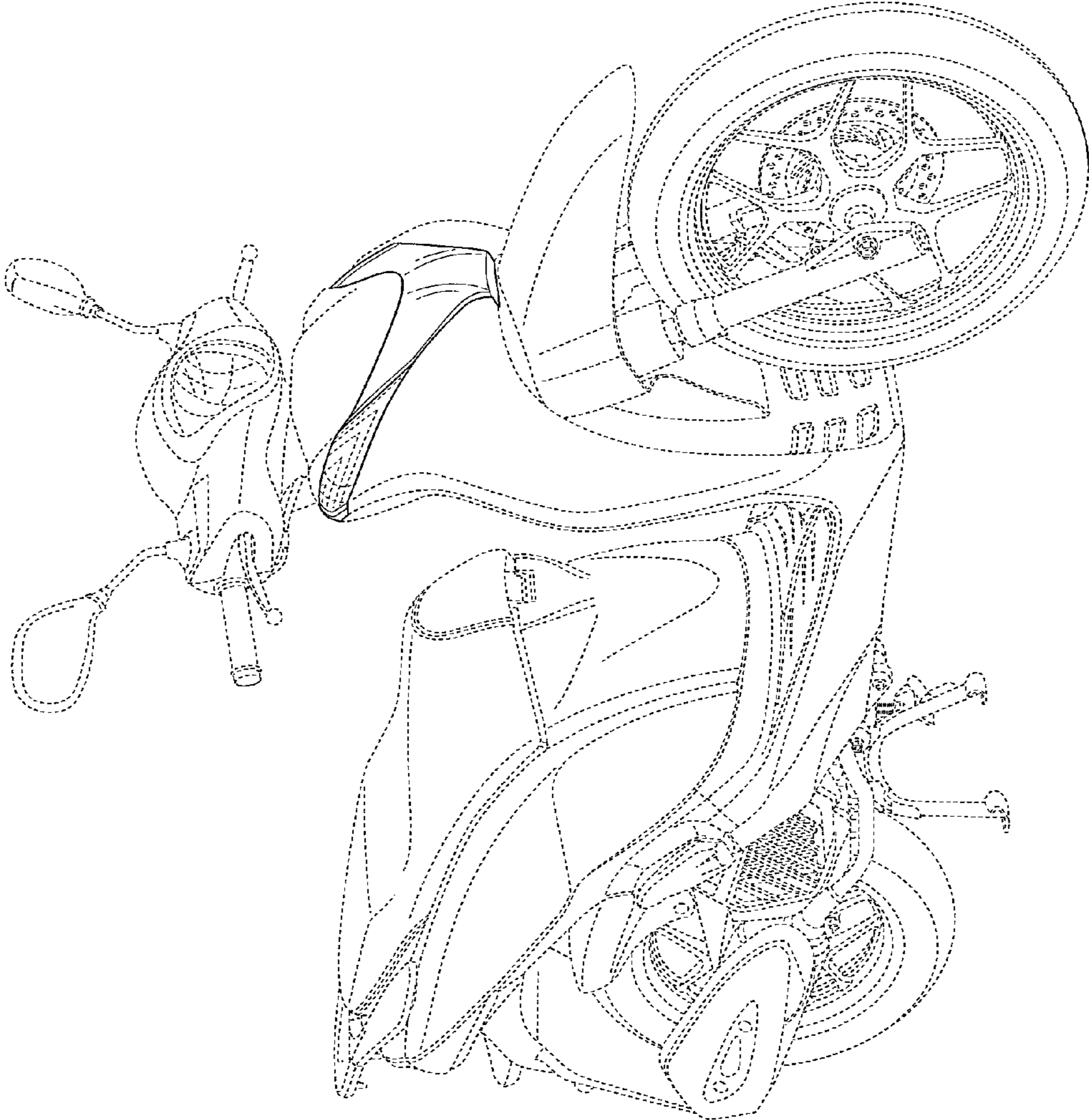

FIG.9

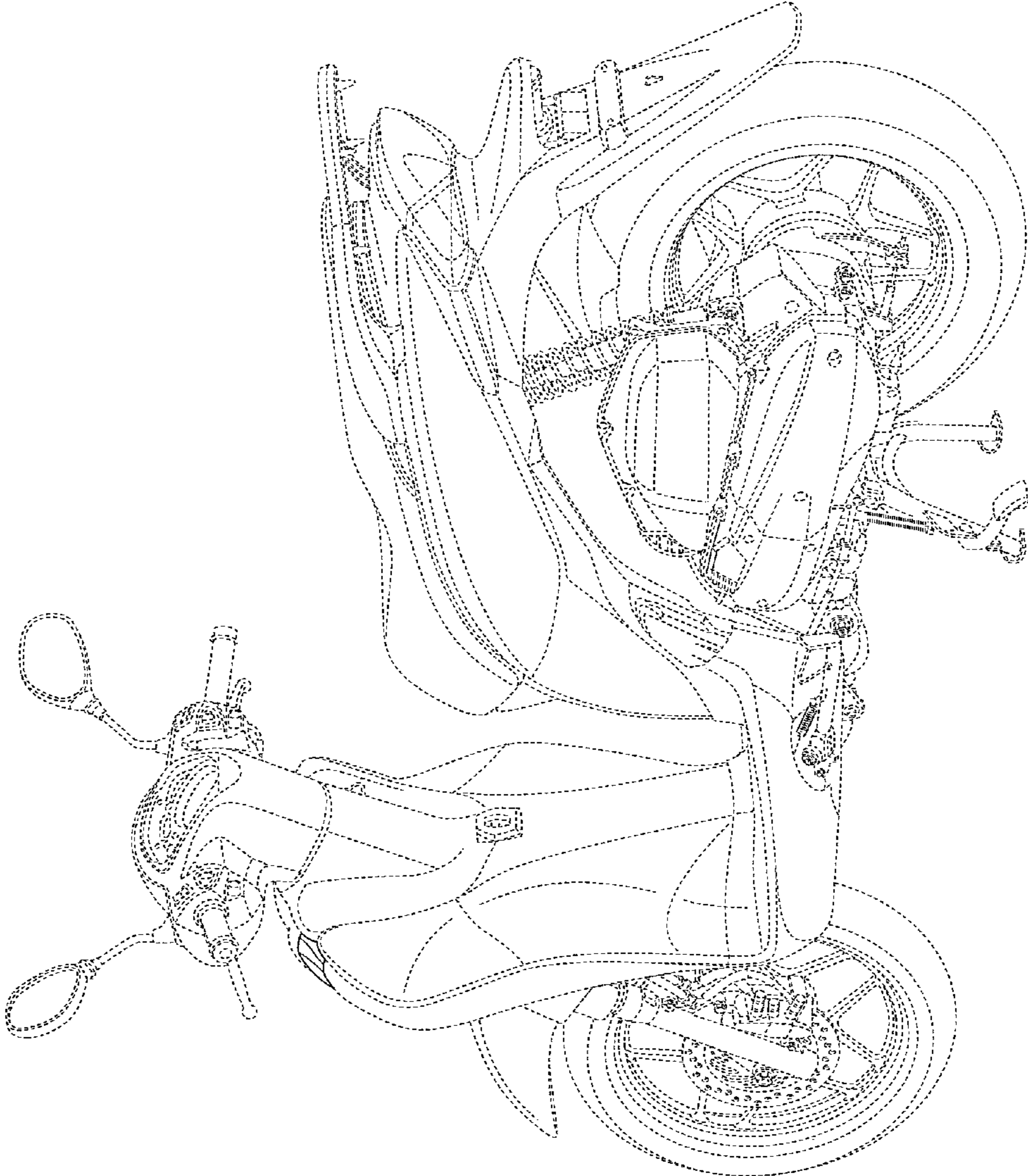

FIG.10

