



US00D731358S

(12) **United States Design Patent**
Mello

(10) **Patent No.:** **US D731,358 S**
(45) **Date of Patent:** **** Jun. 9, 2015**

(54) **JEWELRY SNAP**
(71) Applicant: **Joshua J. Mello**, North Kingstown, RI (US)
(72) Inventor: **Joshua J. Mello**, North Kingstown, RI (US)
(**) Term: **14 Years**
(21) Appl. No.: **29/507,858**
(22) Filed: **Oct. 31, 2014**
(51) **LOC (10) Cl.** **02-07**
(52) **U.S. Cl.**
USPC **D11/220**
(58) **Field of Classification Search**
USPC D11/220, 22, 226, 218; 24/1, 681, 24/689-691, 18, 683, 108, 674, 692, 24/621-623, 671, 662, 618; 292/319; D8/382
CPC A44B 1/08; A44B 17/0088
See application file for complete search history.

7,721,571 B2 5/2010 Rose et al.
7,867,625 B2 * 1/2011 Urata et al. 428/639
8,122,574 B2 * 2/2012 Dammermann 24/681
D665,304 S * 8/2012 Takeda D11/220
D669,810 S 10/2012 McDonnell, Sr. et al.
D678,816 S * 3/2013 Chan D11/220
8,453,265 B2 6/2013 Forte et al.
8,590,185 B1 11/2013 Jardine
2005/0235695 A1 10/2005 Kerleroux et al.
2007/0044512 A1 3/2007 Smith

* cited by examiner

Primary Examiner — Zenia Bennett
(74) *Attorney, Agent, or Firm* — Salter & Michaelson

(57) **CLAIM**
The ornamental design for a jewelry snap, as shown and described.

DESCRIPTION

FIG. 1 is a perspective view on a pocket of a jewelry snap;
FIG. 2 is a perspective view thereof;
FIG. 3 is a front elevational view thereof;
FIG. 4 is a rear elevational view thereof;
FIG. 5 is a left side elevational view thereof;
FIG. 6 is a right side elevational view thereof;
FIG. 7 is a top plan view thereof;
FIG. 8 is a bottom plan view thereof;
FIG. 9 is an exploded perspective front view thereof; and,
FIG. 10 is an exploded perspective rear view thereof.
The broken lines shown in the drawing views are included for the purpose of showing environmental structure that forms no part of the claimed design.

1 Claim, 5 Drawing Sheets

(56) **References Cited**
U.S. PATENT DOCUMENTS
4,604,819 A 8/1986 Grey
D319,201 S * 8/1991 Aoki D11/220
D381,189 S 7/1997 Geliebter
6,178,680 B1 1/2001 Sloom
6,557,994 B1 5/2003 Rose
7,157,152 B2 * 1/2007 Urata et al. 428/639
7,490,386 B2 * 2/2009 Raccosta 24/114.9

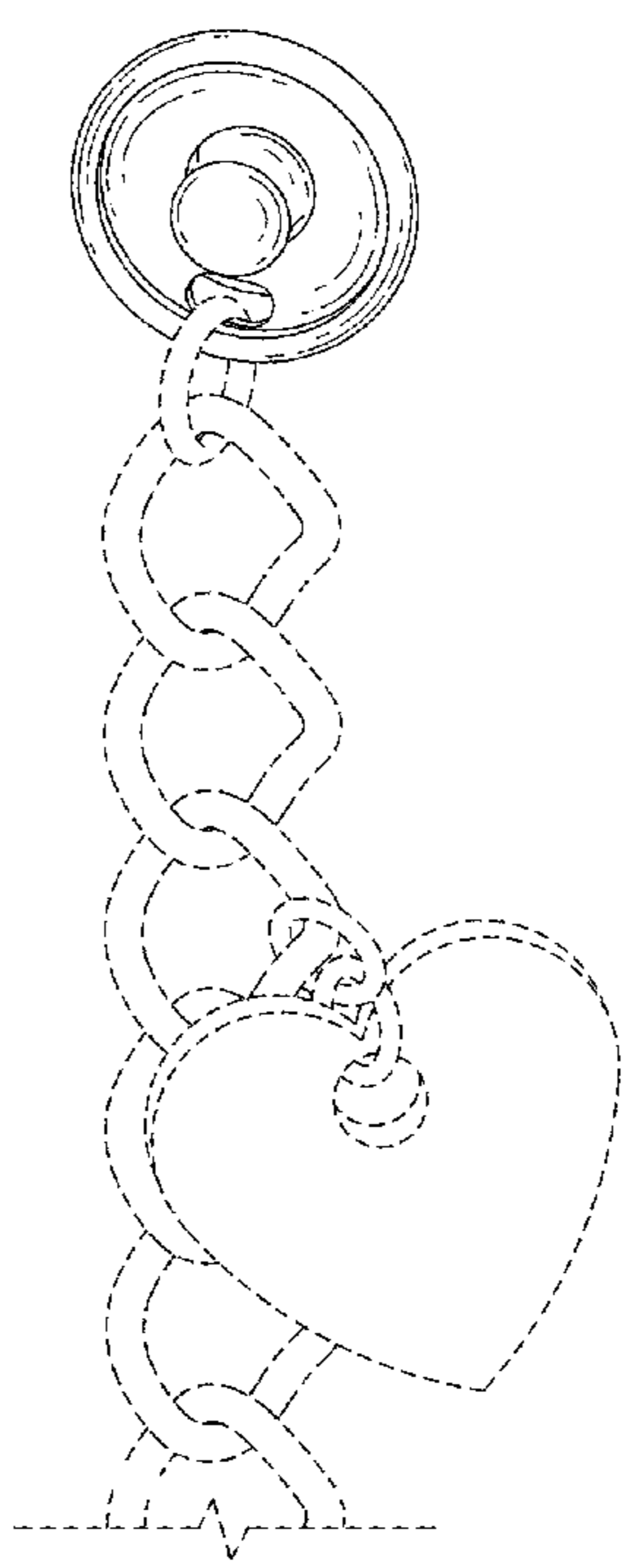

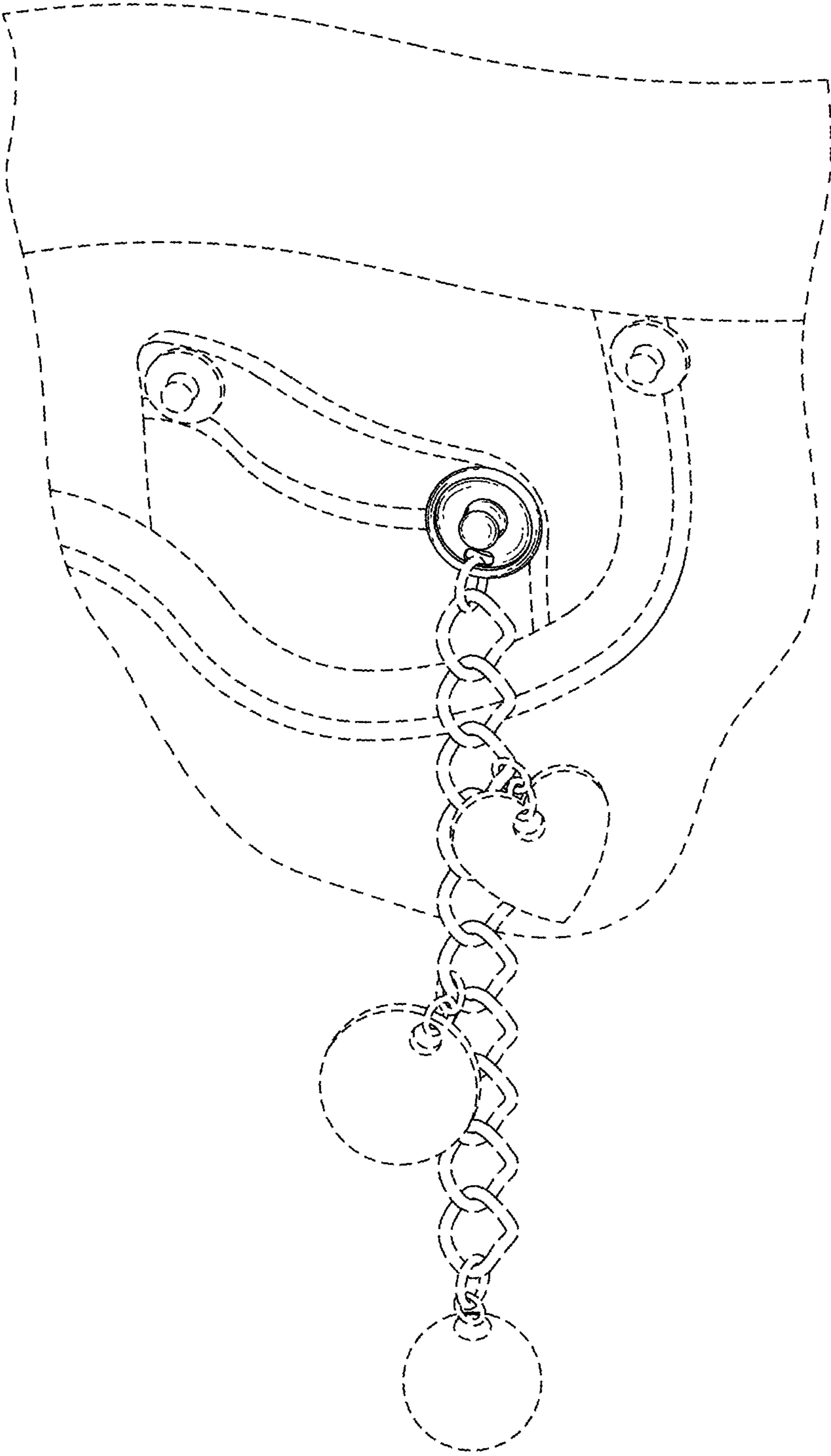

FIG. 1

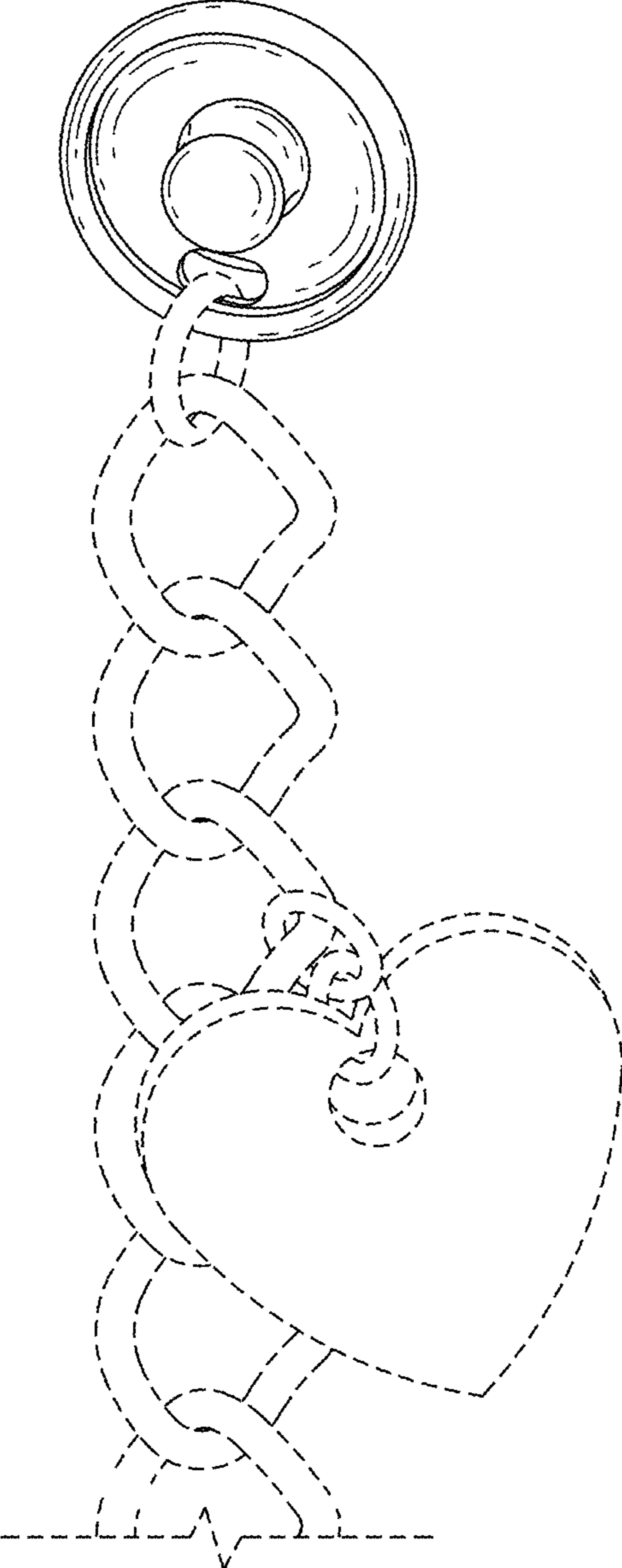

FIG. 2

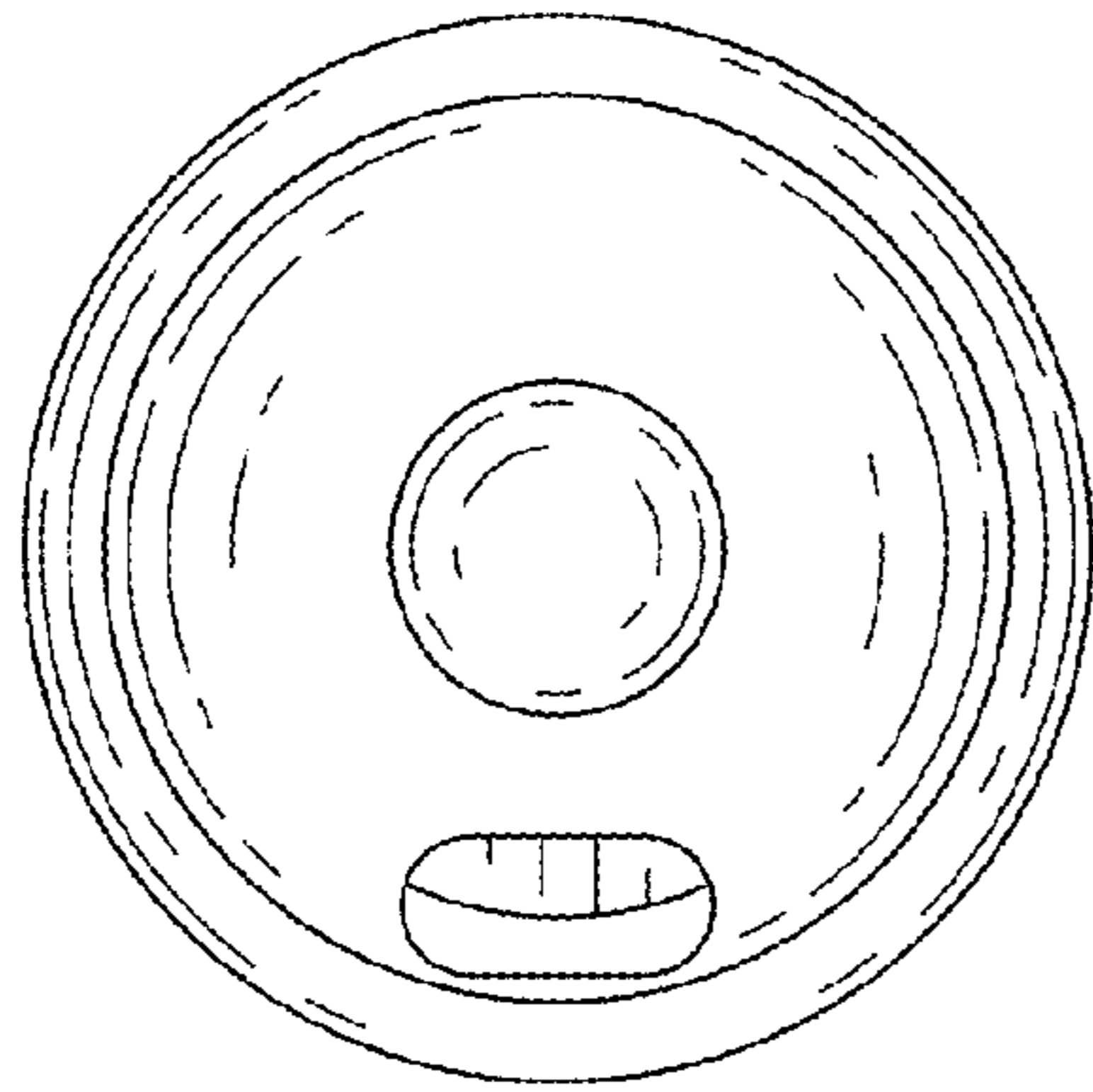

FIG. 3

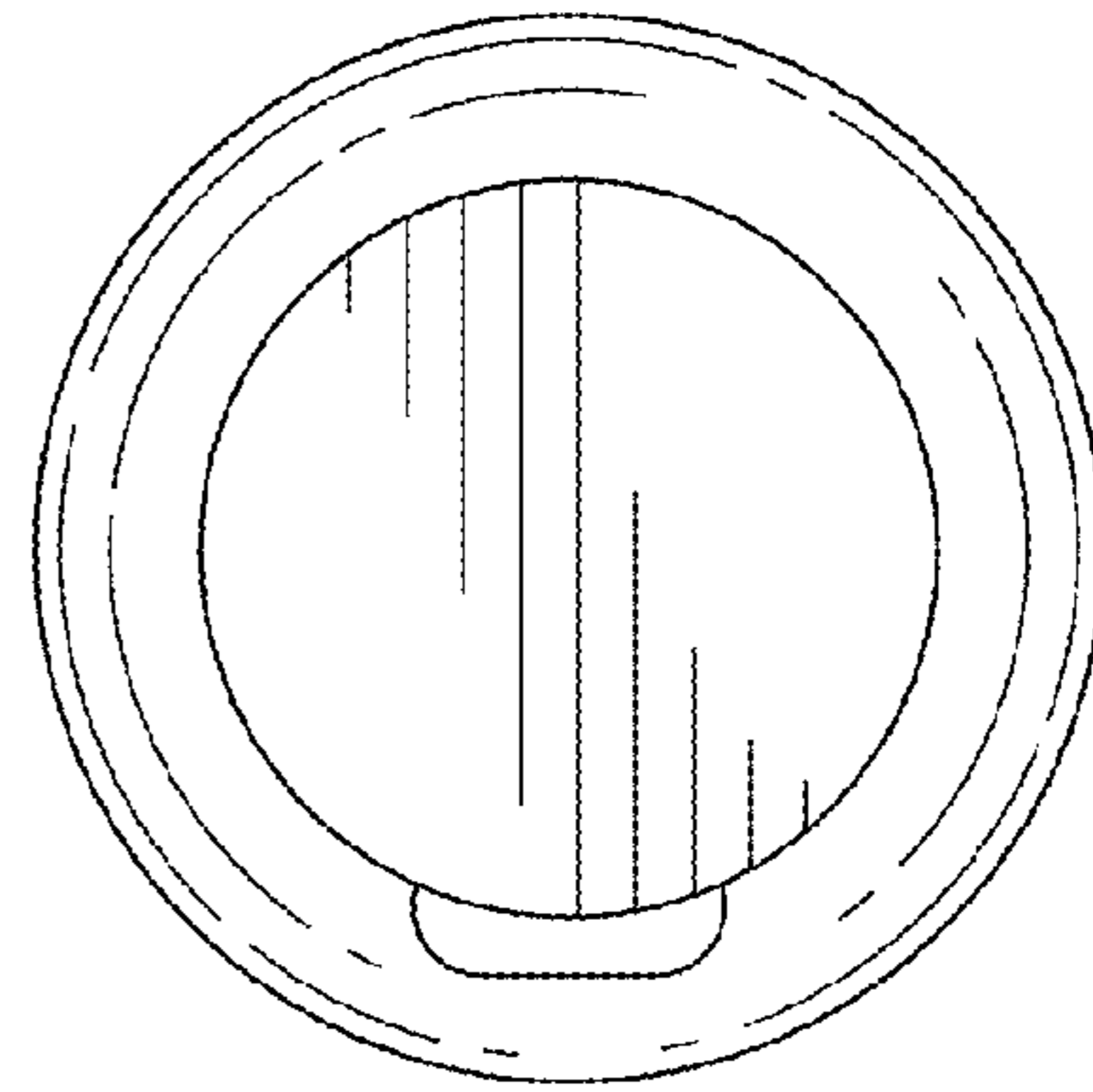

FIG. 4

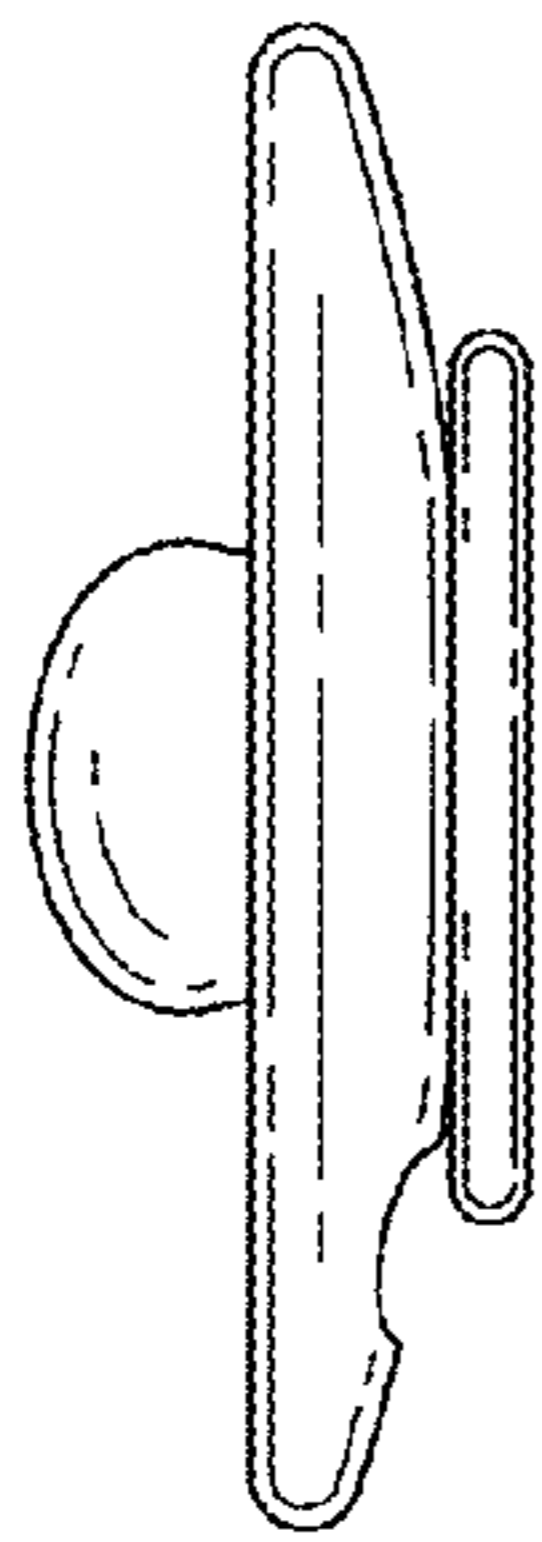

FIG. 5

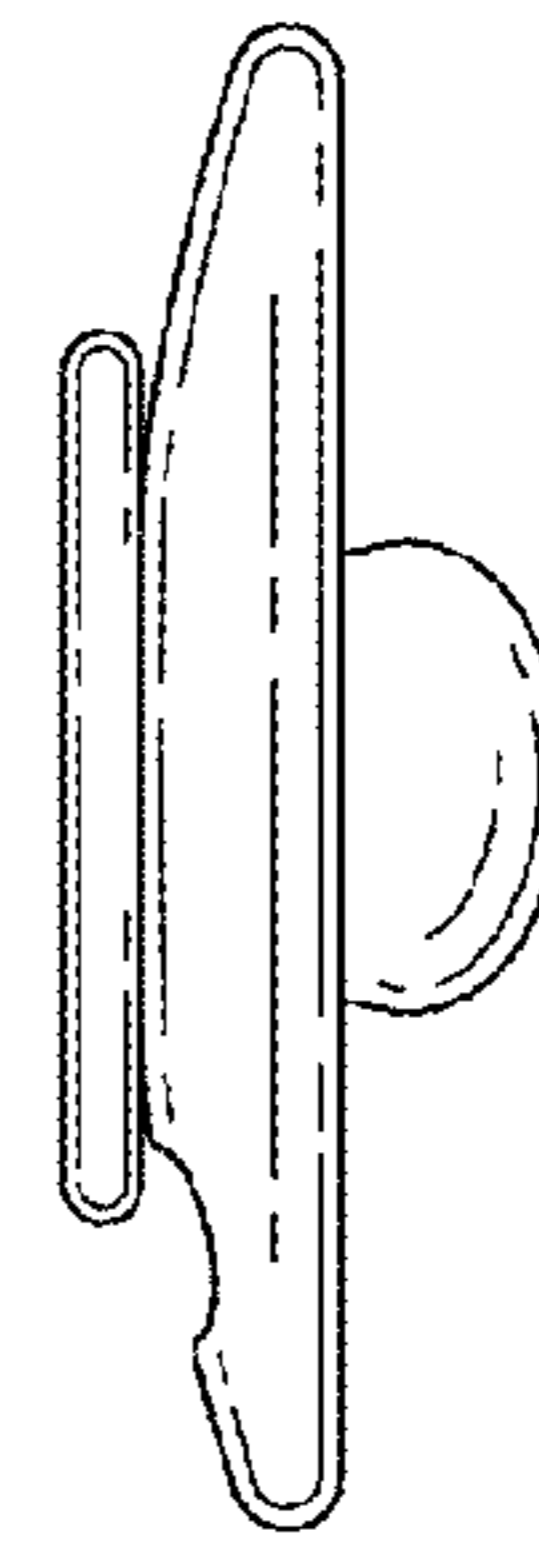

FIG. 6

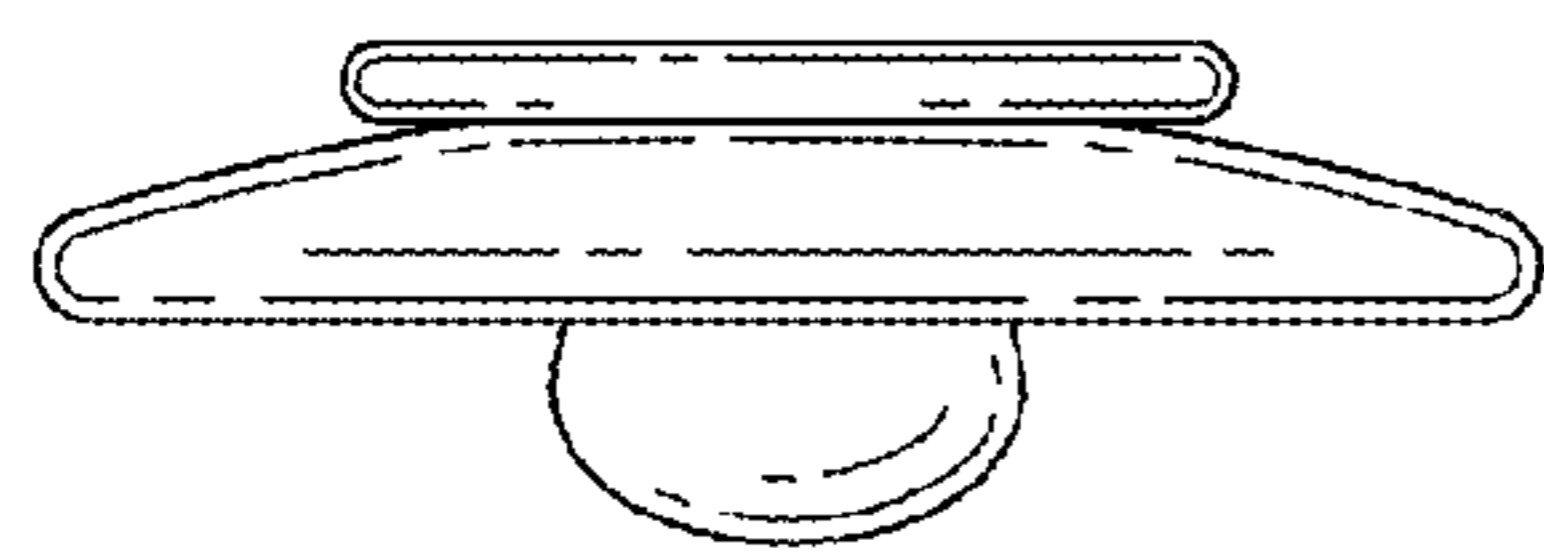

FIG. 7

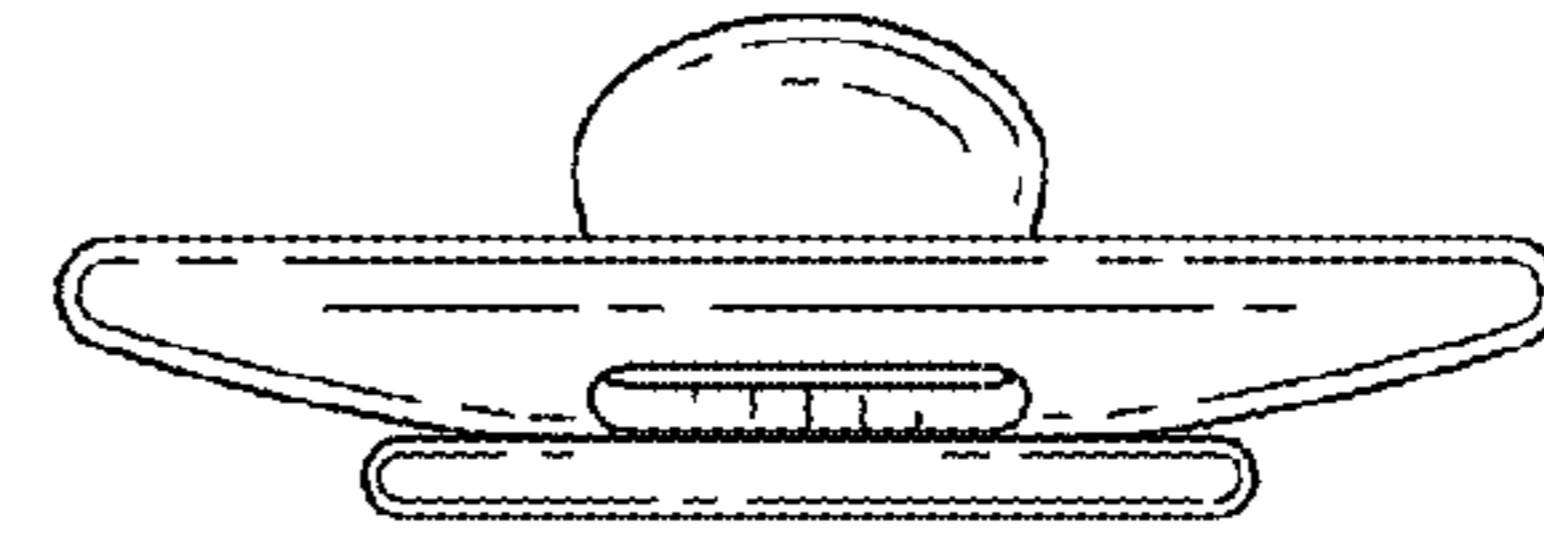

FIG. 8

