



US00D731336S

(12) **United States Design Patent**
Klemm

(10) **Patent No.:** **US D731,336 S**
(45) **Date of Patent:** **** Jun. 9, 2015**

(54) **MEASURING TAPE**
(71) Applicant: **Rebecca Klemm**, Washington, DC (US)
(72) Inventor: **Rebecca Klemm**, Washington, DC (US)
(**) Term: **14 Years**
(21) Appl. No.: **29/477,058**
(22) Filed: **Dec. 19, 2013**
(51) **LOC (10) Cl.** **10-04**
(52) **U.S. Cl.**
USPC **D10/72**
(58) **Field of Classification Search**
USPC D10/72
CPC G01B 3/004; G01B 3/006; G01B 3/10;
G01B 3/1084; G01B 3/1082; G01B 3/1056;
G01B 3/563; G01B 3/566; G01B 3/1071;
G01B 2003/1015; G01B 2003/103; G01B
2003/1038; G01B 2003/102; G07B 3/10
See application file for complete search history.

(56) **References Cited**

U.S. PATENT DOCUMENTS

1,988,095 A * 1/1935 Stockman 33/27.03
2,410,713 A * 11/1946 Carlson 242/396.5

(Continued)

Primary Examiner — Antoine D Davis

(74) *Attorney, Agent, or Firm* — Venable LLP; Steven J. Schwarz

(57) **CLAIM**

The ornamental design for measuring tape, as shown and described.

DESCRIPTION

FIG. 1 is a perspective view of a measuring tape according to a second embodiment of the claimed design;
FIG. 2 is a front elevational view of the measuring tape of FIG. 1;
FIG. 3 is a rear elevational view of the measuring tape of FIG. 1;
FIG. 4 is a right-side elevational view of the measuring tape of FIG. 1;
FIG. 5 is a left-side elevational view of the measuring tape of FIG. 1;
FIG. 6 is a top elevational view of the measuring tape of FIG. 1;

FIG. 7 is a bottom elevational view of the measuring tape of FIG. 1;
FIG. 8 is a perspective view of a measuring tape according to a third embodiment of the claimed design;
FIG. 9 is a front elevational view of the measuring tape of FIG. 8;
FIG. 10 is a rear elevational view of the measuring tape of FIG. 8;
FIG. 11 is a right-side elevational view of the measuring tape of FIG. 8;
FIG. 12 is a left-side elevational view of the measuring tape of FIG. 8;
FIG. 13 is a top elevational view of the measuring tape of FIG. 8;
FIG. 14 is a bottom elevational view of the measuring tape of FIG. 8;
FIG. 15 is a perspective view of a measuring tape according to a fourth embodiment of the claimed design;
FIG. 16 is a front elevational view of the measuring tape of FIG. 15;
FIG. 17 is a rear elevational view of the measuring tape of FIG. 15;
FIG. 18 is a right-side elevational view of the measuring tape of FIG. 15;
FIG. 19 is a left-side elevational view of the measuring tape of FIG. 15;
FIG. 20 is a top elevational view of the measuring tape of FIG. 15;
FIG. 21 is a bottom elevational view of the measuring tape of FIG. 15;
FIG. 22 is a perspective view of a measuring tape according to a fifth embodiment of the claimed design;
FIG. 23 is a front elevational view of the measuring tape of FIG. 22;
FIG. 24 is a rear elevational view of the measuring tape of FIG. 22;
FIG. 25 is a right-side elevational view of the measuring tape of FIG. 22;
FIG. 26 is a left-side elevational view of the measuring tape of FIG. 22;
FIG. 27 is a top elevational view of the measuring tape of FIG. 22; and,
FIG. 28 is a bottom elevational view of the measuring tape of FIG. 22.
The features shown in broken lines are environment only and not part of the claimed design.

1 Claim, 20 Drawing Sheets

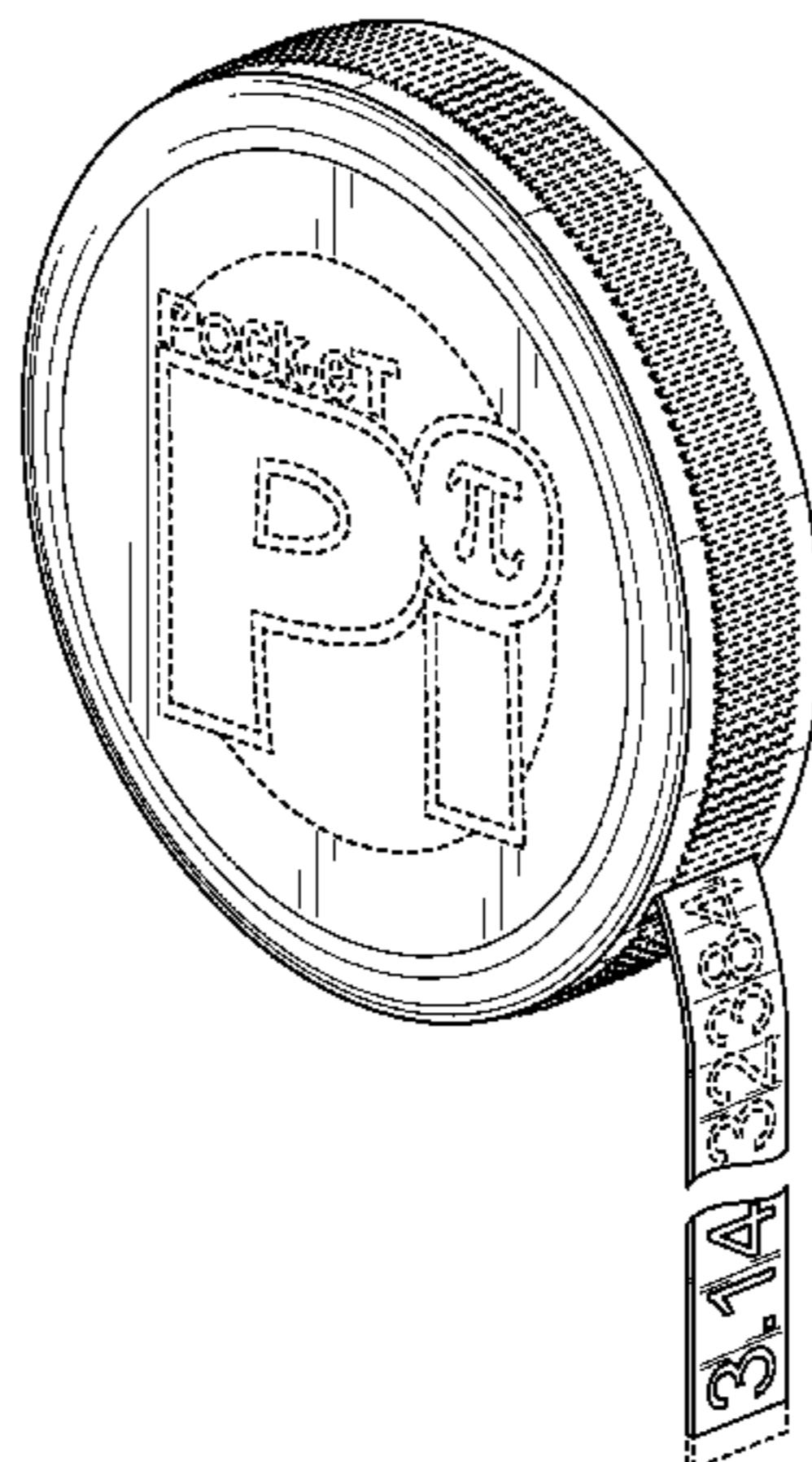

(56)

References Cited

U.S. PATENT DOCUMENTS

2,549,098	A *	4/1951	Joseph	242/381.3	4,708,755	A *	11/1987	Lambelet	156/64
2,559,111	A *	7/1951	Carroll, Jr. et al.	242/381.6	4,756,087	A *	7/1988	Sing	33/765
2,835,038	A *	5/1958	Perrin	33/764	D304,425	S *	11/1989	Hara et al.	D10/72
2,914,269	A *	11/1959	Freeman	242/405	5,056,234	A *	10/1991	Han	33/494
2,997,251	A *	8/1961	Chafin	242/372	D387,062	S *	12/1997	Heine	D14/230
3,228,626	A *	1/1966	Quenot	242/396.9	5,727,323	A *	3/1998	Cerrato	30/459
D279,459	S *	7/1985	On	D10/31	5,845,407	A *	12/1998	Cerrato	30/459
D285,909	S *	9/1986	Lamson	D10/72	D435,226	S *	12/2000	Bayer et al.	D10/72
					6,290,158	B1 *	9/2001	Huang	242/379
					D455,087	S *	4/2002	Bayer et al.	D10/72
					D556,063	S *	11/2007	Chue	D10/72

* cited by examiner

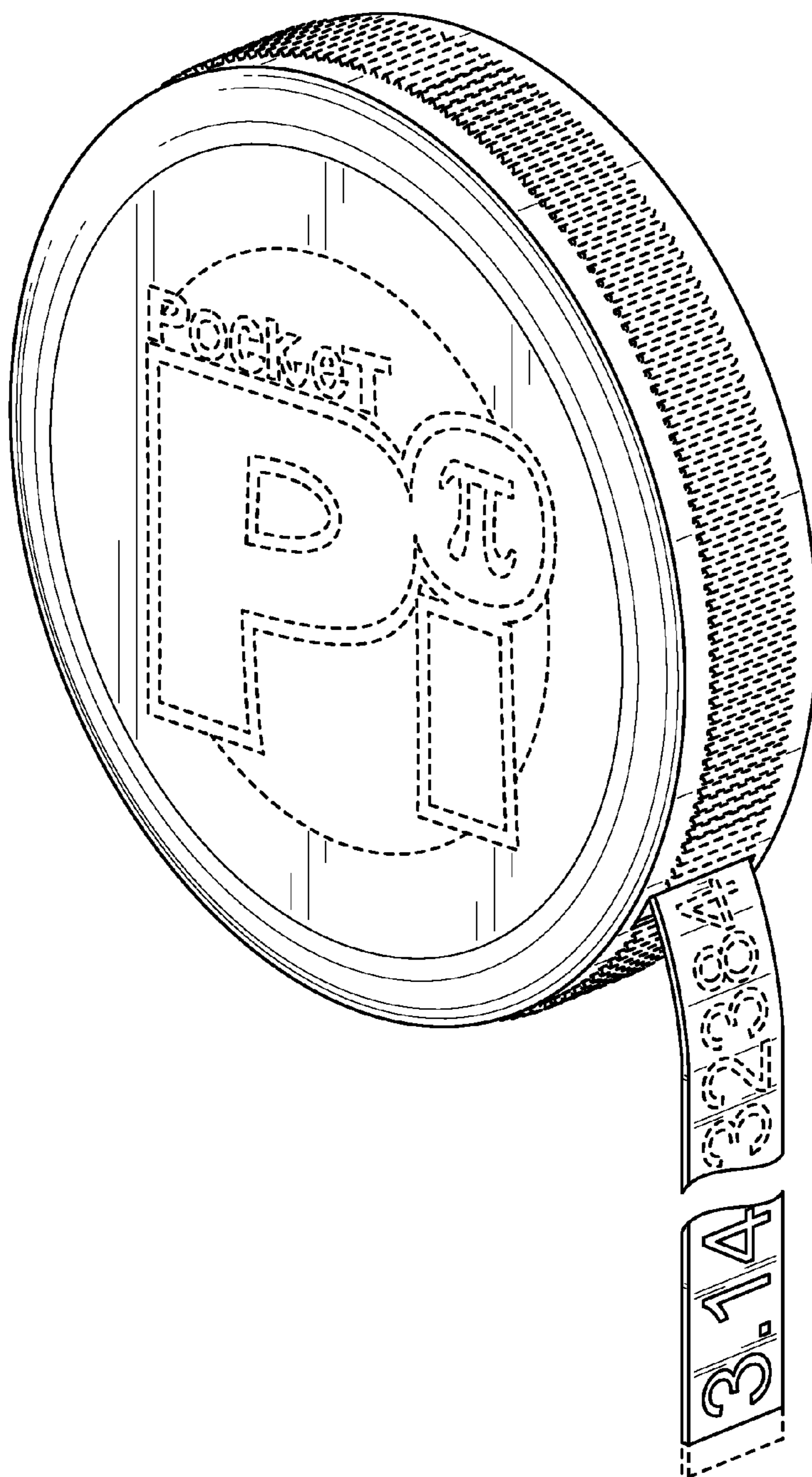

FIG. 1

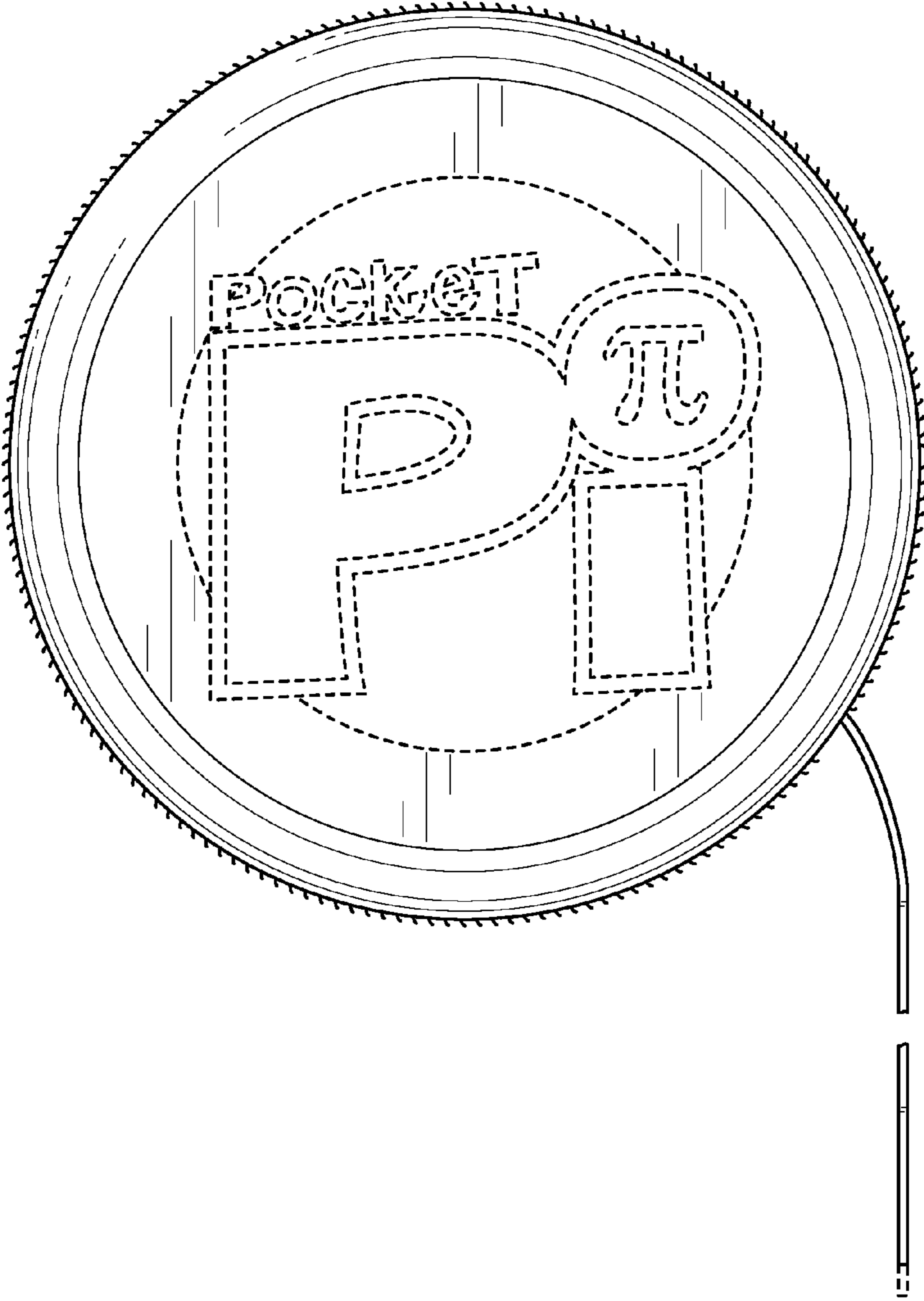

FIG. 2

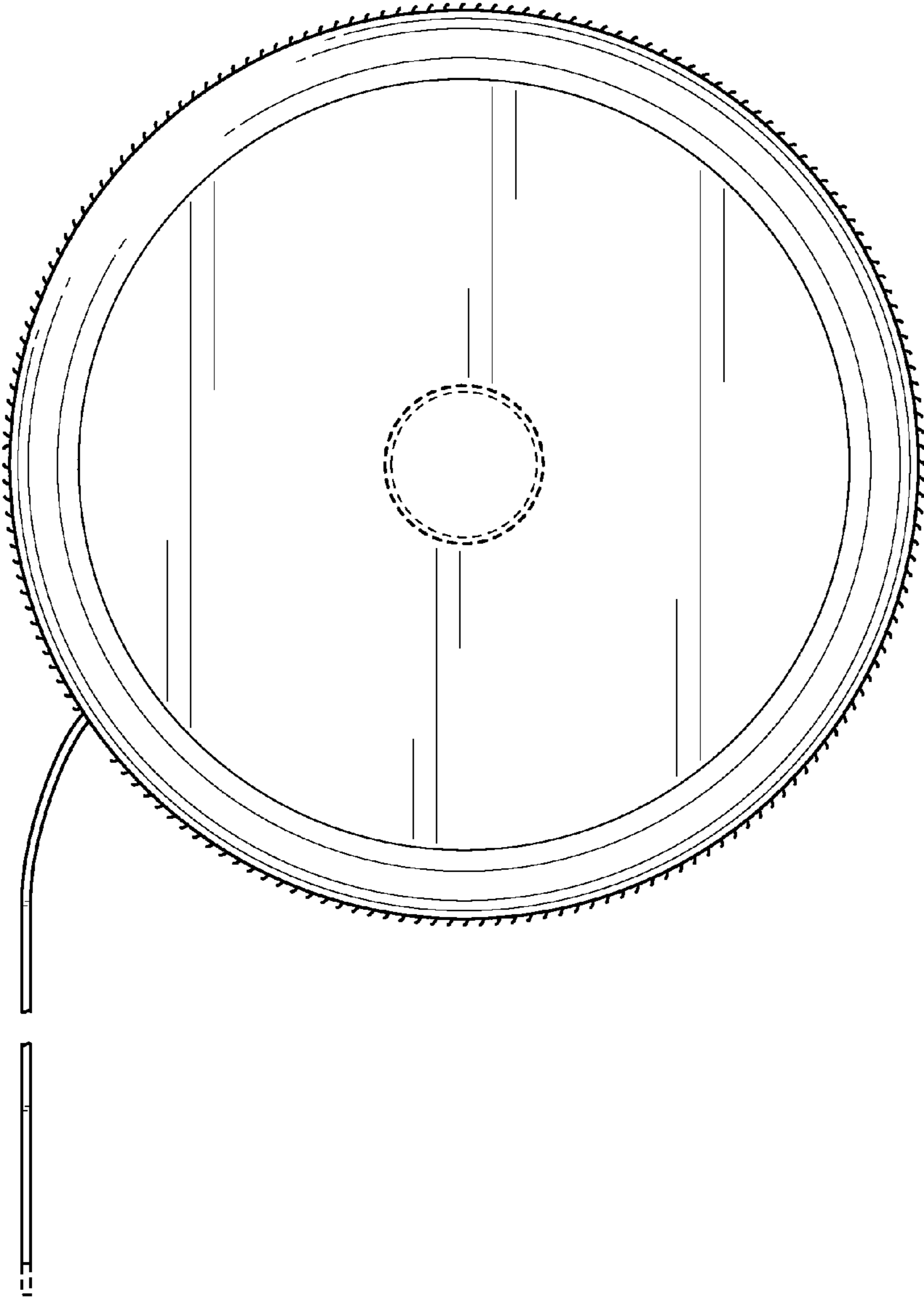

FIG. 3

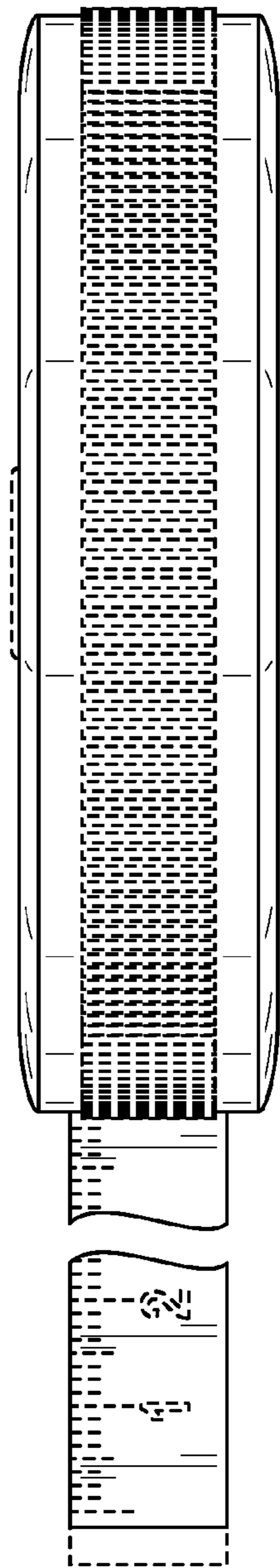

FIG. 4

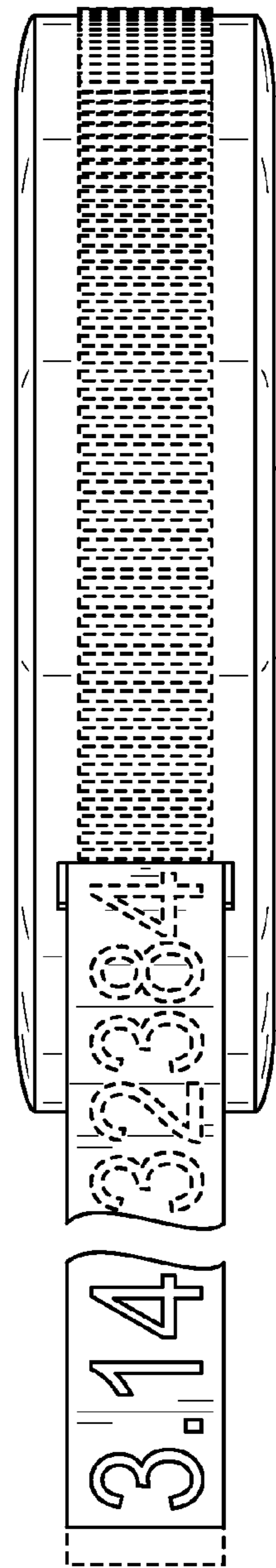

FIG. 5

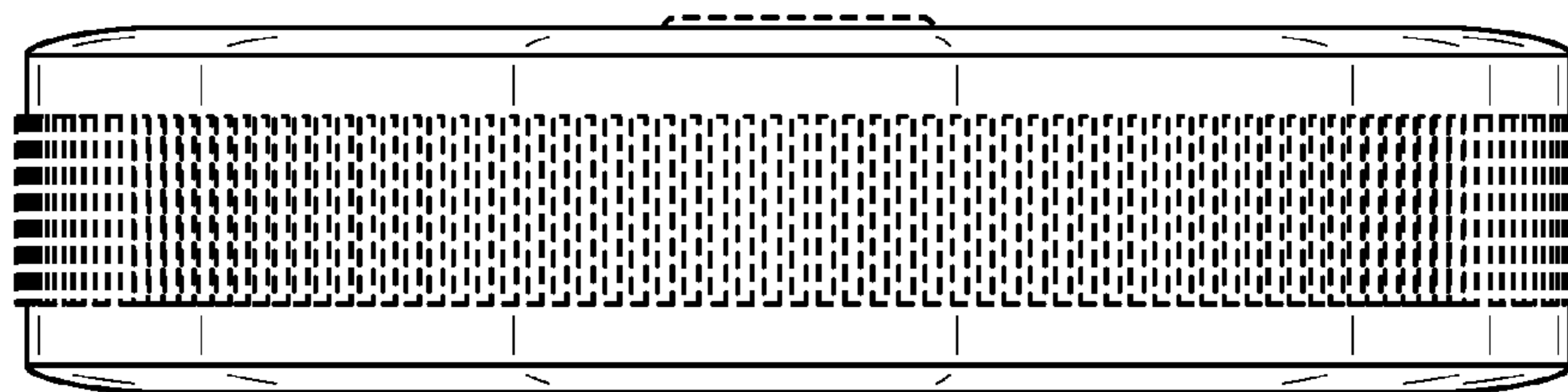

FIG. 6

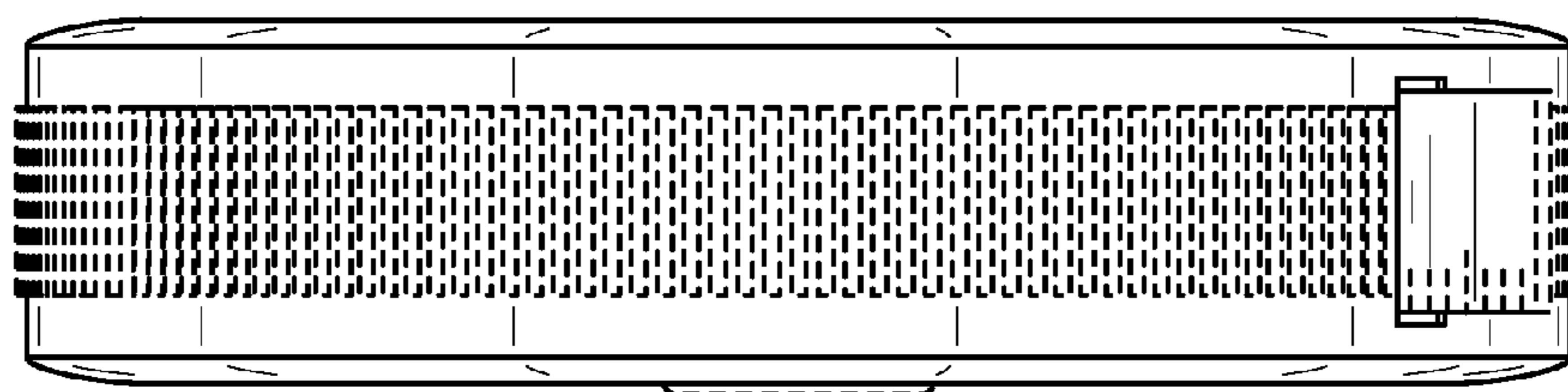

FIG. 7

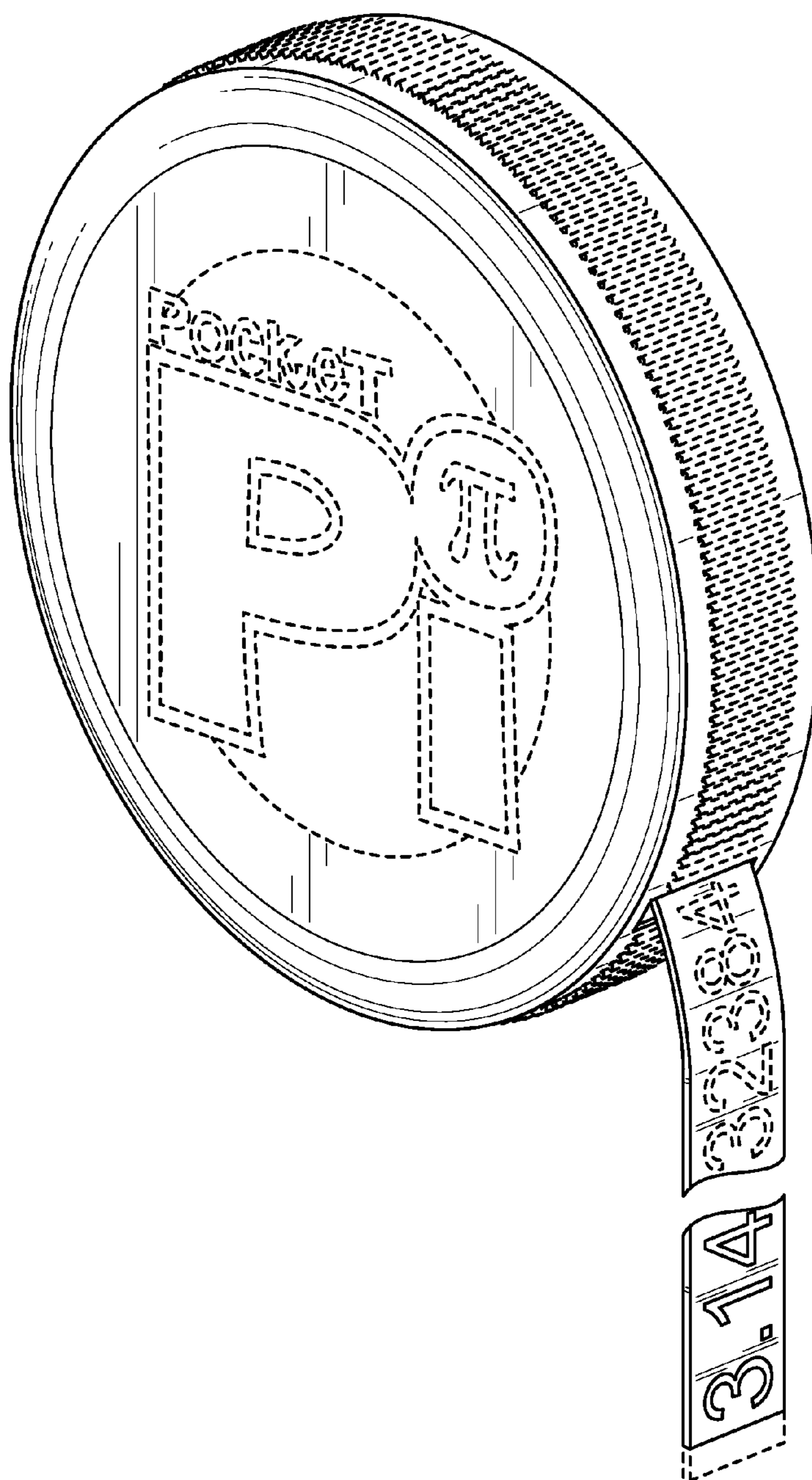

FIG. 8

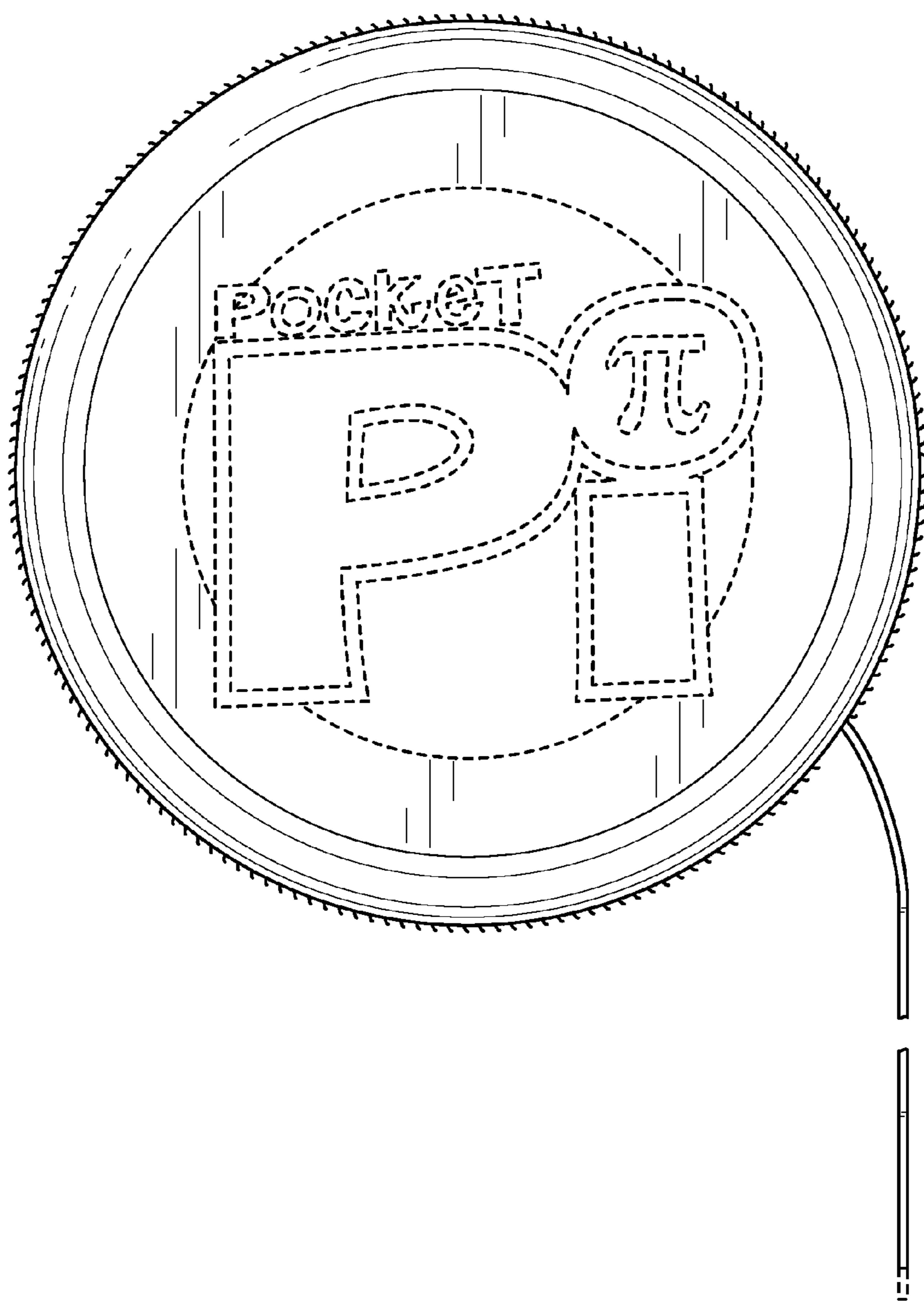

FIG. 9

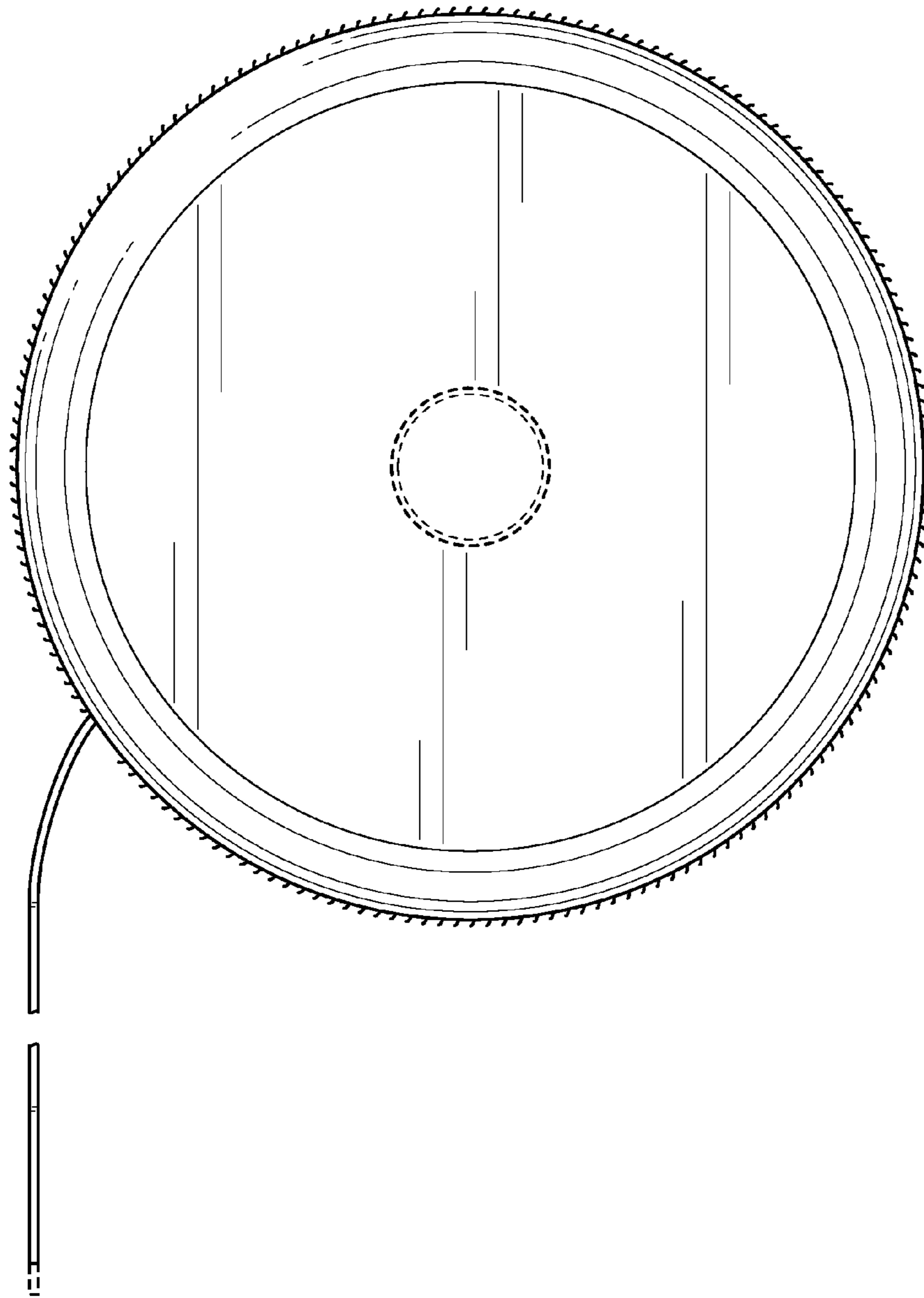

FIG. 10

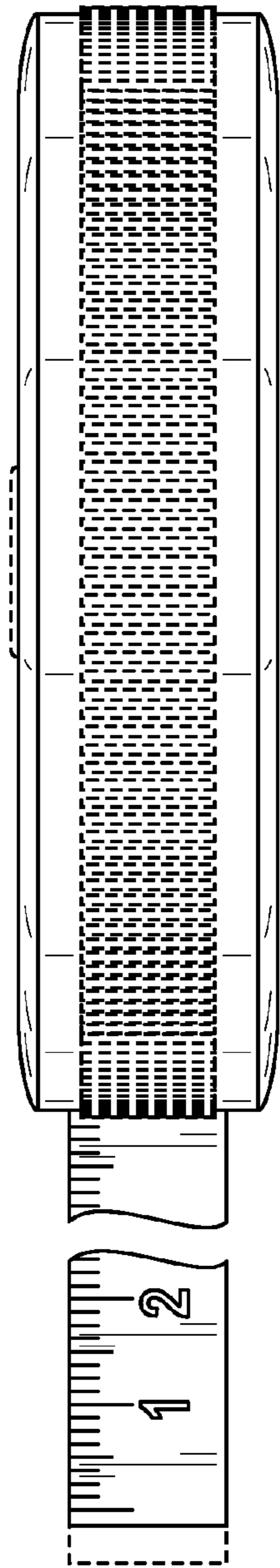

FIG. 11

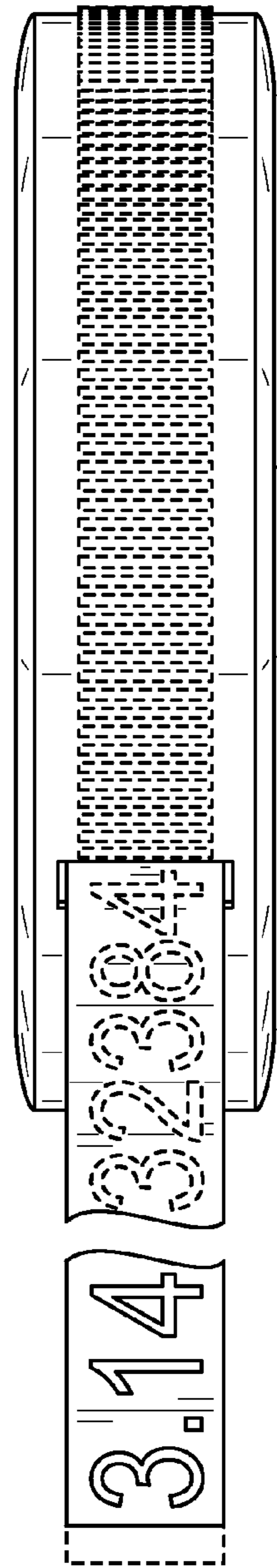

FIG. 12

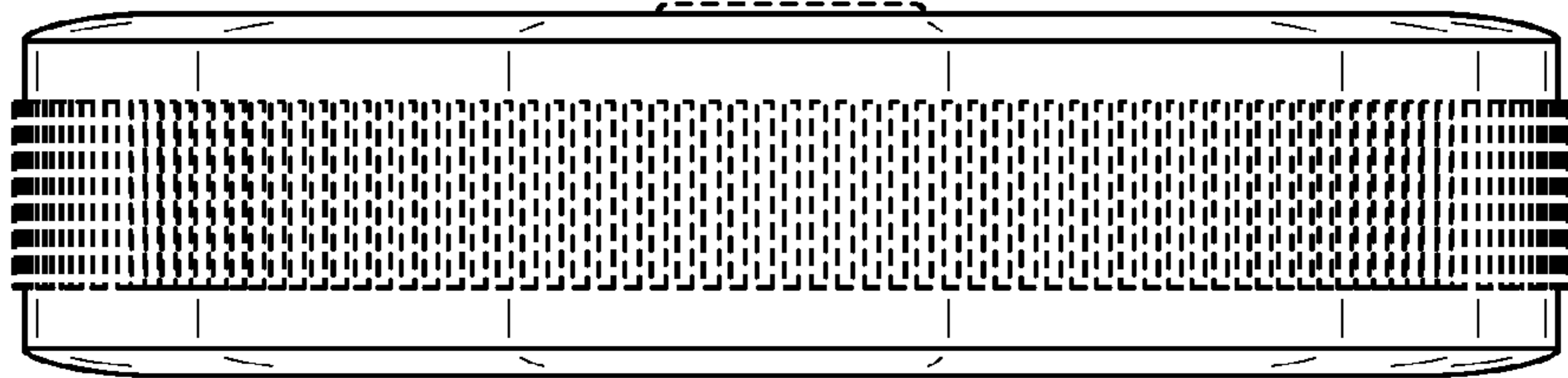

FIG. 13

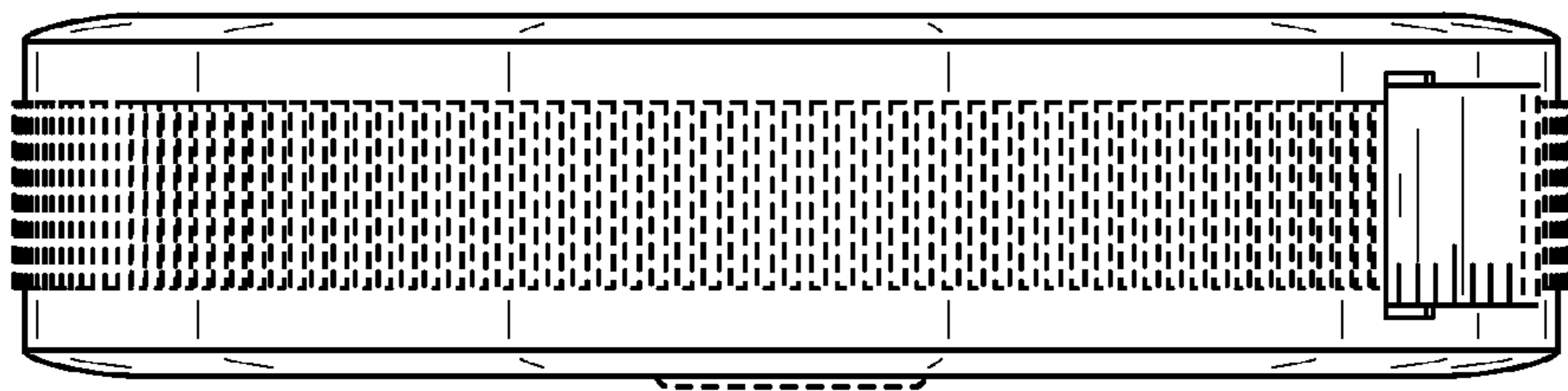

FIG. 14

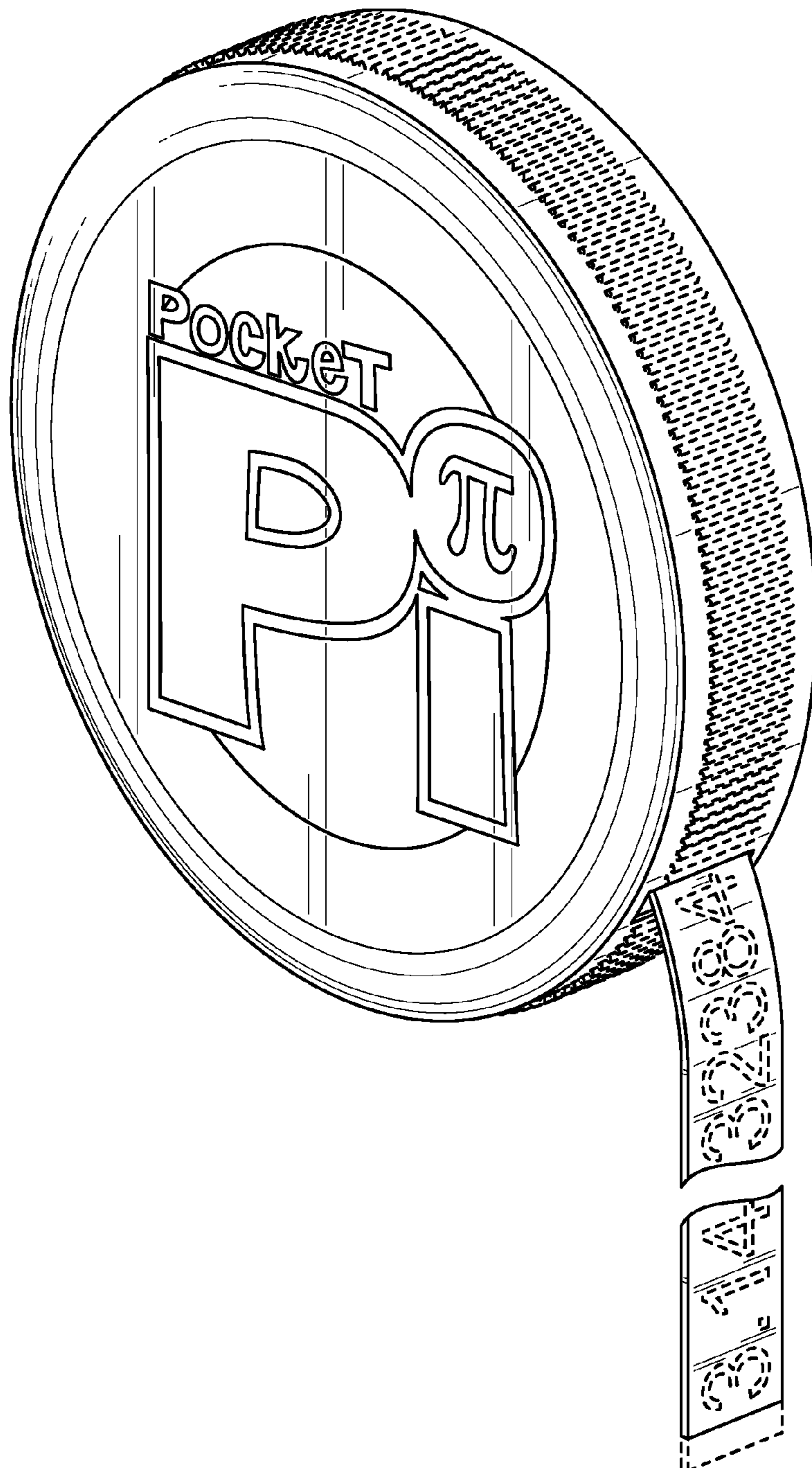

FIG. 15

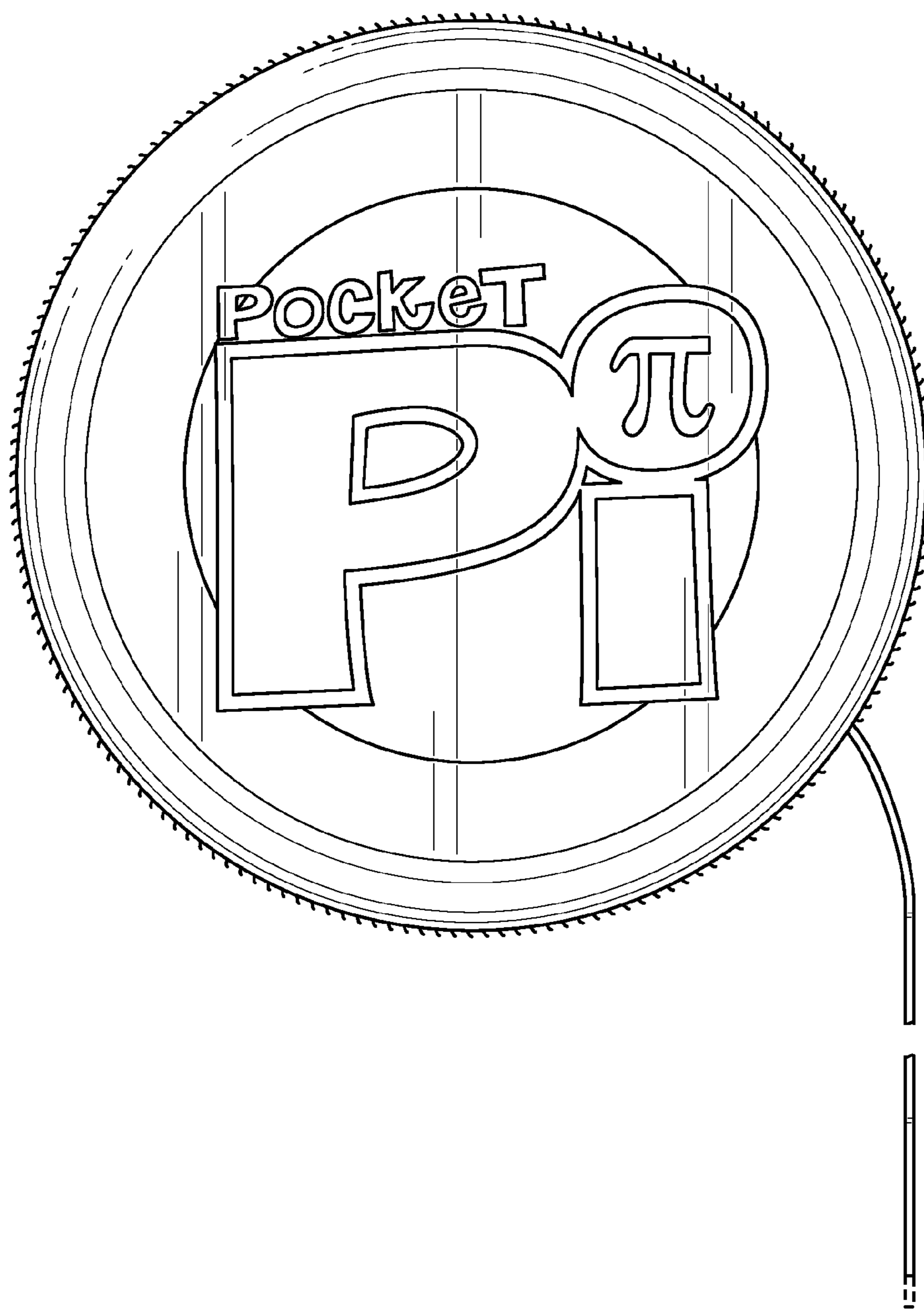

FIG. 16

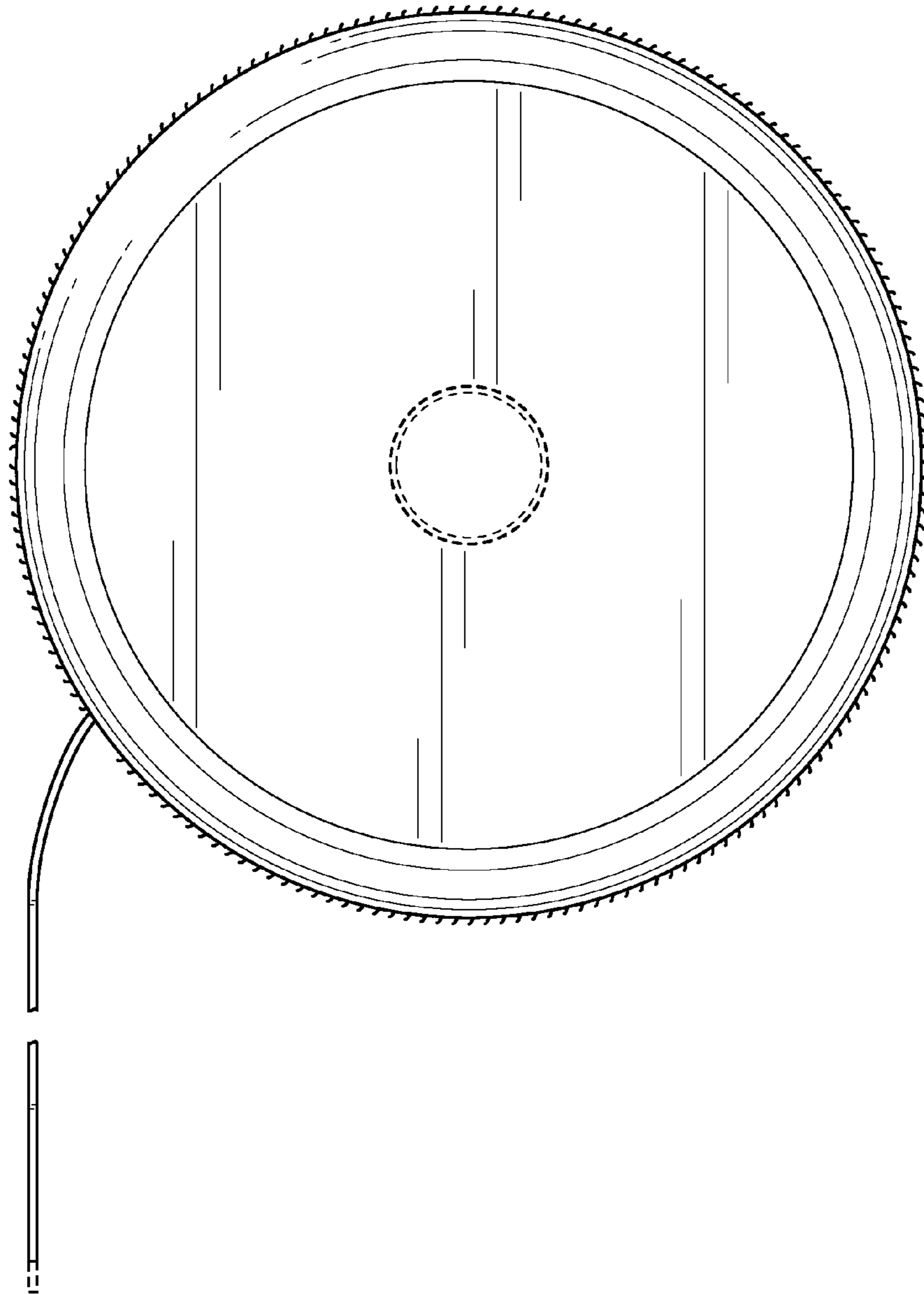

FIG. 17

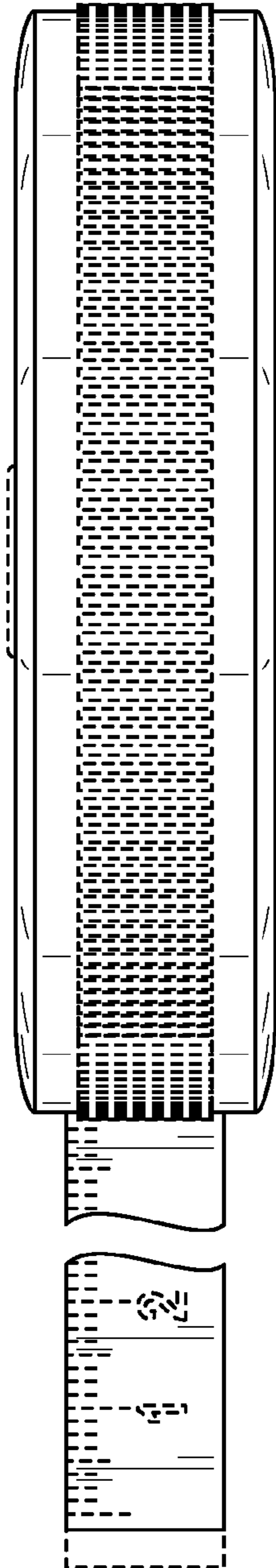

FIG. 18

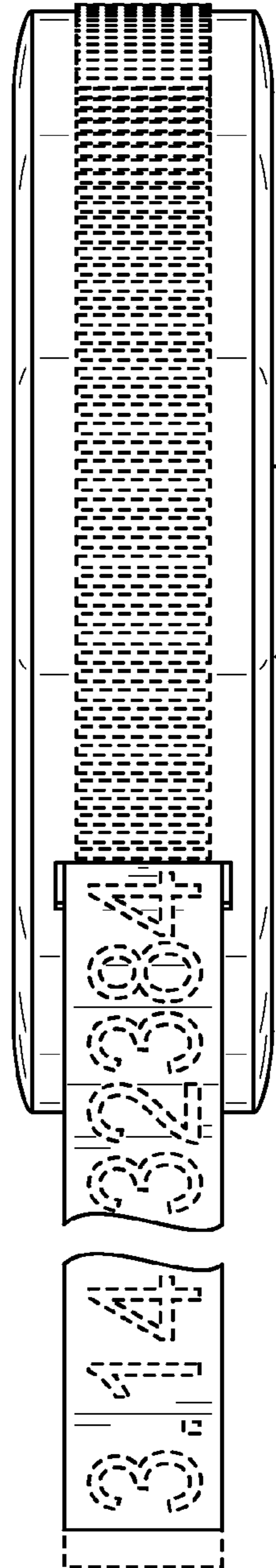

FIG. 19

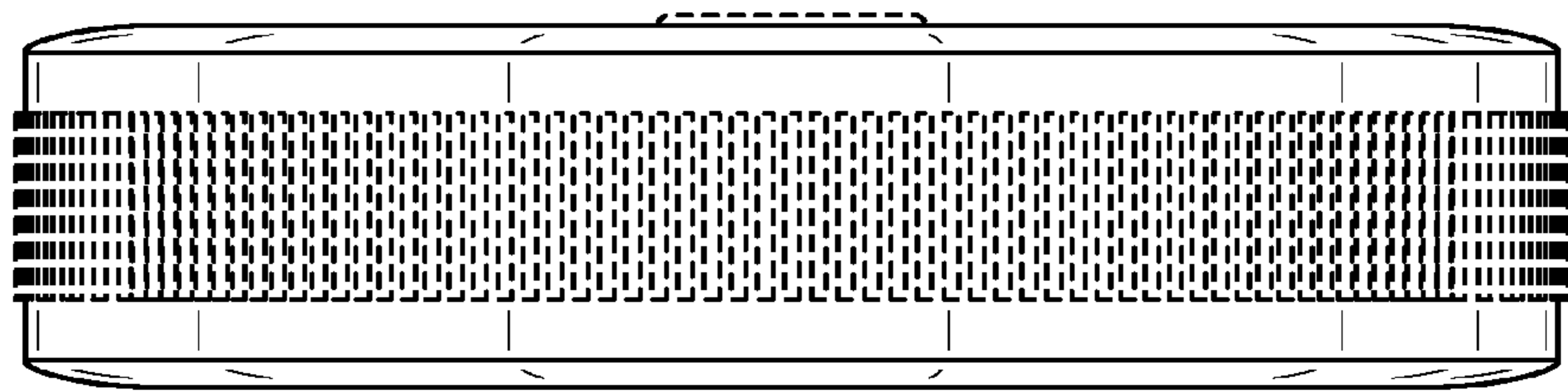

FIG. 20

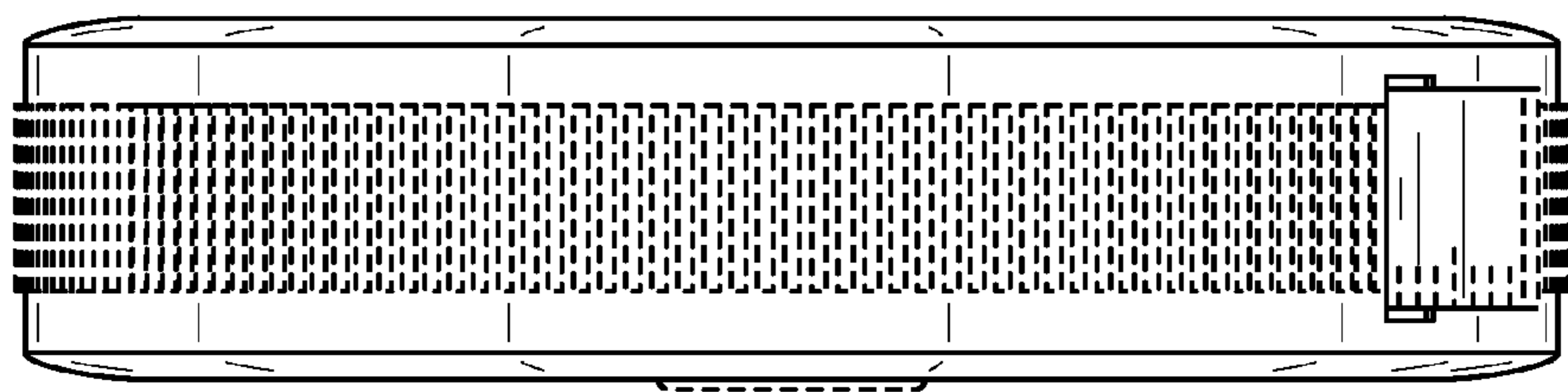

FIG. 21

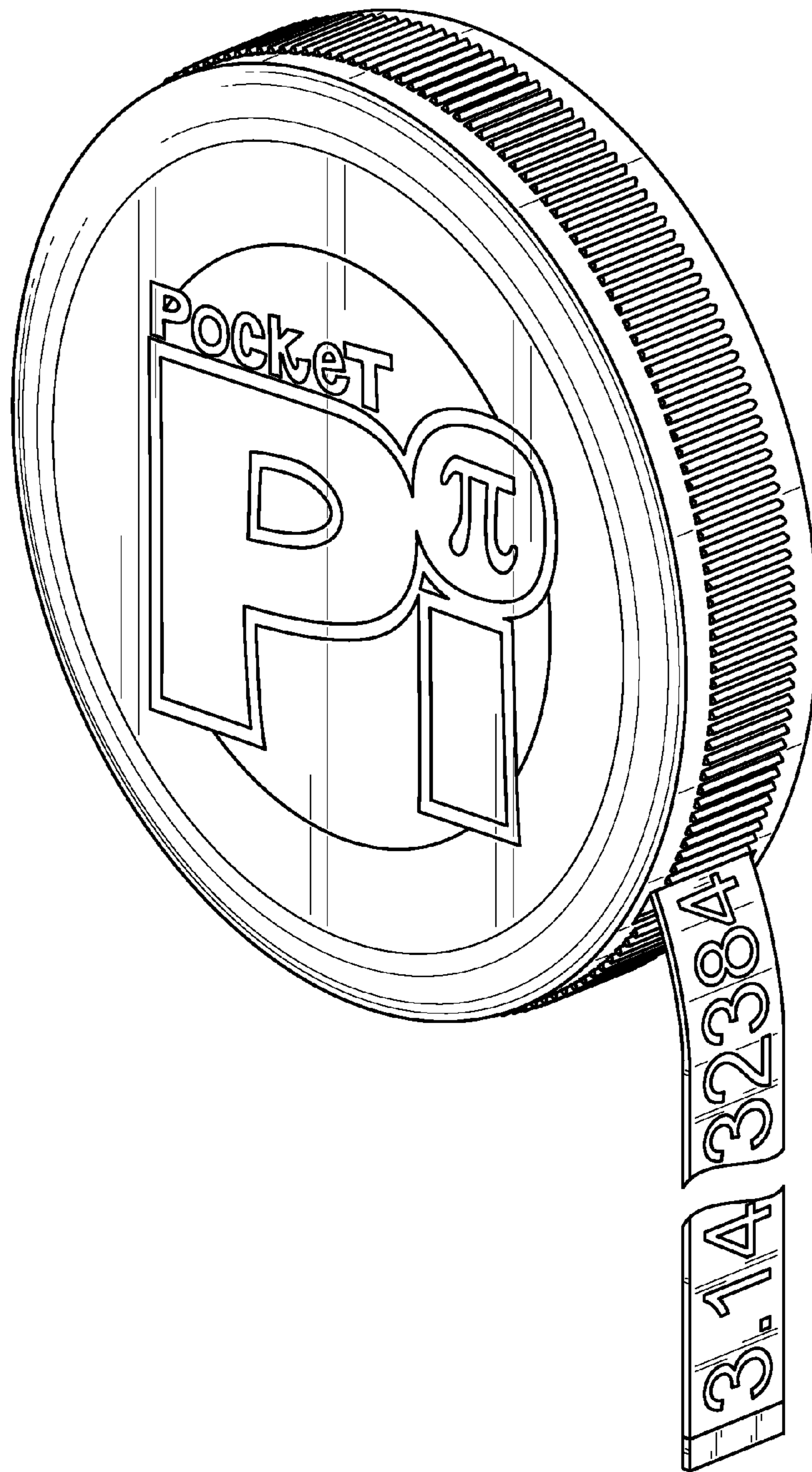

FIG. 22

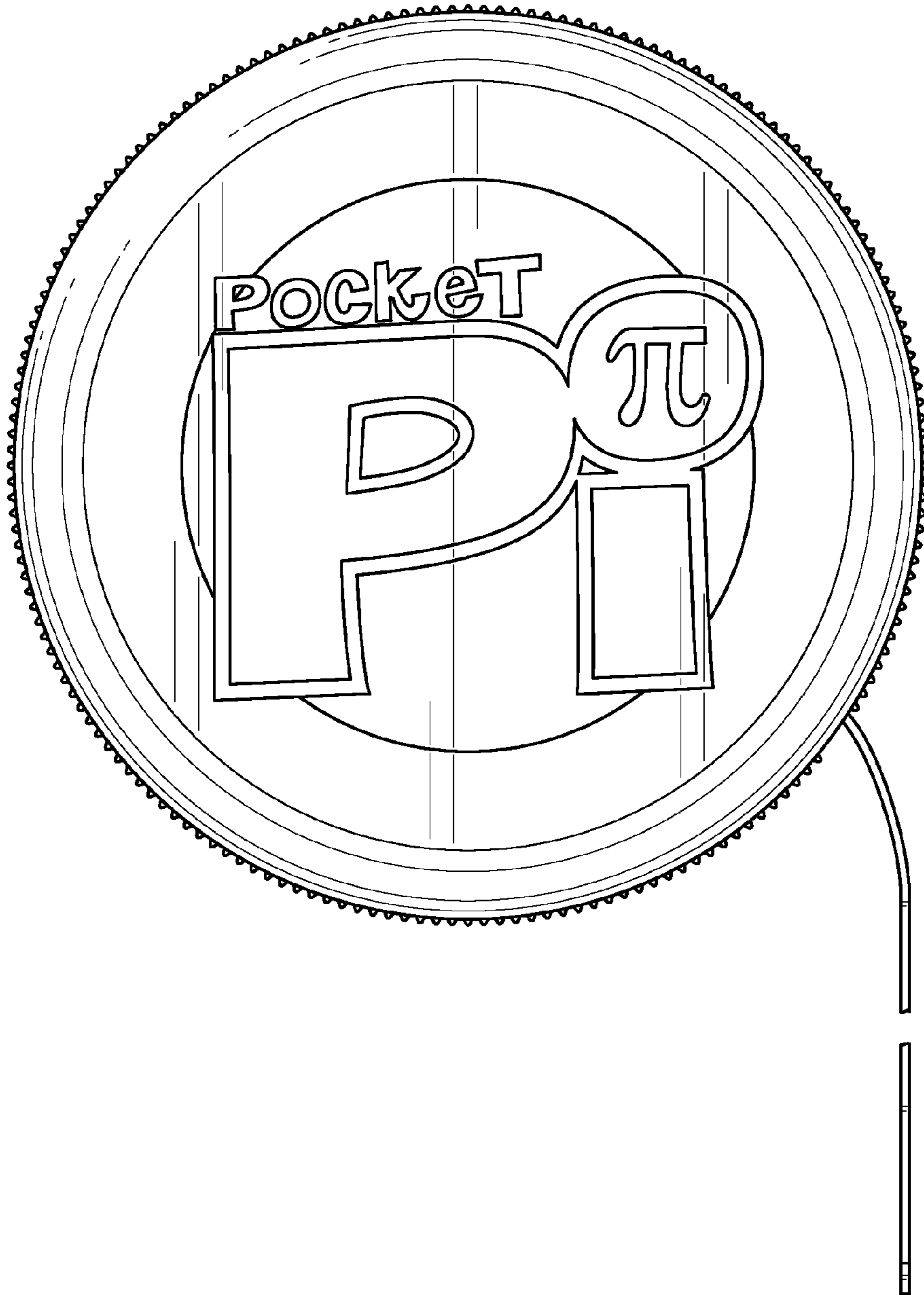

FIG. 23

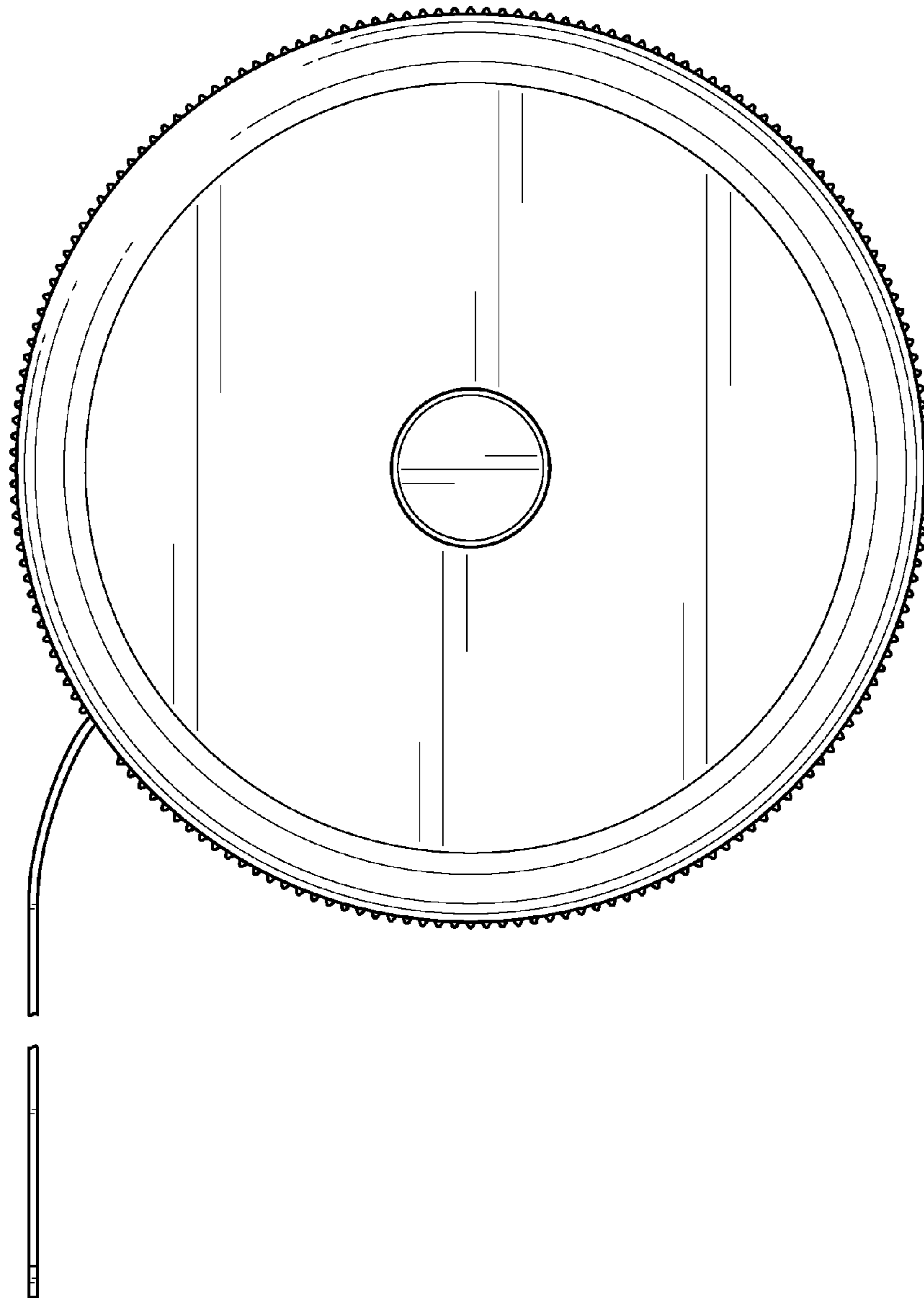

FIG. 24

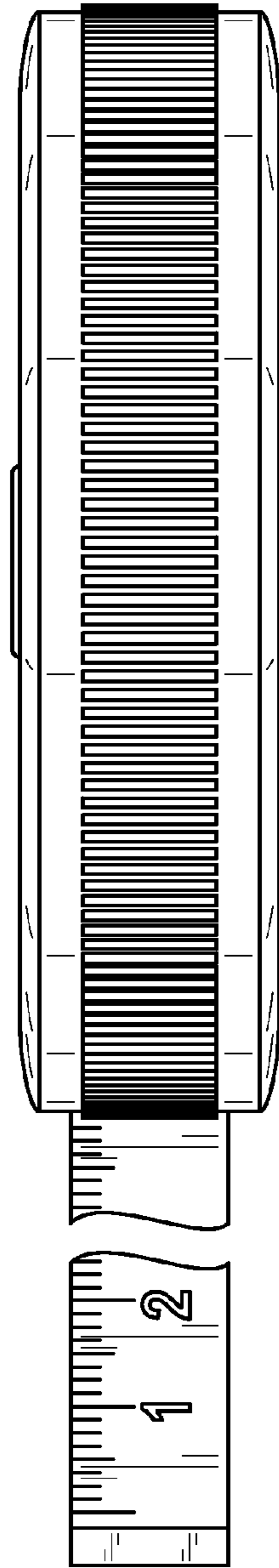

FIG. 25

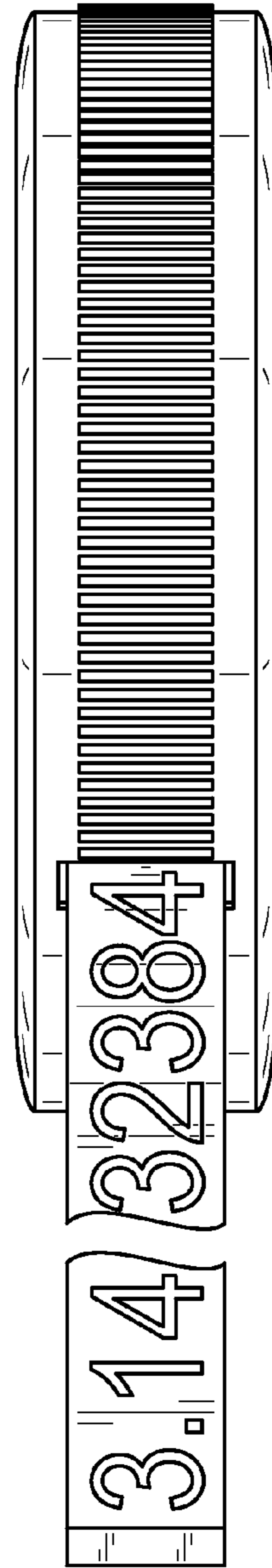

FIG. 26

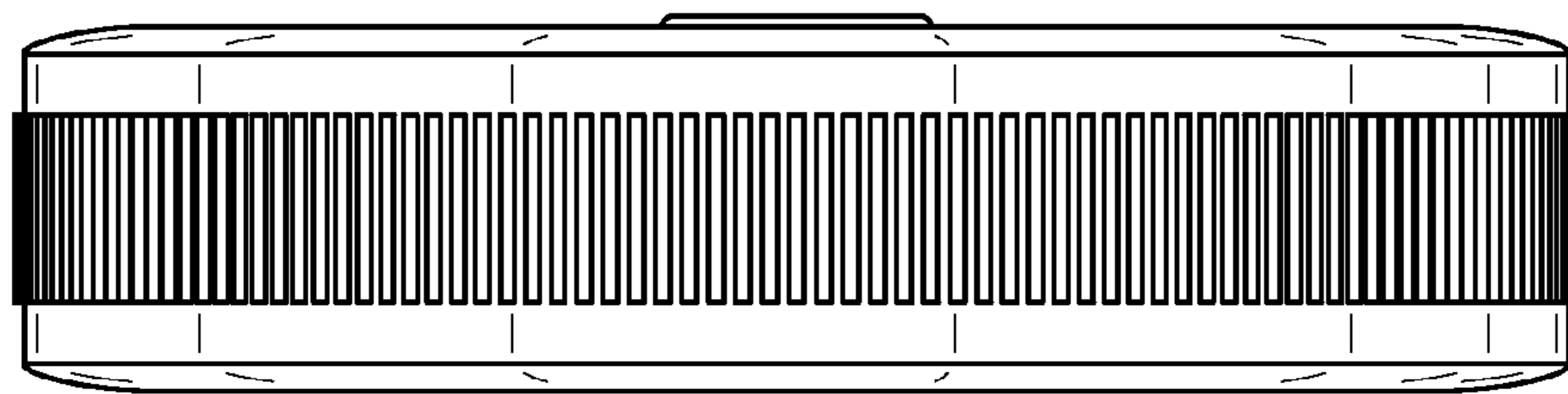

FIG. 27

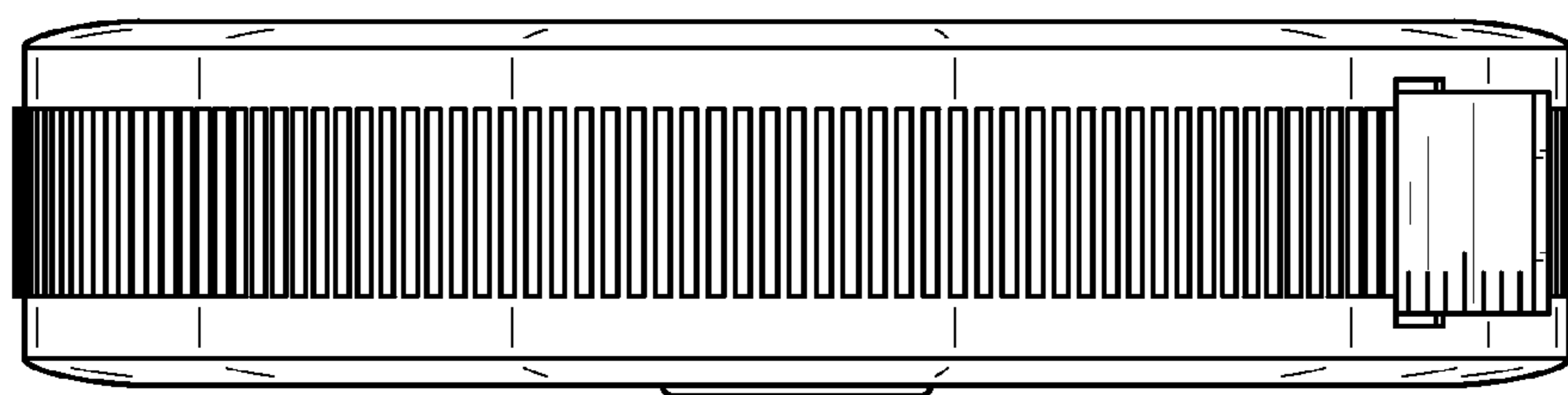

FIG. 28