



US00D731307S

(12) **United States Design Patent**  
**Short et al.**

(10) **Patent No.:** **US D731,307 S**  
(45) **Date of Patent:** **\*\* Jun. 9, 2015**

(54) **PACKAGING**

(71) Applicant: **Tweezerman**, Port Washington, NY  
(US)

(72) Inventors: **Martin Short**, Jersey City, NJ (US);  
**Stéphane Krumenacker**, Wynnwood,  
PA (US); **Brian KyungMoo Kang**, West  
New York, NJ (US)

(73) Assignee: **Tweezerman International, LLC**, Port  
Washington, NY (US)

(\*\*) Term: **14 Years**

(21) Appl. No.: **29/448,737**

(22) Filed: **Mar. 13, 2013**

(51) **LOC (10) Cl.** ..... **09-03**

(52) **U.S. Cl.**  
USPC ..... **D9/430**

(58) **Field of Classification Search**  
USPC ..... D9/414-433, 444-445, 456, 711, 715,  
D9/718, 748; D7/601, 602, 538, 540,  
D7/550.1; D3/203.5, 202, 207, 210;  
D4/116  
CPC ..... B65D 5/00; B65D 5/0015; B65D 5/0045;  
B65D 5/18; B65D 5/40; B65D 5/2033;  
B65D 1/22; B65D 1/225; B65D 1/24; B65D  
1/34; B65D 1/38  
See application file for complete search history.

(56) **References Cited**

**U.S. PATENT DOCUMENTS**

D219,505 S *	12/1970	Wakamatsu	.....	D9/432
D274,752 S *	7/1984	Byrne	.....	D24/223
D283,592 S *	4/1986	Quarrell et al.	.....	D6/512
D352,662 S *	11/1994	McIlvain	.....	D9/520
D472,810 S *	4/2003	Gelardi et al.	.....	D9/428
D560,491 S *	1/2008	Munford et al.	.....	D9/424
D605,035 S *	12/2009	Altonen et al.	.....	D9/432
D664,202 S *	7/2012	Shu	.....	D19/85

D669,777 S *	10/2012	Brown et al.	.....	D9/424
D679,180 S *	4/2013	Logue	.....	D9/432
D691,881 S *	10/2013	Ivey	.....	D9/424
D692,297 S *	10/2013	Wintolders et al.	.....	D9/431
D704,549 S *	5/2014	Liu	.....	D9/418

**OTHER PUBLICATIONS**

Case in Point: Tweezerman's Sharp New Look. [online] Published Mar. 1, 2013 from URL: <<http://www.brandpackaging.com/articles/84422-case-in-point-tweezermans-sharp-new-look>>.\*  
Corporate Crystal Gem. [online] Retrieved Sep. 25, 2014 from URL: <<http://www.awardsltd.com/images/p500x500/crystal-glass-awards-N4zmwm.jpg>>.\*

\* cited by examiner

*Primary Examiner* — Susan Bennett Hattan

*Assistant Examiner* — Vy Koenig

(74) *Attorney, Agent, or Firm* — Mayback & Hoffman, P.A.;  
Gregory L. Mayback

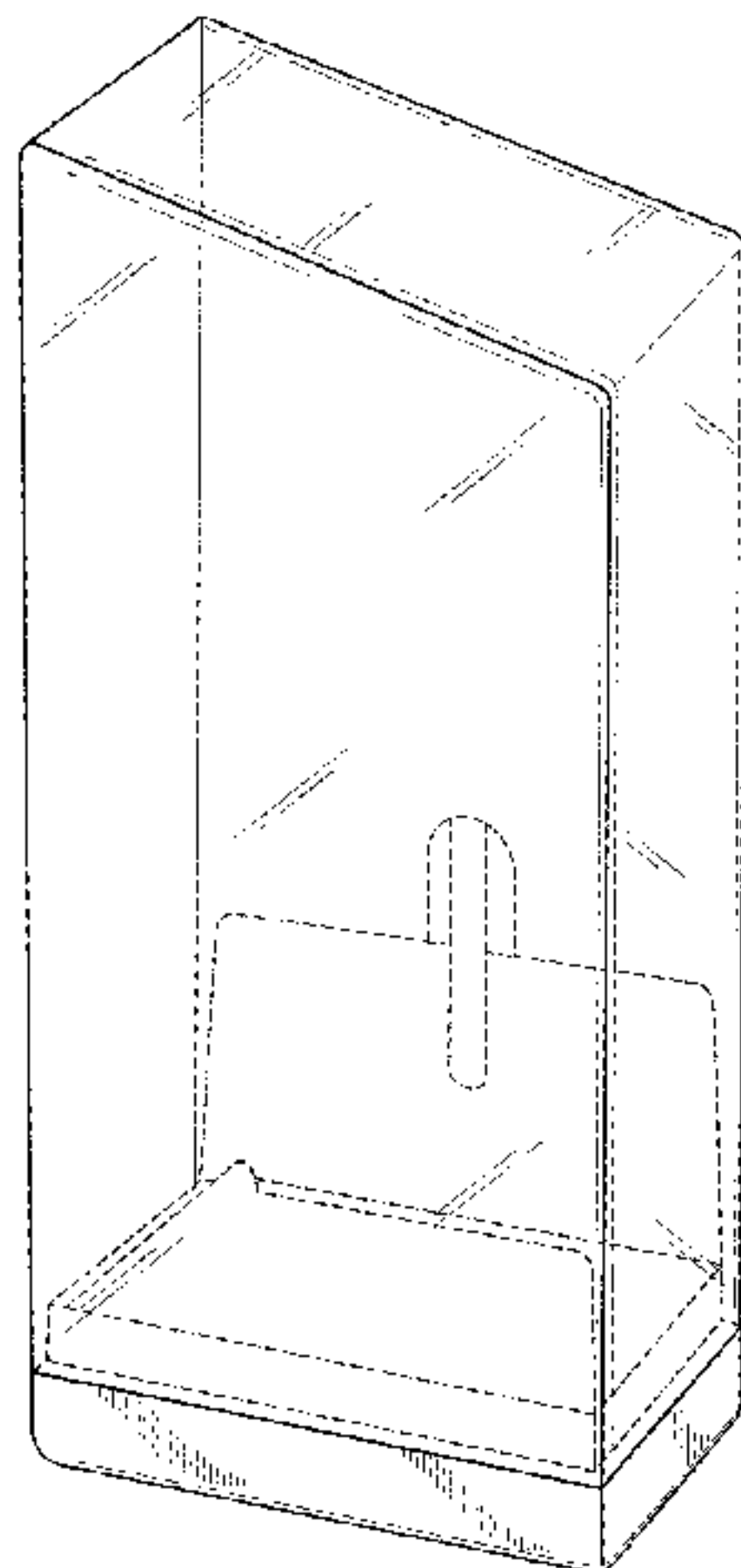
(57) **CLAIM**

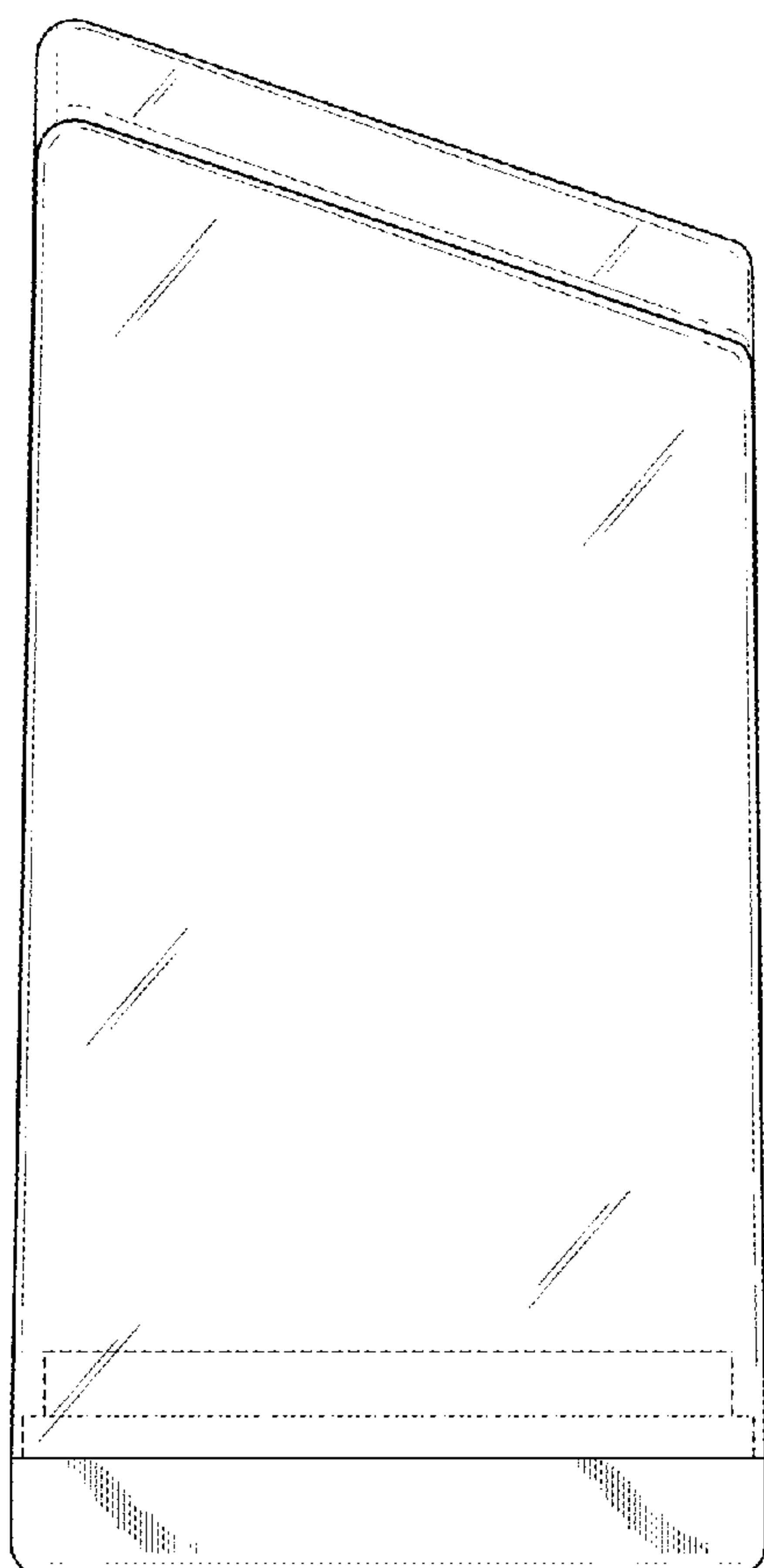
The ornamental design for packaging, as shown and described.

**DESCRIPTION**

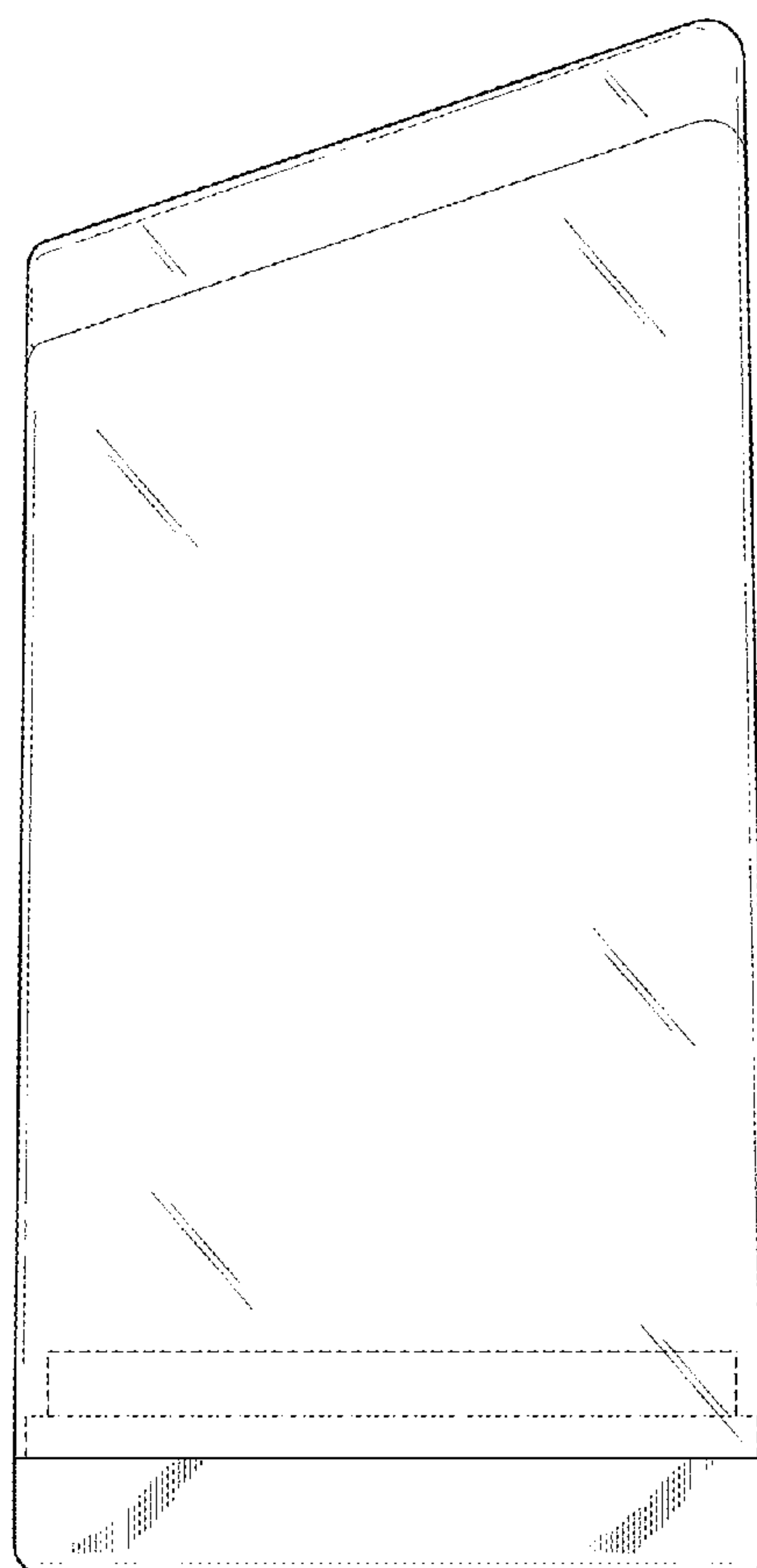
FIG. 1 is a front view of the packaging;  
FIG. 2 is a rear view thereof;  
FIG. 3 is a bottom plan view thereof;  
FIG. 4 is a left side view thereof;  
FIG. 5 is a perspective view of the packaging of FIG. 1 with an unclaimed interior bottom insert;  
FIG. 6 is a front view of the packaging of FIG. 1 with an unclaimed interior packing insert and lash curler product;  
FIG. 7 is a top plan view of the packaging of FIG. 1 in an unclaimed packaging drawer; and,  
FIG. 8 is a perspective view of the packaging of FIG. 1 in the unclaimed packaging drawer from in front of the right corner. The broken lines in the drawings depict environmental subject matter, mainly a bottom and interior packing insert, lash curler product, and a packaging drawer, and form no part of the claimed design.

**1 Claim, 5 Drawing Sheets**

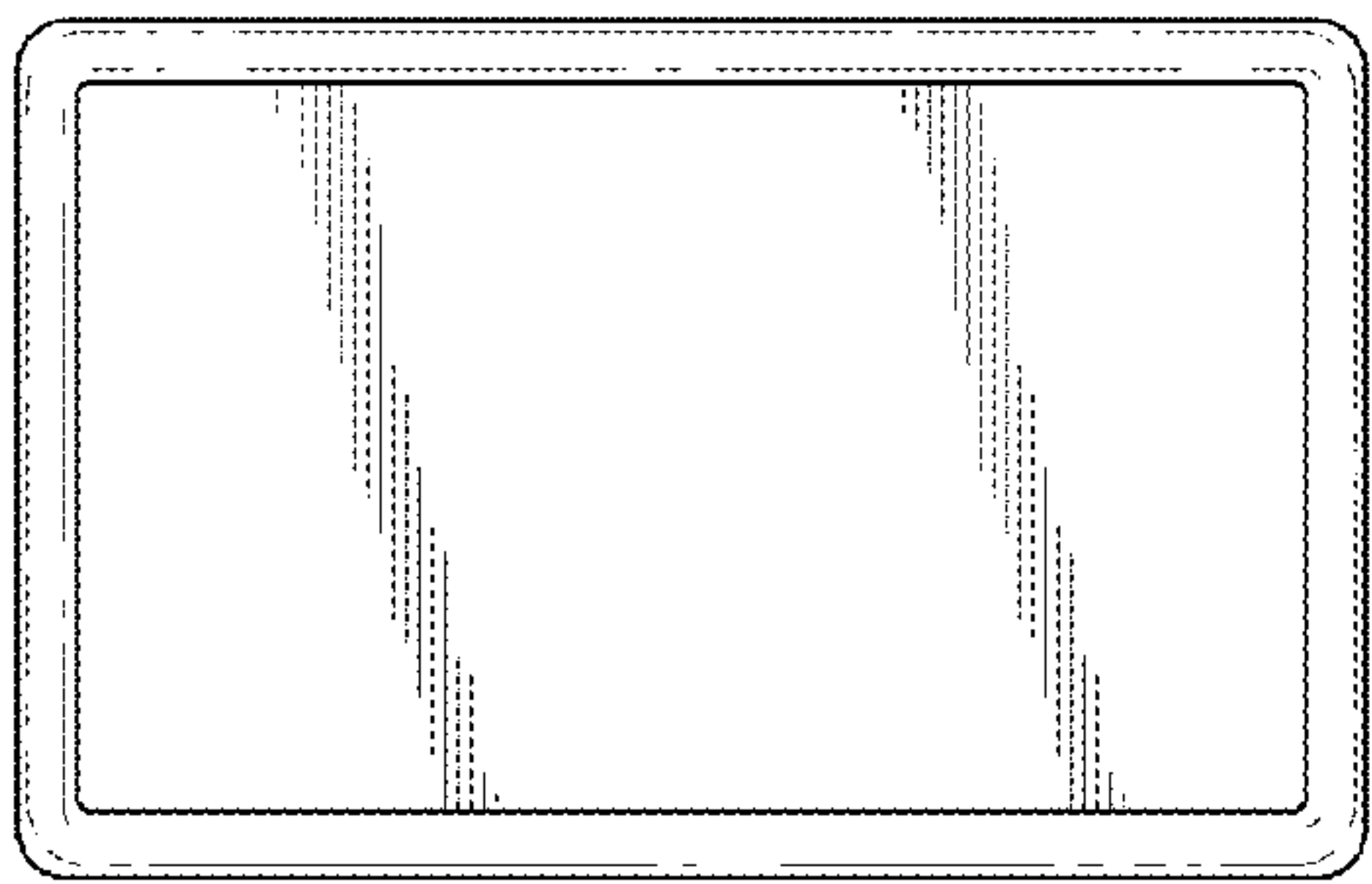




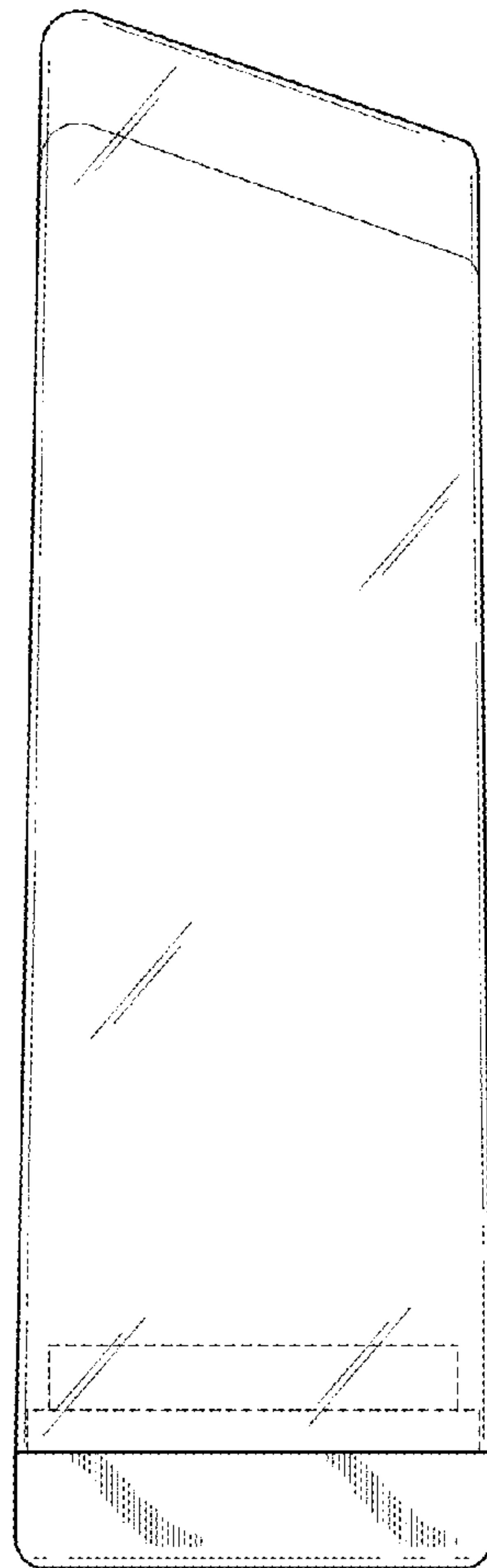
**FIG. 1**



**FIG. 2**



**FIG. 3**



**FIG. 4**

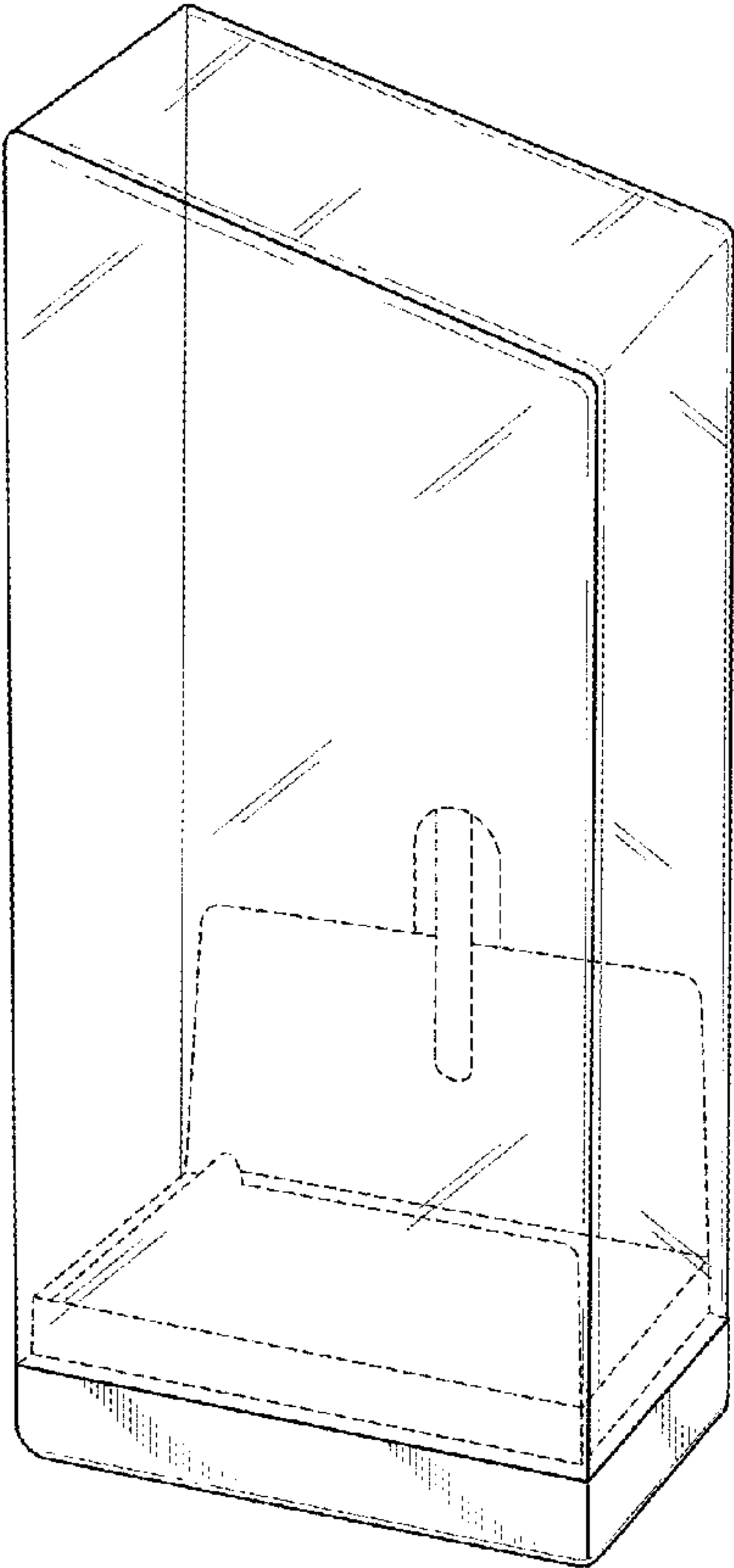


FIG. 5

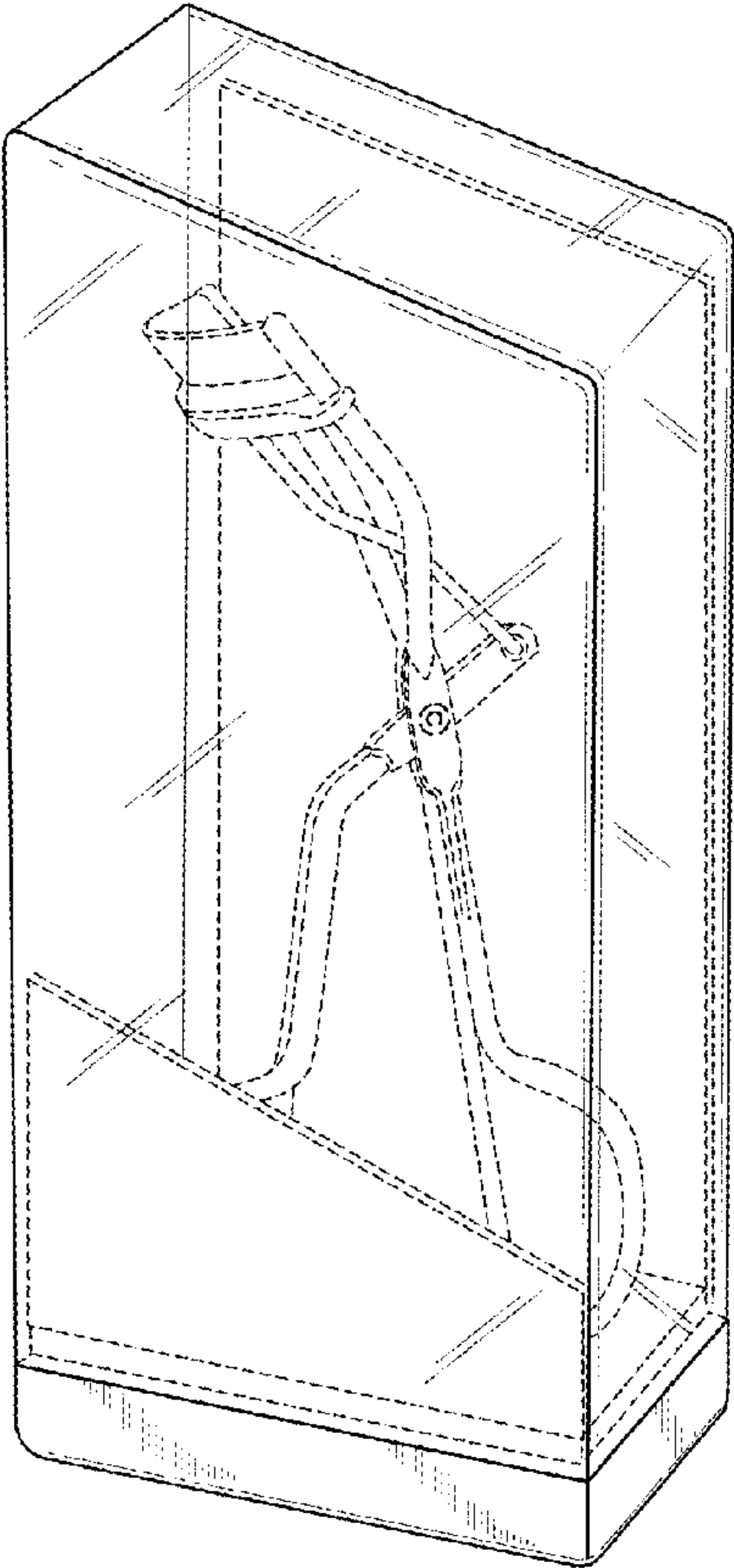
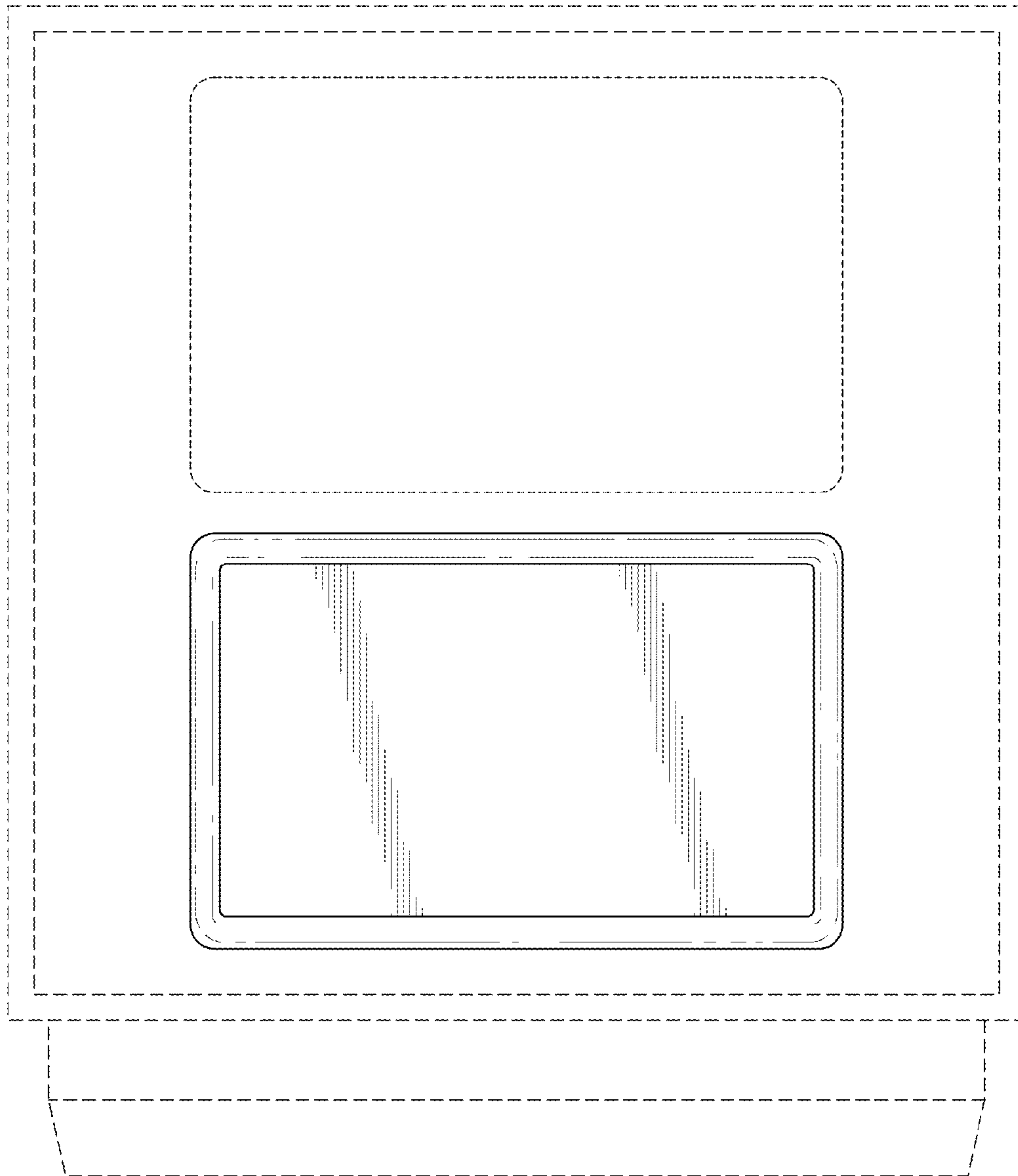
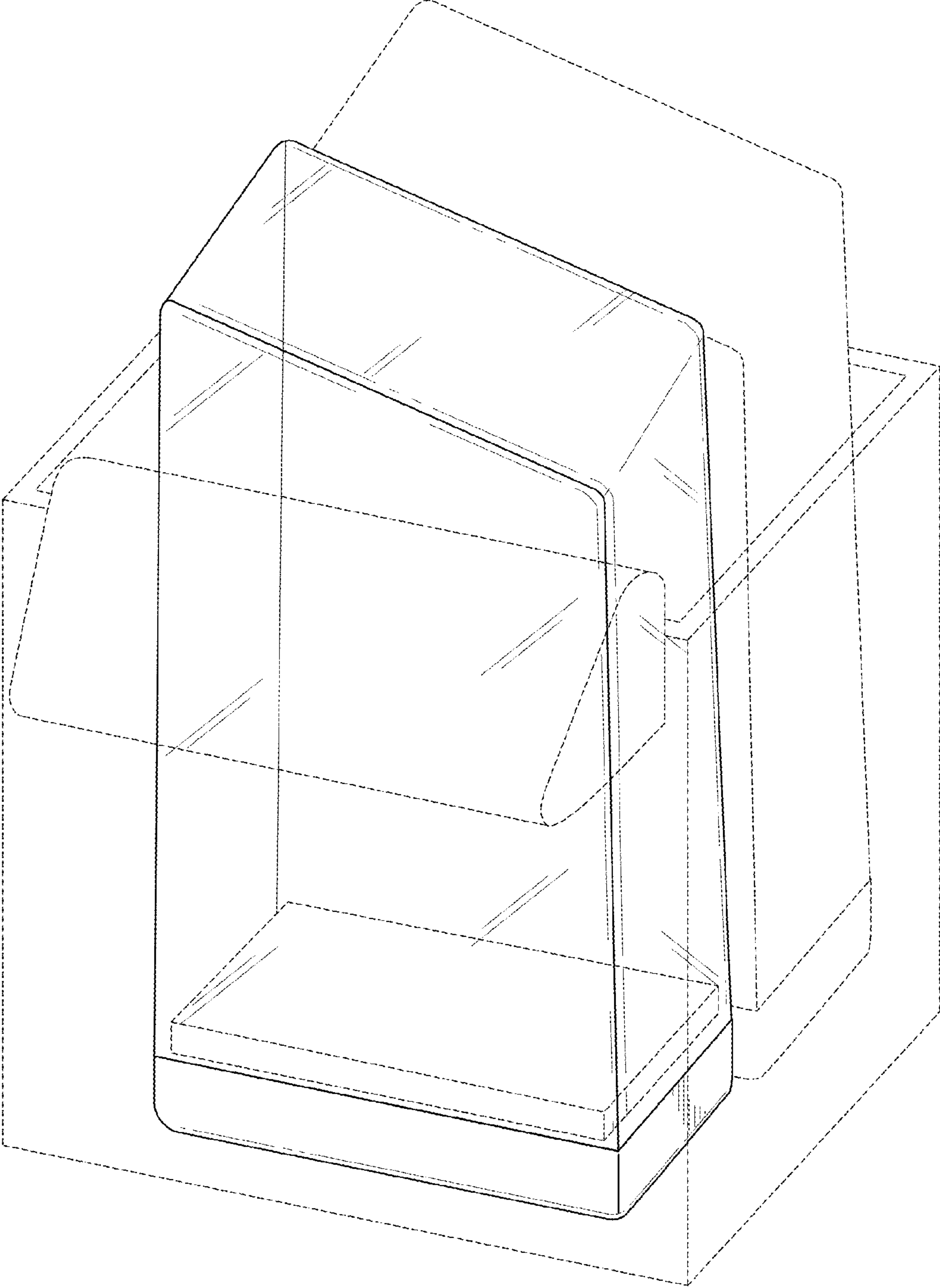


FIG. 6



**FIG. 7**





**FIG. 8**