



US00D731296S

(12) **United States Design Patent**
Nelson et al.

(10) **Patent No.:** **US D731,296 S**
(45) **Date of Patent:** **** Jun. 9, 2015**

(54) **CLIP FOR SECURING STRING OR ROPE**

(71) Applicant: **Encore Packaging LLC**, Lake Bluff, IL (US)

(72) Inventors: **Timothy H. Nelson**, Winnetka, IL (US);
Stephenson Nelson, Winnetka, IL (US)

(73) Assignee: **Encore Packaging LLC**, Lake Bluff, IL (US)

(**) Term: **14 Years**

(21) Appl. No.: **29/503,350**

(22) Filed: **Sep. 25, 2014**

(51) **LOC (10) Cl.** **08-05**

(52) **U.S. Cl.**
USPC **D8/356**

(58) **Field of Classification Search**
USPC D8/356, 354, 349; 220/575;
206/521.15; 24/302, 16 R, 306, 17 R;
439/501; 381/374; D14/217, 205
See application file for complete search history.

(56) **References Cited**

U.S. PATENT DOCUMENTS

423,312	A *	3/1890	Clark	24/134 R
1,666,623	A *	4/1928	Hoover	24/18
4,957,232	A *	9/1990	Sprague	224/674
D311,487	S *	10/1990	Platt	D8/396
5,234,185	A *	8/1993	Hoffman et al.	248/56

D353,990	S *	1/1995	Alfreds	D8/356
D390,447	S *	2/1998	Colen, Jr.	D8/356
6,092,444	A *	7/2000	Hsiao	81/440
D494,450	S *	8/2004	Schultz et al.	D8/356
6,813,981	B2 *	11/2004	Urban et al.	83/13
D613,137	S *	4/2010	Wieberdink et al.	D8/14
D624,378	S *	9/2010	Wysopal	D8/40
D627,632	S *	11/2010	Elmer et al.	D8/383
D660,740	S *	5/2012	Cullen et al.	D11/3
D662,087	S *	6/2012	Peller	D14/223
D675,123	S *	1/2013	Nunez	D11/3
D684,845	S *	6/2013	Wood	D8/356
8,615,849	B2 *	12/2013	Rothbaum et al.	24/16 R
D702,109	S *	4/2014	Weinberg	D8/356

* cited by examiner

Primary Examiner — Cynthia Underwood

(74) *Attorney, Agent, or Firm* — Fitch, Even, Tabin & Flannery LLP

(57) **CLAIM**

We claim the ornamental design for a clip for securing string or rope, as shown and described.

DESCRIPTION

FIG. 1 is a front perspective view of a clip;
FIG. 2 is a rear perspective view of the clip of FIG. 1;
FIG. 3 is a front plan view of the clip of FIG. 1;
FIG. 4 is a bottom plan view of the clip of FIG. 1;
FIG. 5 is a right side plan view of the clip of FIG. 1;
FIG. 6 is a left side plan view of the clip of FIG. 1;
FIG. 7 is a top end side plan view of the clip of FIG. 1; and,
FIG. 8 is a bottom end side plan view of the clip of FIG. 1.

1 Claim, 3 Drawing Sheets

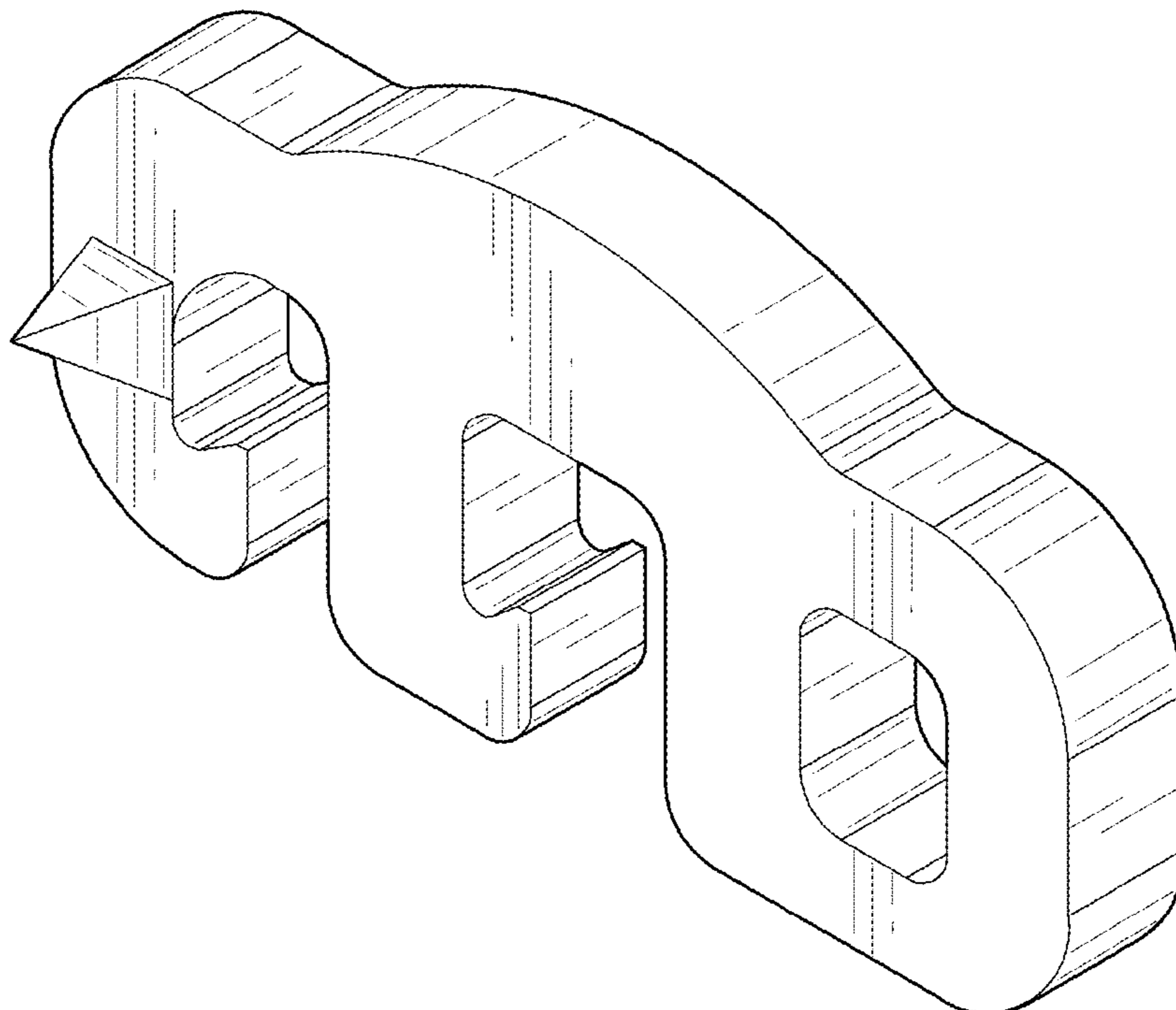

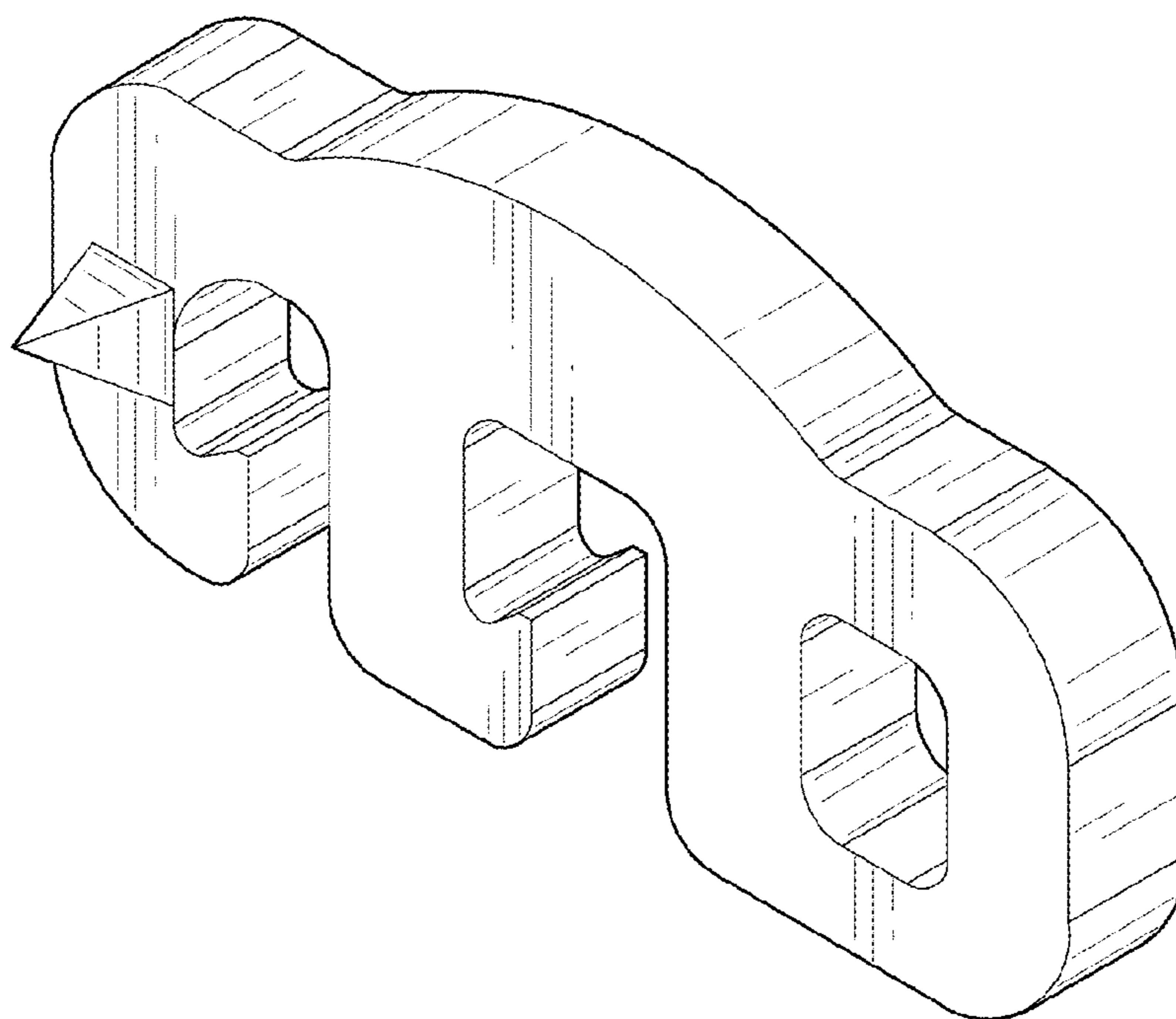

FIG. 1

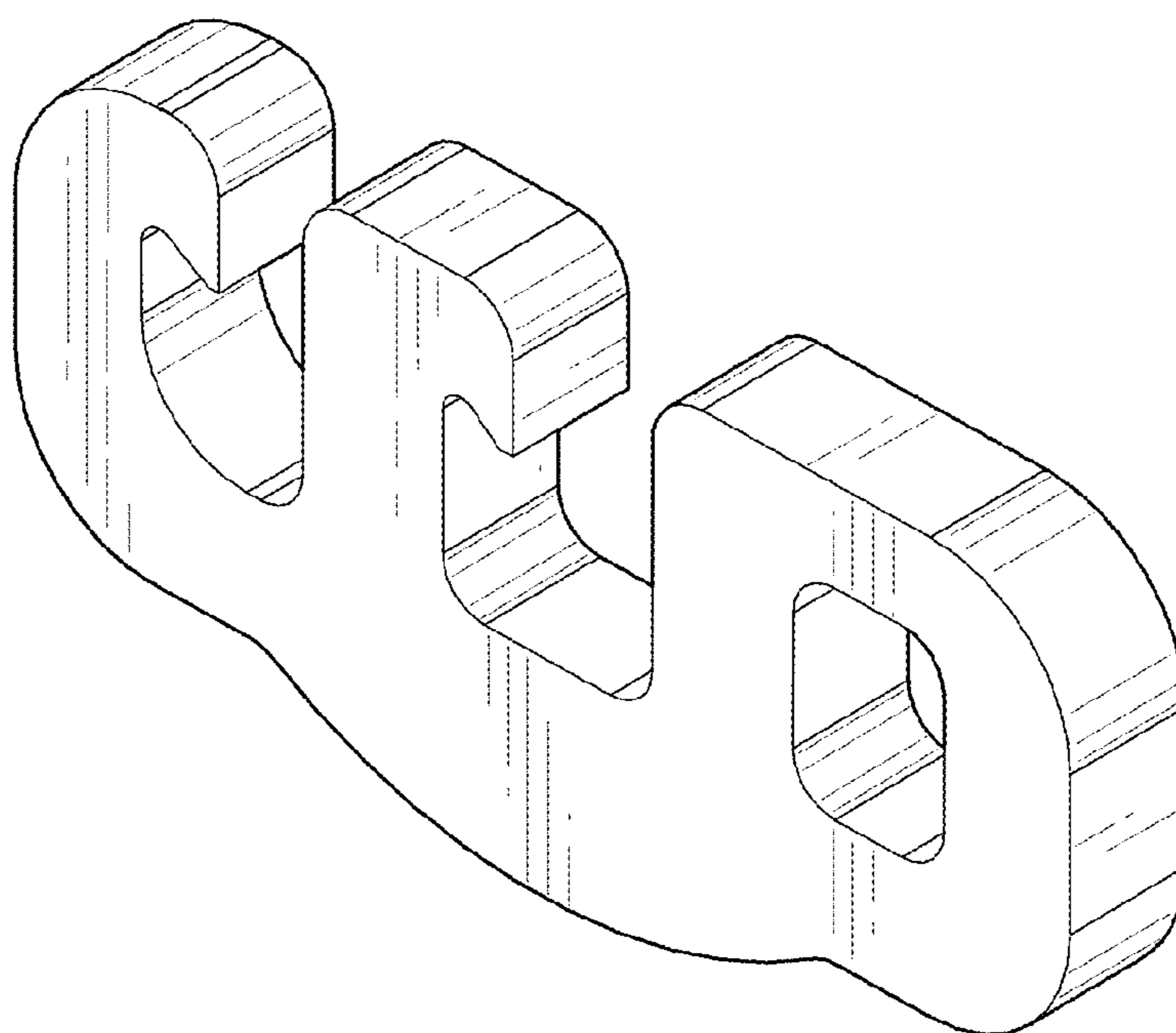

FIG. 2

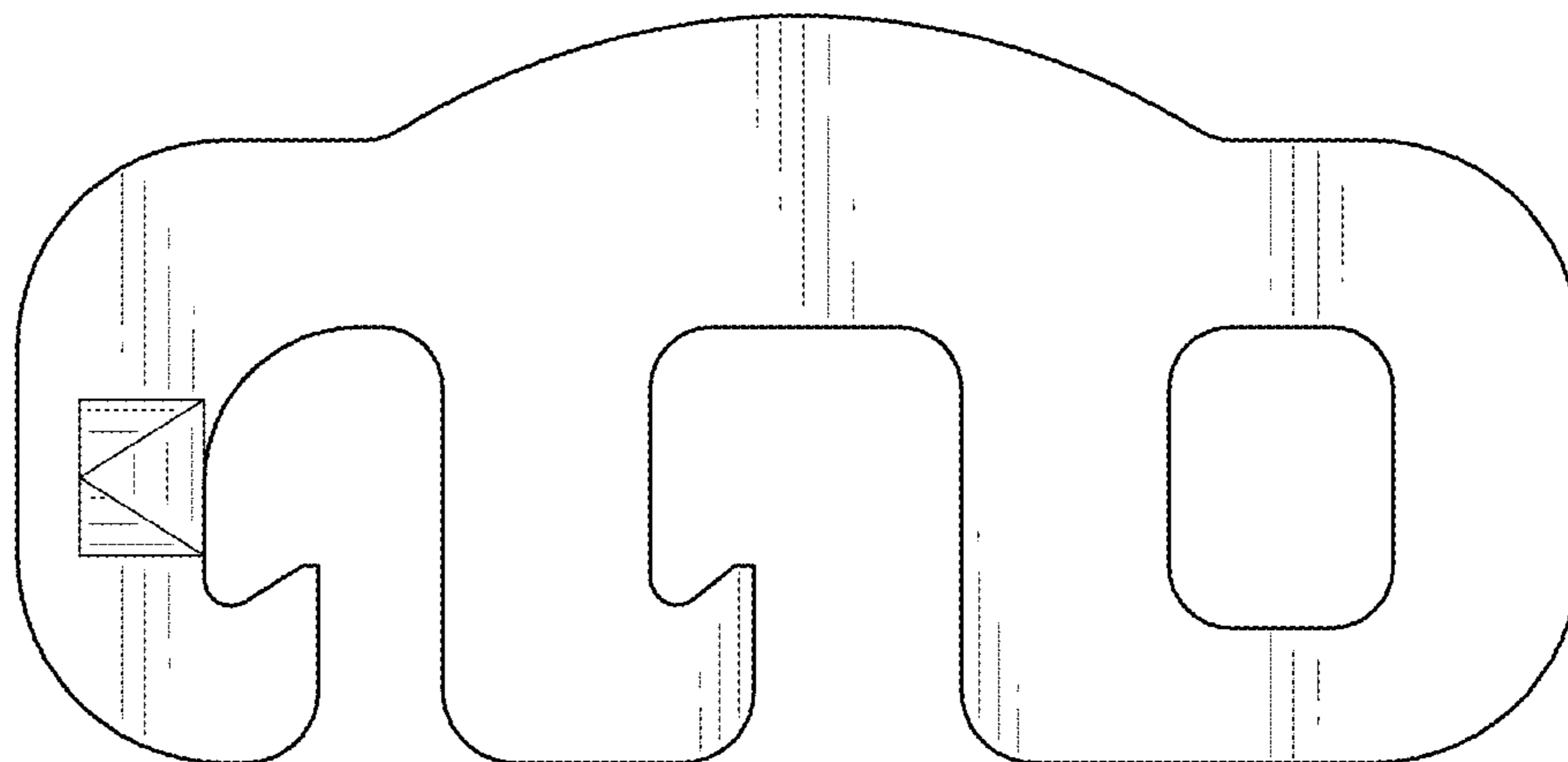

FIG. 3

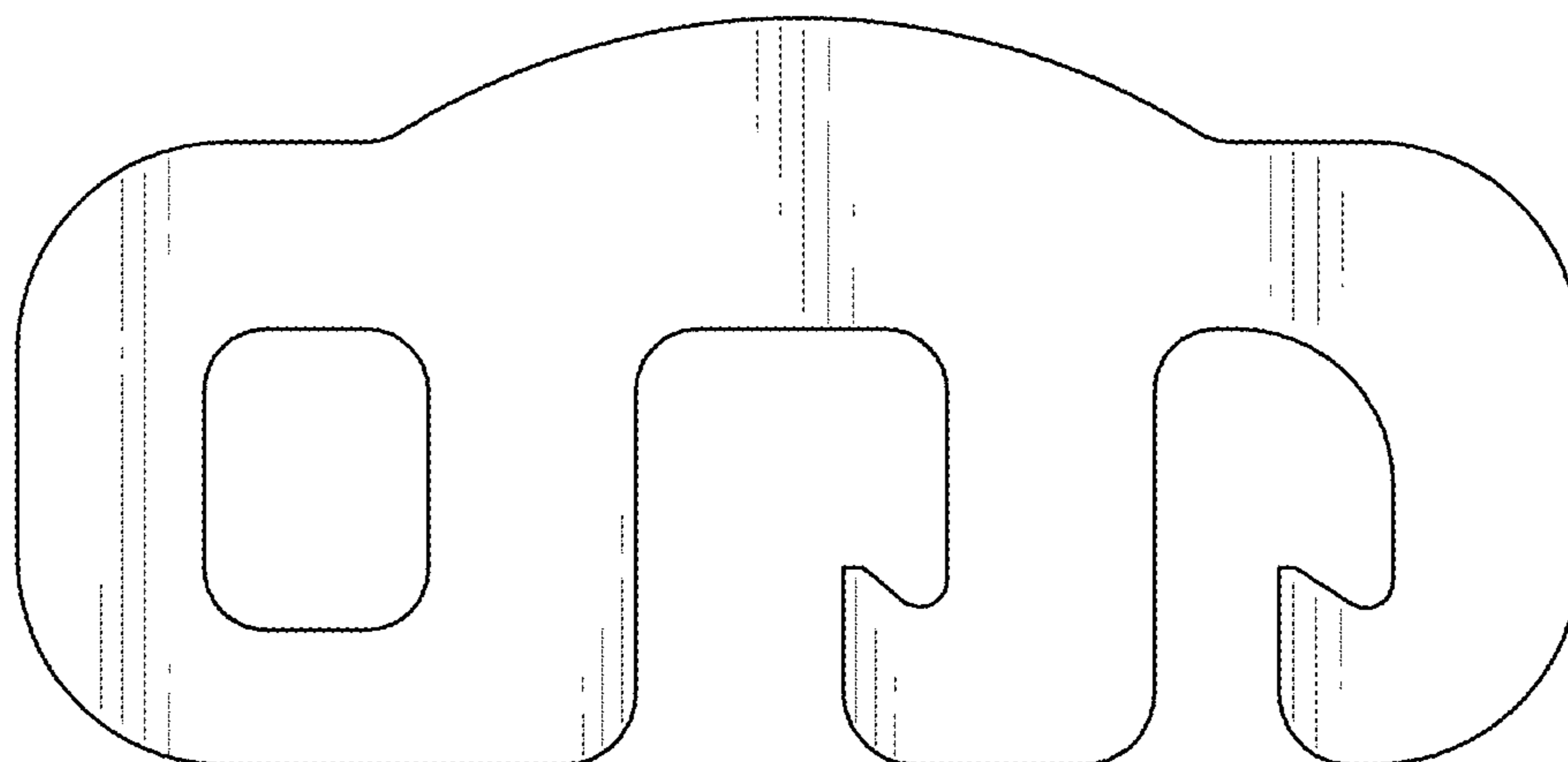

FIG. 4

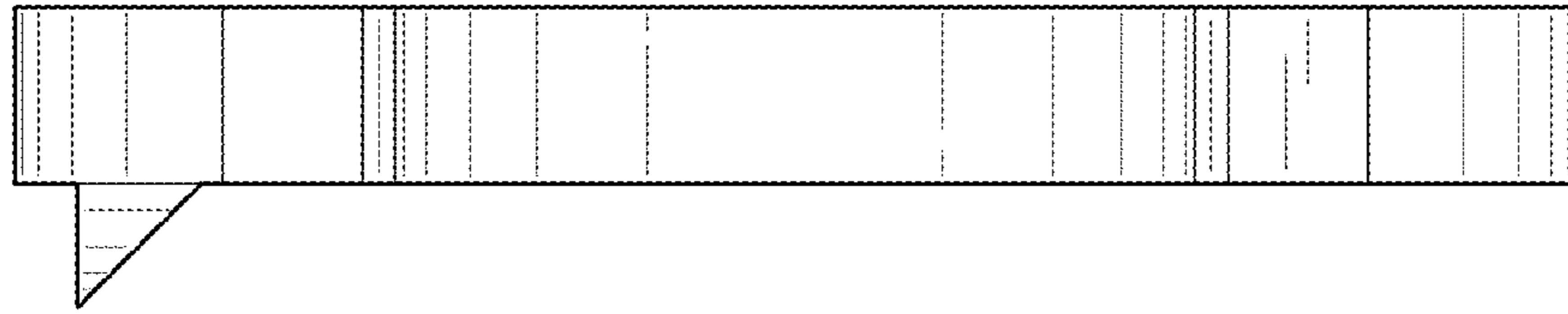

FIG. 5

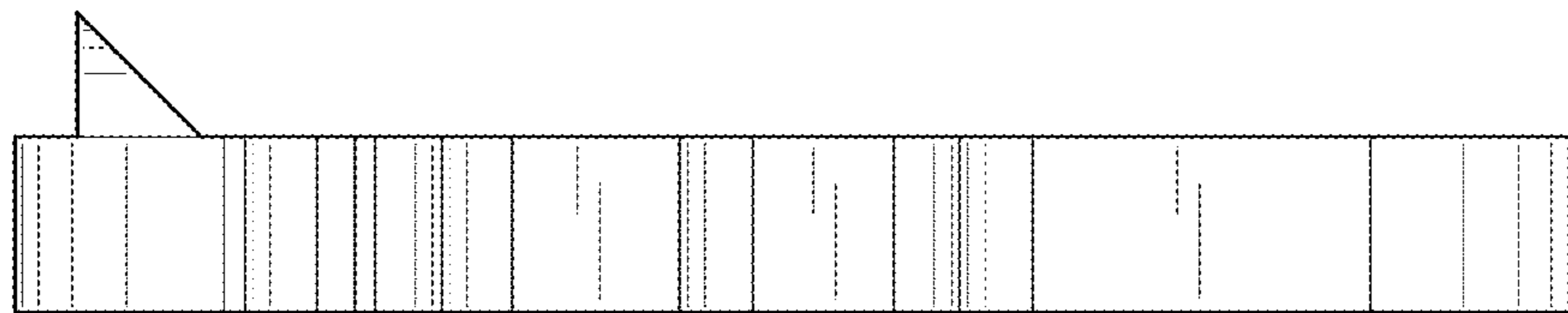

FIG. 6

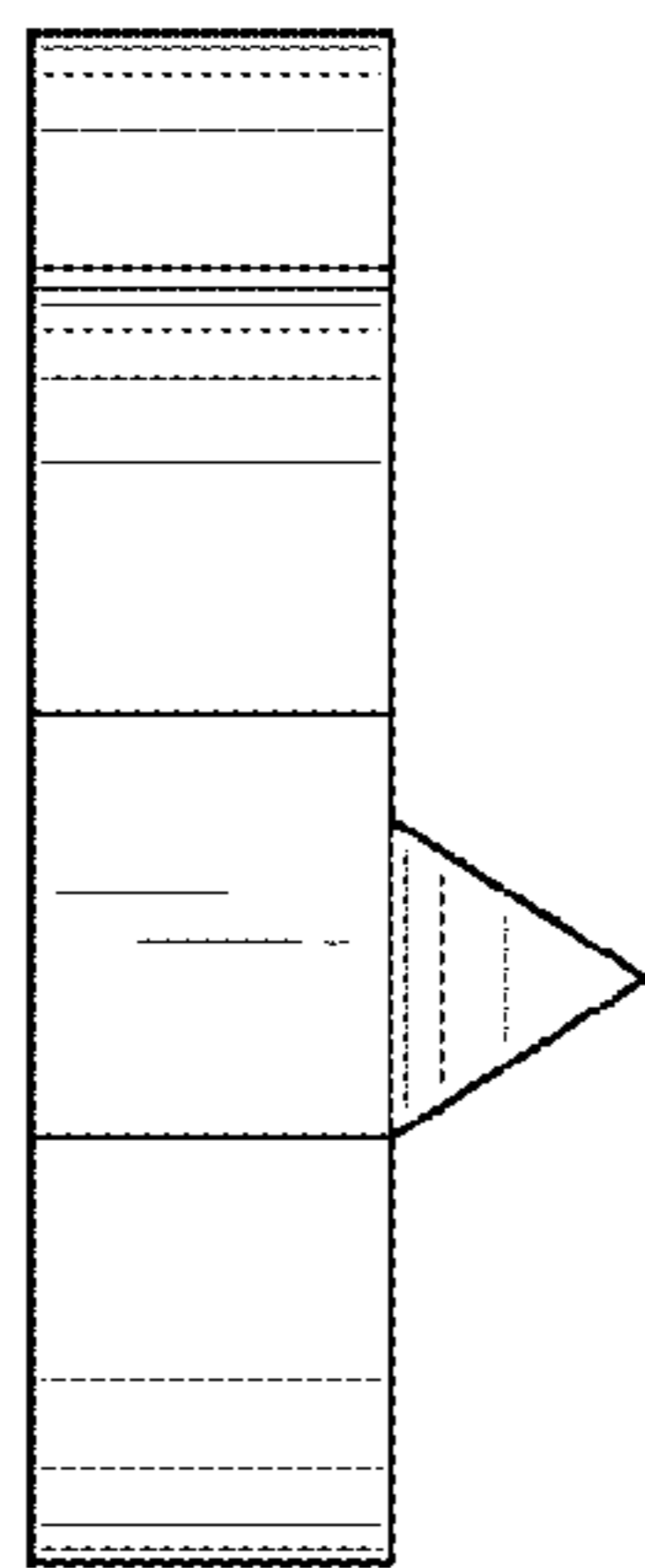

FIG. 7

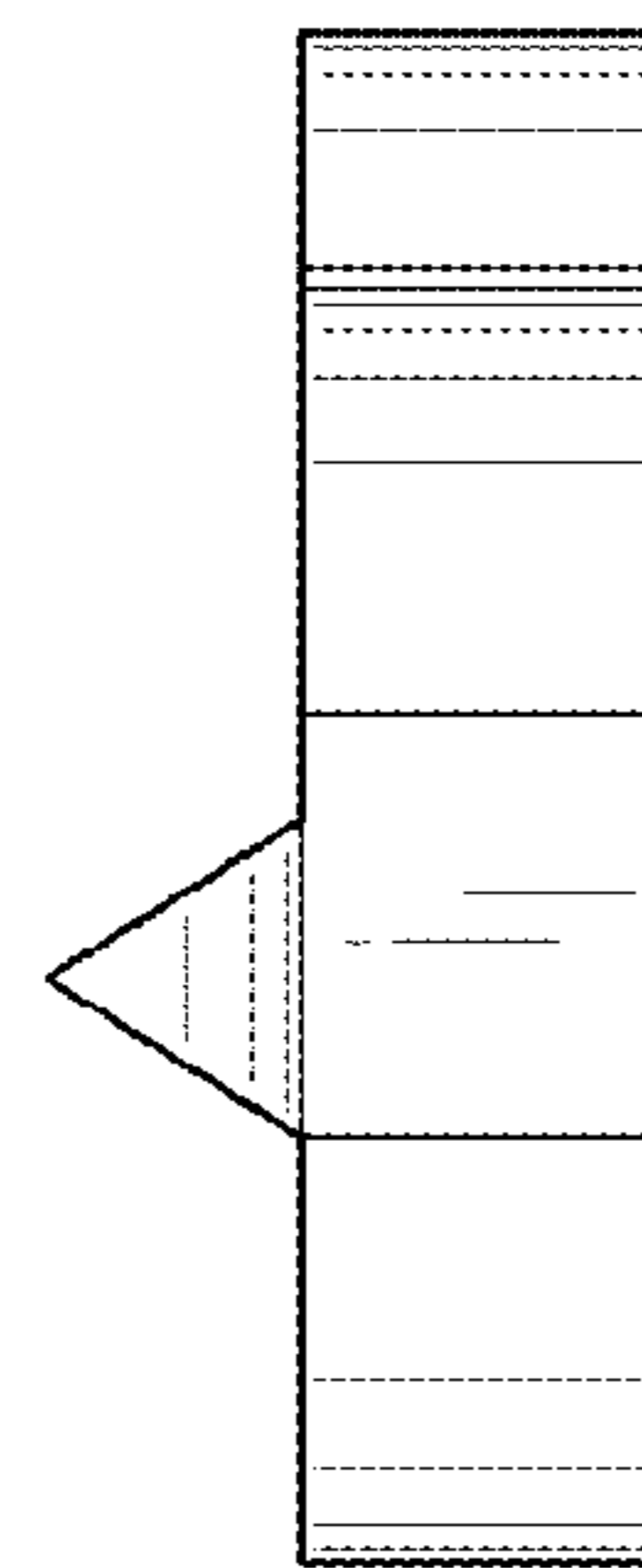

FIG. 8