



US00D731242S

(12) **United States Design Patent**
Machovina et al.

(10) **Patent No.:** **US D731,242 S**
(45) **Date of Patent:** **** Jun. 9, 2015**

(54) **SUPPLY ASSEMBLY FOR A FOOD
HOMOGENIZER**

B02C 1/08; B02C 2/04; B02C 4/42; B02C
4/142; B02C 4/143; B02C 4/423; B02C
13/1835; B28C 5/10; B28C 5/12; B28C 5/14;
B28C 5/16; B65D 1/265; B67D 7/02
See application file for complete search history.

(71) Applicant: **HEALTHY FOODS, LLC**, Cleveland,
OH (US)

(72) Inventors: **Brian Louis Machovina**, Coral Gables,
FL (US); **Robert Johnson**, Montville,
OH (US); **Robert Schmidt**, Painesville,
OH (US); **Winston Breeden, III**,
Chagrin Falls, OH (US); **Douglas
Edward Whitner**, Chagrin Falls, OH
(US); **Ryan Scott Crisp**, Lewis Center,
OH (US); **Eileen McHale**, Coral Gables,
FL (US)

(56) **References Cited**

U.S. PATENT DOCUMENTS

933,444	A *	9/1909	Henke, Jr.	220/506
5,720,416	A *	2/1998	Izoe	222/138
8,146,490	B2 *	4/2012	Obersteiner et al.	99/510
D677,975	S *	3/2013	Jin et al.	D7/381
D682,606	S *	5/2013	Machovina et al.	D7/377
D701,077	S *	3/2014	Whitner et al.	D7/377
D703,995	S *	5/2014	Bock	D7/386
8,973,855	B2 *	3/2015	Machovina et al.	241/261.1
2007/0089613	A1 *	4/2007	Wu Chang	99/495
2007/0107609	A1 *	5/2007	Barker et al.	99/509
2012/0048977	A1 *	3/2012	Machovina et al.	241/277
2014/0061342	A1 *	3/2014	Machovina et al.	241/64
2014/0061345	A1 *	3/2014	Machovina et al.	241/100

(73) Assignee: **HEALTHY FOODS, LLC**, Cleveland,
OH (US)

(**) Term: **14 Years**

(21) Appl. No.: **29/472,249**

(22) Filed: **Nov. 11, 2013**

(51) **LOC (10) Cl.** **31-00**

(52) **U.S. Cl.**
USPC **D7/412; D7/377**

(58) **Field of Classification Search**
USPC D7/372, 376-386, 412-413, 602, 629,
D7/665-666, 669, 679, 693-694; 99/495,
99/509-511; 220/506; 222/138; 241/64,
241/92, 98, 100, 101.01-101.2, 166-169.1,
241/261.1, 274-278.2, 285.1-285.3, 291,
241/292.1; 366/64-65, 97-98, 100, 130,
366/197-201, 205-207, 219-220, 341-343
CPC A21C 1/02; A21C 1/04; A23N 1/00;
A23N 1/02; A47J 19/027; A47J 43/04;
A47J 43/25; A47J 43/27; A47J 43/042;
A47J 43/044; A47J 43/046; A47J 43/07;
A47J 43/075; A47J 43/0716; A47J 43/0722;
A47J 43/0727; B01F 3/00; B01F 3/0807;
B01F 3/0853; B01F 13/0059; B01F 13/0064;

* cited by examiner

Primary Examiner — Ricky Pham

(74) *Attorney, Agent, or Firm* — Cooper Legal Group, LLC

(57) **CLAIM**

The ornamental design for a supply assembly for a food homogenizer, as shown and described.

DESCRIPTION

FIG. 1 is a first perspective view of a supply assembly for a food based homogenizer, showing the new design.
FIG. 2 is a front-side view thereof.
FIG. 3 is a top-side view thereof.
FIG. 4 is a bottom-side view thereof.
FIG. 5 is an exploded view thereof; and,
FIG. 6 is a second perspective view of a bottom-side of the supply assembly.

1 Claim, 6 Drawing Sheets

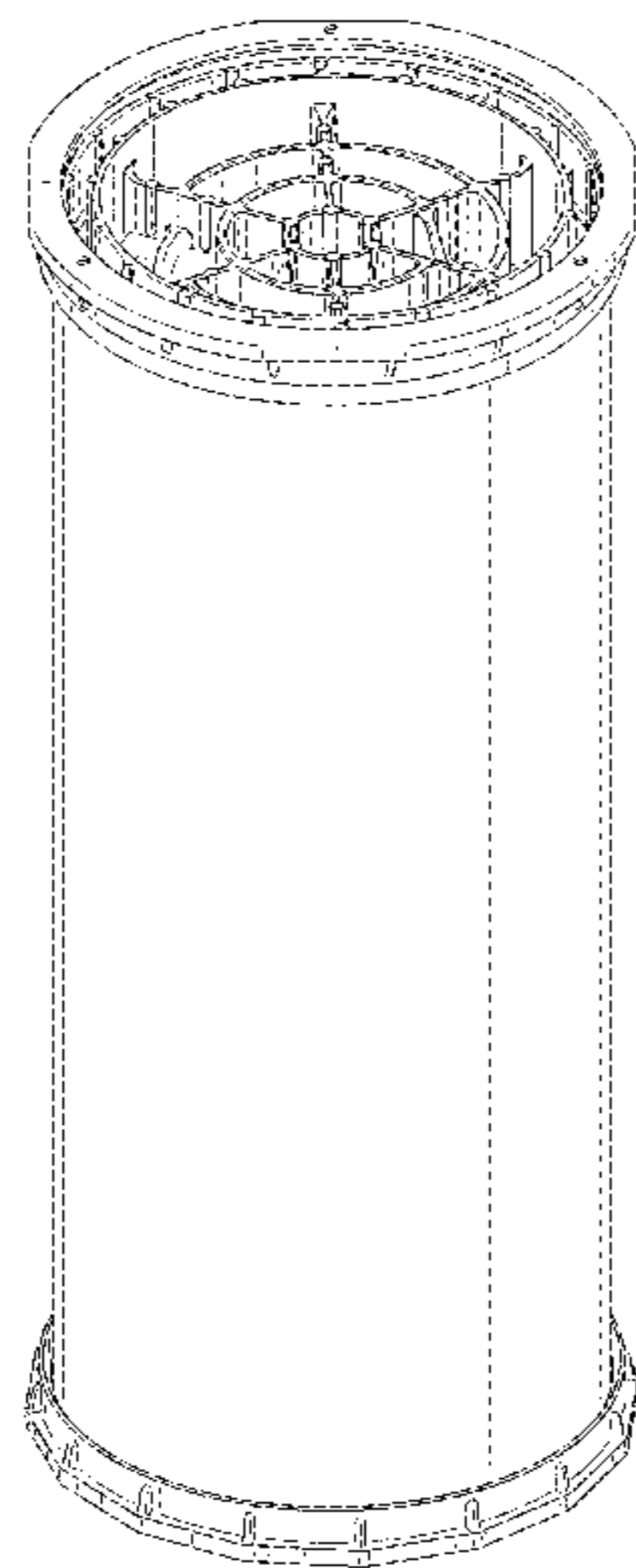

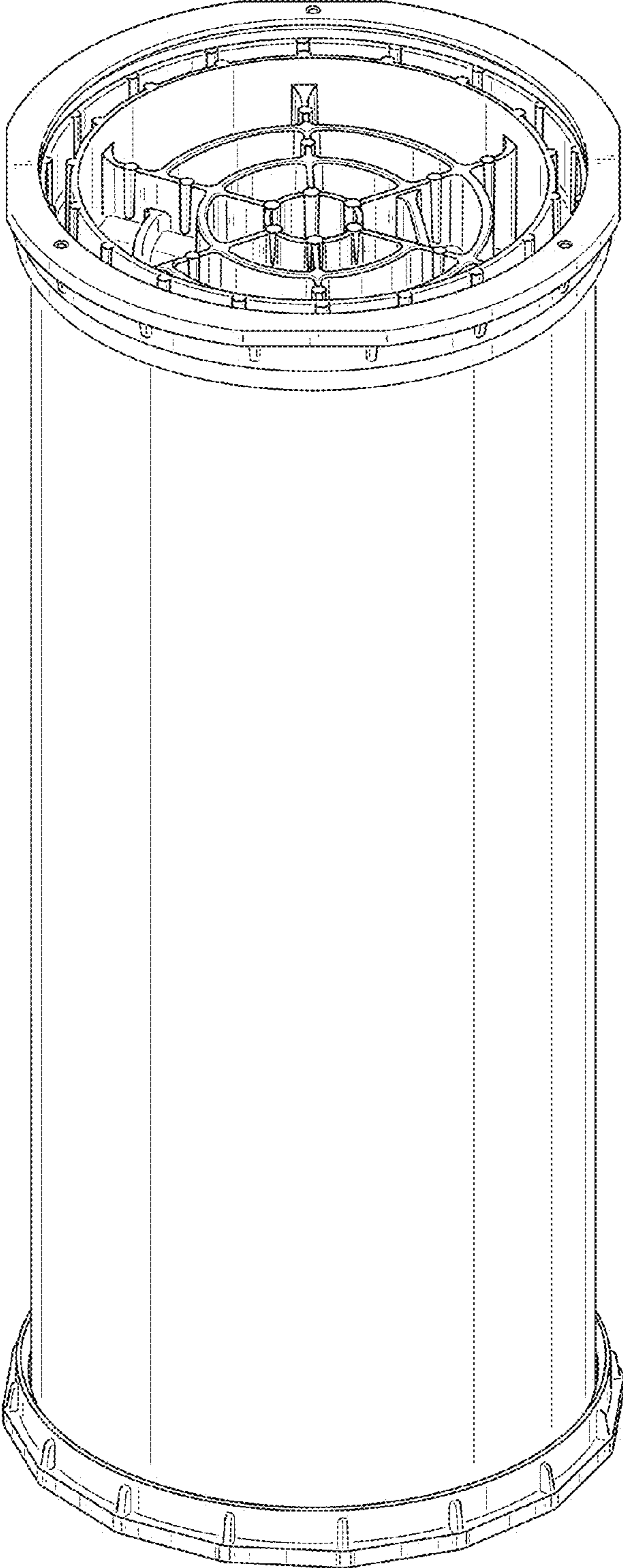

FIG. 1

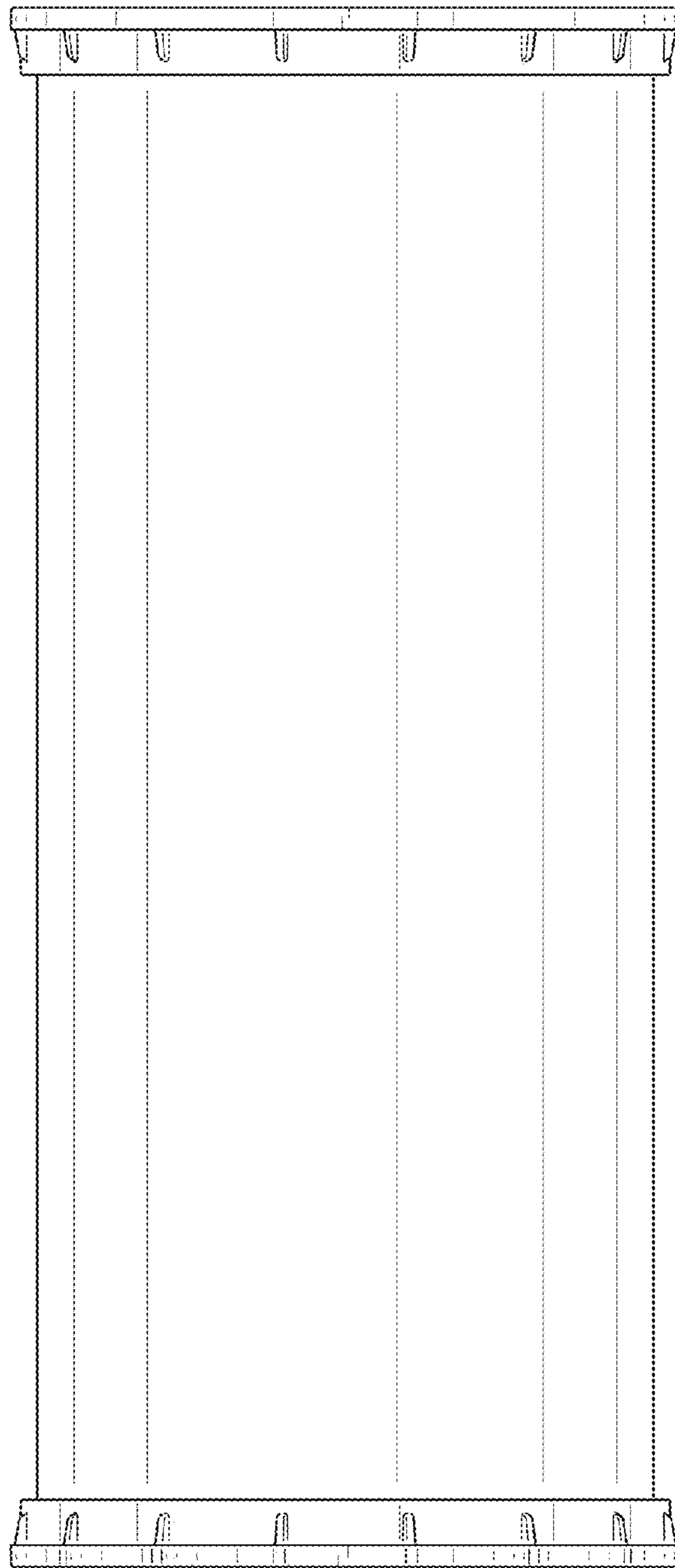

FIG. 2

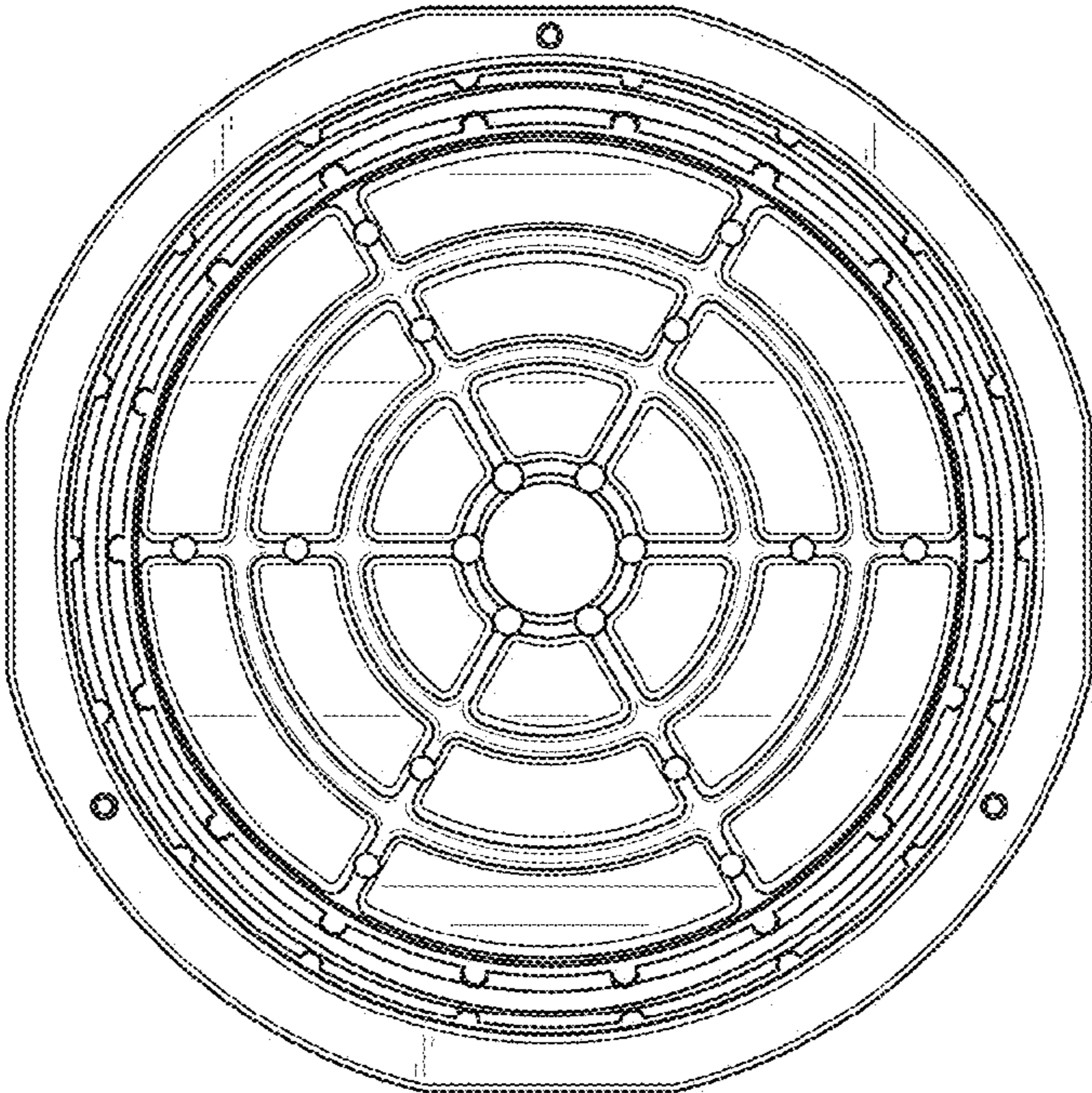

FIG. 3

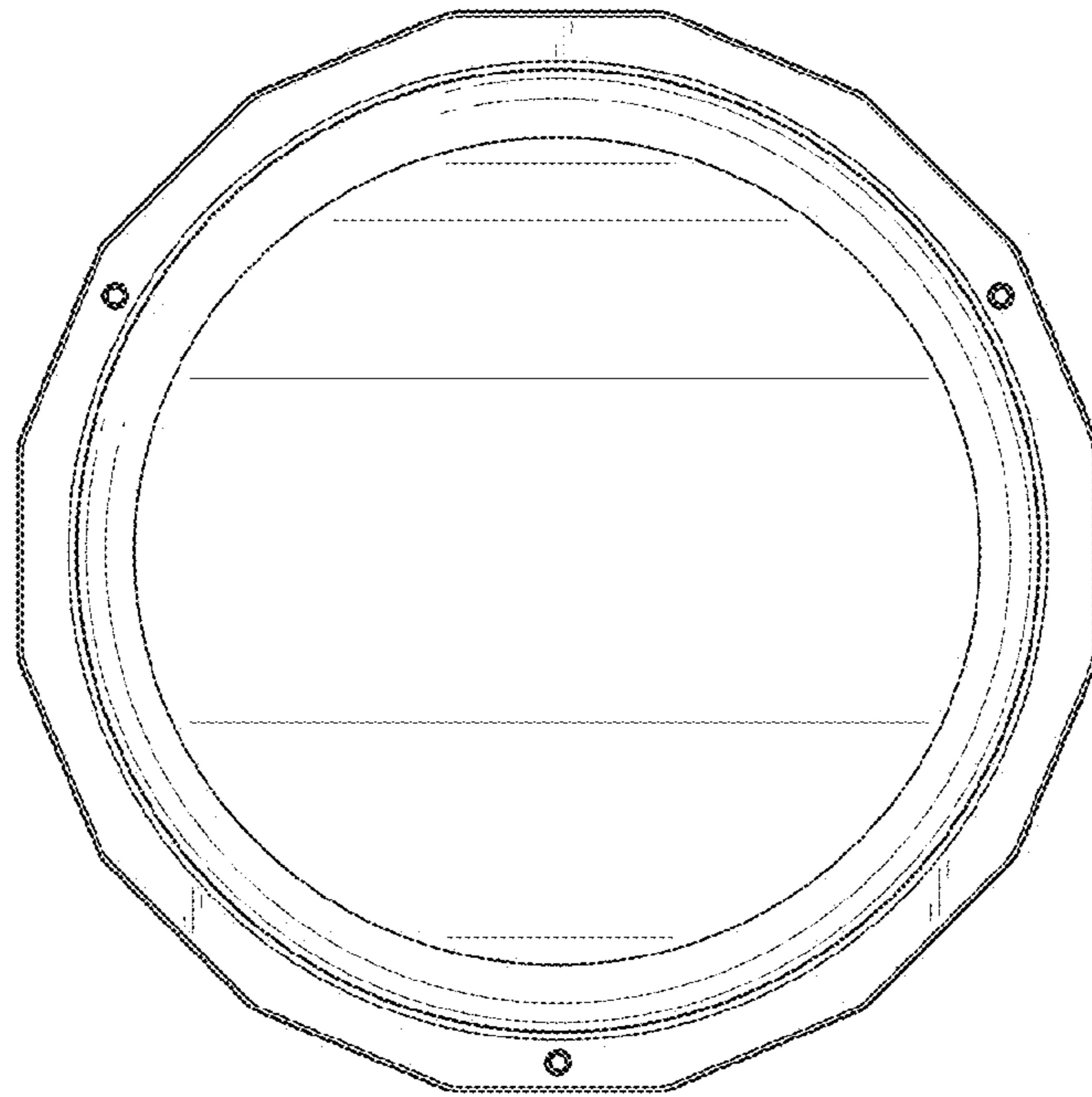

FIG. 4

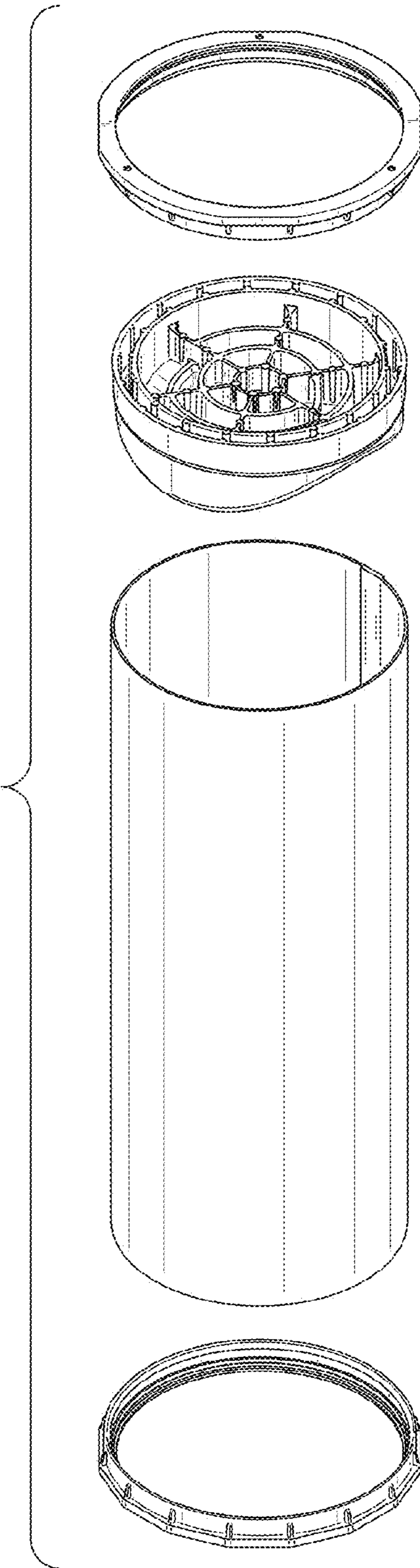

FIG. 5

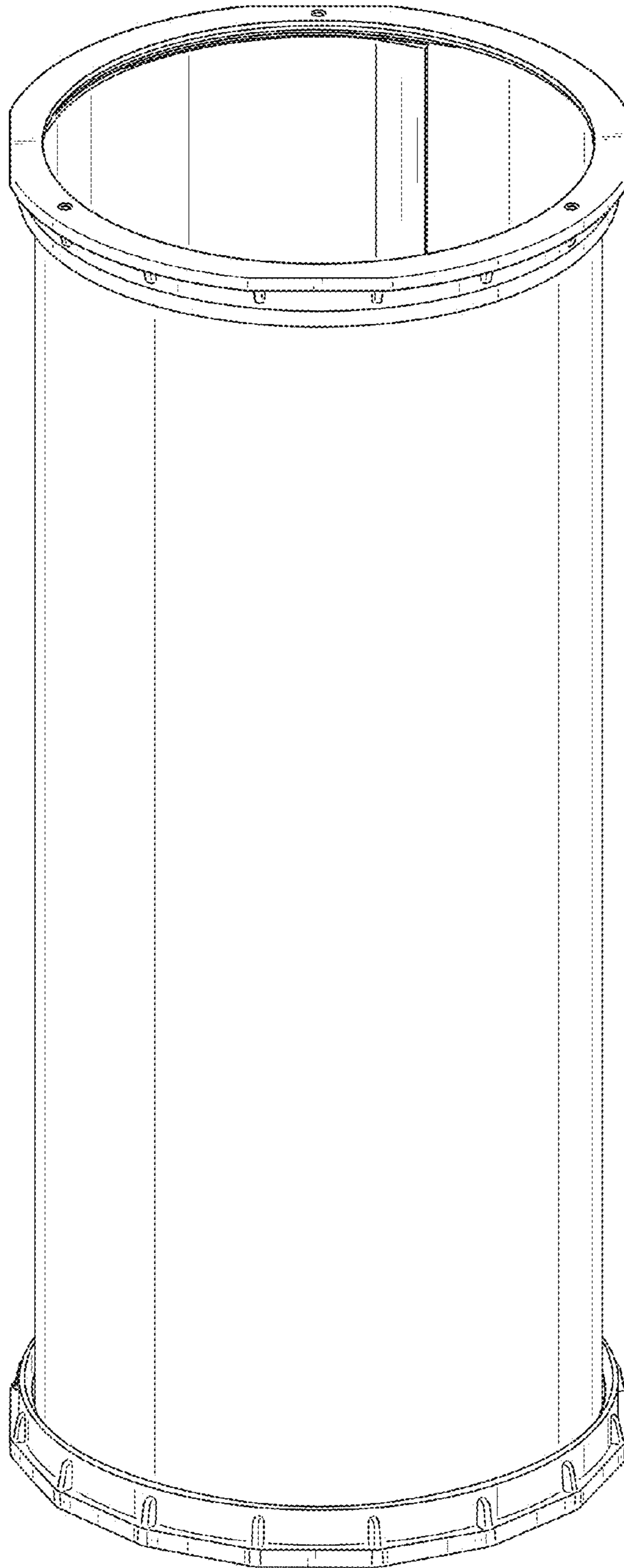

FIG. 6