



US00D731234S

(12) **United States Design Patent**  
**Weaden et al.**

(10) **Patent No.:** **US D731,234 S**  
(45) **Date of Patent:** **\*\* Jun. 9, 2015**

(54) **ELECTRIC BLENDER**

(56) **References Cited**

(71) Applicant: **Kenwood Limited**, Havant, Hampshire (GB)

U.S. PATENT DOCUMENTS

(72) Inventors: **Jamie Weaden**, Havant (GB); **Sam Davies**, Havant (GB)

D176,257 S \* 12/1955 Hill et al. .... D7/386  
D181,541 S \* 11/1957 Madl et al. .... D7/378  
D187,684 S \* 4/1960 Hauser ..... D7/386  
3,175,594 A \* 3/1965 Jepson et al. .... 241/199.12

(73) Assignee: **KENWOOD LIMITED**, Havant, Hampshire (GB)

(Continued)

(\*\*) Term: **14 Years**

FOREIGN PATENT DOCUMENTS

(21) Appl. No.: **29/491,942**

AU 340781 S 2/2012  
EM 000214184-0001 10/2004  
EM 000393970-0001 11/2005

(22) Filed: **May 27, 2014**

OTHER PUBLICATIONS

(30) **Foreign Application Priority Data**

Office Action dated Jan. 21, 2015 from corresponding Russian Application No. 2014502108 (17 pages including English translation).

Nov. 29, 2013 (ES) ..... 002354639-0001

*Primary Examiner* — Ricky Pham

(51) **LOC (10) Cl.** ..... **31-00**

(74) *Attorney, Agent, or Firm* — Brinks Gilson & Lione; G. Peter Nichols

(52) **U.S. Cl.**

USPC ..... **D7/378**; D7/376; D7/384

(58) **Field of Classification Search**

(57) **CLAIM**

USPC ..... D7/326, 372, 376–386, 412–413, 602, D7/629, 665–666, 669, 679, 693–694; 99/509–511; 241/92, 98, 241/101.01–101.2, 166–169.1, 199.12, 241/274–278.2, 285.1–285.3, 291, 292.1; 318/443; 366/64–65, 97–98, 100, 130, 366/197–201, 205–207, 219–220, 341–343  
CPC ..... A21C 1/02; A21C 1/04; A23N 1/00; A23N 1/02; A47J 43/04; A47J 43/25; A47J 43/27; A47J 43/042; A47J 43/044; A47J 43/046; A47J 43/075; A47J 43/0722; A47J 43/0727; B01F 3/00; B01F 3/0807; B01F 3/0853; B01F 13/0059; B01F 13/0064; B02C 1/08; B02C 2/04; B02C 4/42; B02C 4/142; B02C 4/143; B02C 4/423; B02C 13/1835; B28C 5/10; B28C 5/12; B28C 5/14; B28C 5/16; H02P 7/295

The ornamental design for an electric blender, as shown and described.

**DESCRIPTION**

FIG. 1 is a front perspective view of an electric blender of the present invention;  
FIG. 2 is a front view;  
FIG. 3 is a rear view;  
FIG. 4 is a left side view;  
FIG. 5 is a top view;  
FIG. 6 is a right side view; and,  
FIG. 7 is a bottom view.  
The broken lines shown in the drawings represent unclaimed portions and form no part of the claimed design.

See application file for complete search history.

**1 Claim, 4 Drawing Sheets**

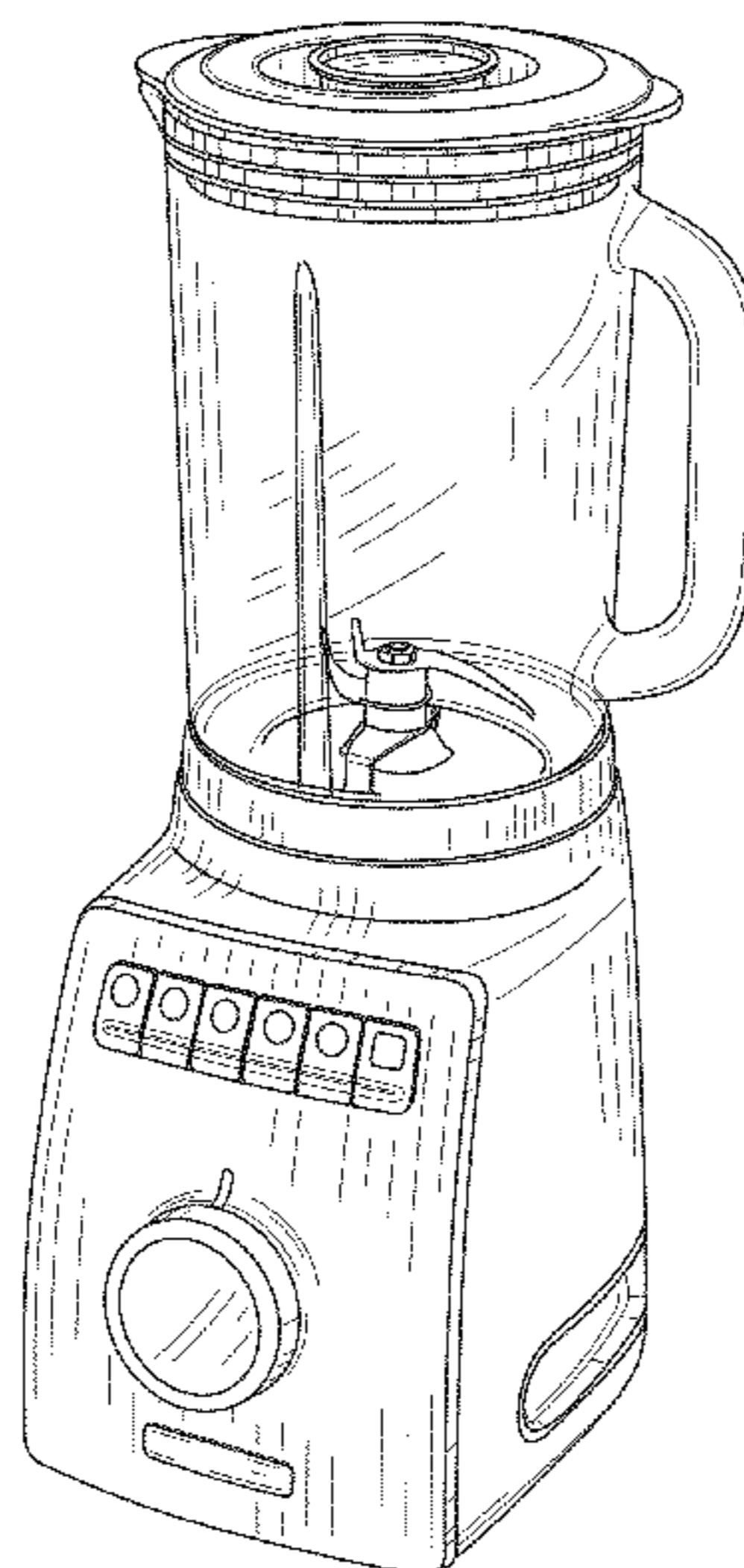

(56)

**References Cited**

U.S. PATENT DOCUMENTS

3,548,280 A \* 12/1970 Cockroft ..... 318/443  
D507,149 S \* 7/2005 Ball et al. .... D7/386  
D533,020 S \* 12/2006 Kassenaar et al. .... D7/378  
D553,425 S \* 10/2007 Steiner et al. .... D7/378

D578,340 S \* 10/2008 Picozza et al. .... D7/378  
D597,372 S \* 8/2009 Nordwall et al. .... D7/378  
D616,244 S \* 5/2010 Thai et al. .... D7/378  
D642,858 S \* 8/2011 Lazzer ..... D7/378  
D679,935 S \* 4/2013 Tse et al. .... D7/326

\* cited by examiner

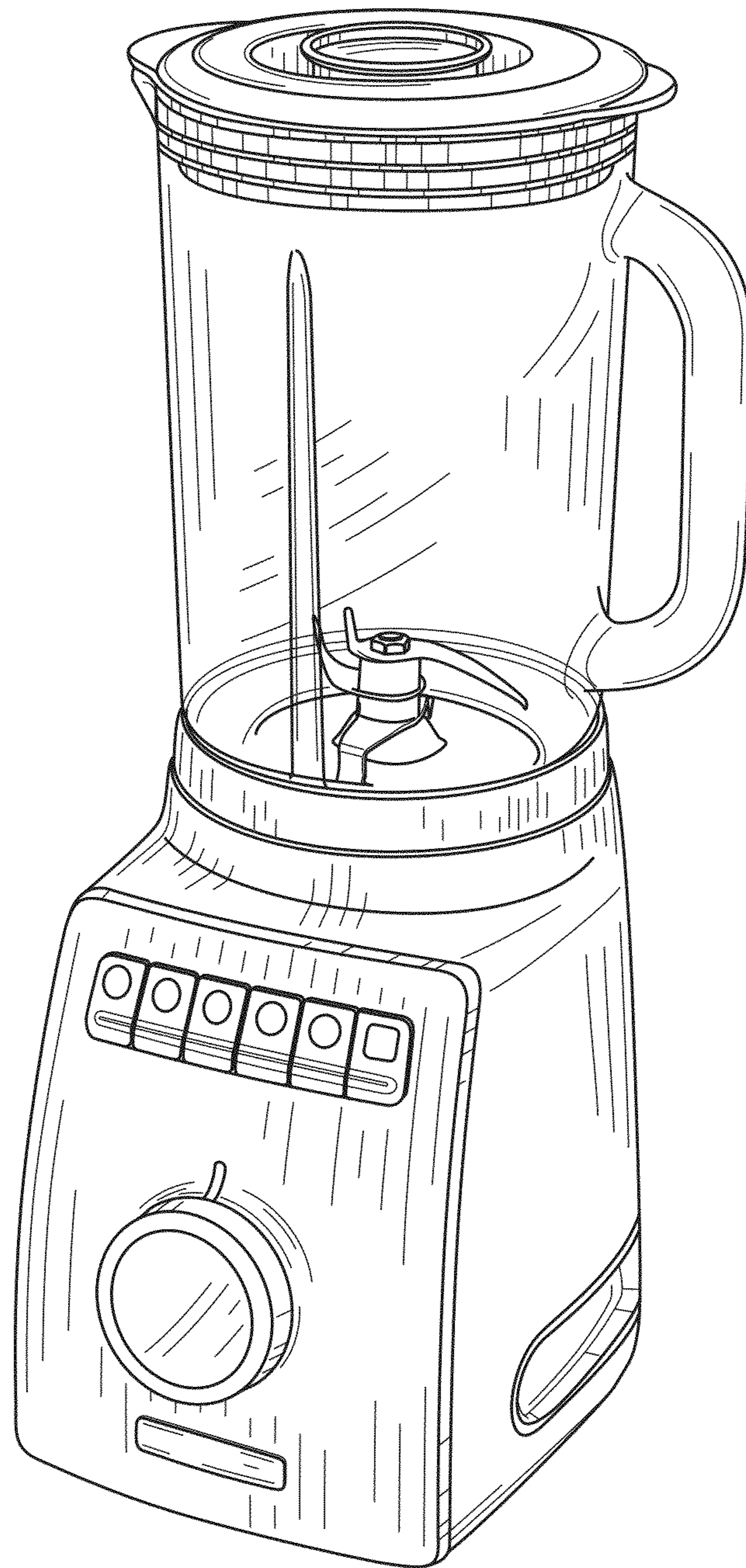

FIG. 1

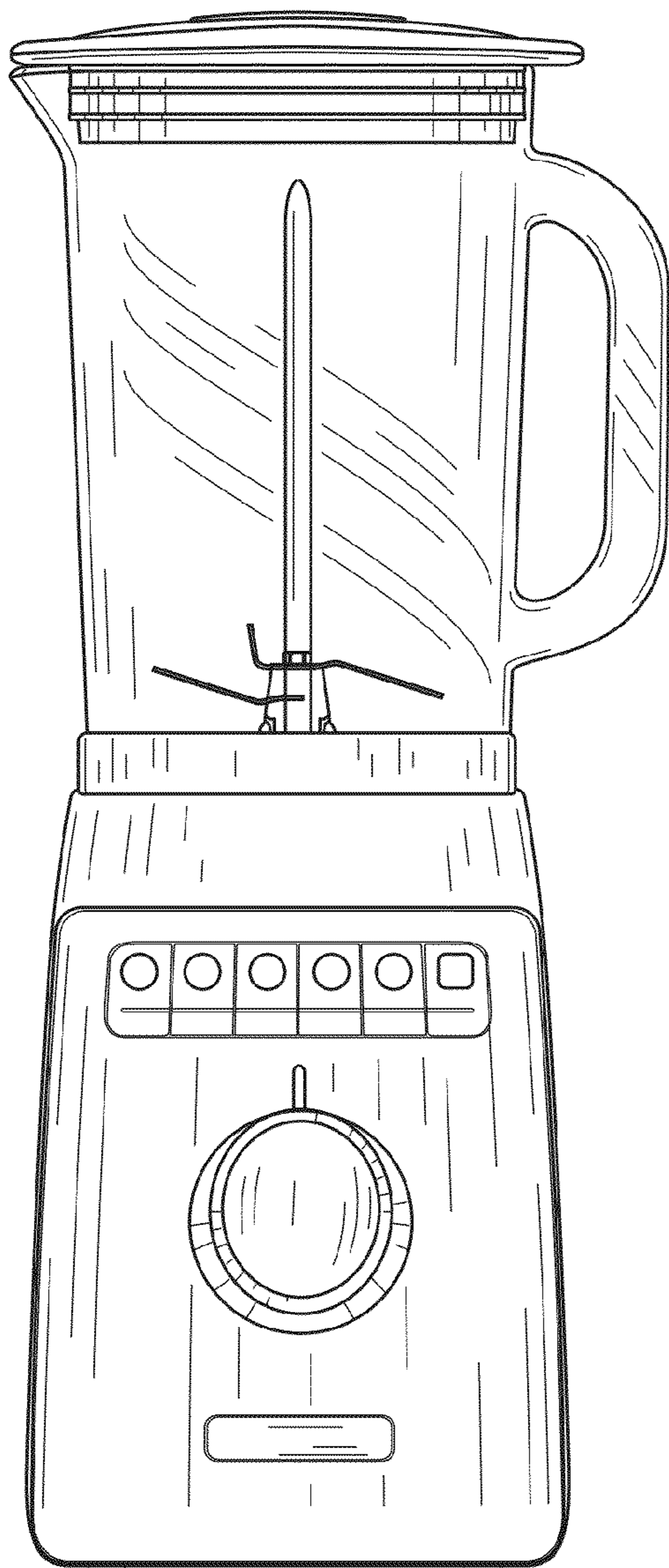

FIG. 2

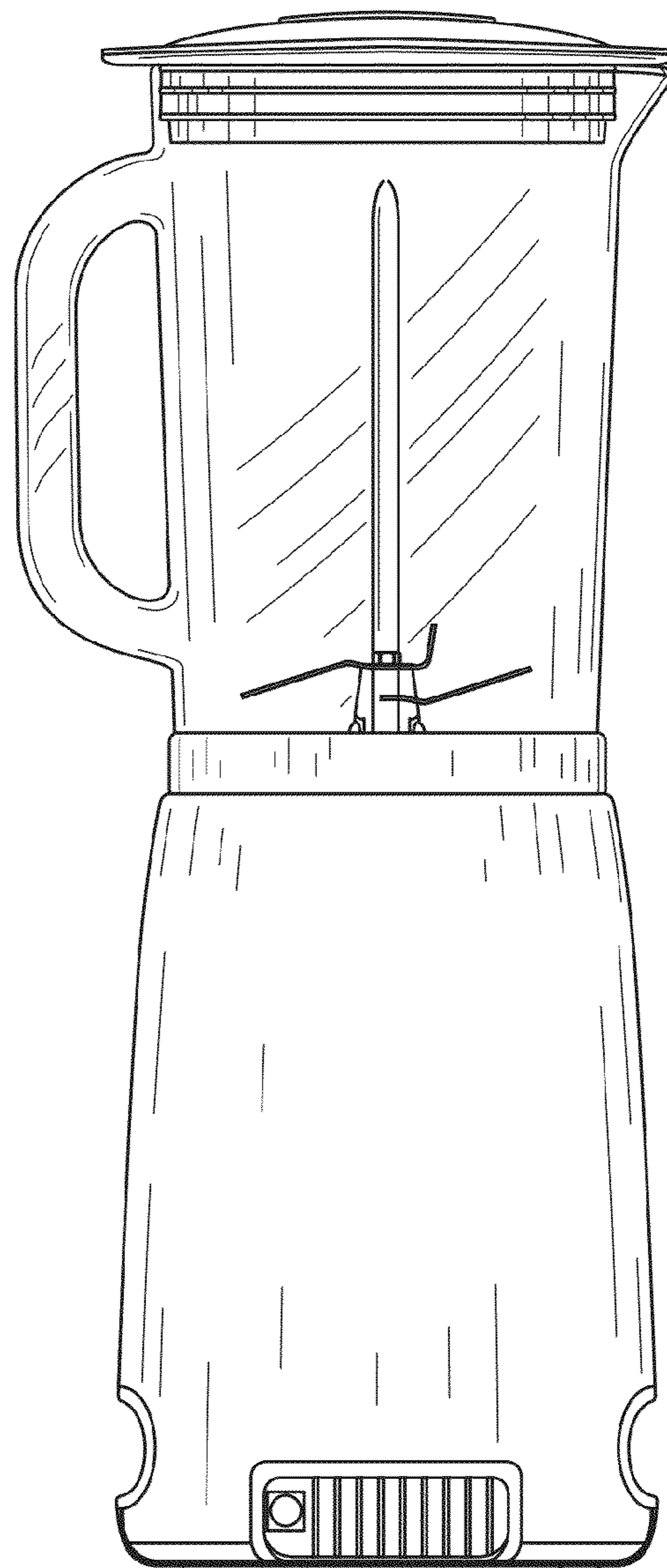

FIG. 3

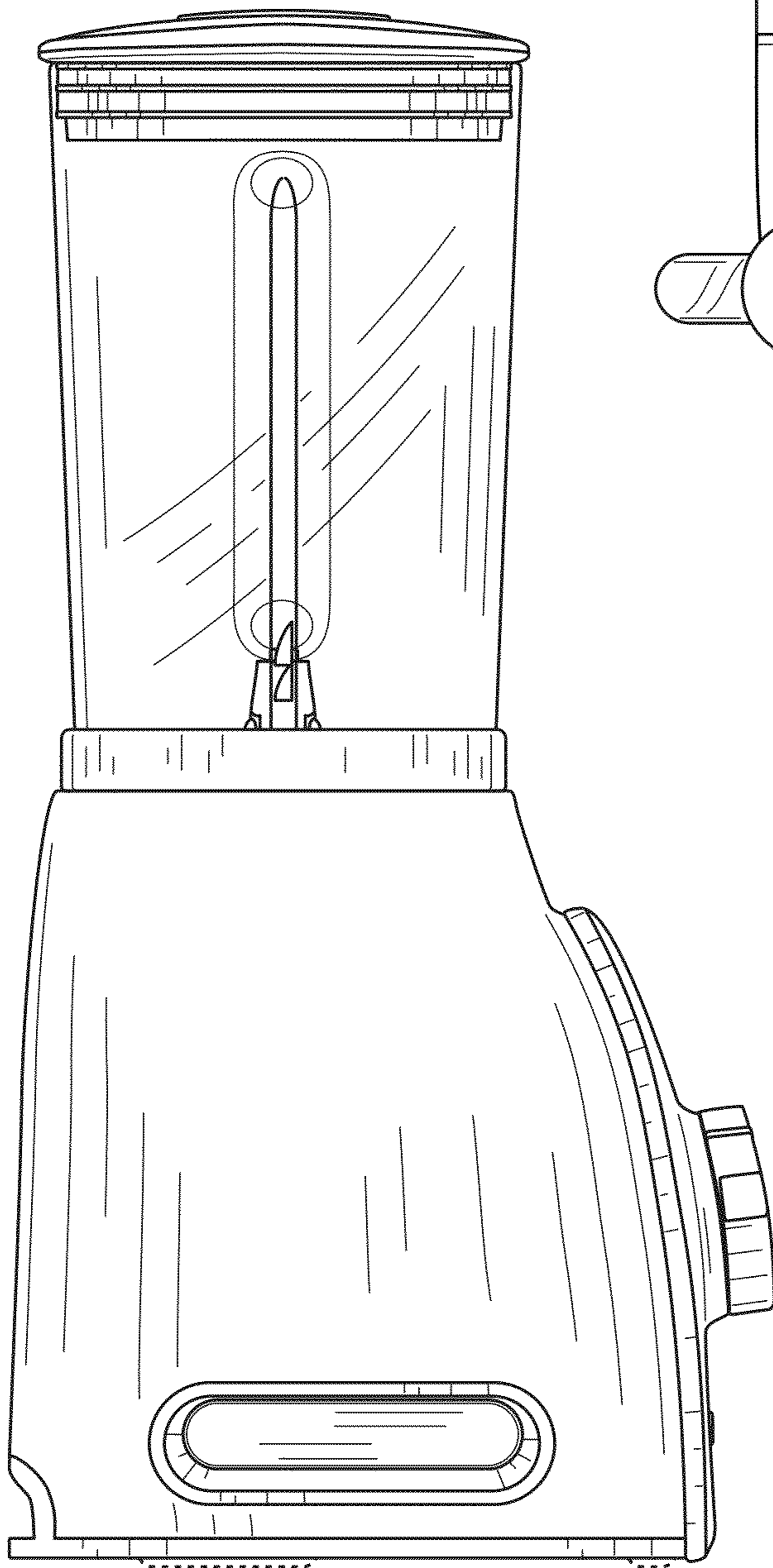

FIG. 4

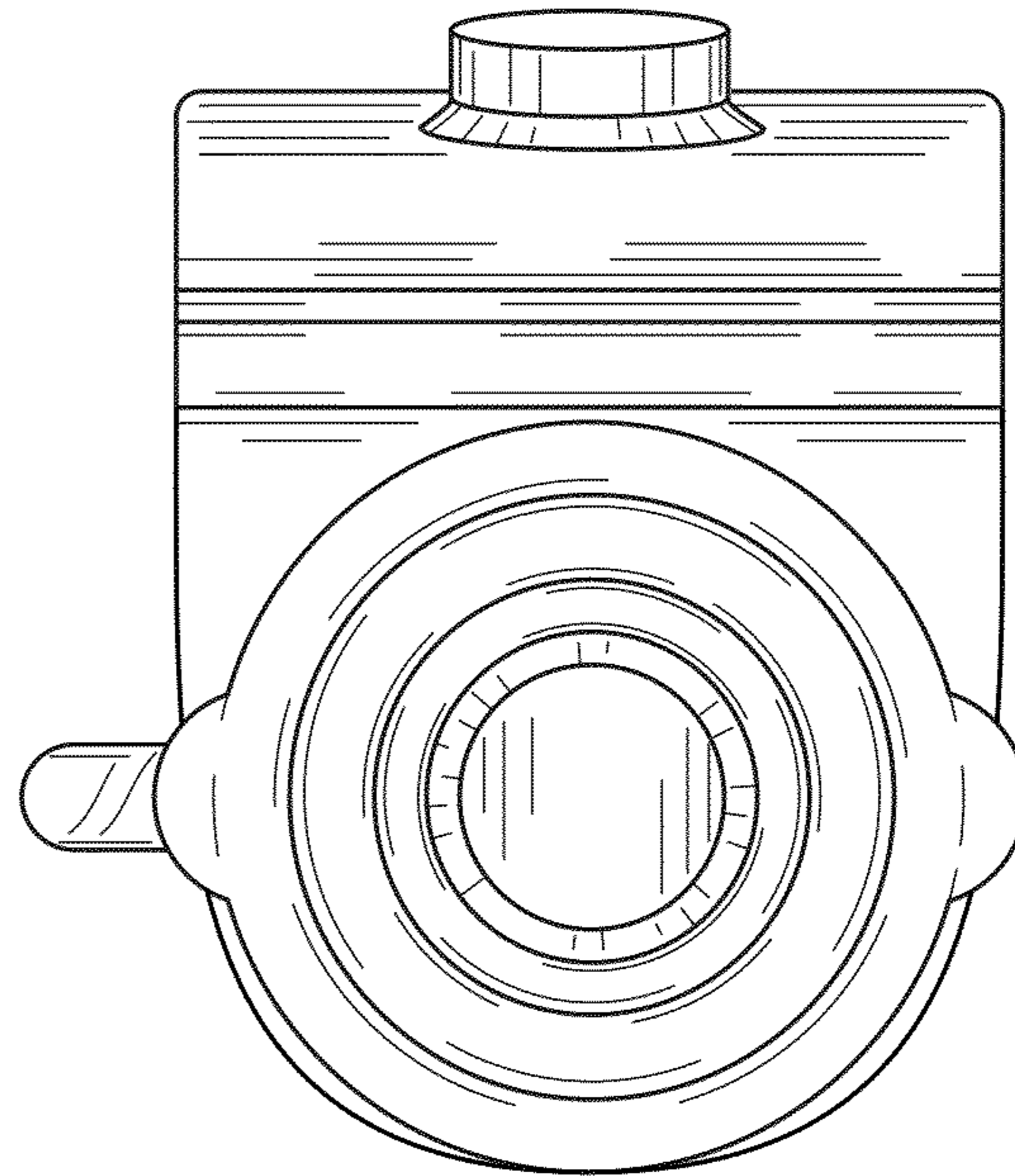

FIG. 5

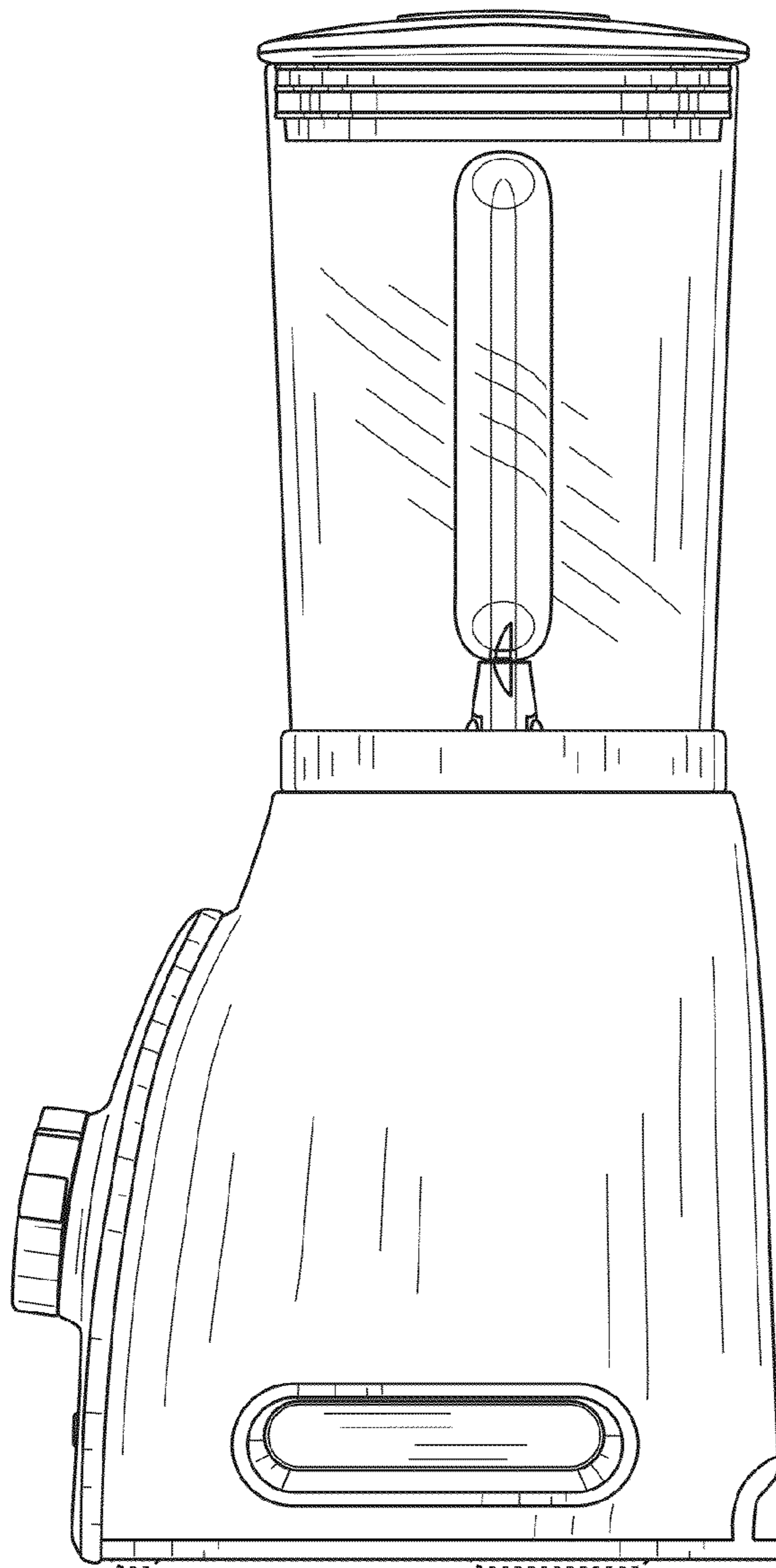

FIG. 6

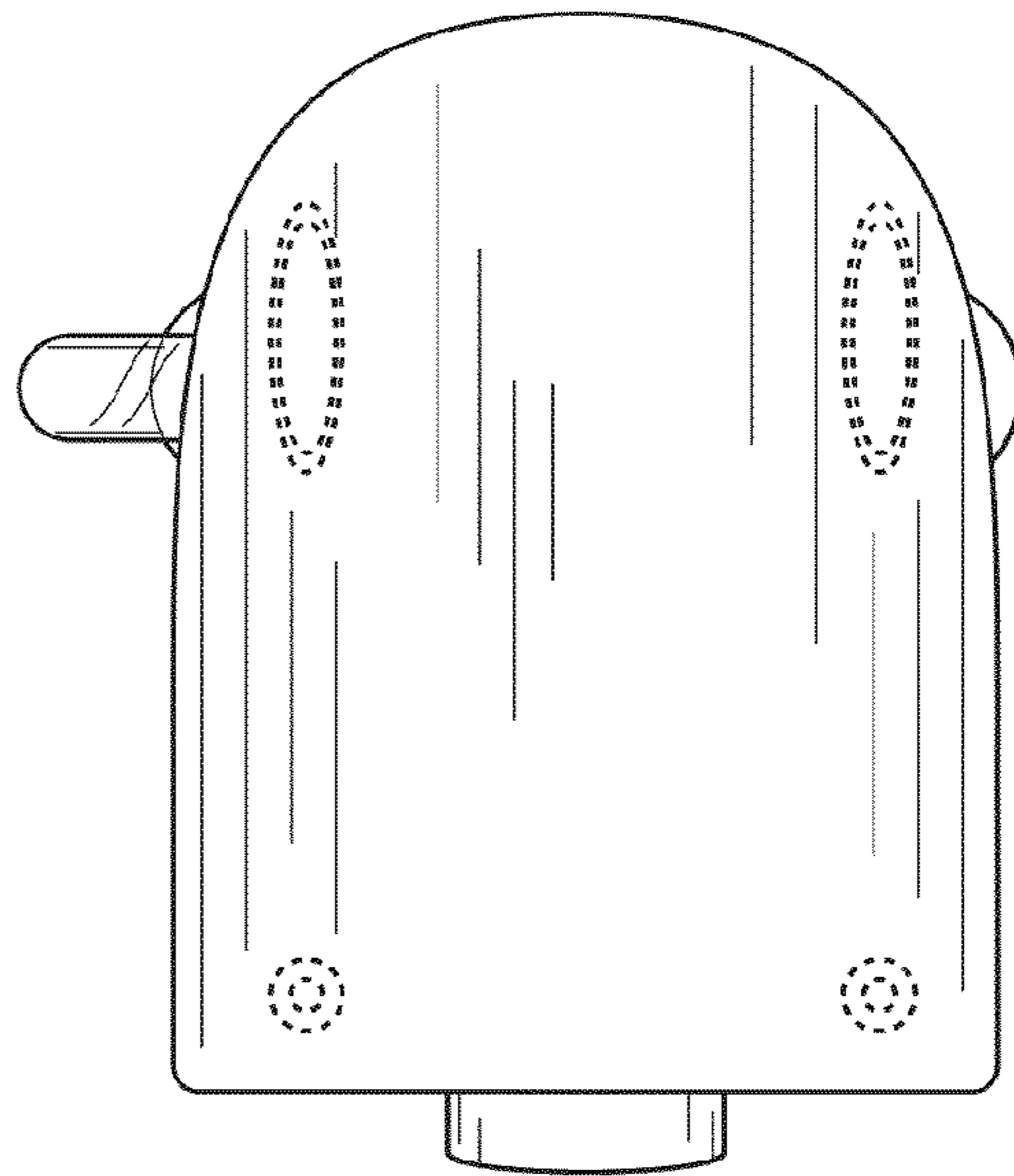

FIG. 7