



US00D731224S

(12) **United States Design Patent**
Melzer et al.

(10) **Patent No.:** **US D731,224 S**
(45) **Date of Patent:** **** Jun. 9, 2015**

(54) **BEVERAGE DISPENSER**
(71) Applicant: **Epoca International, Inc.**, Boca Raton, FL (US)
(72) Inventors: **Brian Melzer**, Boca Raton, FL (US);
Matthew L. Chin, New York, NY (US);
Gareth Brown, Jersey City, NJ (US)
(73) Assignee: **Epoca International, Inc.**, Boca Raton, FL (US)

D204,657 S * 5/1966 Jeffries D7/313
3,315,850 A * 4/1967 Gran 222/501
D255,883 S * 7/1980 Ferenc D10/121
D259,232 S * 5/1981 Tarozzi D7/313
D259,320 S * 5/1981 Tarozzi D7/313
D318,395 S * 7/1991 Juergens D7/311
D344,204 S * 2/1994 Dixon D7/301
D389,002 S * 1/1998 Demore et al. D7/313
D400,391 S * 11/1998 Hulley D7/313
D415,383 S * 10/1999 Le D7/306
7,328,816 B2 * 2/2008 Shannon et al. 222/185.1

* cited by examiner

(**) Term: **14 Years**
(21) Appl. No.: **29/480,637**

Primary Examiner — Marianne Pandozzi
(74) *Attorney, Agent, or Firm* — Akerman LLP

(22) Filed: **Jan. 28, 2014**
(51) **LOC (10) Cl.** **07-01**
(52) **U.S. Cl.**
USPC **D7/306**; D7/313; D7/397
(58) **Field of Classification Search**
USPC D7/397, 301, 300, 398, 313, 306–308,
D7/309–311; 239/445, 583; 222/511, 25,
222/192, 153.02, 185.1, 146.6; D20/8
CPC B67D 1/0084; B67D 1/0041; B67D 3/00;
A47J 31/00
See application file for complete search history.

(57) **CLAIM**
We claim the ornamental design for a beverage dispenser, as shown and described.

DESCRIPTION

FIG. 1 is a perspective view of the beverage dispenser, showing our new, original and ornamental design;
FIG. 2 is a front view thereof;
FIG. 3 is a back view thereof;
FIG. 4 is a side view thereof;
FIG. 5 is a second side view thereof;
FIG. 6 is a top view thereof; and,
FIG. 7 is a bottom view thereof.
The broken lines in the figures are for illustrative purposes only and form no part of the claimed design.

(56) **References Cited**
U.S. PATENT DOCUMENTS
D155,116 S * 9/1949 Addelston et al. D7/313
D203,774 S * 2/1966 Gentry D7/313

1 Claim, 7 Drawing Sheets

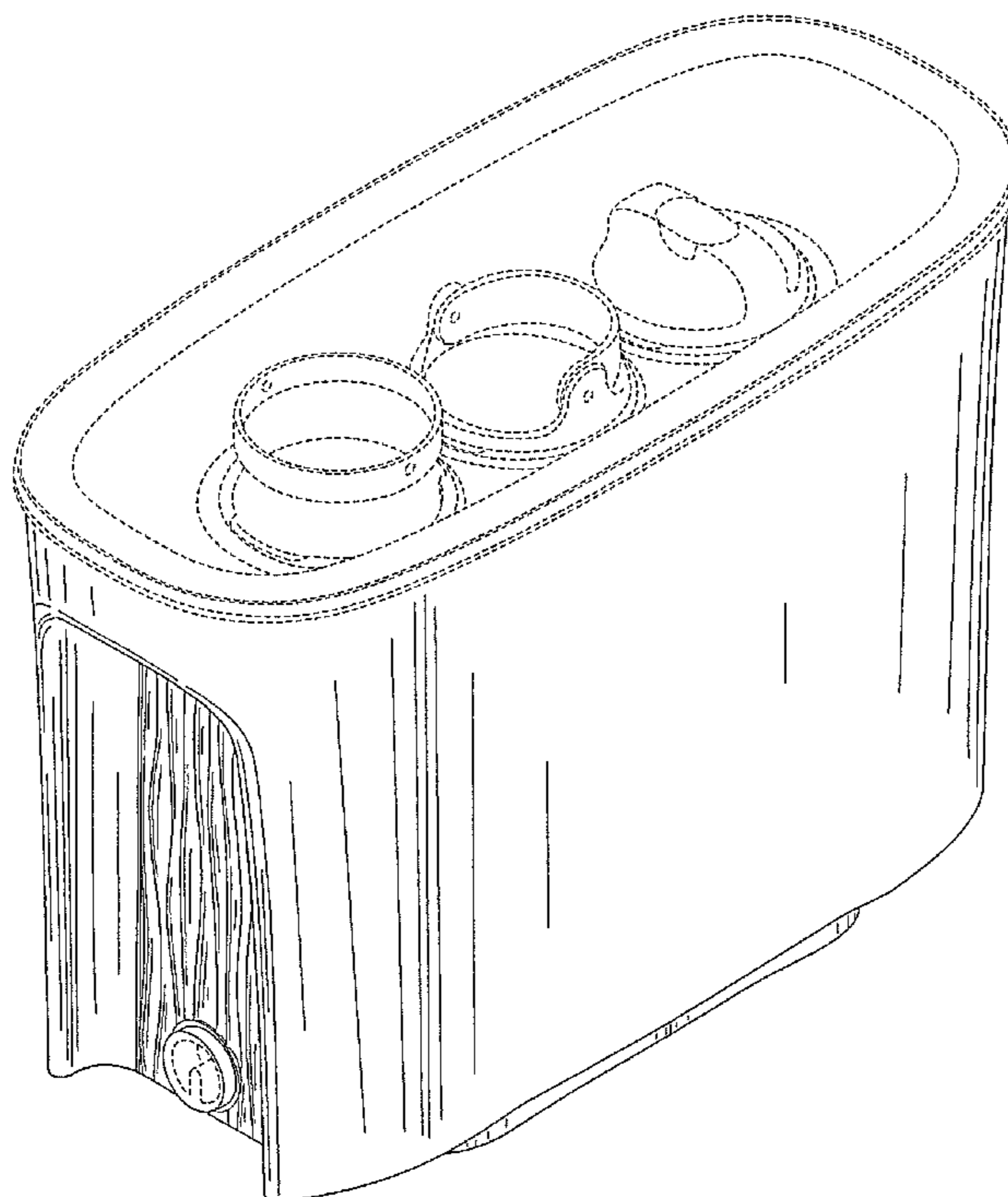

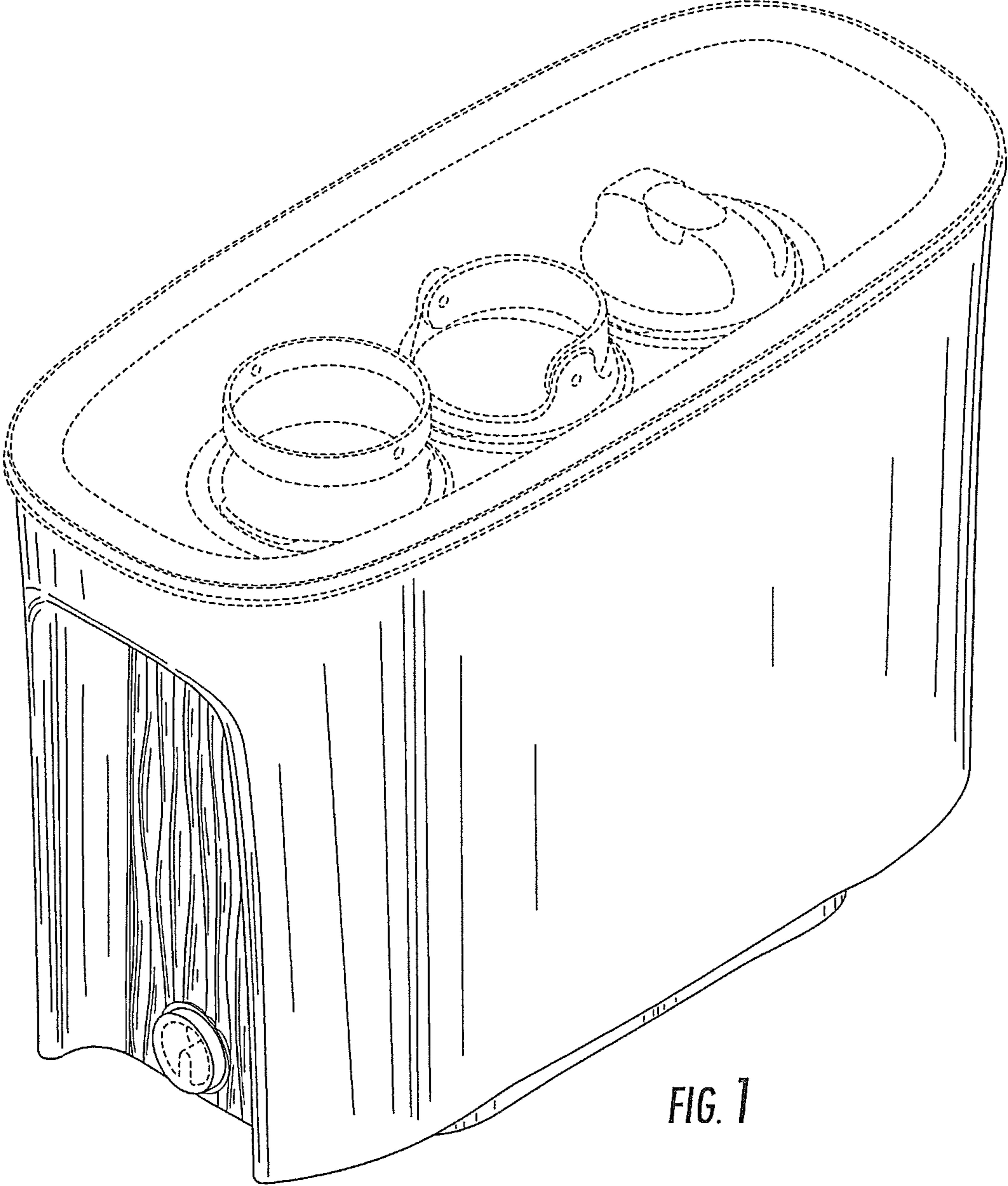

FIG. 1

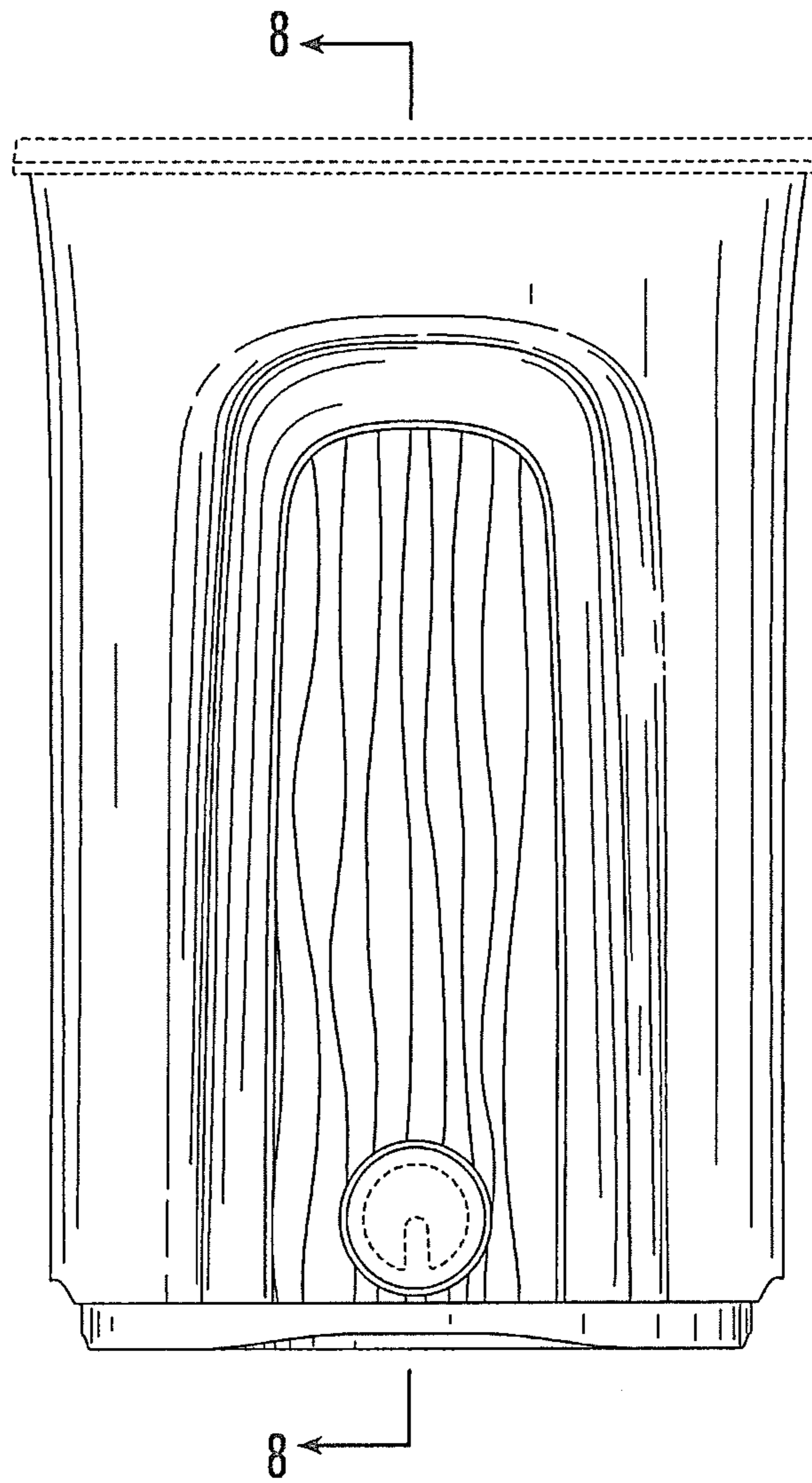

FIG. 2

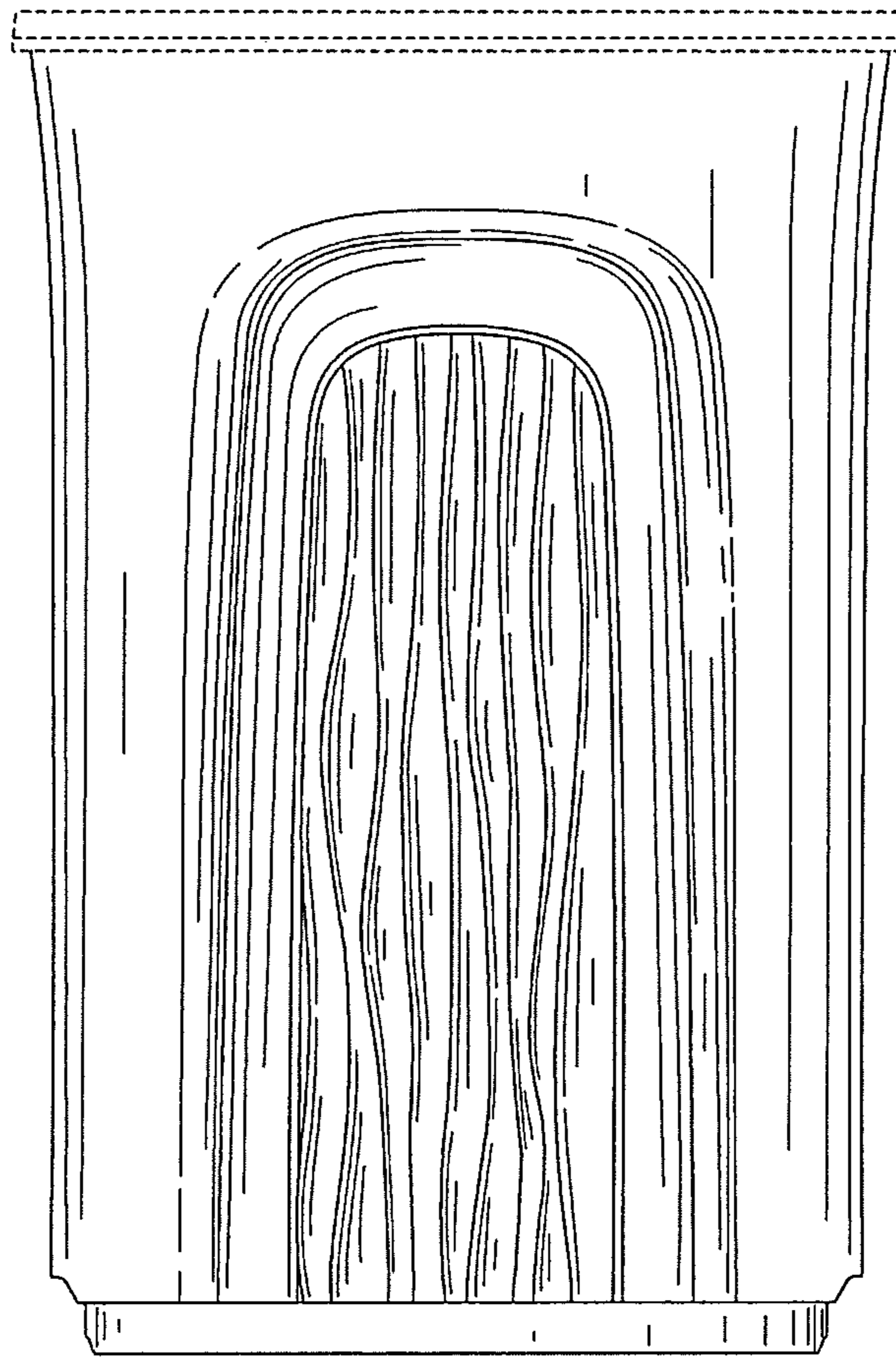

FIG. 3

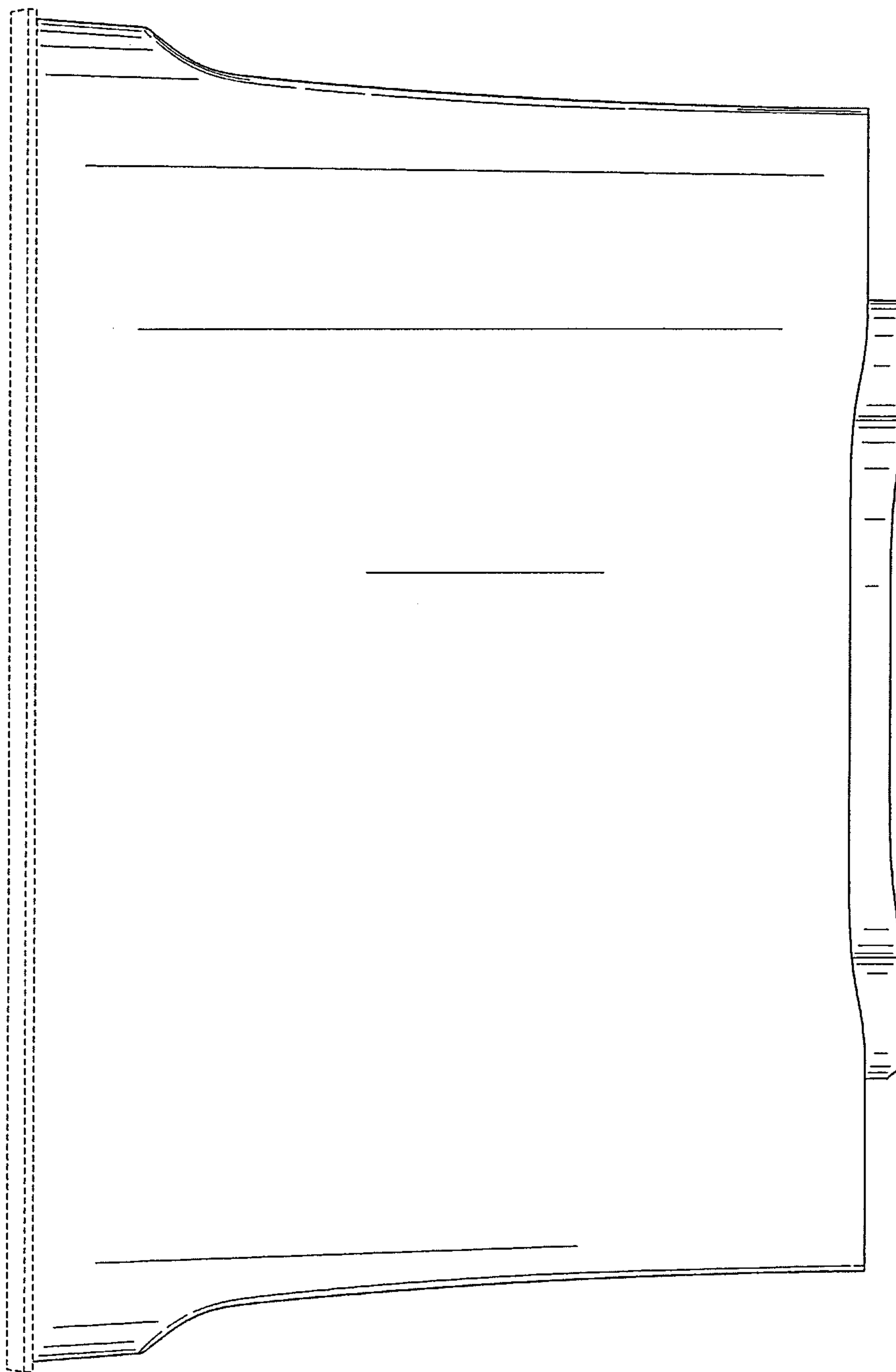

FIG. 4

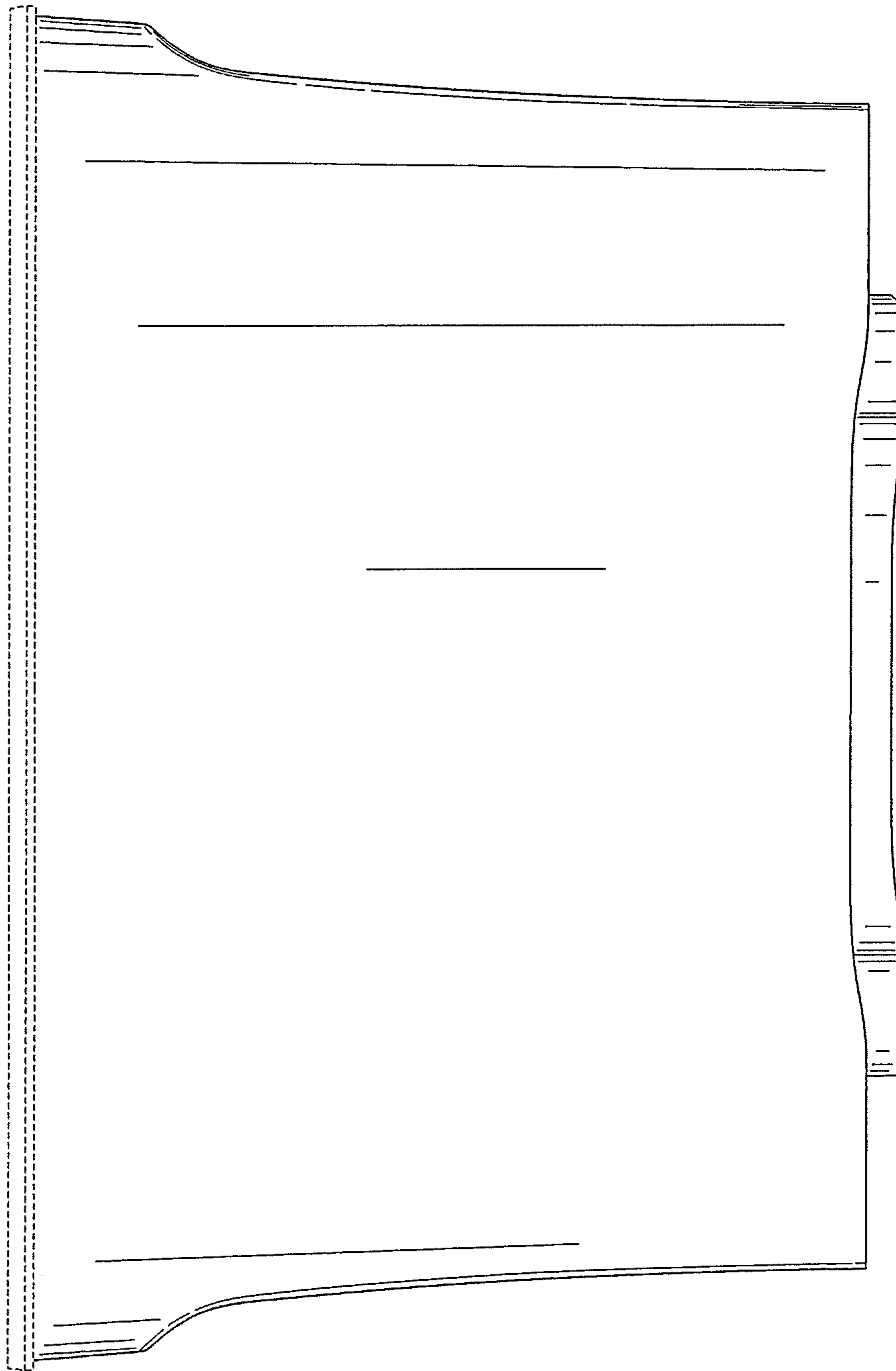

FIG. 5

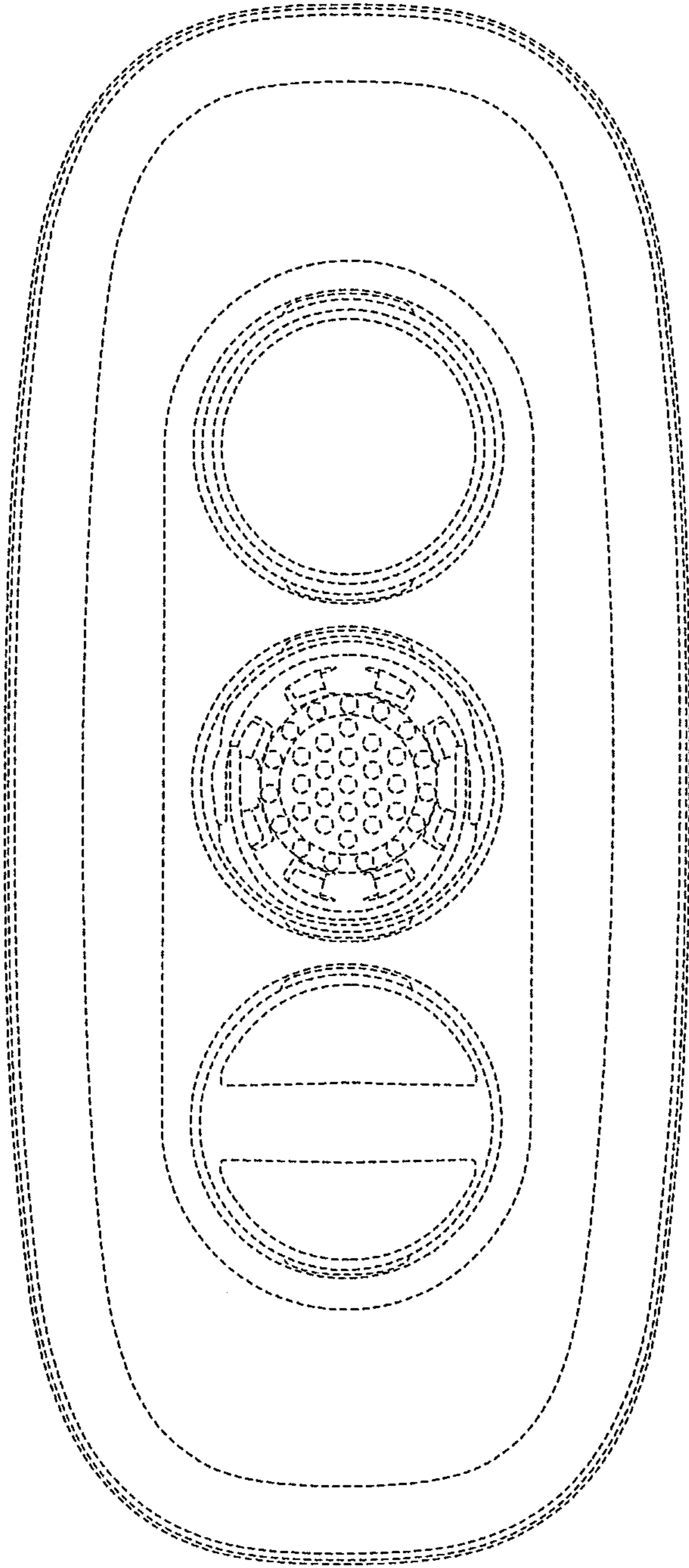

FIG. 6

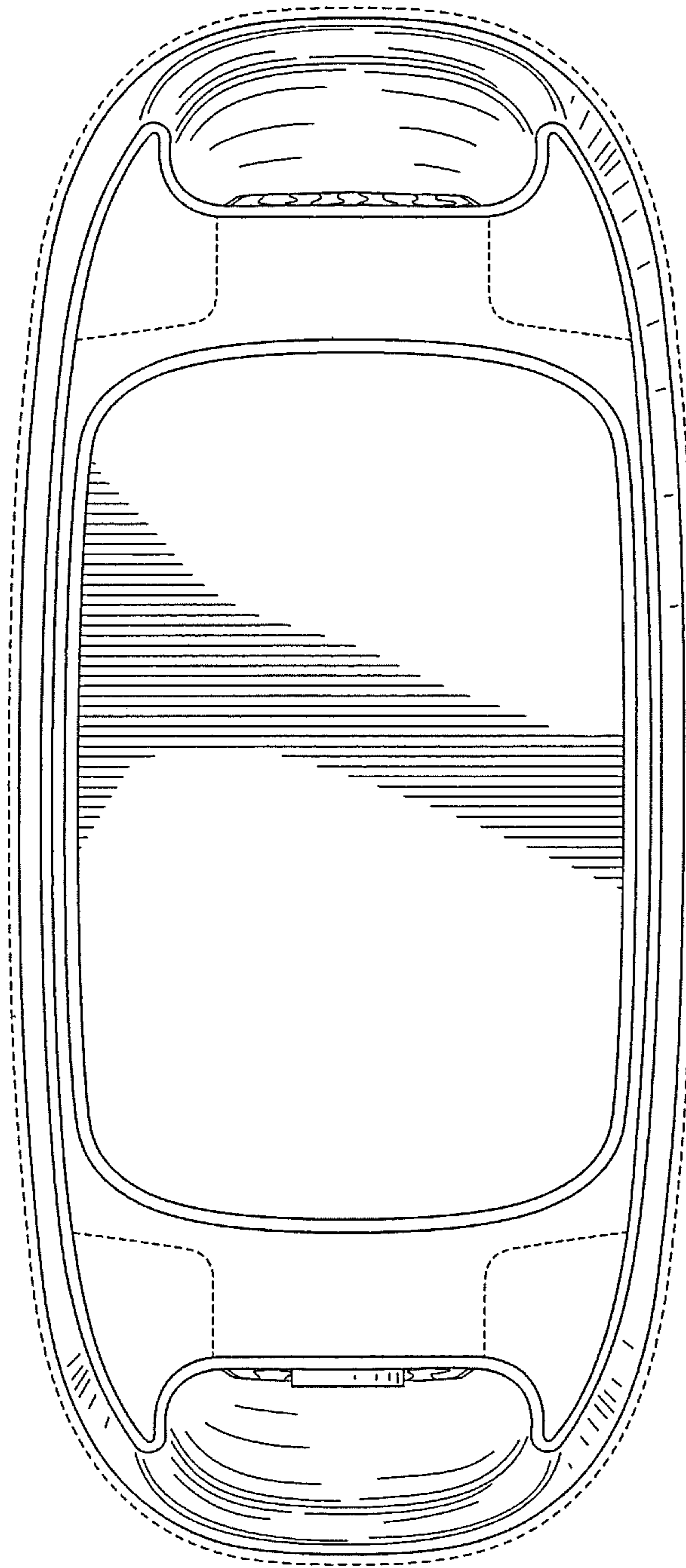

FIG. 7