



US00D731150S

(12) **United States Design Patent**  
**Styles**

(10) **Patent No.:** **US D731,150 S**

(45) **Date of Patent:** **\*\* Jun. 9, 2015**

(54) **PANTS**

(71) Applicant: **Kim Ellen Styles**, Panama City Beach,  
FL (US)

(72) Inventor: **Kim Ellen Styles**, Panama City Beach,  
FL (US)

(\*\*) Term: **14 Years**

(21) Appl. No.: **29/488,954**

(22) Filed: **Apr. 24, 2014**

(51) **LOC (10) Cl.** ..... **02-02**

(52) **U.S. Cl.**  
USPC ..... **D2/742**

(58) **Field of Classification Search**  
USPC ..... D2/731, 738, 739, 742, 743, 745; 2/75,  
2/79, 80, 83, 227-229, 235-238, 242,  
2/269

See application file for complete search history.

(56) **References Cited**

**U.S. PATENT DOCUMENTS**

5,634,215	A *	6/1997	DeBaene	.....	2/227
5,956,775	A *	9/1999	Ezra	.....	2/227
D485,049	S *	1/2004	Newson	.....	D2/742
D527,866	S *	9/2006	Fixel	.....	D2/742
D561,979	S *	2/2008	Eichelberger	.....	D2/742

D572,433	S *	7/2008	Peters	.....	D2/742
D641,134	S *	7/2011	Zarabi	.....	D2/712
D668,433	S *	10/2012	Boyle	.....	D2/742
D680,299	S *	4/2013	Scott	.....	D2/742
2009/0293167	A1 *	12/2009	Kottler	.....	2/23
2013/0125287	A1 *	5/2013	Boyle	.....	2/70

\* cited by examiner

*Primary Examiner* — Rashida Johnson

(74) *Attorney, Agent, or Firm* — Akerman LLP; Peter A. Chiabotti; Ryan L. Harding

(57) **CLAIM**

The ornamental design for pants, as shown and described.

**DESCRIPTION**

FIG. 1 is a perspective view of pants showing my new design;  
FIG. 2 is a front view thereof;  
FIG. 3 is a rear elevation view thereof;  
FIG. 4 is a right side elevation view thereof;  
FIG. 5 is a left side elevation view thereof;  
FIG. 6 is a top plan view thereof; and,  
FIG. 7 is a bottom plan view thereof.  
The broken lines in the figures illustrate portions of the pants  
that form no part of the claimed design.

**1 Claim, 5 Drawing Sheets**

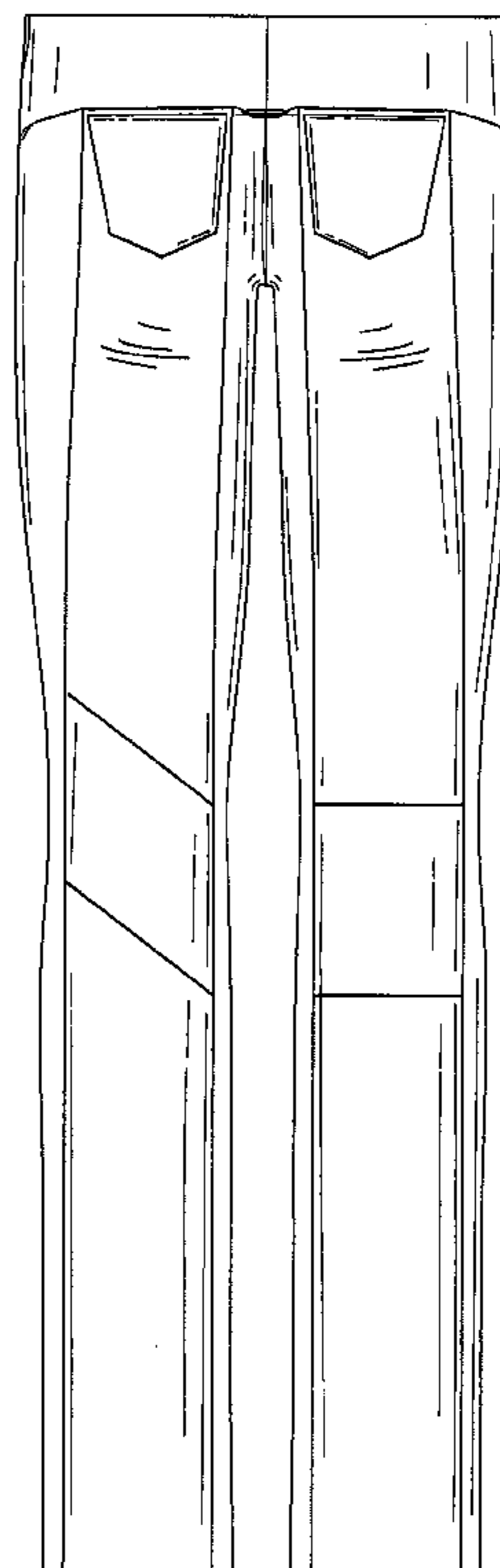
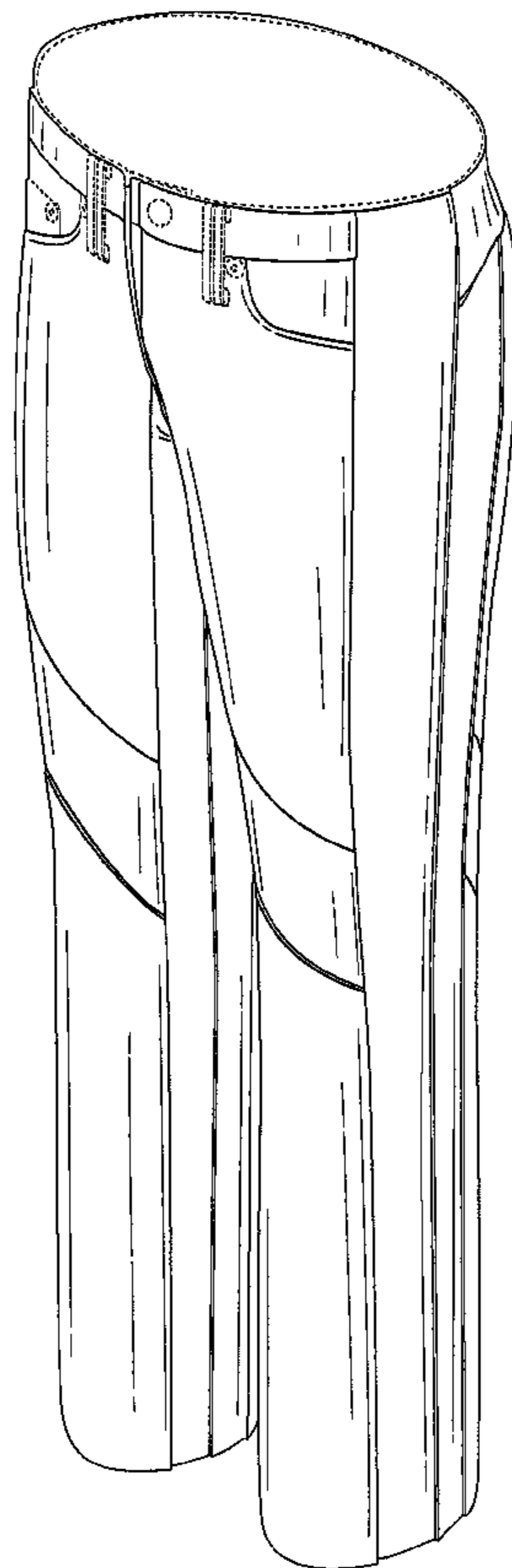

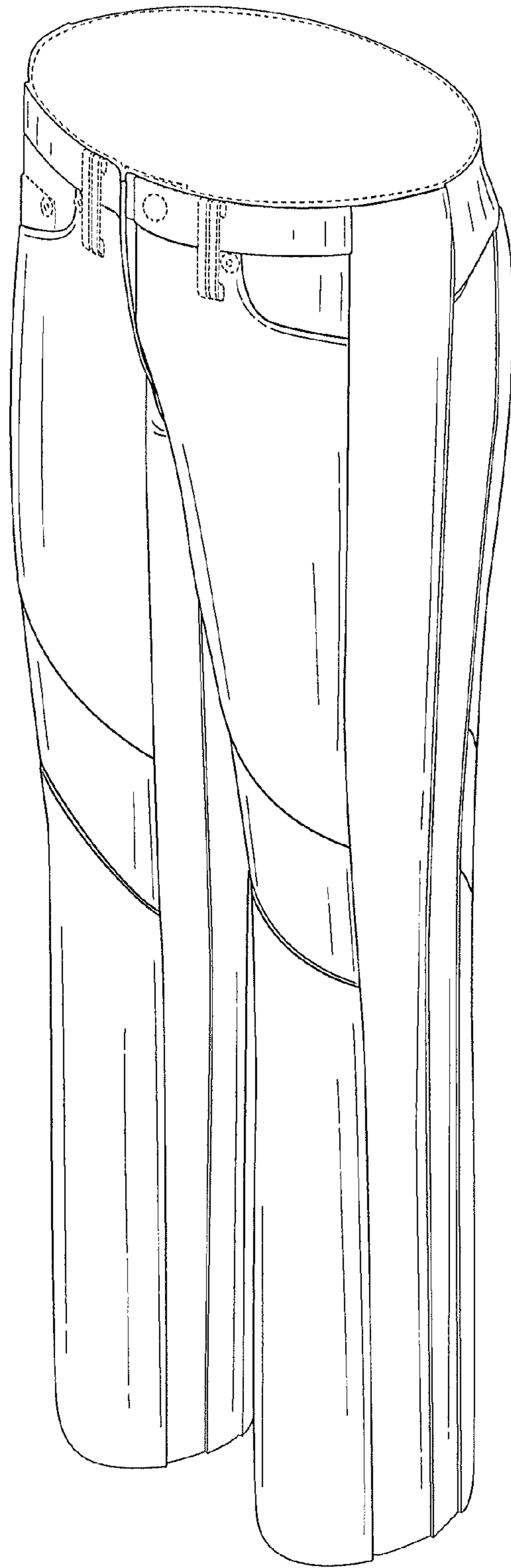

FIG. 1

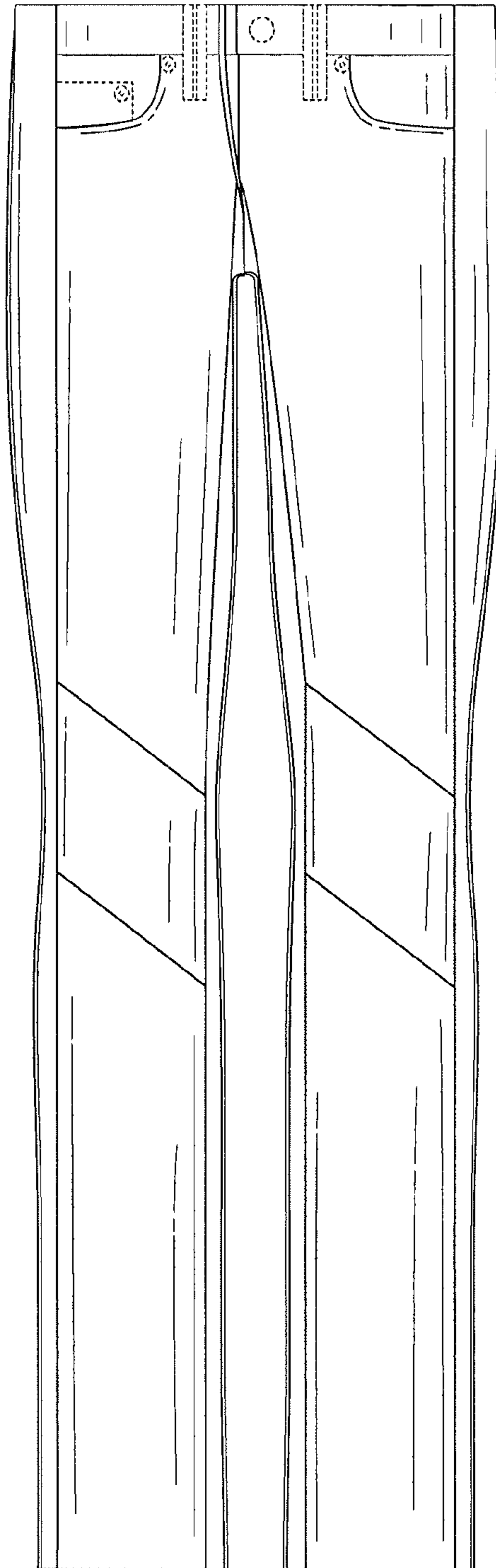

FIG. 2

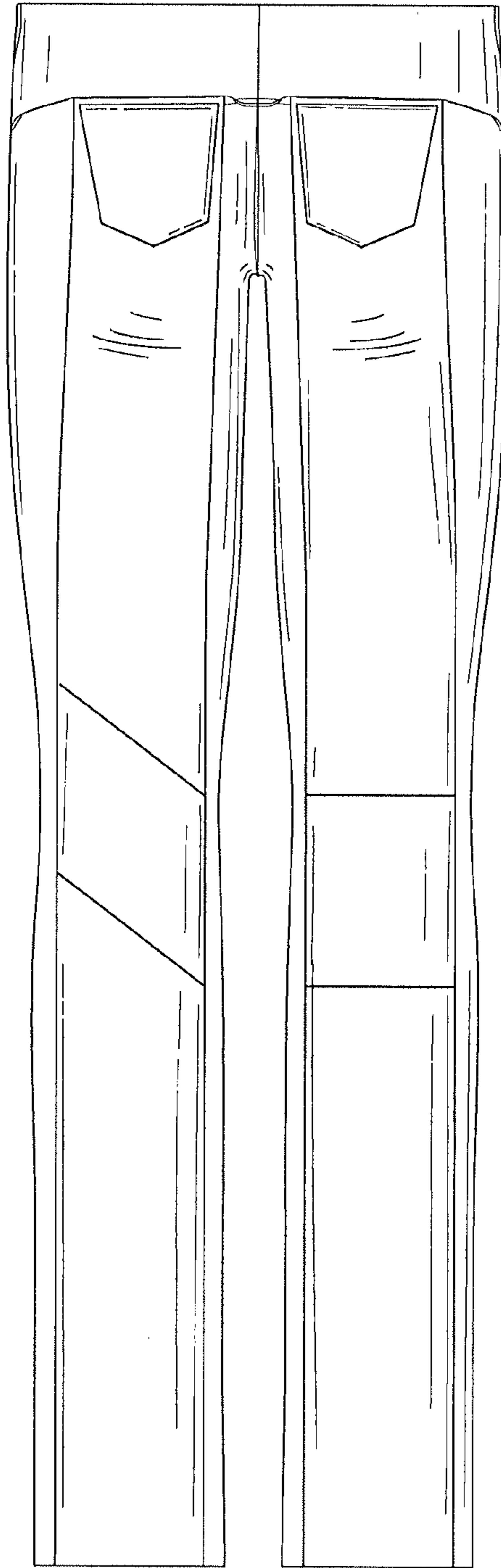

FIG. 3

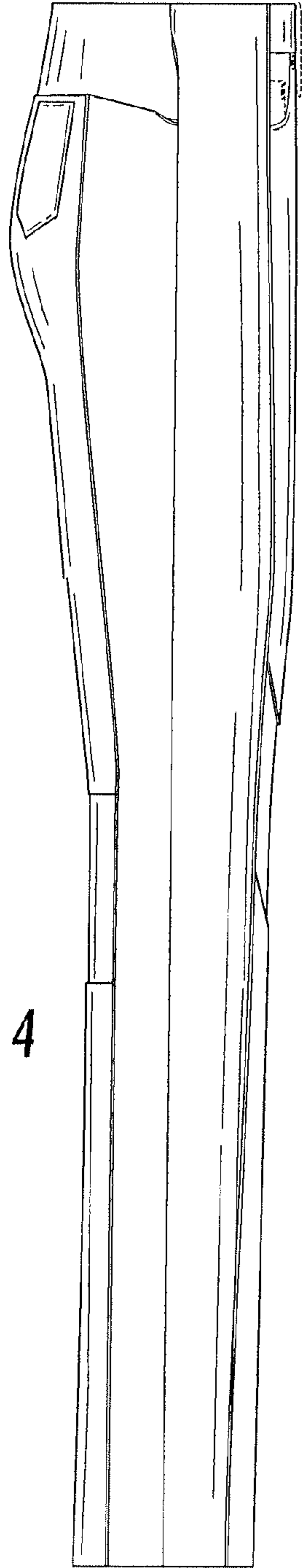

FIG. 4

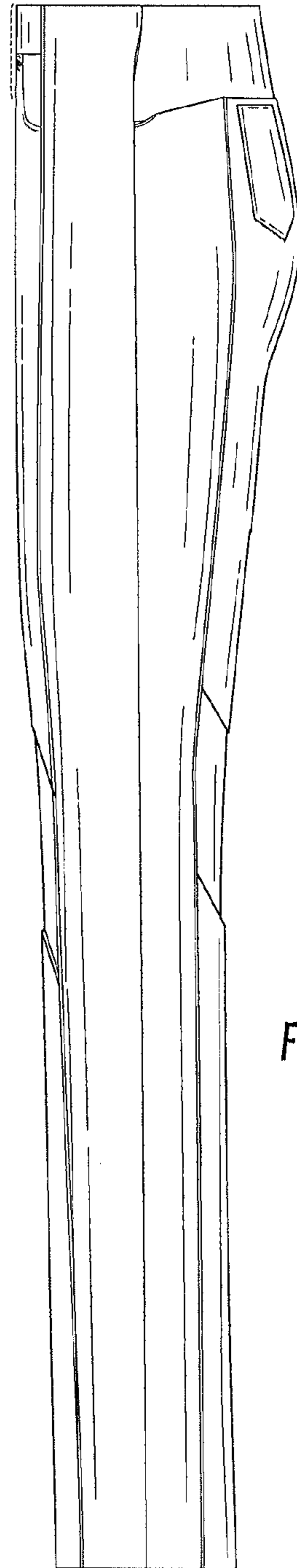
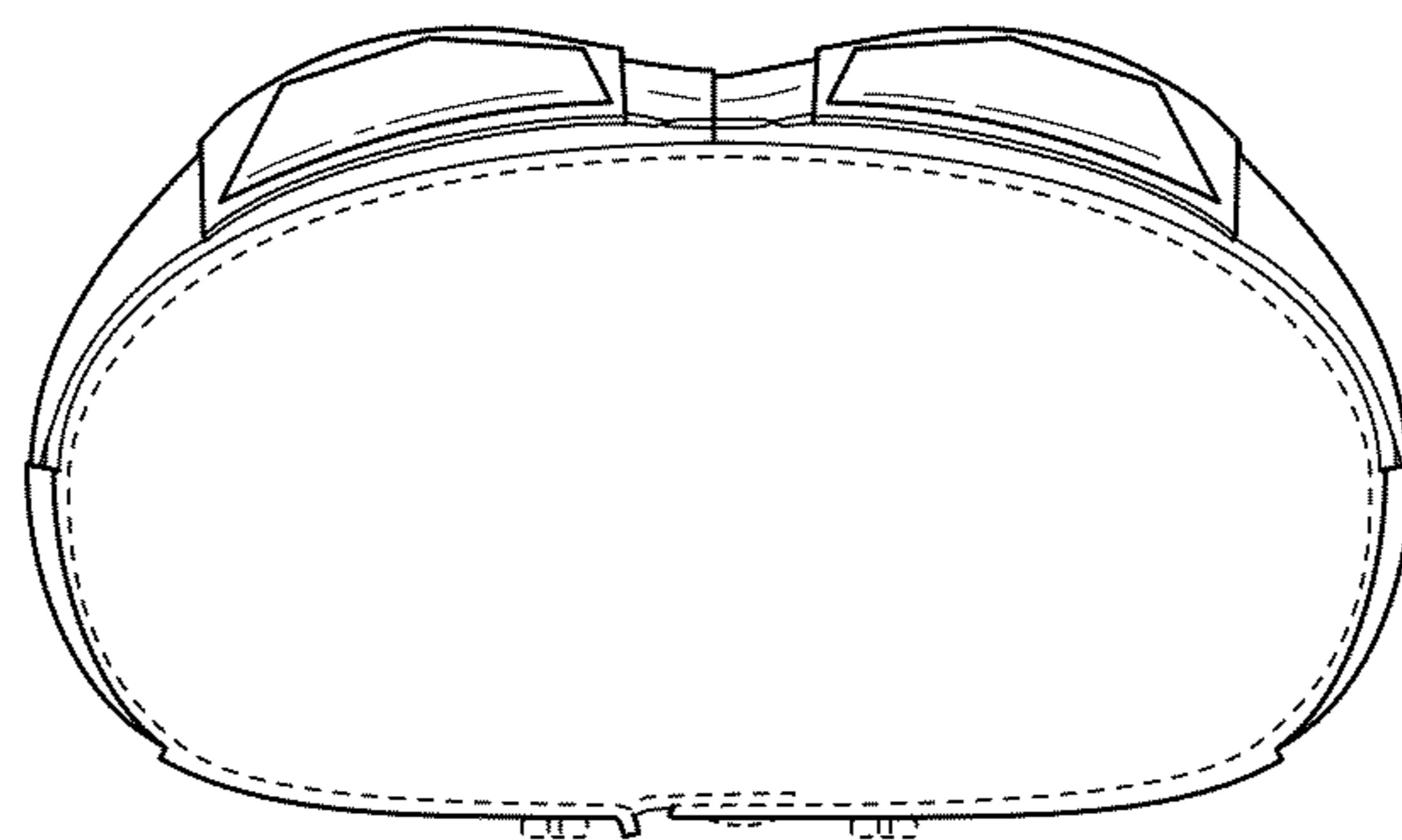
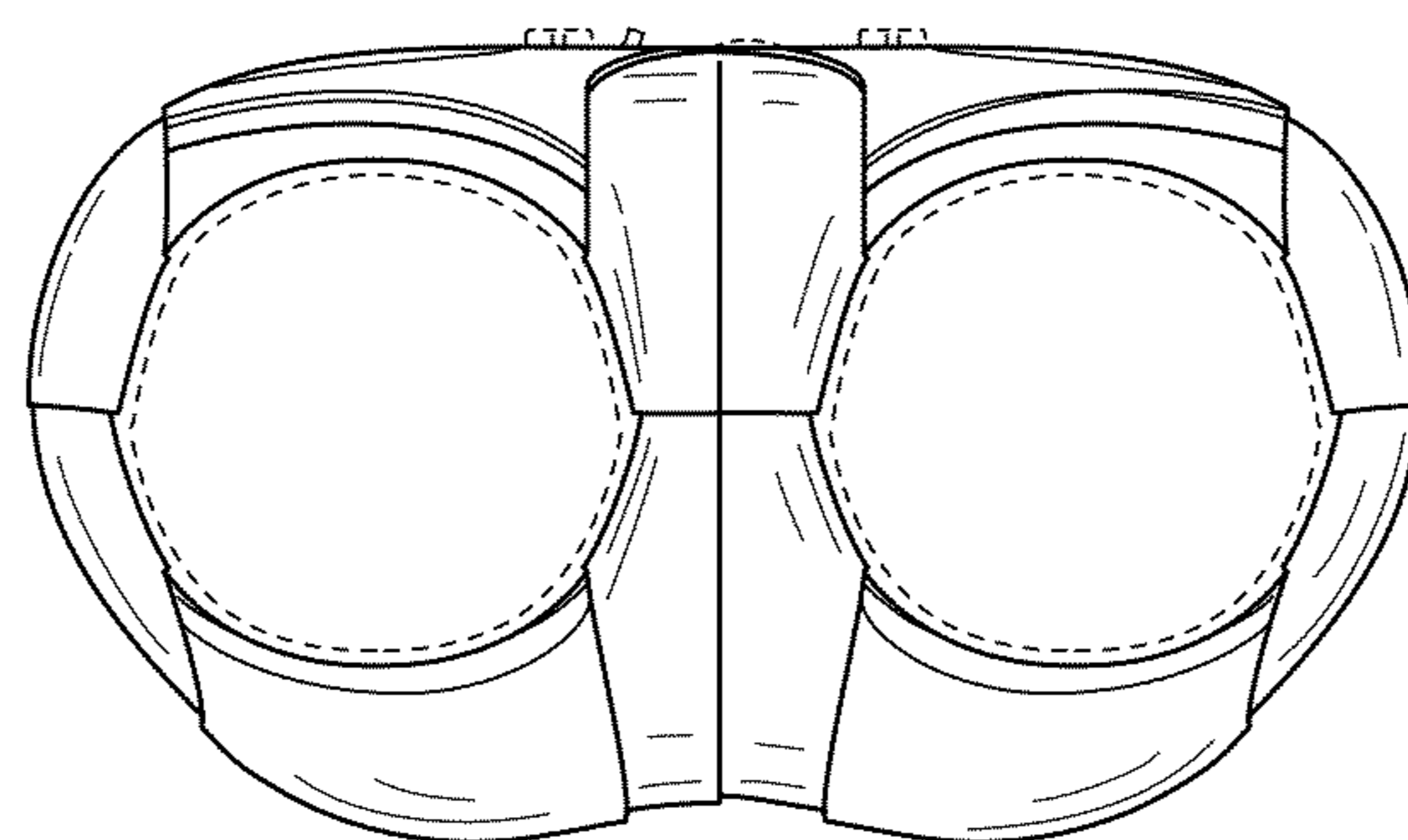

FIG. 5



**FIG. 6**



**FIG. 7**