

US00D731095S

(12) **United States Design Patent**
DeSantiago et al.

(10) **Patent No.:** **US D731,095 S**
(45) **Date of Patent:** **** Jun. 2, 2015**

(54) **HEATER LAMP**

(71) Applicants: **Arturo DeSantiago**, El Paso, TX (US);
Alfonso Barrios, Juarez (MX); **German Calvo**, Juarez (MX)

(72) Inventors: **Arturo DeSantiago**, El Paso, TX (US);
Alfonso Barrios, Juarez (MX); **German Calvo**, Juarez (MX)

(73) Assignee: **OSRAM SYLANIA Inc.**, Danvers, MA (US)

(**) Term: **14 Years**

(21) Appl. No.: **29/456,334**

(22) Filed: **May 30, 2013**

(51) **LOC (10) Cl.** **26-04**

(52) **U.S. Cl.**
USPC **D26/3**

(58) **Field of Classification Search**
USPC D26/1-4; 313/313, 315, 316, 317, 318,
313/493; 315/52, 53, 56, 57, 58
See application file for complete search history.

(56) **References Cited**

U.S. PATENT DOCUMENTS

D315,800 S * 3/1991 Hayakawa et al. D26/2
D477,885 S 7/2003 Esakoff

D506,274 S * 6/2005 Moriyama et al. D26/3
D537,547 S * 2/2007 Iida D26/3
7,441,939 B2 10/2008 Scholeno et al.
7,637,649 B2 12/2009 Garcia et al.
D636,504 S * 4/2011 Duster D26/3
7,932,665 B2 4/2011 Garcia
2013/0026904 A1 1/2013 DeSantiago et al.

* cited by examiner

Primary Examiner — Marcus Jackson

(74) *Attorney, Agent, or Firm* — Edward S. Podszus

(57) **CLAIM**

The ornamental design for a heater lamp, as shown and described.

DESCRIPTION

FIG. 1 is a perspective view of the design for a heater lamp as seen from the front, bottom;
FIG. 2 is a top plan view thereof;
FIG. 3 is a bottom plan view thereof;
FIG. 4 is a front side elevational view thereof;
FIG. 5 is a rear side elevational view thereof, being the same as in FIG. 4;
FIG. 6 is a right side elevational view thereof; and,
FIG. 7 is a left side elevational view thereof, being the same as in FIG. 6.

The broken line disclosure is for environmental purposes only and does not form a part of the claimed design.

1 Claim, 6 Drawing Sheets

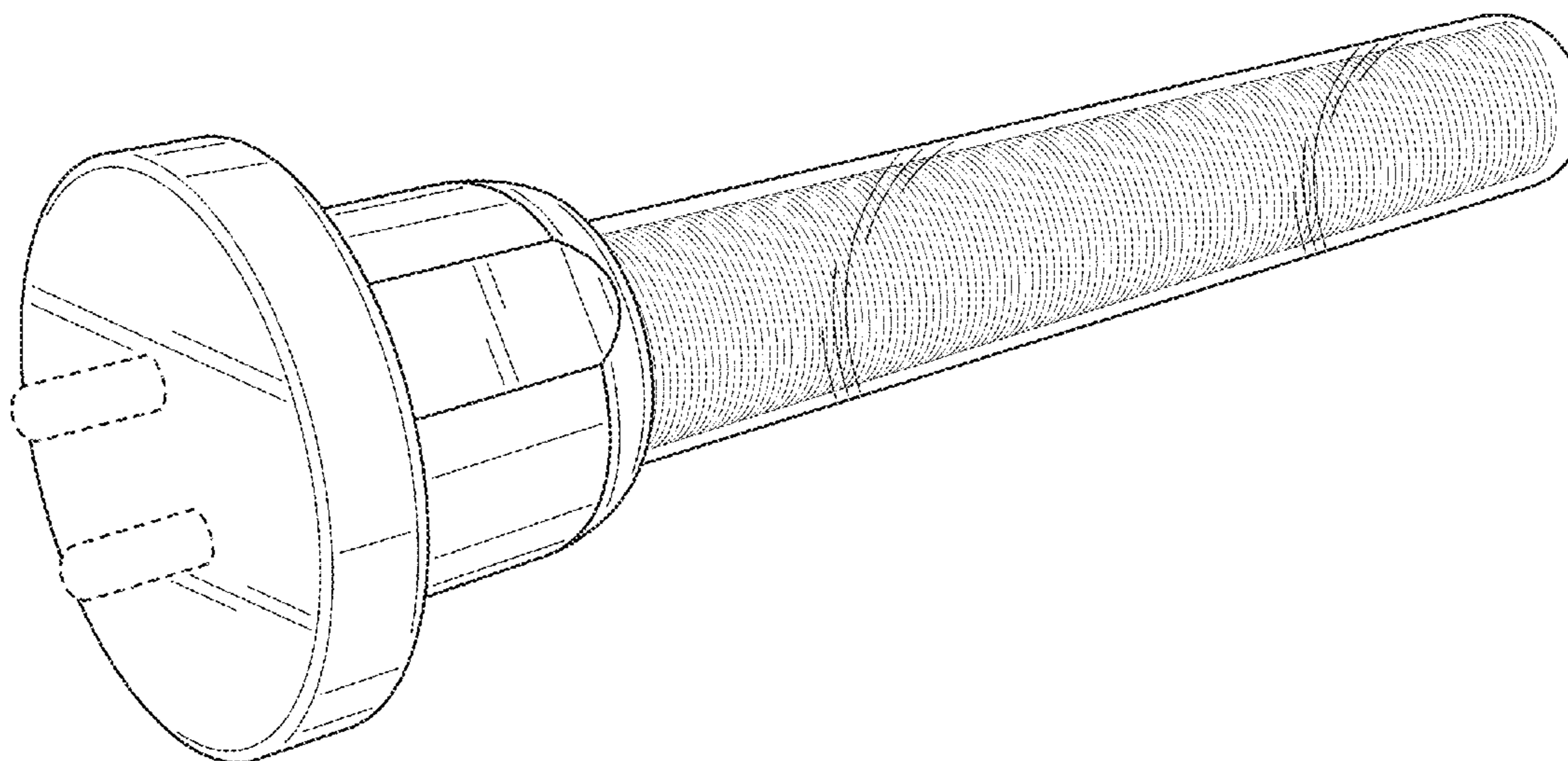

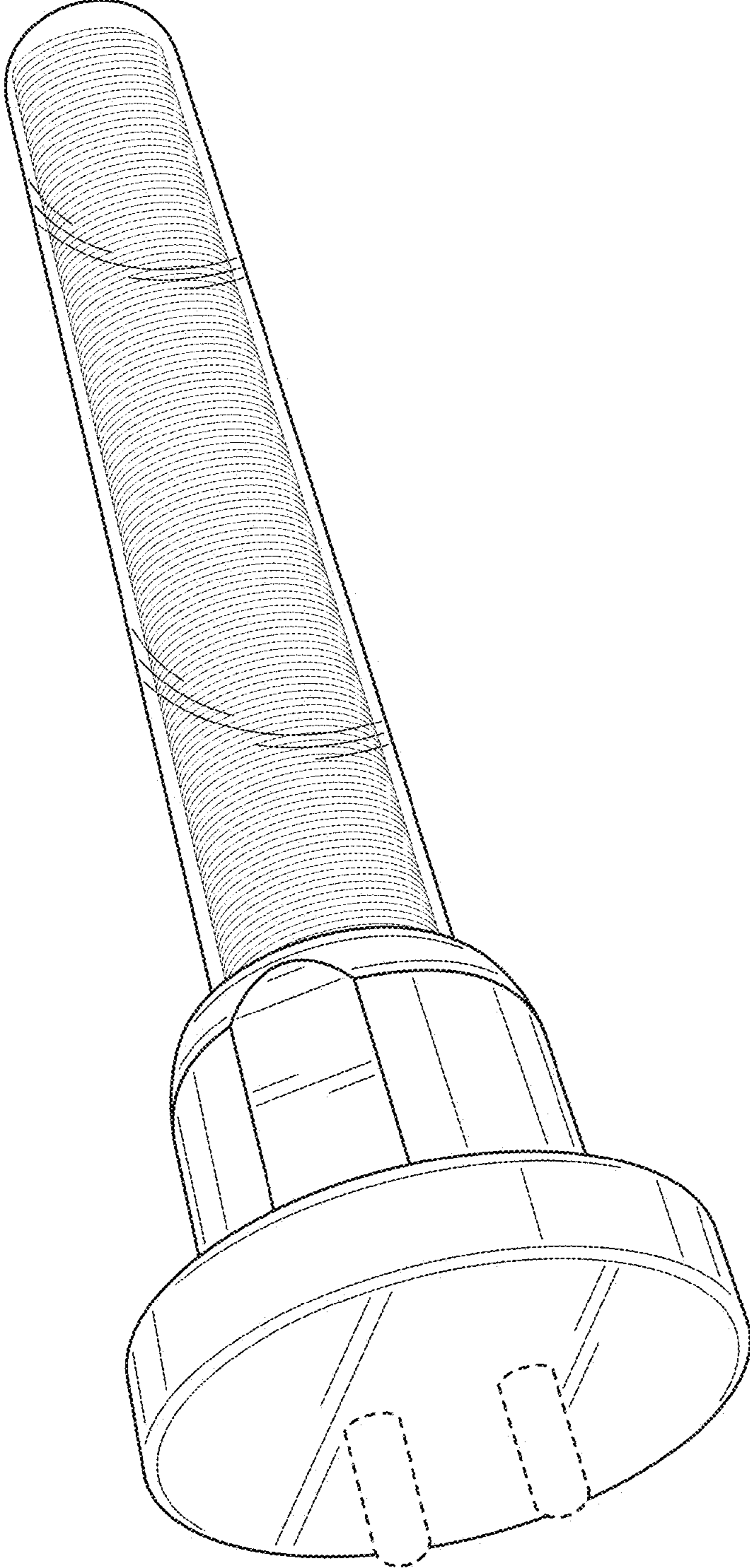

FIG. 1

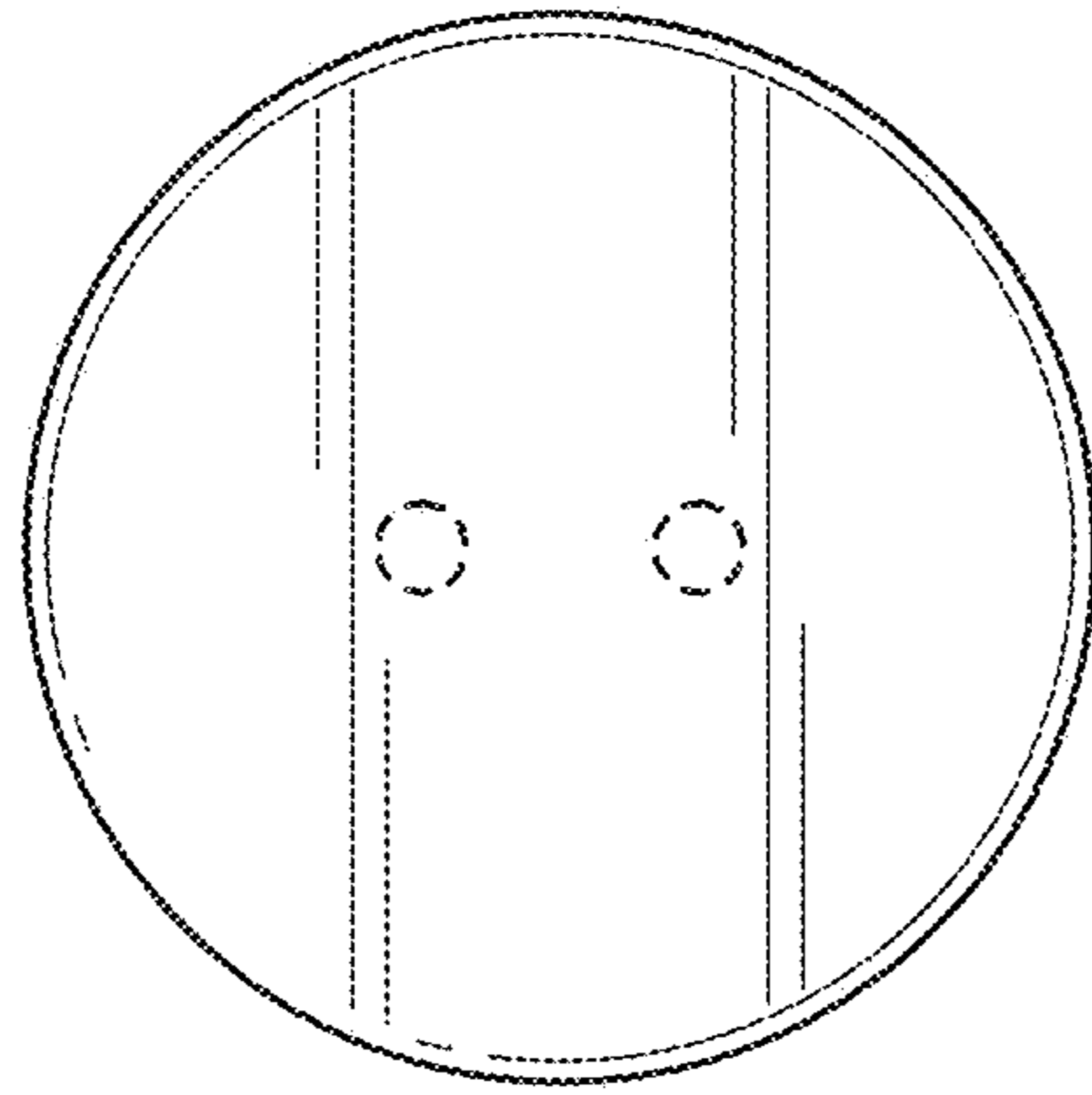

FIG. 3

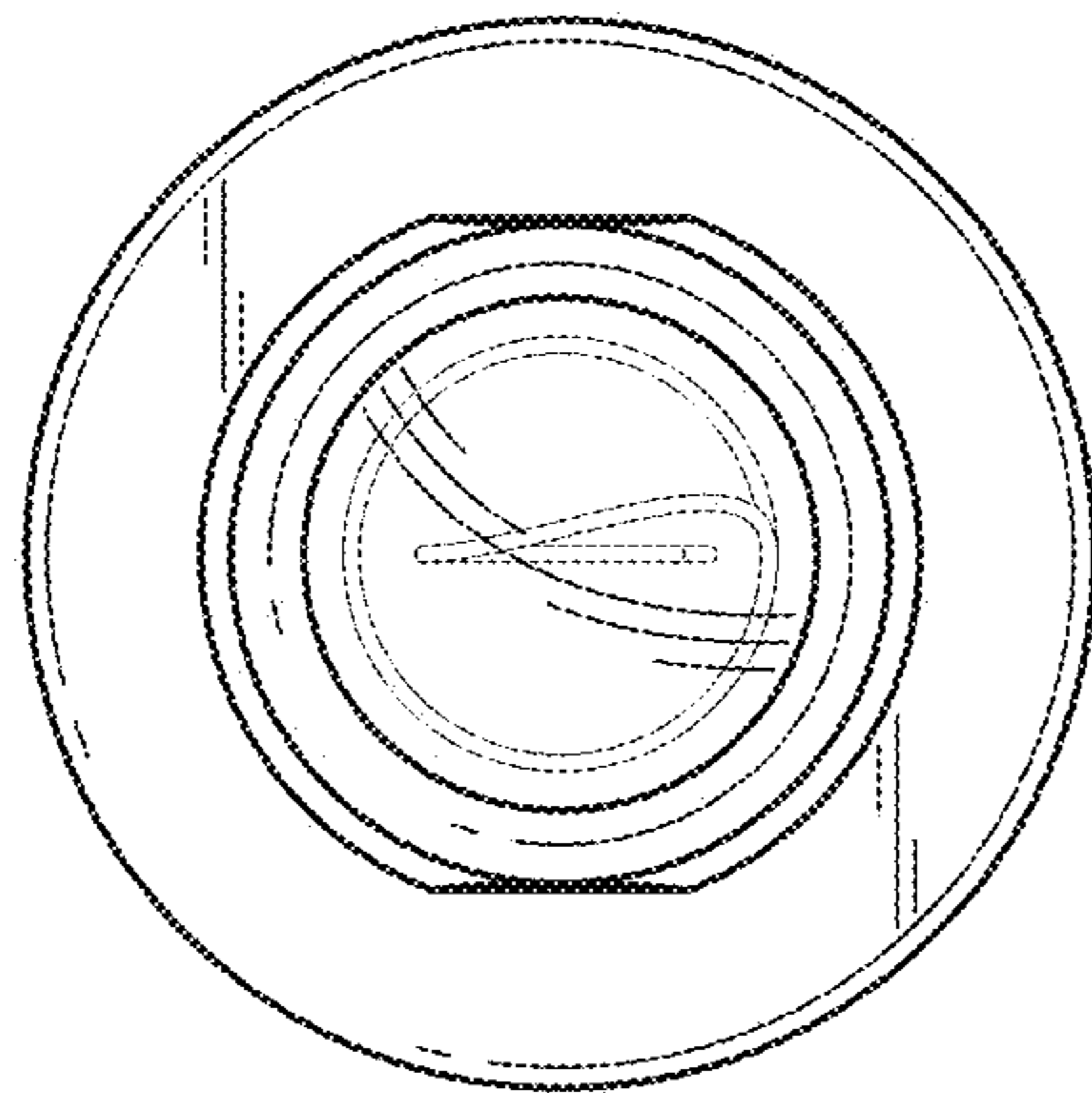

FIG. 2

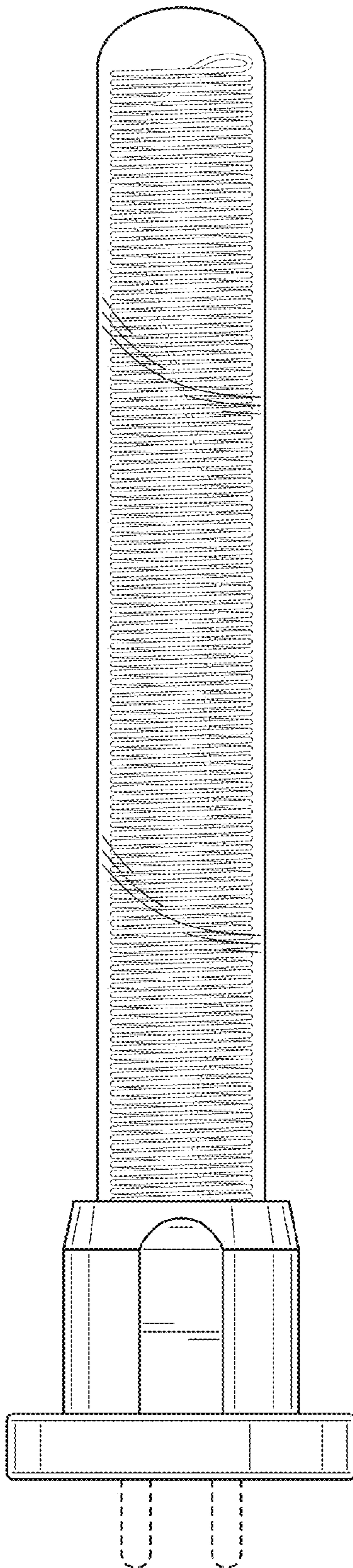

FIG. 4

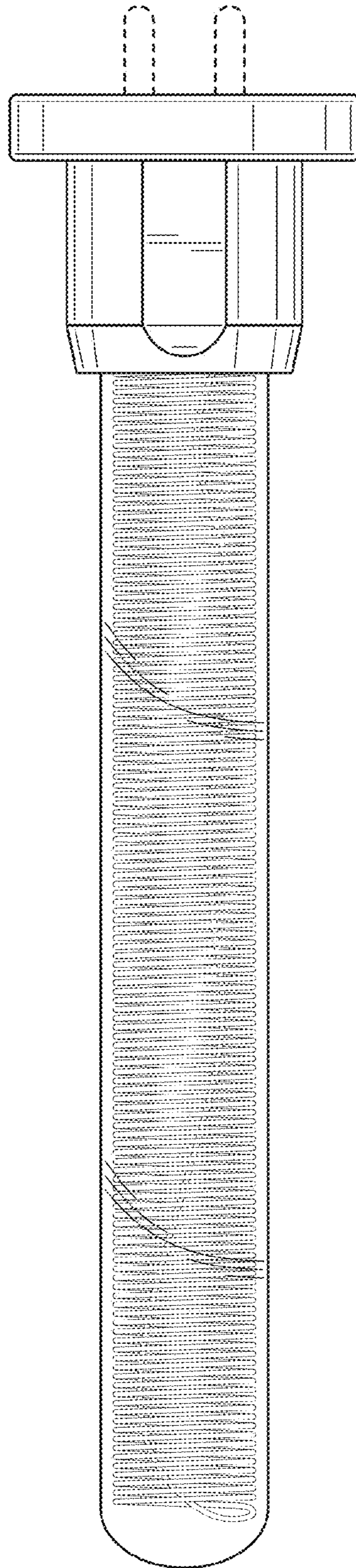

FIG. 5

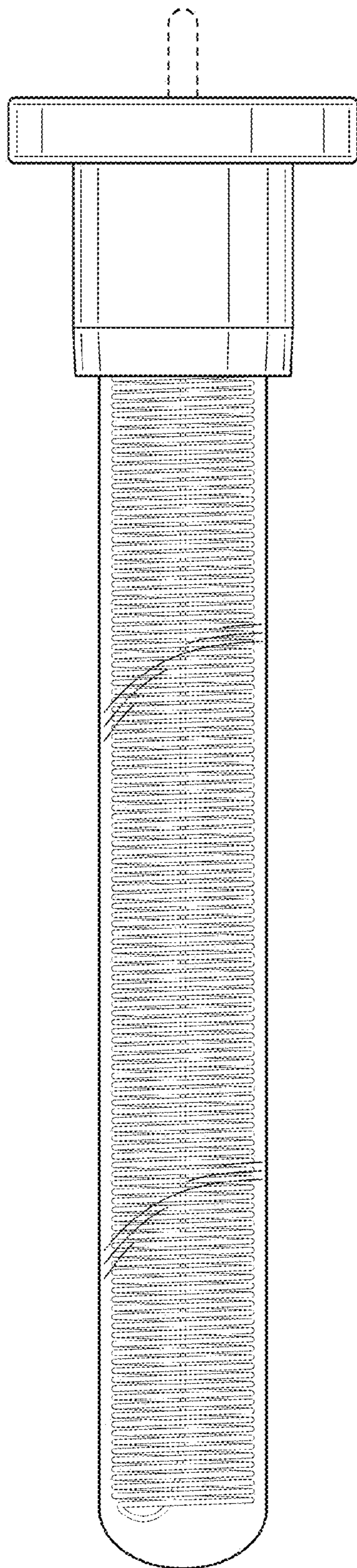

FIG. 6

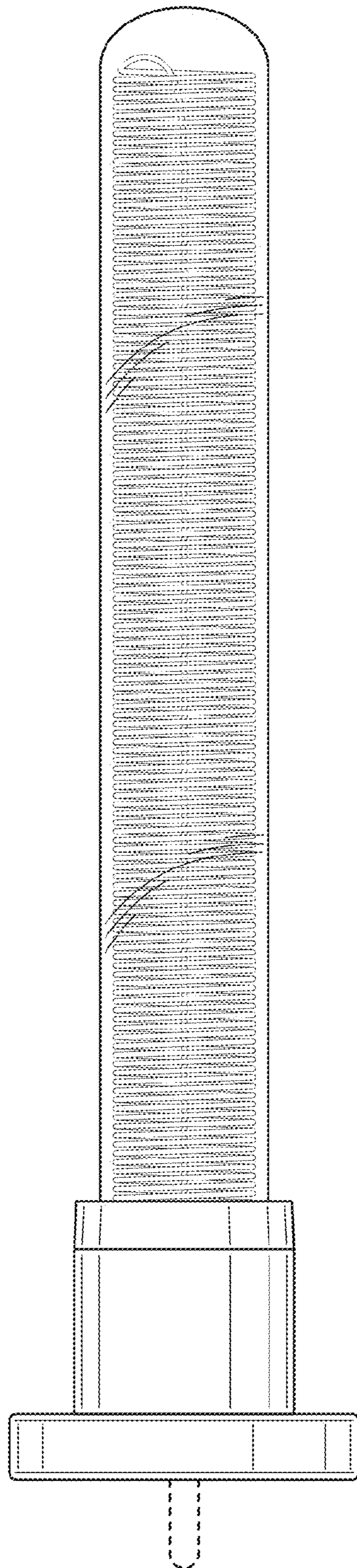

FIG. 7

UNITED STATES PATENT AND TRADEMARK OFFICE
CERTIFICATE OF CORRECTION

PATENT NO. : D731,095 S
APPLICATION NO. : 29/456334
DATED : June 2, 2015
INVENTOR(S) : Arturo DeSantiago, Alfonso Barrios and German Calvo

Page 1 of 1

It is certified that error appears in the above-identified patent and that said Letters Patent is hereby corrected as shown below:

Title page of Patent, Column 1 in the item (73) Assignee: "SYLANIA" should read --SYLVANIA--

Signed and Sealed this
First Day of December, 2015



Michelle K. Lee
Director of the United States Patent and Trademark Office