



US00D731064S

(12) **United States Design Patent**
Seto et al.

(10) **Patent No.:** **US D731,064 S**
(45) **Date of Patent:** **** Jun. 2, 2015**

(54) **IMPLANT HOUSING CONTAINER**

(75) Inventors: **Masaya Seto**, Tokyo (JP); **Reo Takanohashi**, Tokyo (JP)

(73) Assignee: **GC CORPORATION**, Tokyo (JP)

(**) Term: **14 Years**

(21) Appl. No.: **29/416,941**

(22) Filed: **Mar. 28, 2012**

(30) **Foreign Application Priority Data**

Sep. 28, 2011 (JP) 2011-022180

(51) **LOC (10) Cl.** **24-02**

(52) **U.S. Cl.**
USPC **D24/156**

(58) **Field of Classification Search**
USPC D24/155, 156, 224; 206/438, 63.5, 570,
206/339; 433/174; D9/500, 503-505, 516,
D9/556, 558, 538

See application file for complete search history.

(56) **References Cited**

U.S. PATENT DOCUMENTS

5,368,160	A *	11/1994	Leuschen et al.	206/339
5,558,230	A *	9/1996	Fischer et al.	206/570
D616,548	S *	5/2010	Fares et al.	D24/156
7,921,991	B2 *	4/2011	Sato et al.	206/63.5
8,083,054	B2 *	12/2011	Nihei et al.	206/63.5
D659,829	S *	5/2012	Nihei et al.	D24/156
8,292,075	B2 *	10/2012	Liao et al.	206/438
2004/0112781	A1 *	6/2004	Hofverberg et al.	206/438
2007/0295620	A1 *	12/2007	Collet et al.	206/63.5
2008/0261177	A1 *	10/2008	Ford et al.	433/174

2010/0227294	A1 *	9/2010	Takagi et al.	433/174
2010/0236947	A1 *	9/2010	Liao et al.	206/63.5
2010/0243485	A1 *	9/2010	Sato et al.	206/63.5

* cited by examiner

Primary Examiner — Ian Simmons

Assistant Examiner — Charles Hanson

(74) *Attorney, Agent, or Firm* — Oblon, McClelland, Maier & Neustadt, L.L.P.

(57) **CLAIM**

The ornamental design for an implant housing container, as shown and described.

DESCRIPTION

FIG. 1 is a front view of an implant housing container;
 FIG. 2 is a rear view thereof;
 FIG. 3 is a left side view thereof;
 FIG. 4 is a right side view thereof;
 FIG. 5 is a top plan view thereof;
 FIG. 6 is a bottom plan view thereof;
 FIG. 7 is a front, bottom perspective view thereof;
 FIG. 8 is a front view thereof, showing the lid removed from the main body;
 FIG. 9 is a top plan view thereof, showing only the main body;
 FIG. 10 is a bottom plan view thereof, showing only the lid;
 FIG. 11 is a front, bottom perspective view thereof, showing a dental implant housed in the container;
 FIG. 12 is an enlarged cross-sectional view of line 12-12 from FIG. 10; and,
 FIG. 13 is an enlarged cross-sectional view of line 13-13 from FIG. 10.

The broken lines in the drawings depict environmental subject matter only and form no part of the claimed design.

1 Claim, 7 Drawing Sheets

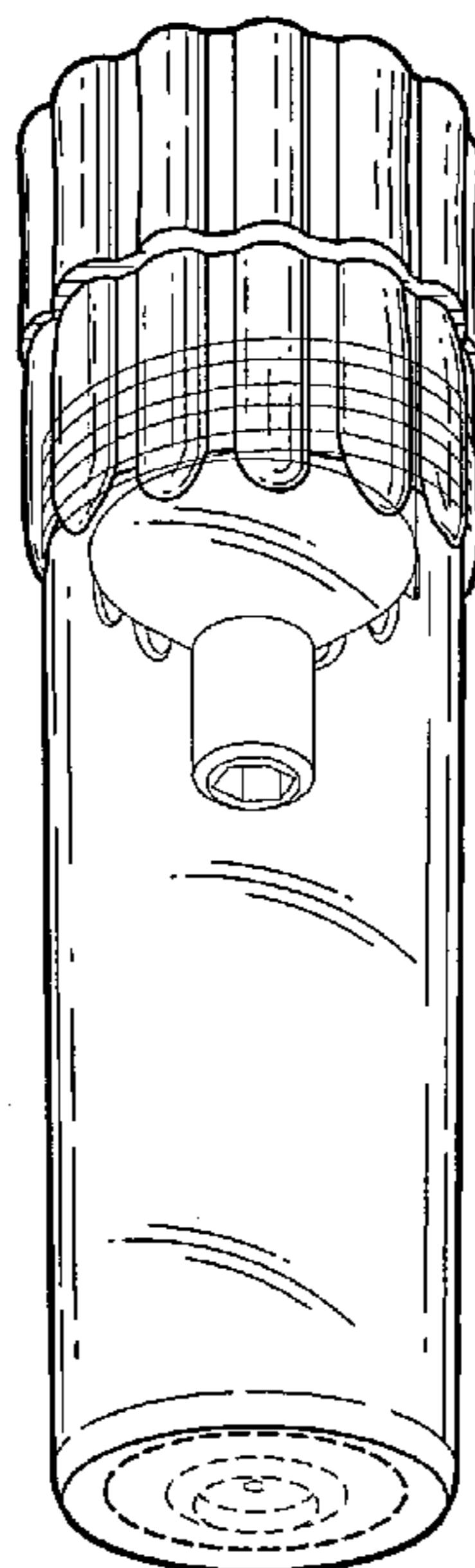

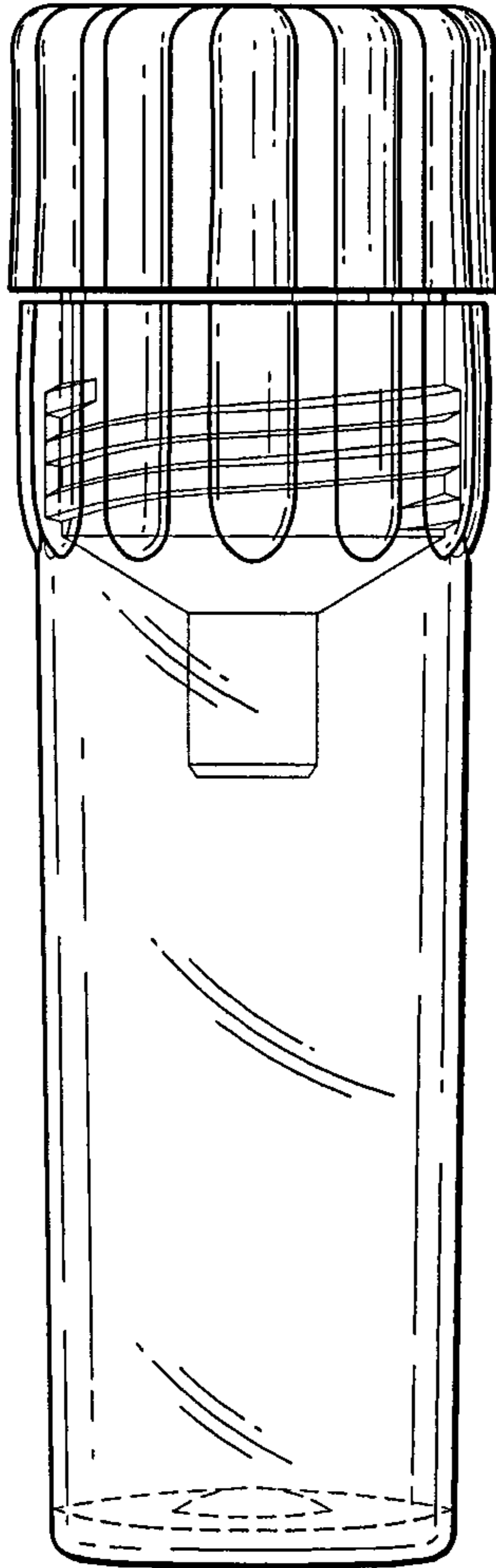

Fig. 1

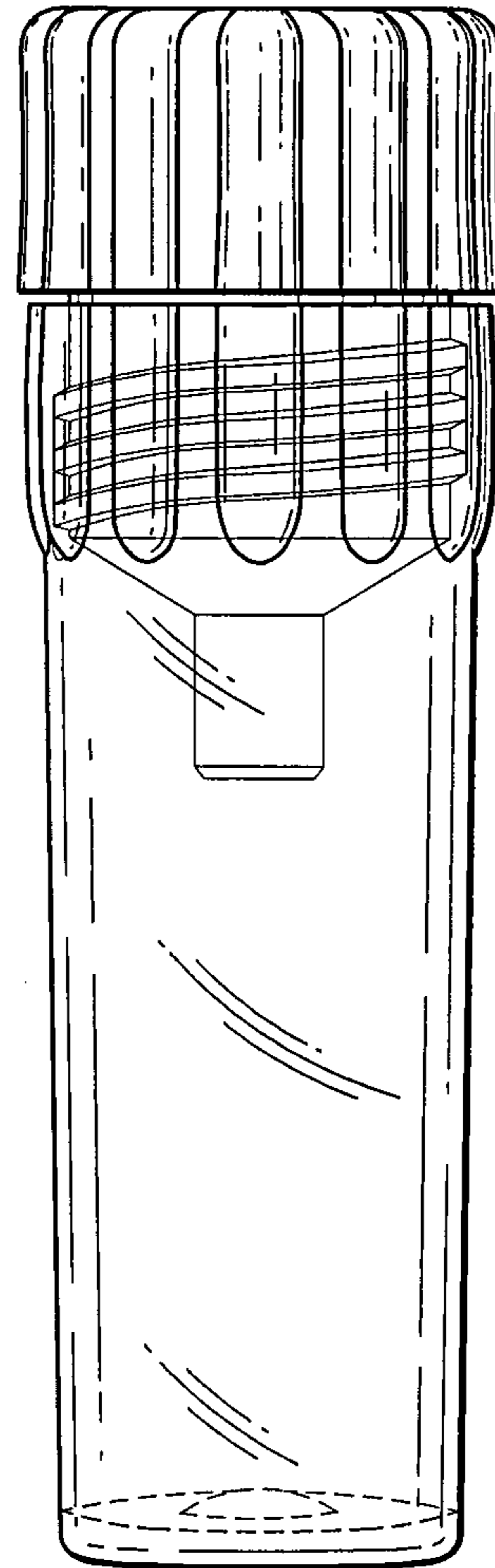

Fig. 2

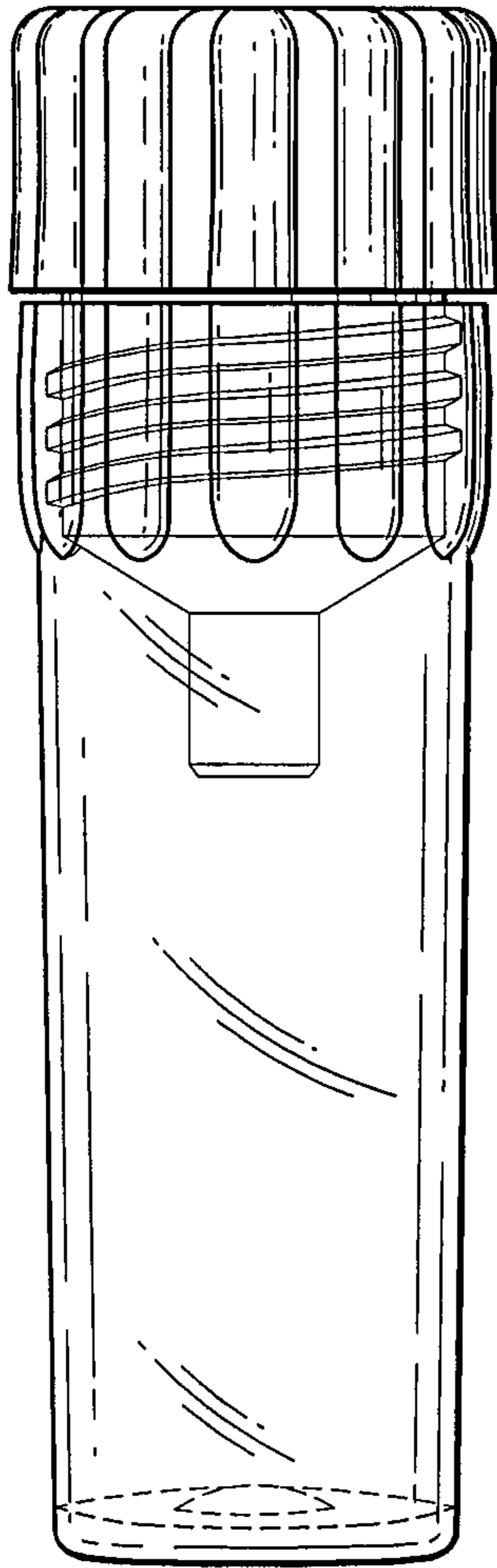

Fig. 3

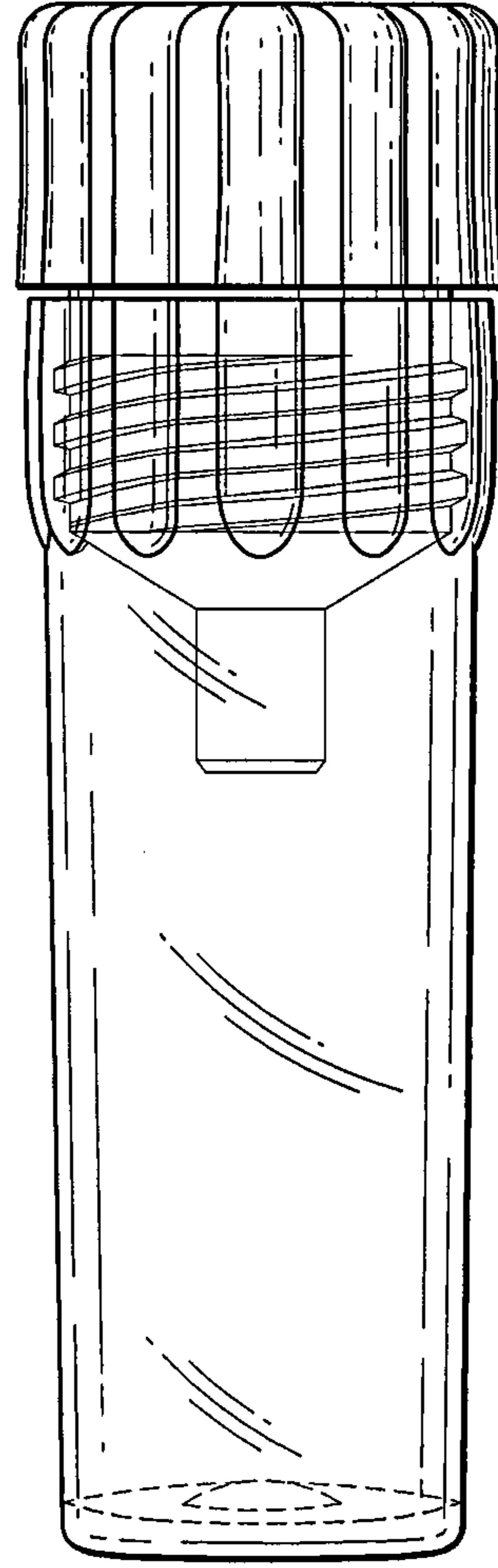

Fig. 4

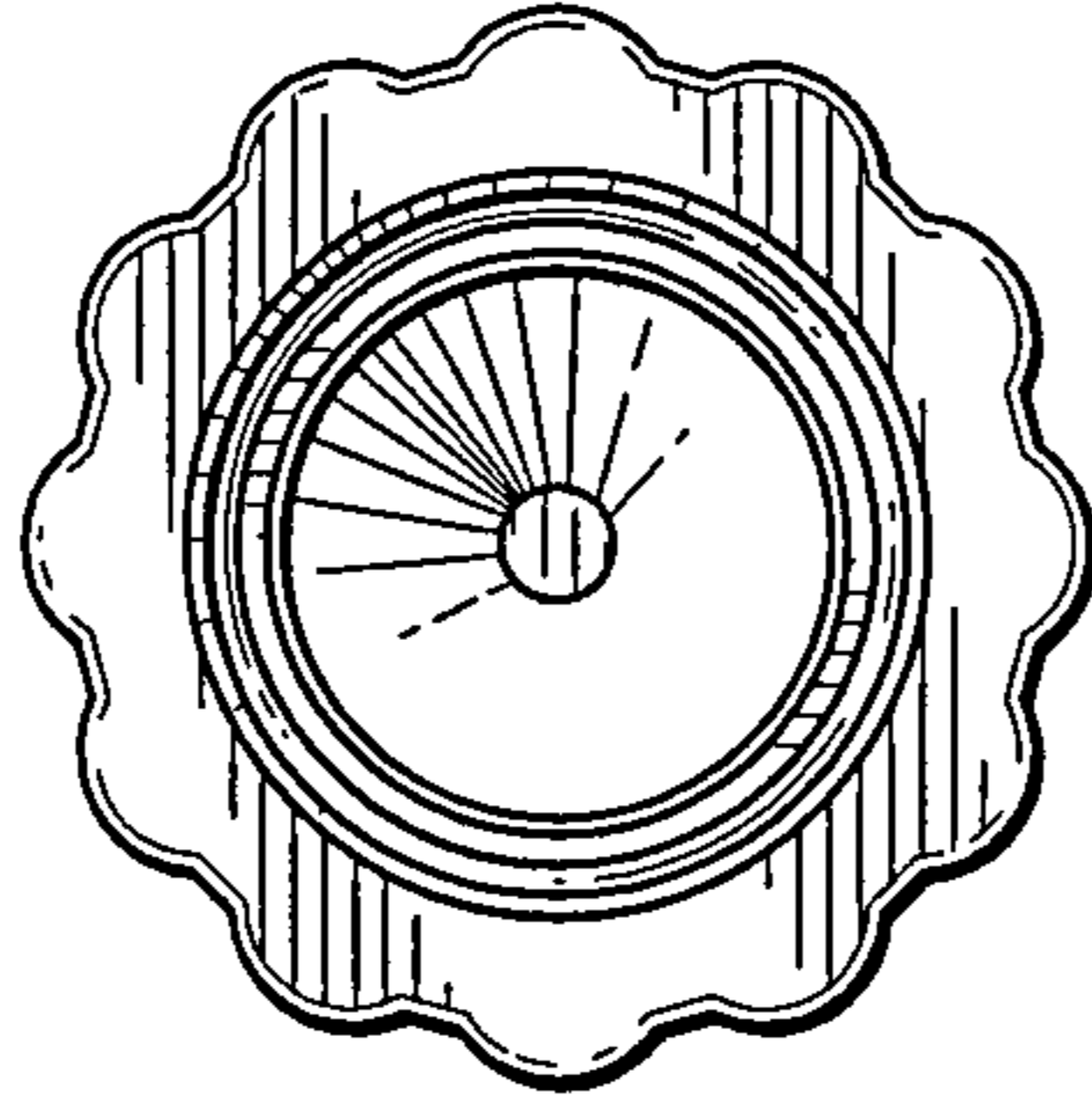

Fig. 5

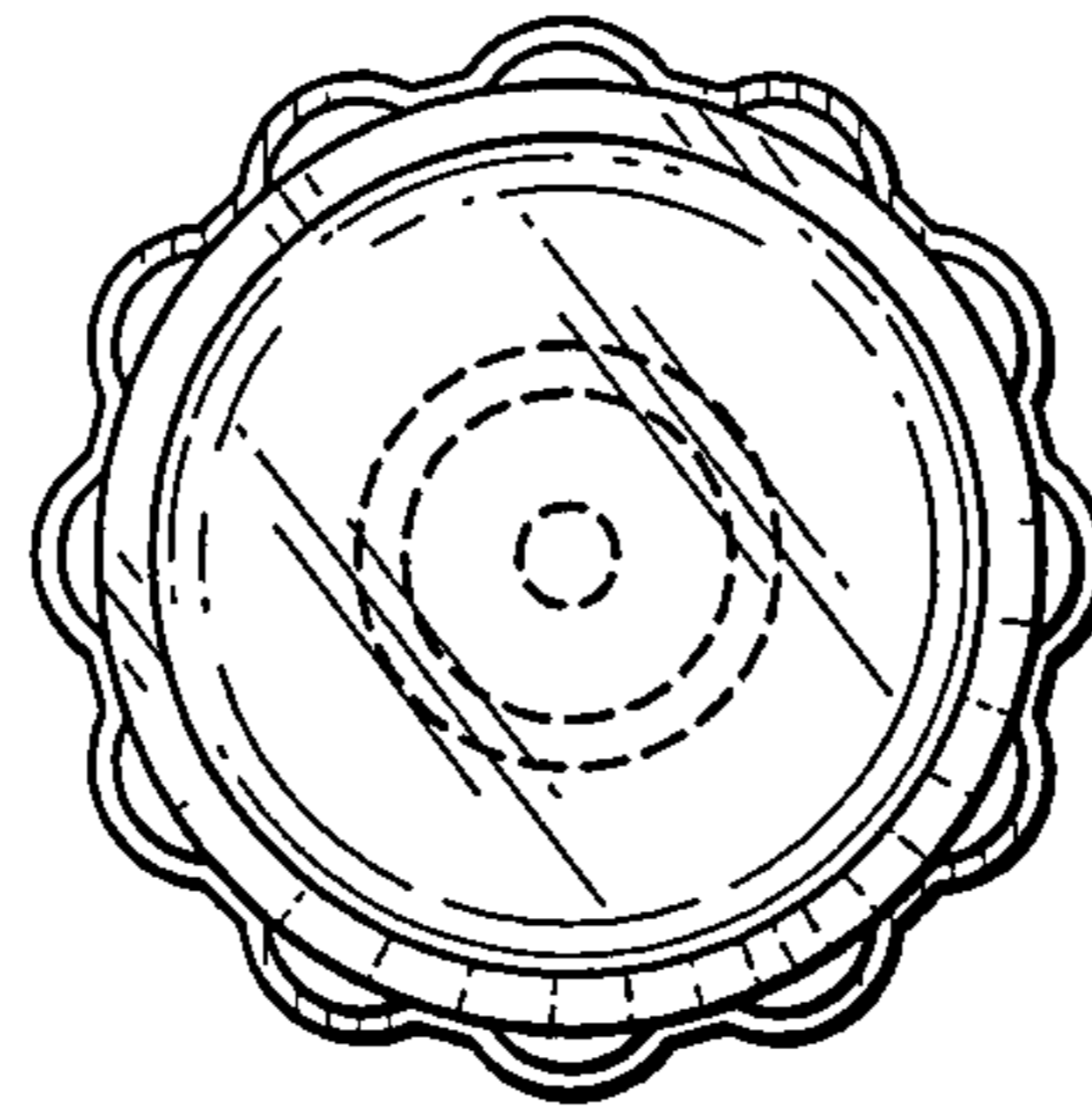

Fig. 6

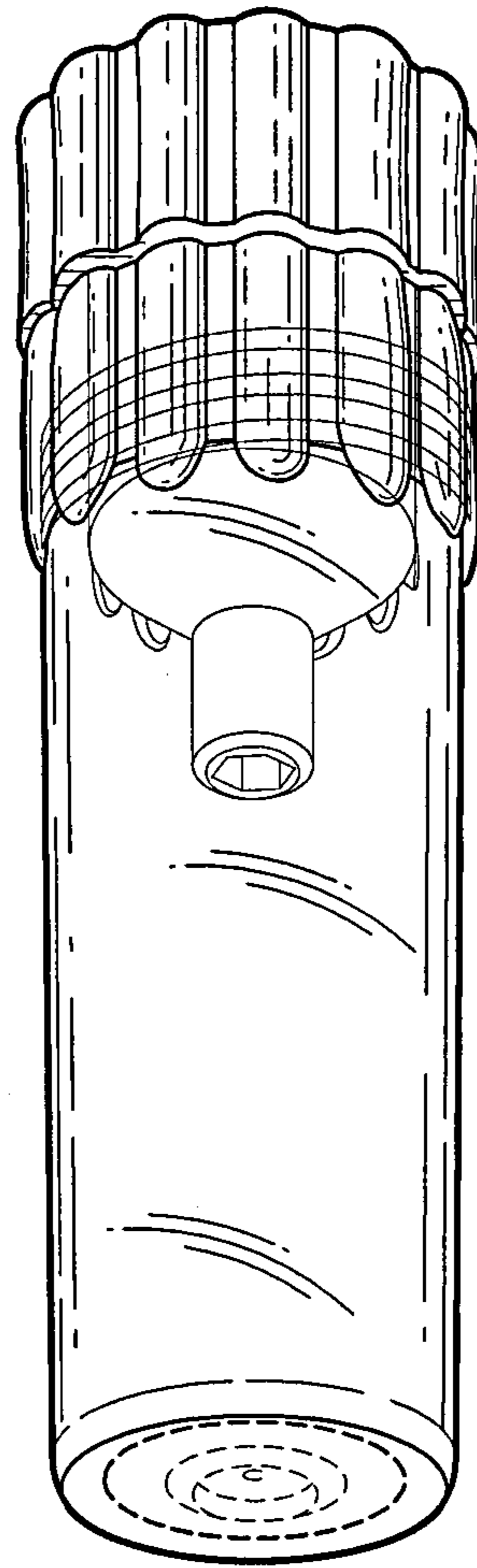

Fig. 7

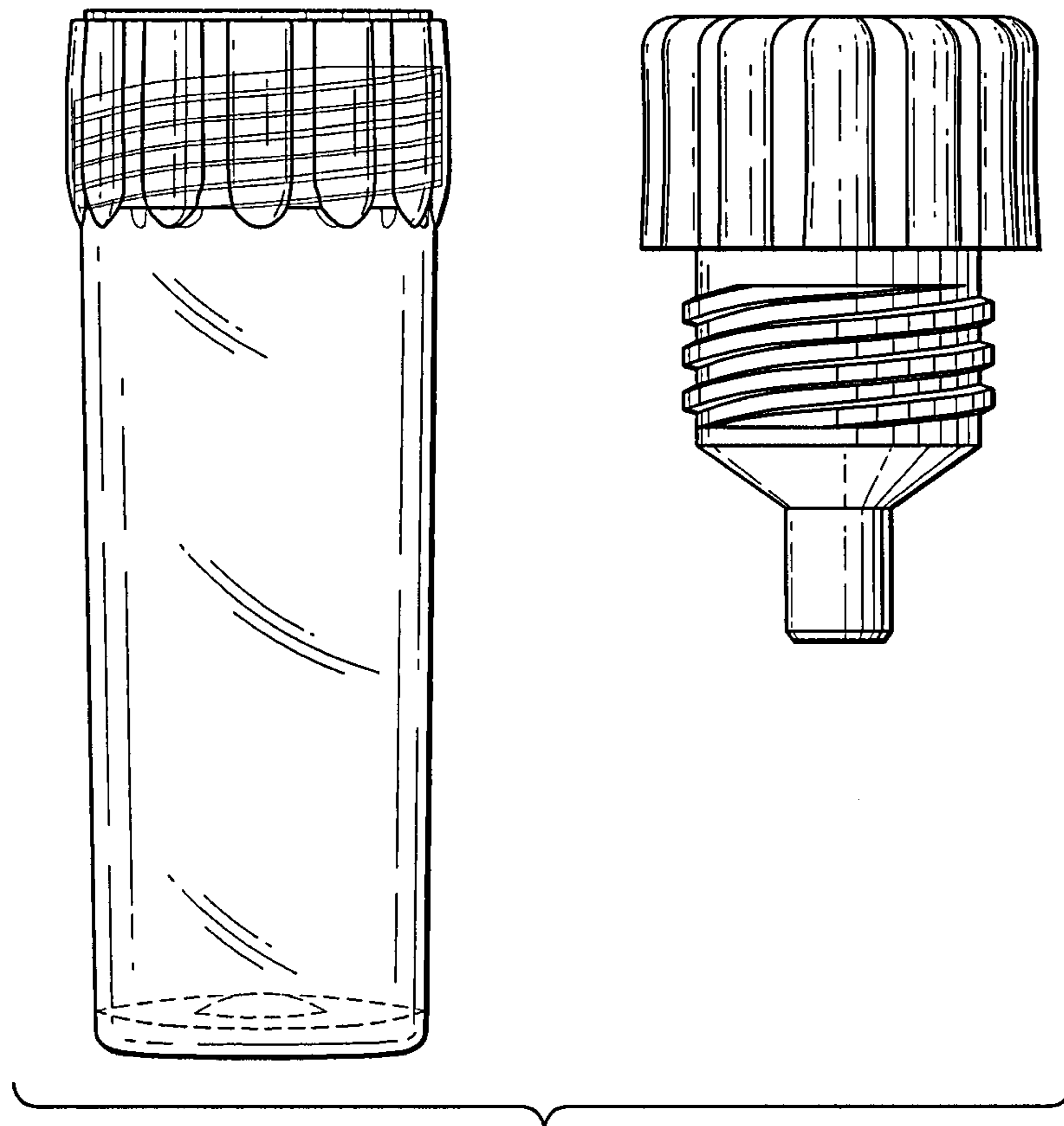

Fig. 8

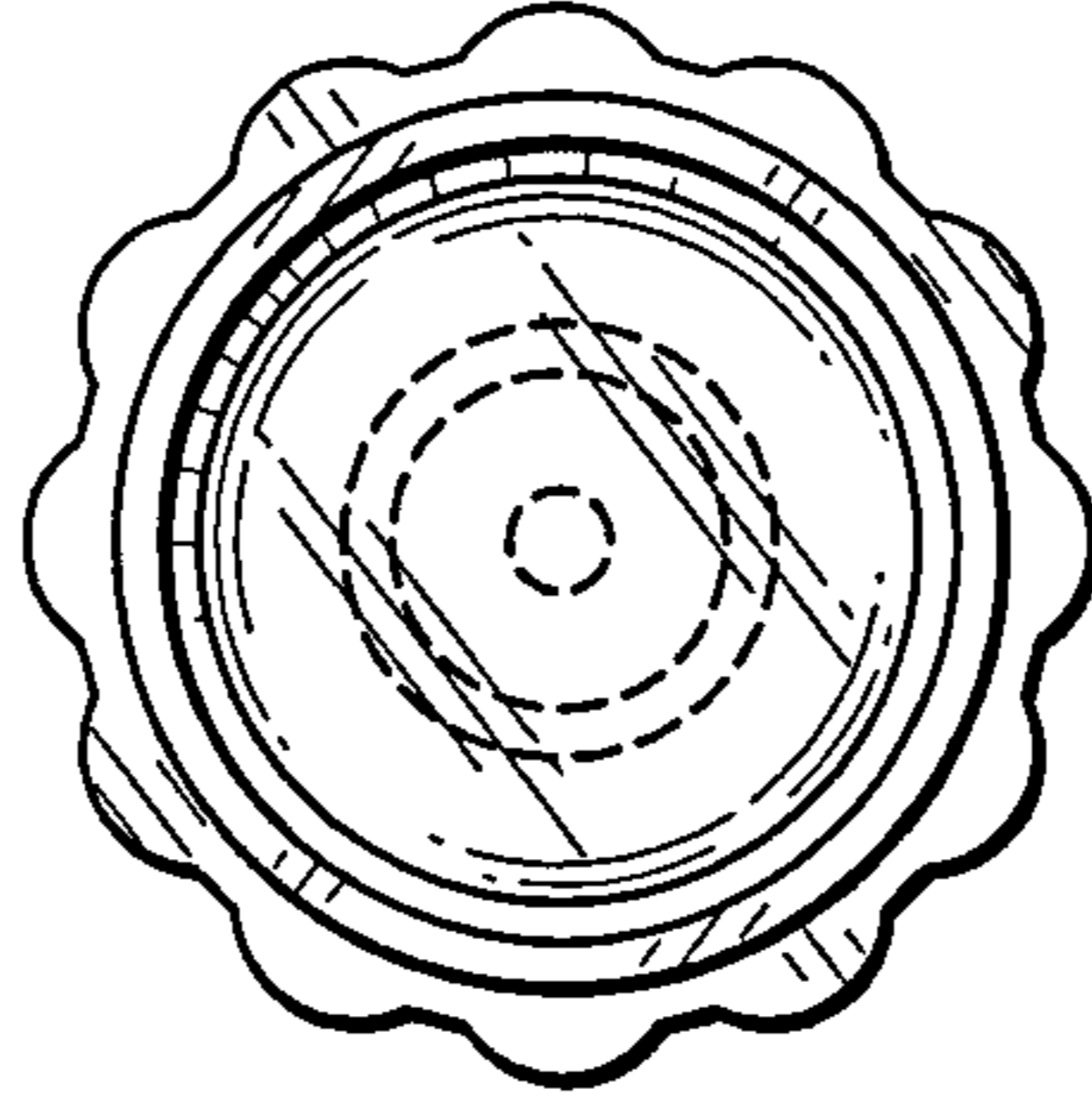

Fig. 9

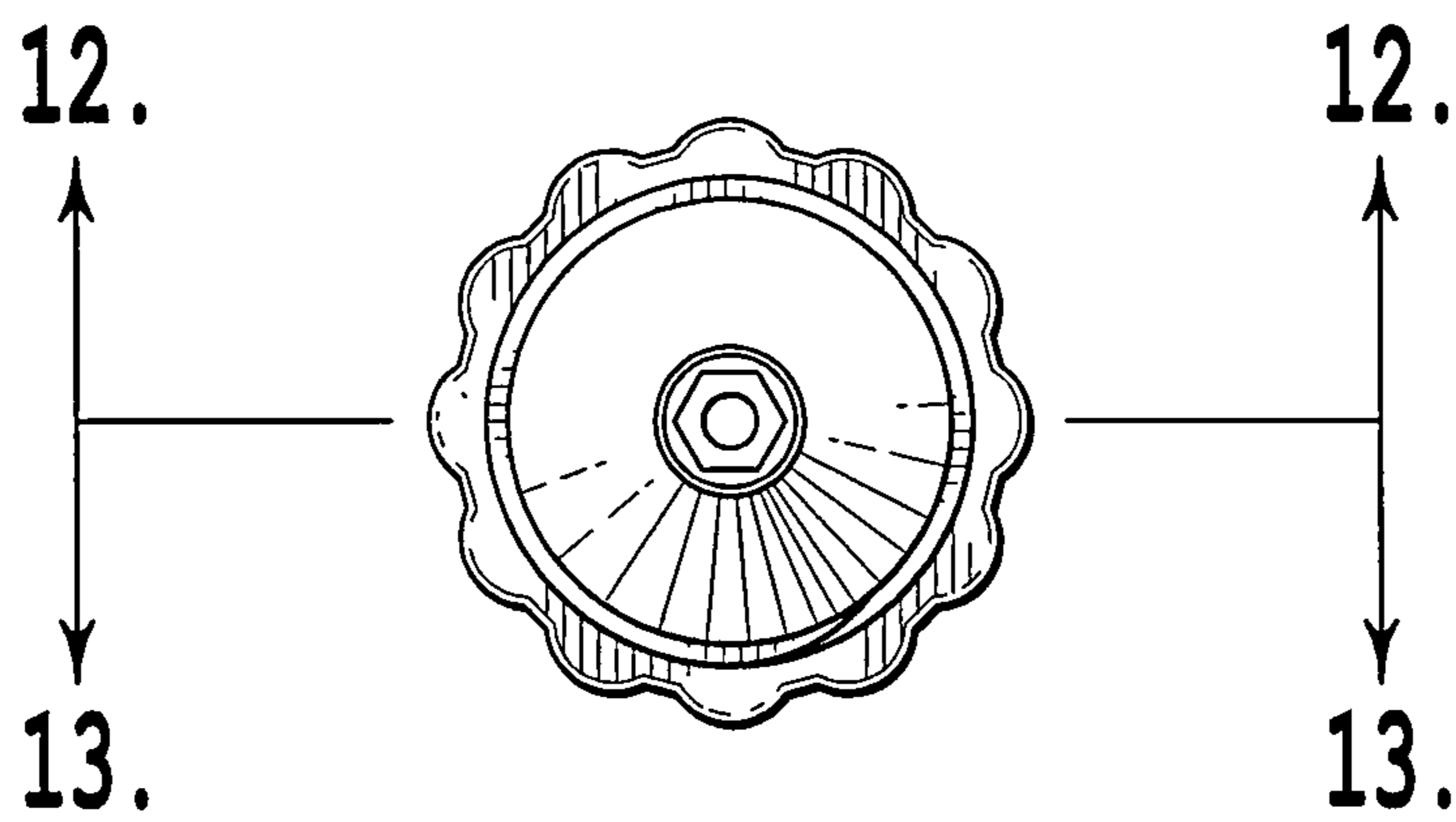

Fig. 10

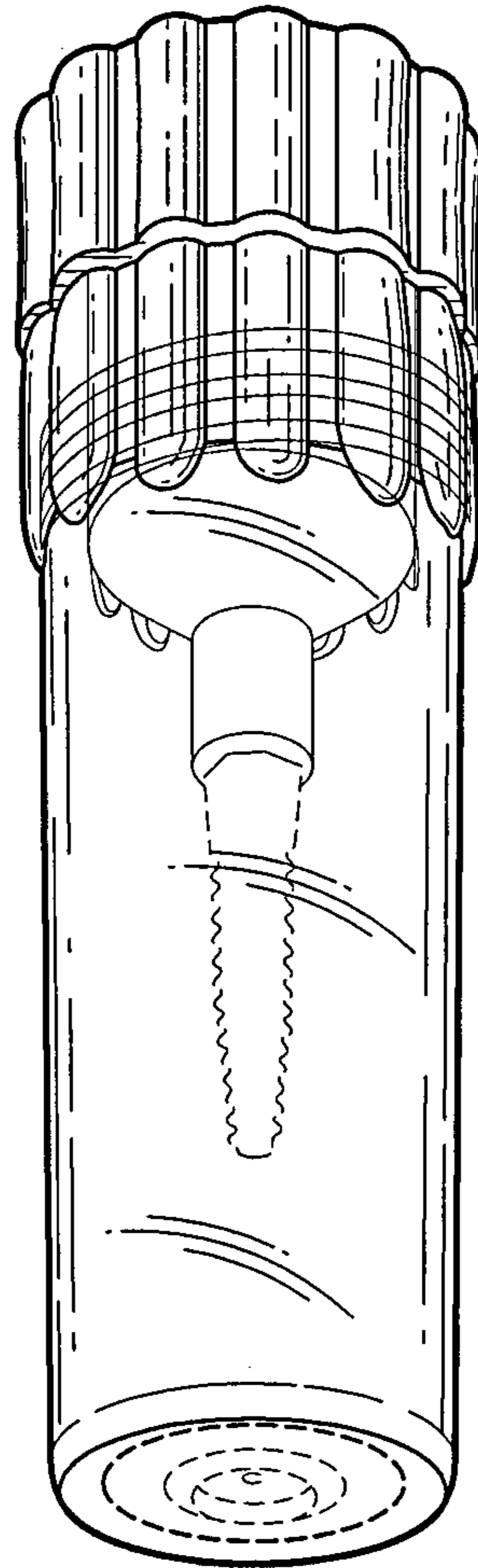

Fig. 11