



US00D731044S

(12) **United States Design Patent**  
**Fulkerson et al.**

(10) **Patent No.:** **US D731,044 S**  
(45) **Date of Patent:** **\*\* Jun. 2, 2015**

(54) **CONTROL ELEMENT**

(75) Inventors: **Gary Fulkerson**, White Lake, MI (US);  
**Rolf Haag**, Fenton, MI (US); **Robert Gaarder**, West Bloomfield, MI (US);  
**Mark Hickey**, Howell, MI (US); **Sead Smailagic**, Auburn Hills, MI (US);  
**Albrecht Otte**, Brighton, MI (US)

(73) Assignee: **WEBASTO SE**, Stockdorf/Gauting (DE)

(\*\*) Term: **14 Years**

(21) Appl. No.: **29/428,343**

(22) Filed: **Jul. 30, 2012**

(51) **LOC (10) Cl.** ..... **12-16**

(52) **U.S. Cl.**  
USPC ..... **D23/324**

(58) **Field of Classification Search**  
USPC ..... D23/314, 324, 325, 326, 327; D10/50,  
D10/49, 60, 103; D14/247, 258; D13/184;  
D12/174, 400, 192; 361/694, 690;  
236/1 C, 49.3; 62/131, 129; 165/204,  
165/202; 345/173; 362/23.18; 219/208;  
701/36

See application file for complete search history.

(56) **References Cited**

**U.S. PATENT DOCUMENTS**

D218,009 S \* 7/1970 Bosack ..... D8/312  
D377,909 S \* 2/1997 Smith ..... D10/50

D503,631 S \* 4/2005 Peabody ..... D10/50  
D588,479 S \* 3/2009 Giese ..... D10/50  
D679,789 S \* 4/2013 Thao et al. .... D23/324

\* cited by examiner

*Primary Examiner* — T. Chase Nelson

*Assistant Examiner* — Ania Aman

(74) *Attorney, Agent, or Firm* — Fitch, Even, Tabin & Flannery LLP

(57) **CLAIM**

We claim the ornamental design for a control element, substantially as shown and described.

**DESCRIPTION**

FIG. 1 is a front perspective view of a control element showing our new design;  
FIG. 2 is a front elevation view of the control element of FIG. 1;  
FIG. 3 is a top plan view of the control element of FIG. 1;  
FIG. 4 is a bottom plan view of the control element of FIG. 1;  
FIG. 5 is a left side elevation view of the control element of FIG. 1;  
FIG. 6 is a right side elevation view of the control element of FIG. 1; and,  
FIG. 7 is a back elevation view of the control element of FIG. 1.  
The broken lines depict unclaimed environmental subject matter and form no part of the claimed design.

**1 Claim, 7 Drawing Sheets**

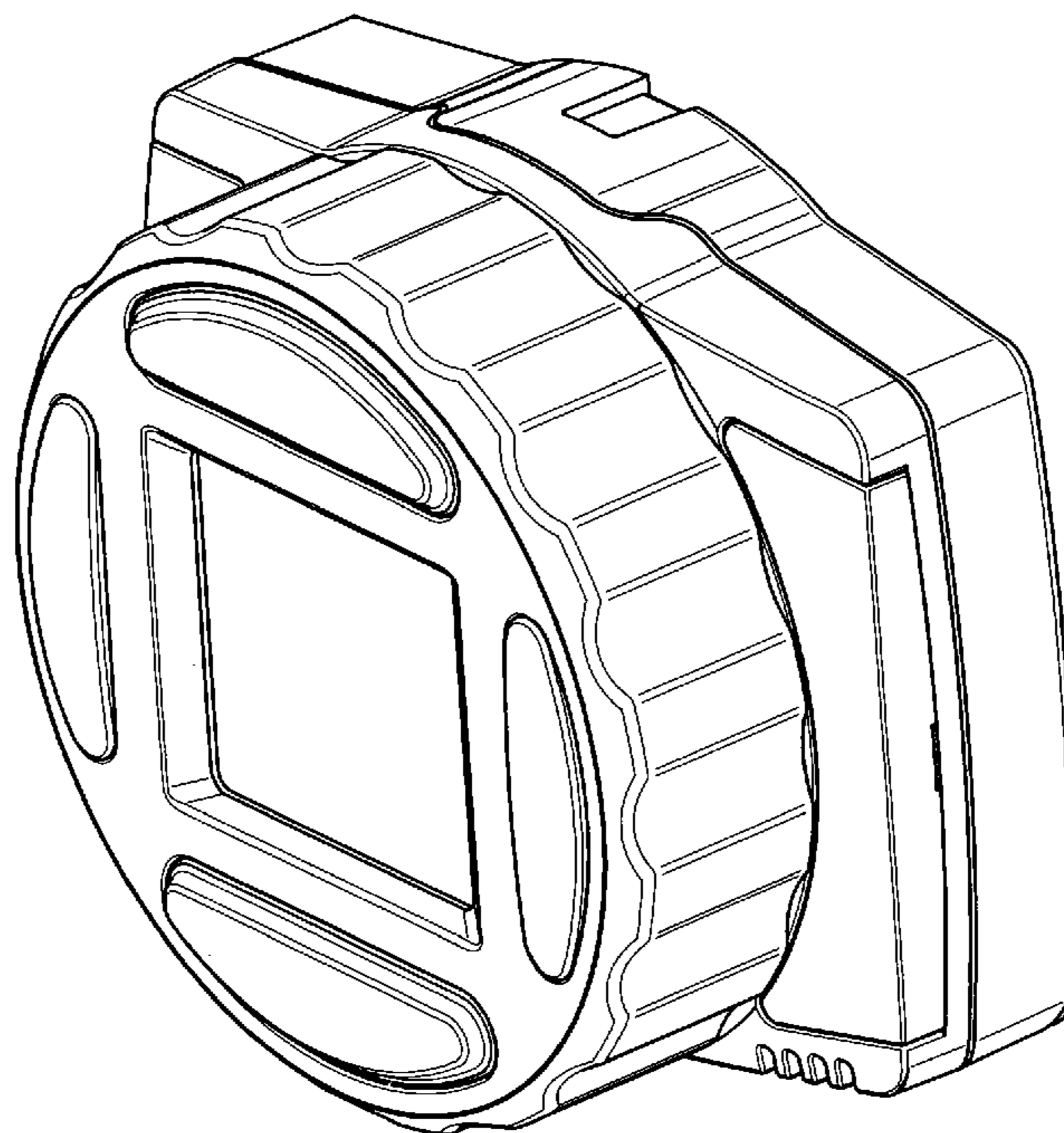

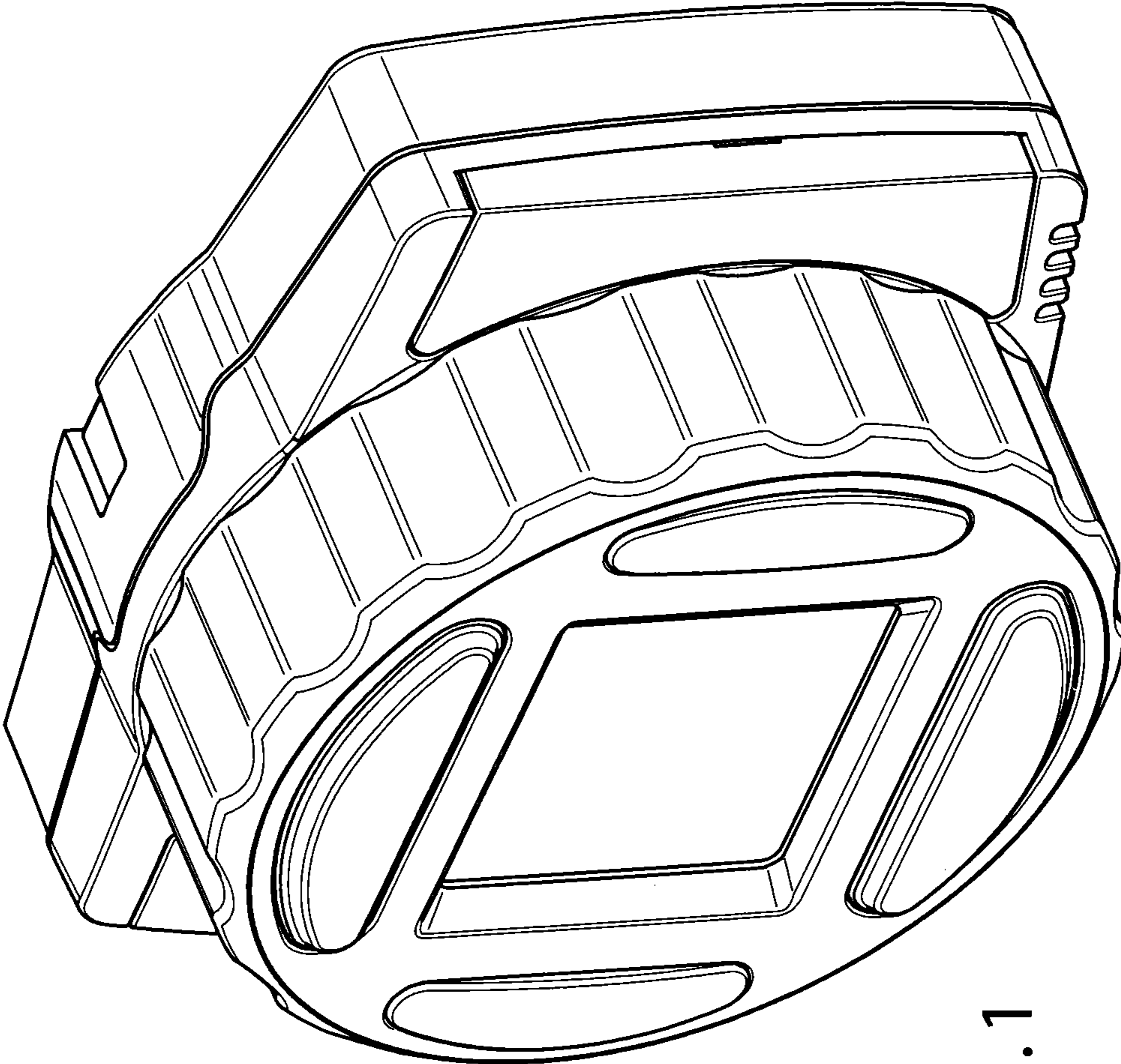

FIG. 1

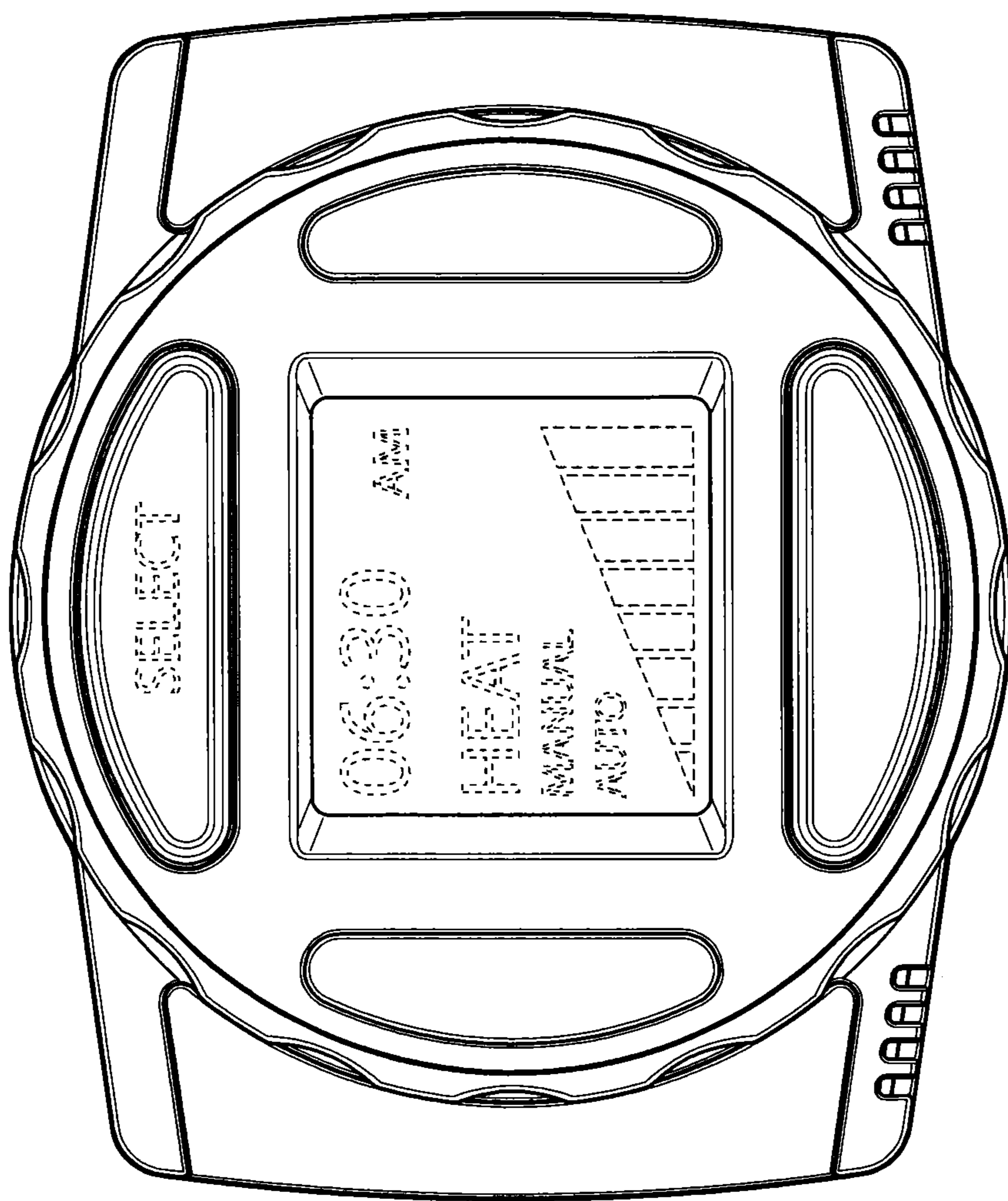

FIG. 2

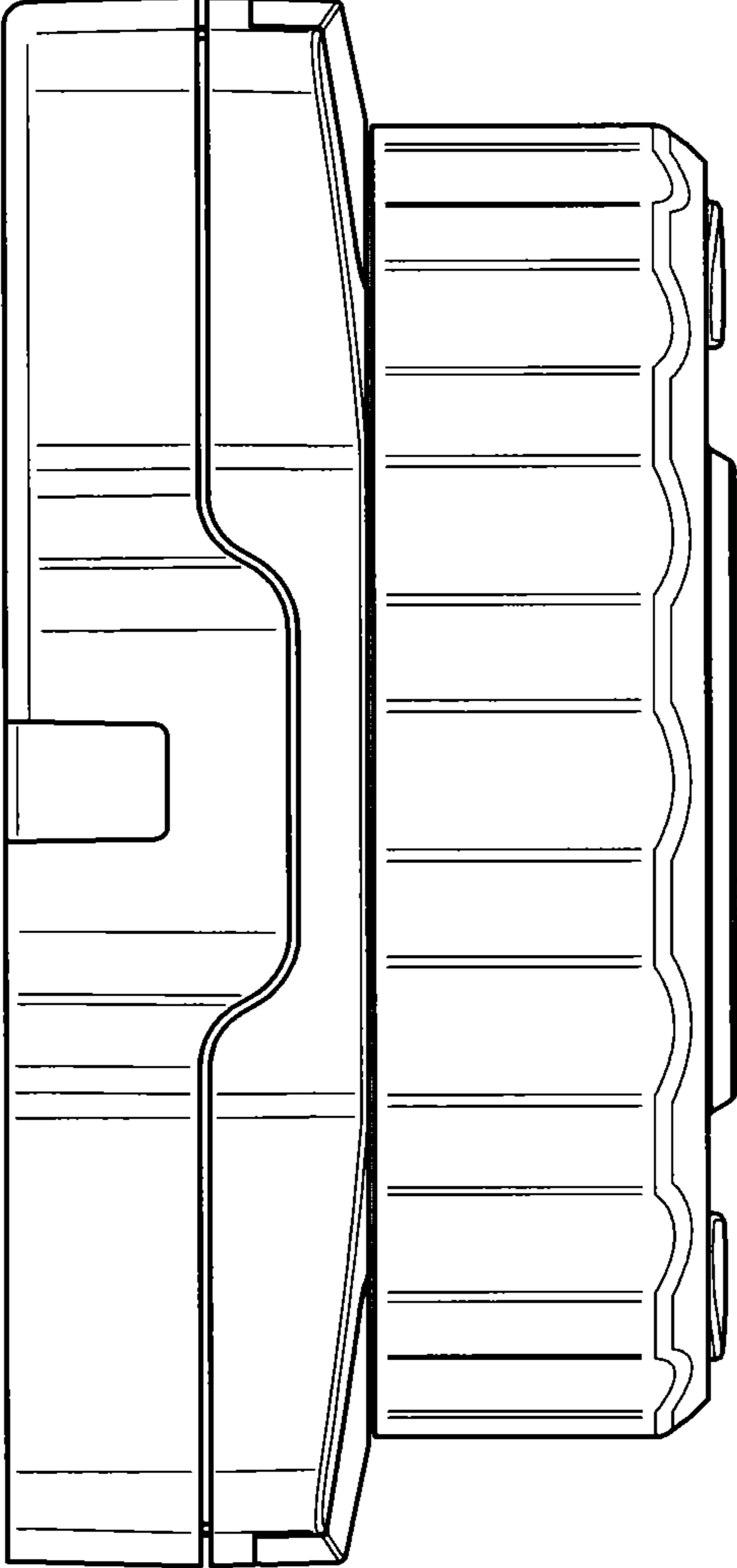

FIG. 3

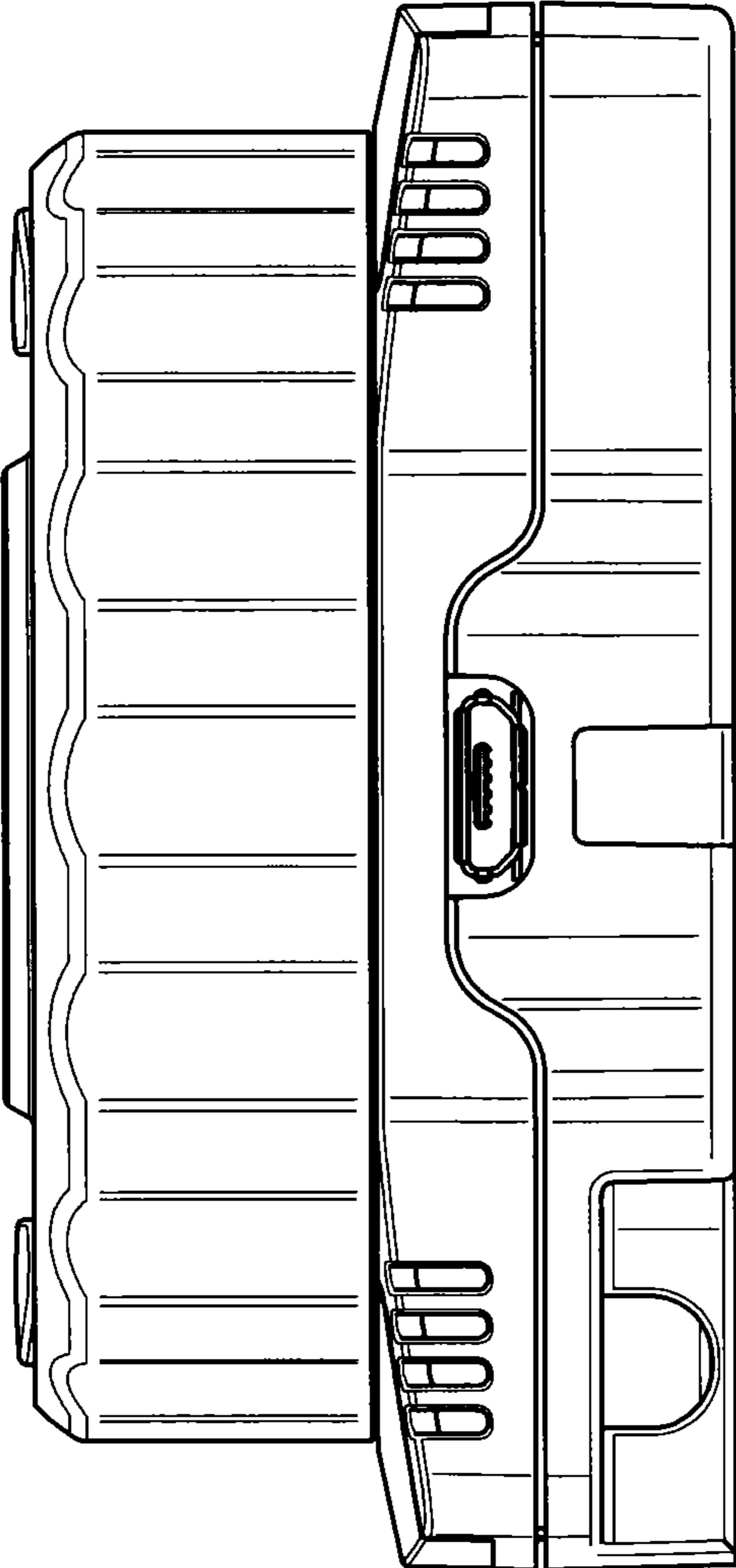

FIG. 4

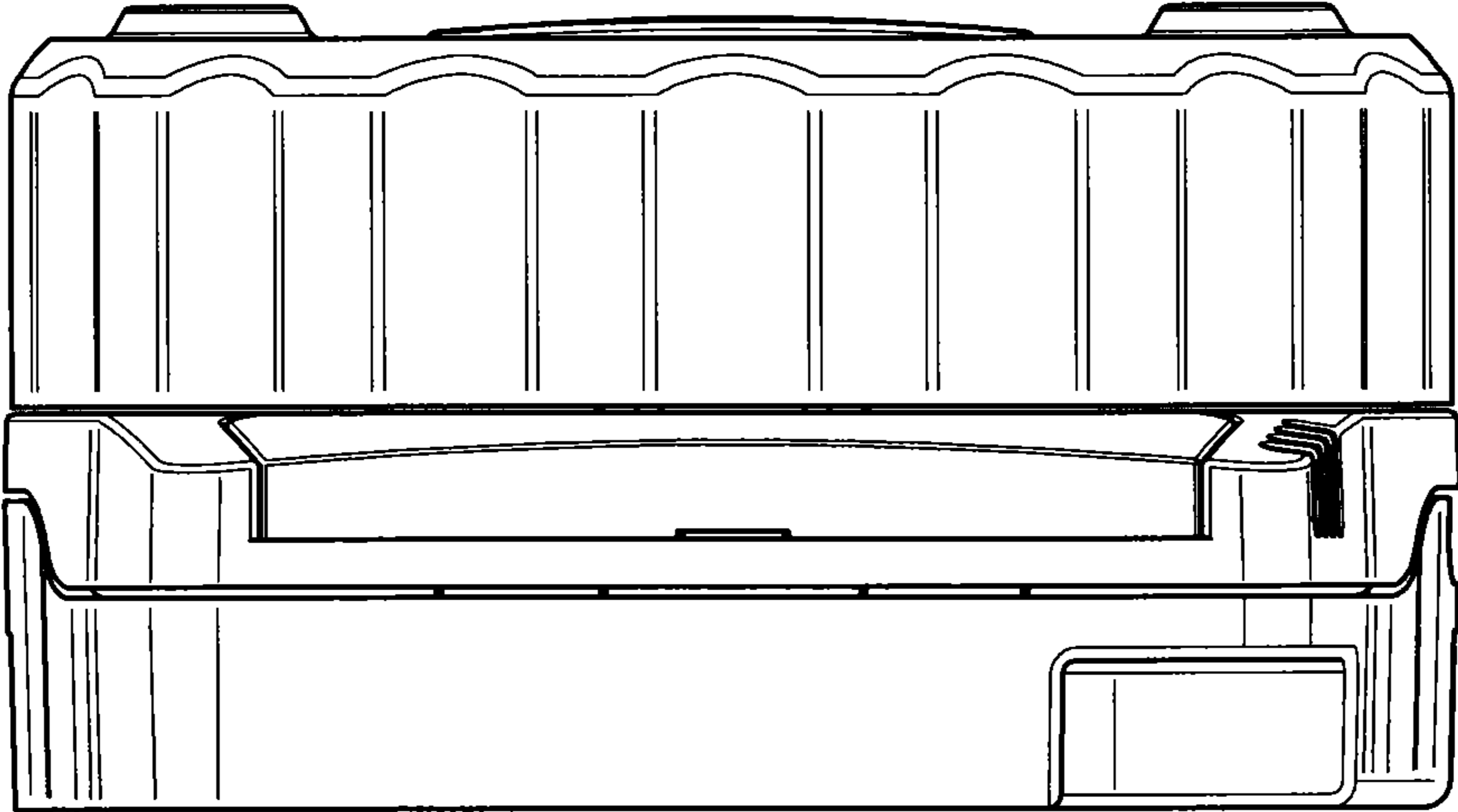

FIG. 5

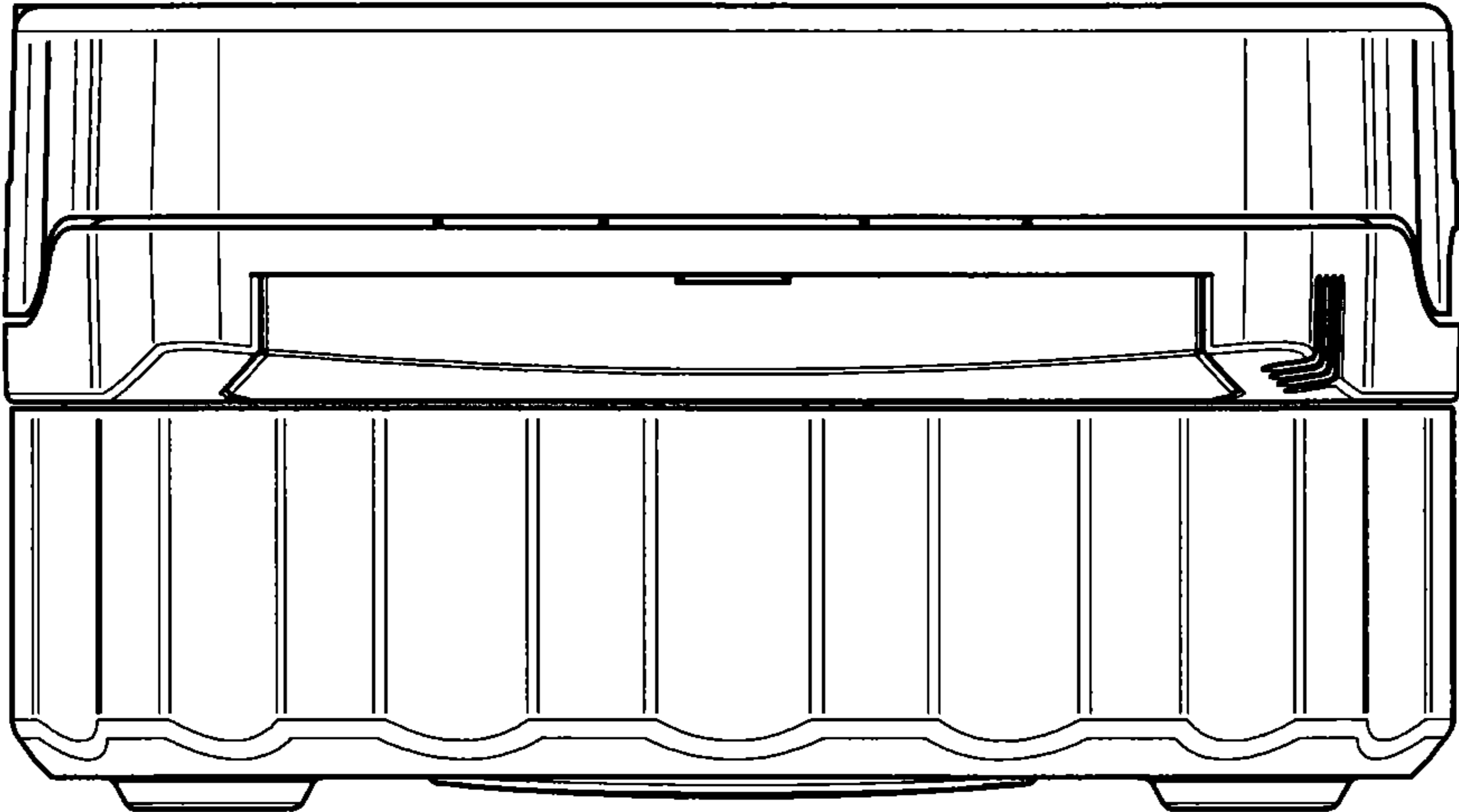

FIG. 6

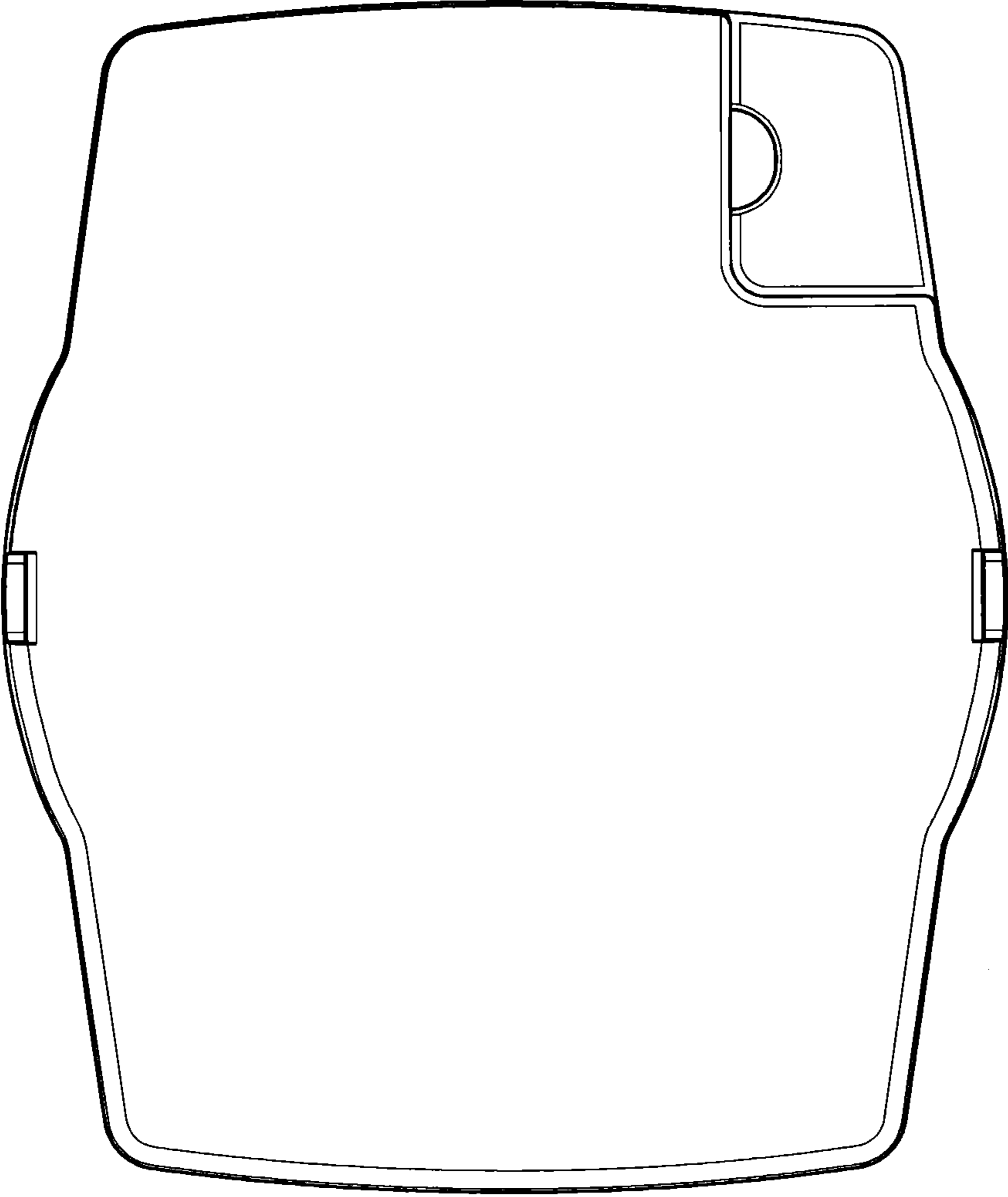

FIG. 7