

US00D731024S

(12) **United States Design Patent**
Elliott et al.

(10) **Patent No.:** **US D731,024 S**
(45) **Date of Patent:** **** Jun. 2, 2015**

(54) **PORTABLE BACTERIA DEACTIVATION DEVICE**

6,279,751 B1 * 8/2001 Malkin 210/457
D448,448 S * 9/2001 Hughes et al. D23/209
6,840,386 B2 * 1/2005 Steger et al. 210/457

(71) Applicant: **Silver Aqua, Inc.**, Carlisle, MA (US)

(Continued)

(72) Inventors: **David J. Elliott**, Carlisle, MA (US);
Ronald P. Millman, Jr., Taunton, MA (US);
Amber P. Truhanovitch, Webster, MA (US)

FOREIGN PATENT DOCUMENTS

EP 0 421 452 6/1996
EP 1134012 9/2001

(Continued)

(73) Assignee: **Silver Aqua, Inc.**, Carlisle, MA (US)

OTHER PUBLICATIONS

(**) Term: **14 Years**

Botl filter Portable Water Filter System User Guide flyer, www.botfilter.com, 2 pages.

(21) Appl. No.: **29/475,554**

(Continued)

(22) Filed: **Dec. 4, 2013**

Related U.S. Application Data

(63) Continuation of application No. 29/436,720, filed on Nov. 8, 2012, now abandoned.

(51) **LOC (10) Cl.** **23-01**

(52) **U.S. Cl.**
USPC **D23/207**

(58) **Field of Classification Search**
USPC D23/207-209; 210/232, 282, 497.01, 210/498

See application file for complete search history.

(56) **References Cited**

U.S. PATENT DOCUMENTS

3,563,388 A * 2/1971 Briggs 210/457
4,267,455 A 5/1981 Keller
4,349,512 A 9/1982 Berger
4,695,379 A 9/1987 Nohren, Jr. et al.
4,894,154 A 1/1990 Roz et al.
5,045,195 A 9/1991 Spangrud et al.
H1157 H * 4/1993 Yanou et al. D23/209
5,496,468 A * 3/1996 Cormier 210/172.3
5,681,463 A 10/1997 Shimizu et al.

Primary Examiner — Robin V Webster

(74) *Attorney, Agent, or Firm* — Cesari and McKenna, LLP

(57) **CLAIM**

The ornamental design for a portable bacteria deactivation device, as shown and described.

DESCRIPTION

FIG. 1 is an isometric view from the front of a portable bacteria deactivation device incorporating the design;
FIG. 2 is a left-side view thereof;
FIG. 3 is a right-side view thereof;
FIG. 4 is a front view thereof;
FIG. 5 is a back view thereof;
FIG. 6 is a top plan view thereof;
FIG. 7 is a bottom plan view thereof;
FIG. 8 is an isometric view of an alternative embodiment;
FIG. 9 is a top view of the alternative embodiment;
FIG. 10 is a bottom view of the alternative embodiment;
FIG. 11 shows the article worn on a neck chain; and,
FIG. 12 shows the article being used to deactivate bacteria in a water bottle.
Parts of the drawings shown in dotted lines form no part of the claimed invention.

1 Claim, 10 Drawing Sheets

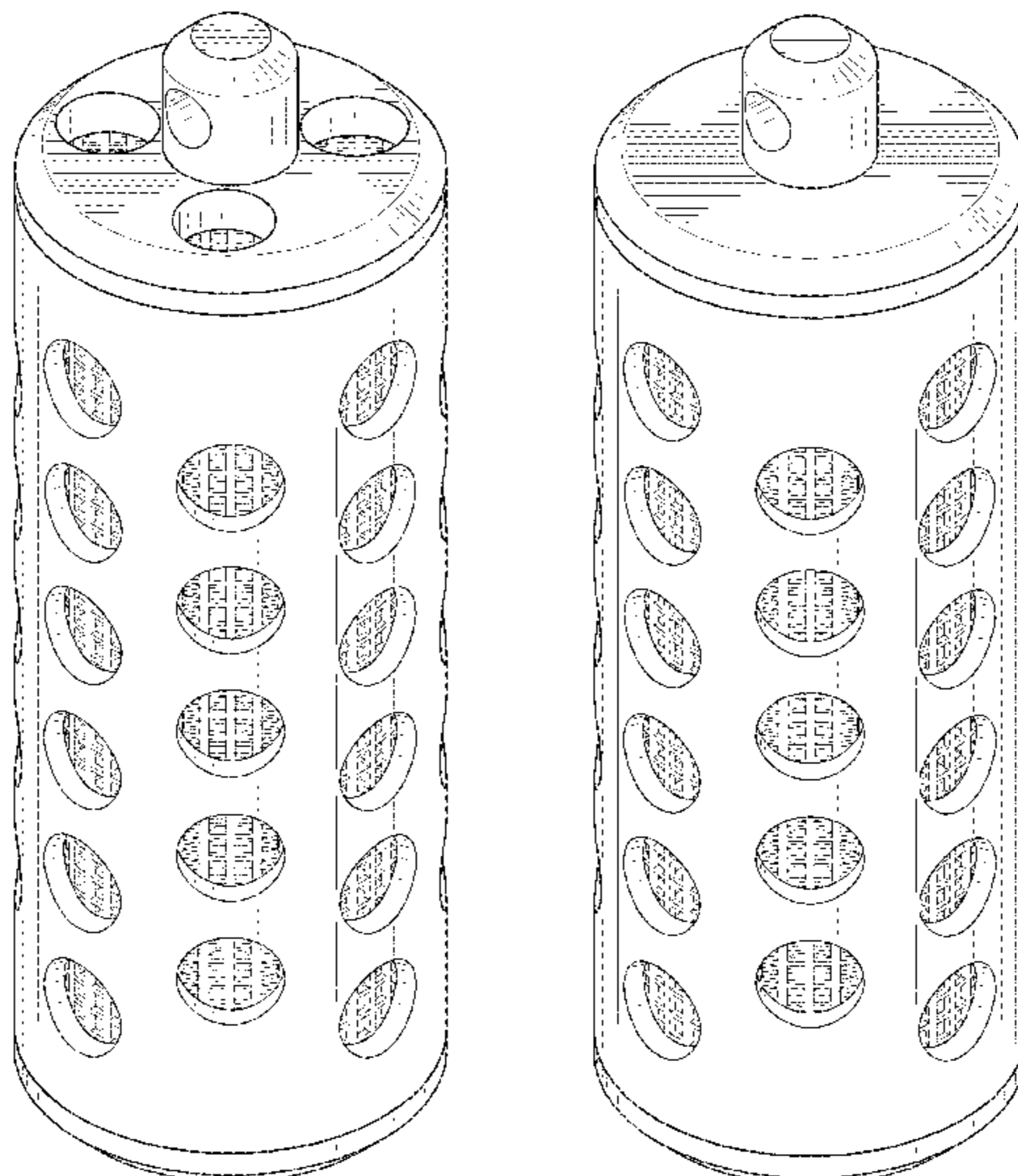

(56)

References Cited

U.S. PATENT DOCUMENTS

D506,526 S * 6/2005 Duncan et al. D23/209
 D551,318 S * 9/2007 MacNeil et al. D23/209
 7,441,665 B2 10/2008 Bridges et al.
 D642,658 S * 8/2011 Cumberland et al. D23/209
 D643,090 S * 8/2011 Cumberland et al. D23/209
 D643,508 S * 8/2011 Wilkinson et al. D23/209
 8,177,968 B2 5/2012 Wang
 8,394,268 B2 3/2013 O'Brien et al.
 2005/0106267 A1 5/2005 Frykman et al.
 2005/0242041 A1 11/2005 Cumberland
 2005/0263453 A1 12/2005 Collias et al.
 2006/0180550 A1 8/2006 Moore, III
 2008/0217252 A1 9/2008 Elliott et al.
 2010/0102002 A1 4/2010 O'Brien et al.
 2010/0276347 A1 11/2010 Cui
 2013/0032542 A1 2/2013 Golan

FOREIGN PATENT DOCUMENTS

WO 20081067816 6/2008
 WO 20091058707 5/2009
 WO 2012/031067 3/2012
 WO 20131046213 4/2013
 WO 2014/153349 9/2014

OTHER PUBLICATIONS

International Search Report and Written Opinion, mail date Feb. 6,
 2015 for International Application No. PCT/US2014/061991, Inter-
 national Filing Date Oct. 23, 2014 for Silver Aqua, Inc., 13 pages.

* cited by examiner

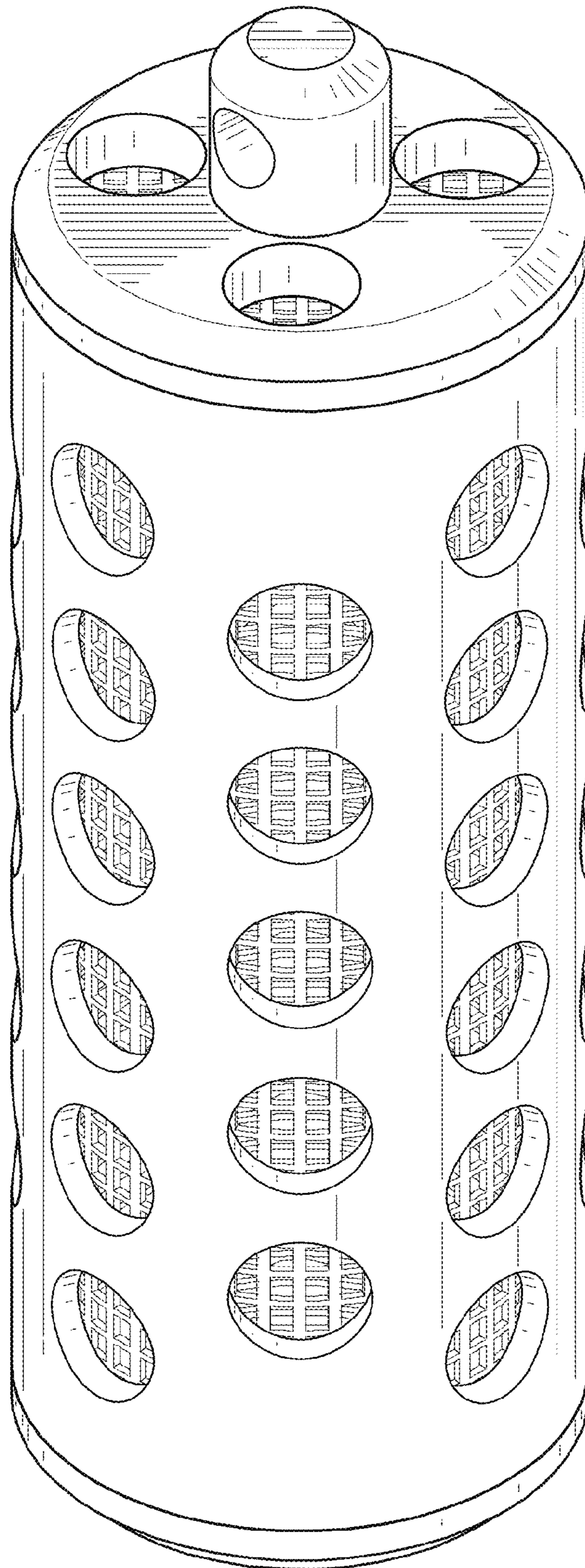

FIG. 1

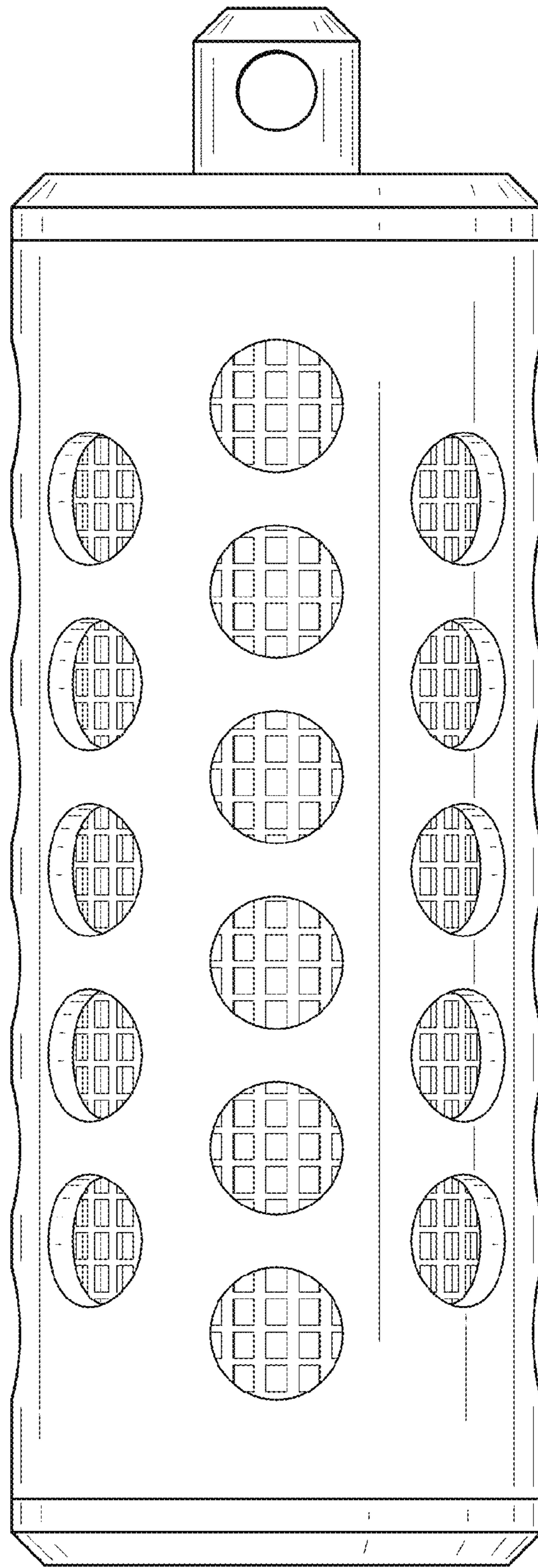

FIG. 2

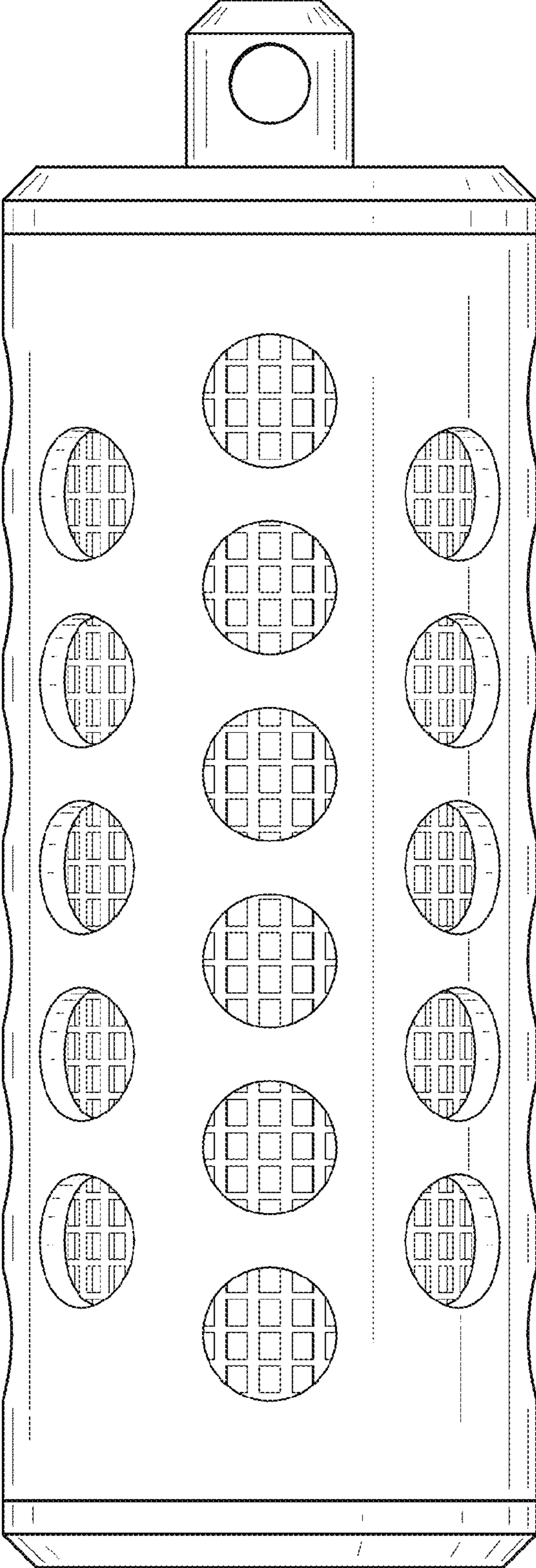

FIG. 3

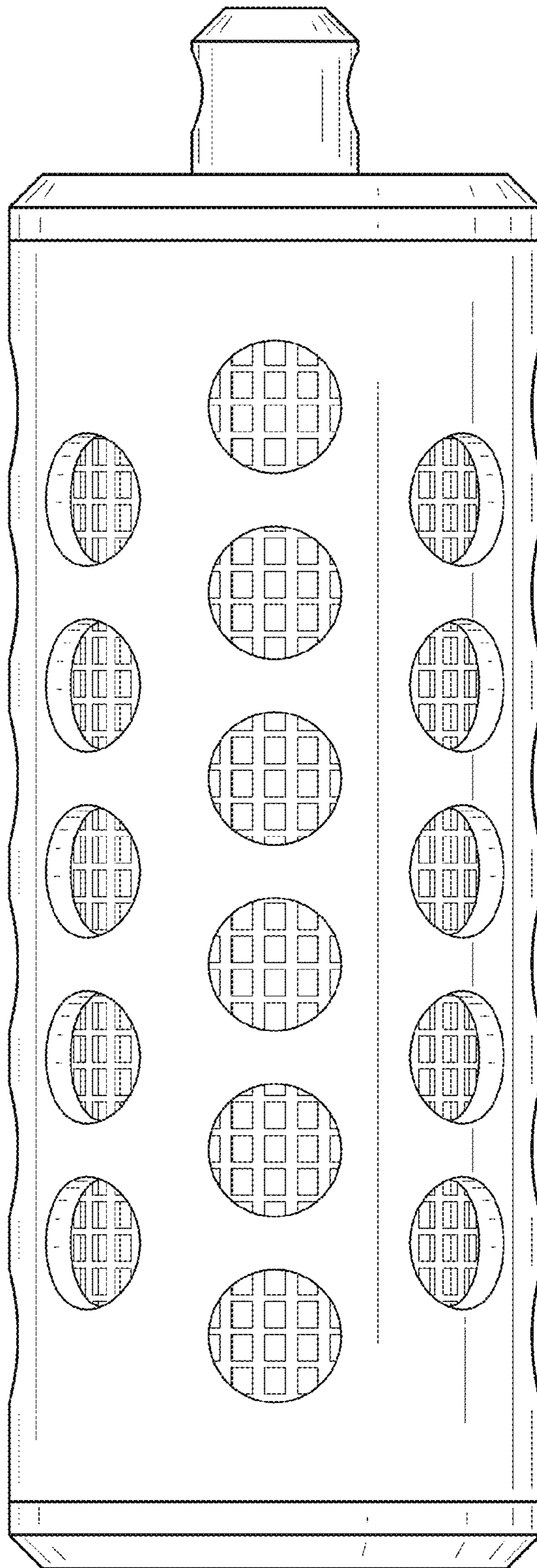

FIG. 4

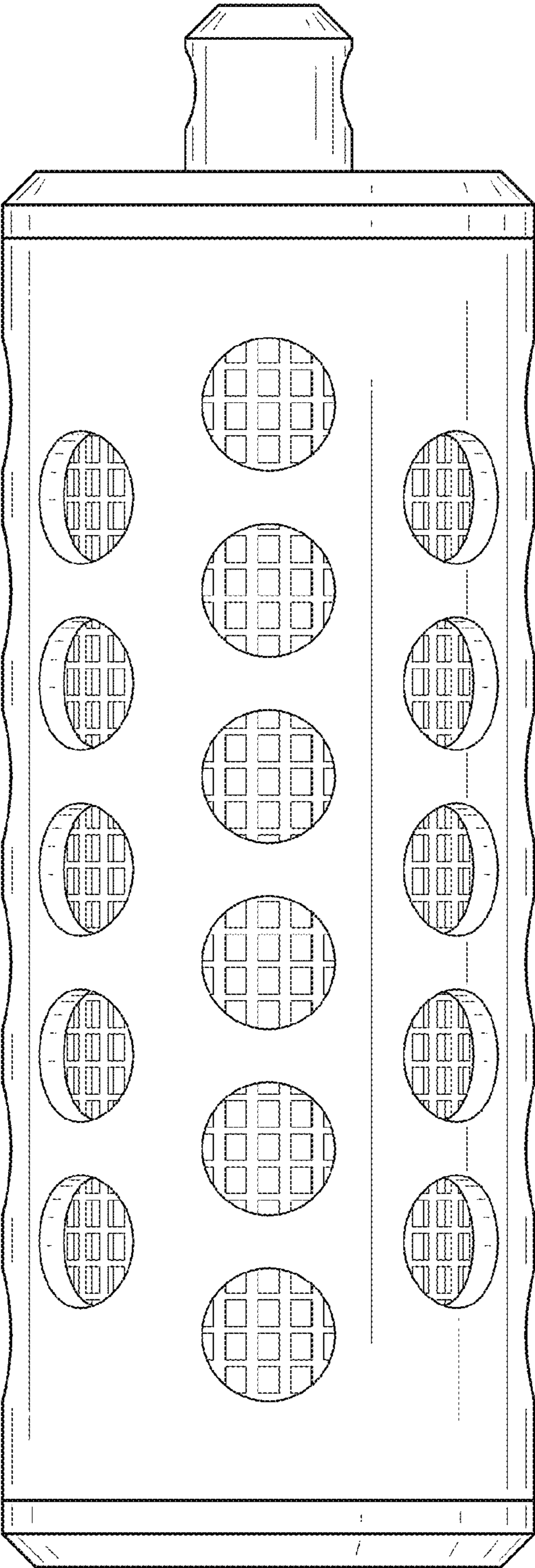

FIG. 5

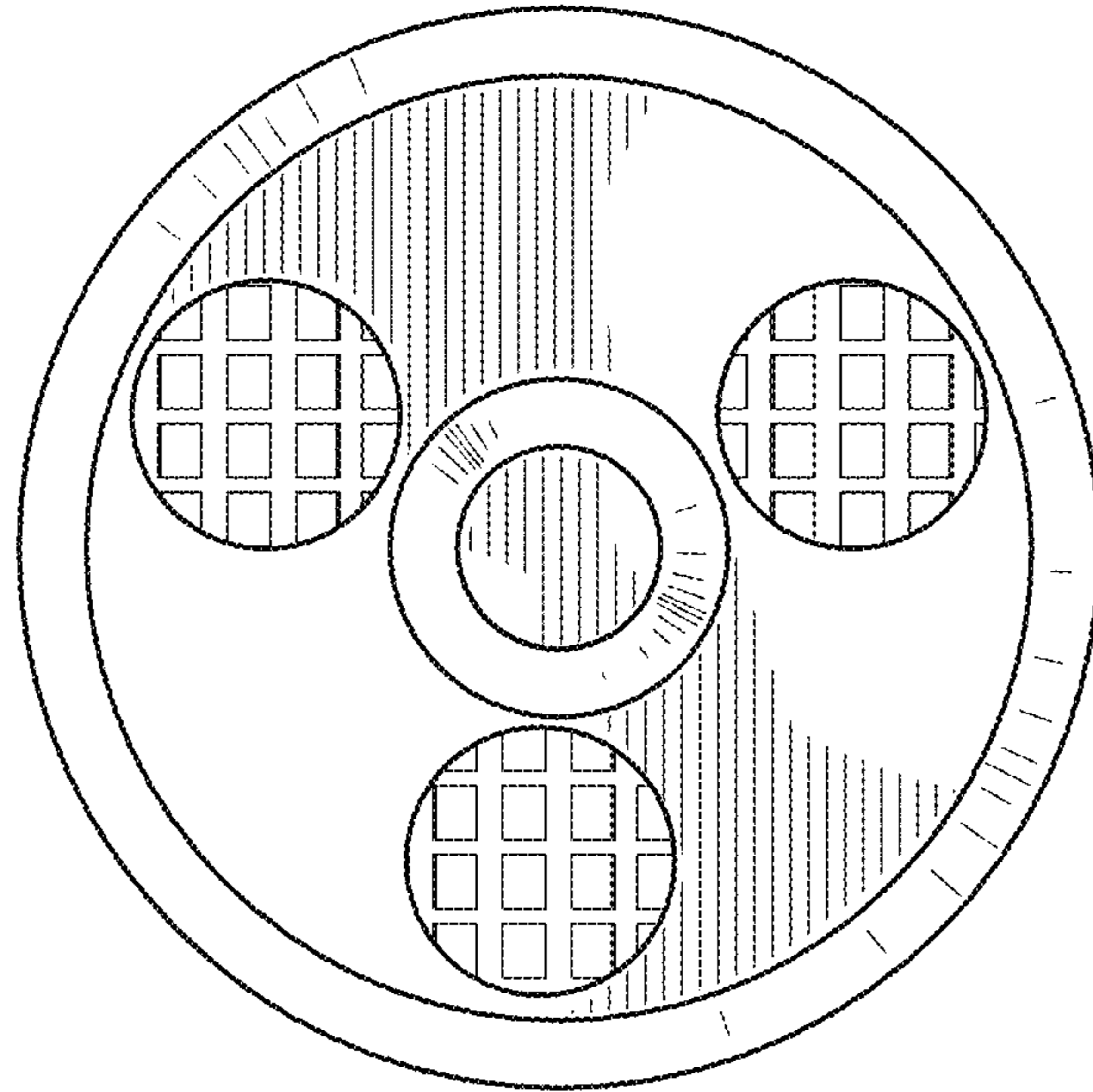

FIG. 6

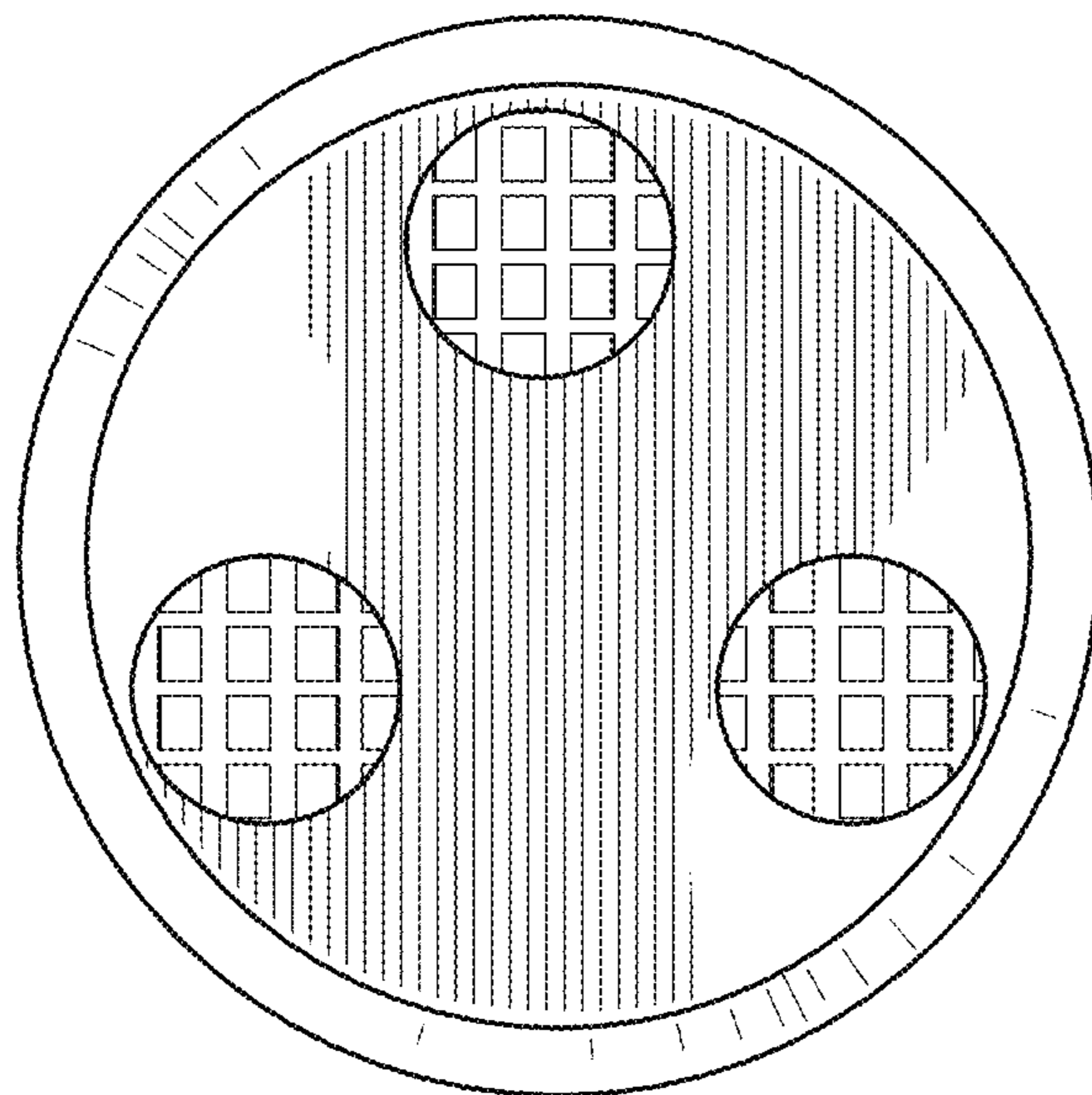

FIG. 7

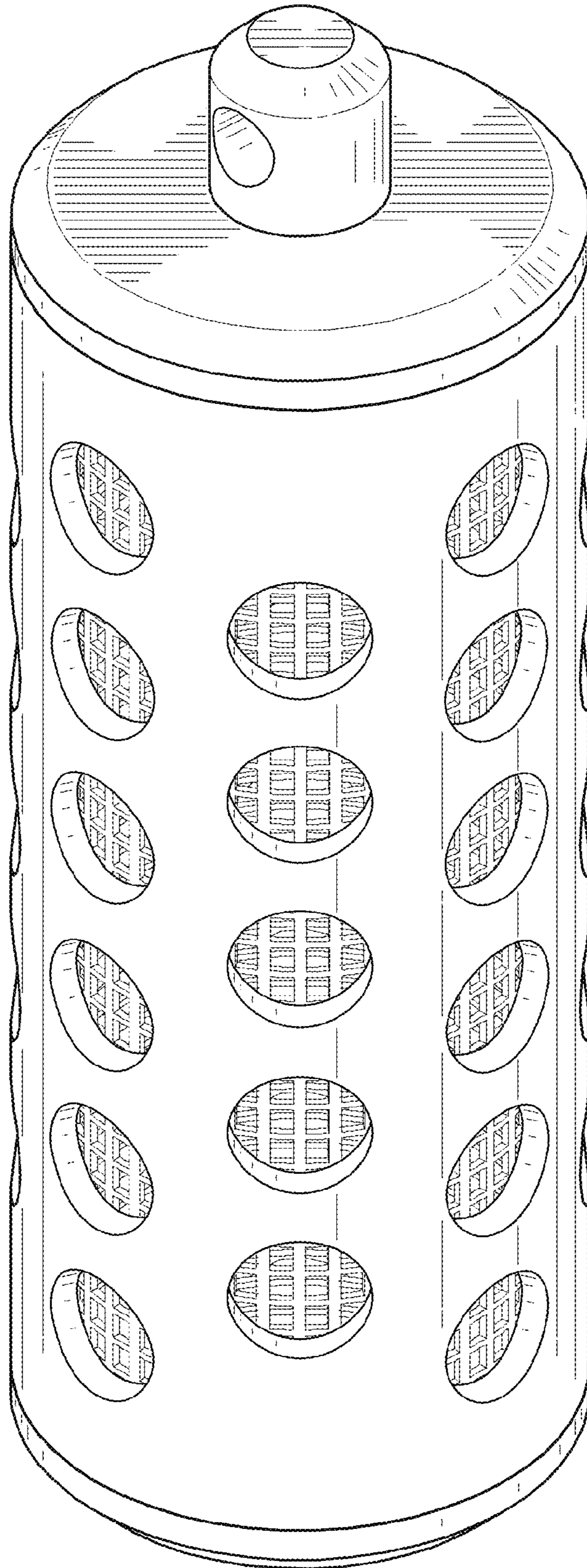

FIG. 8

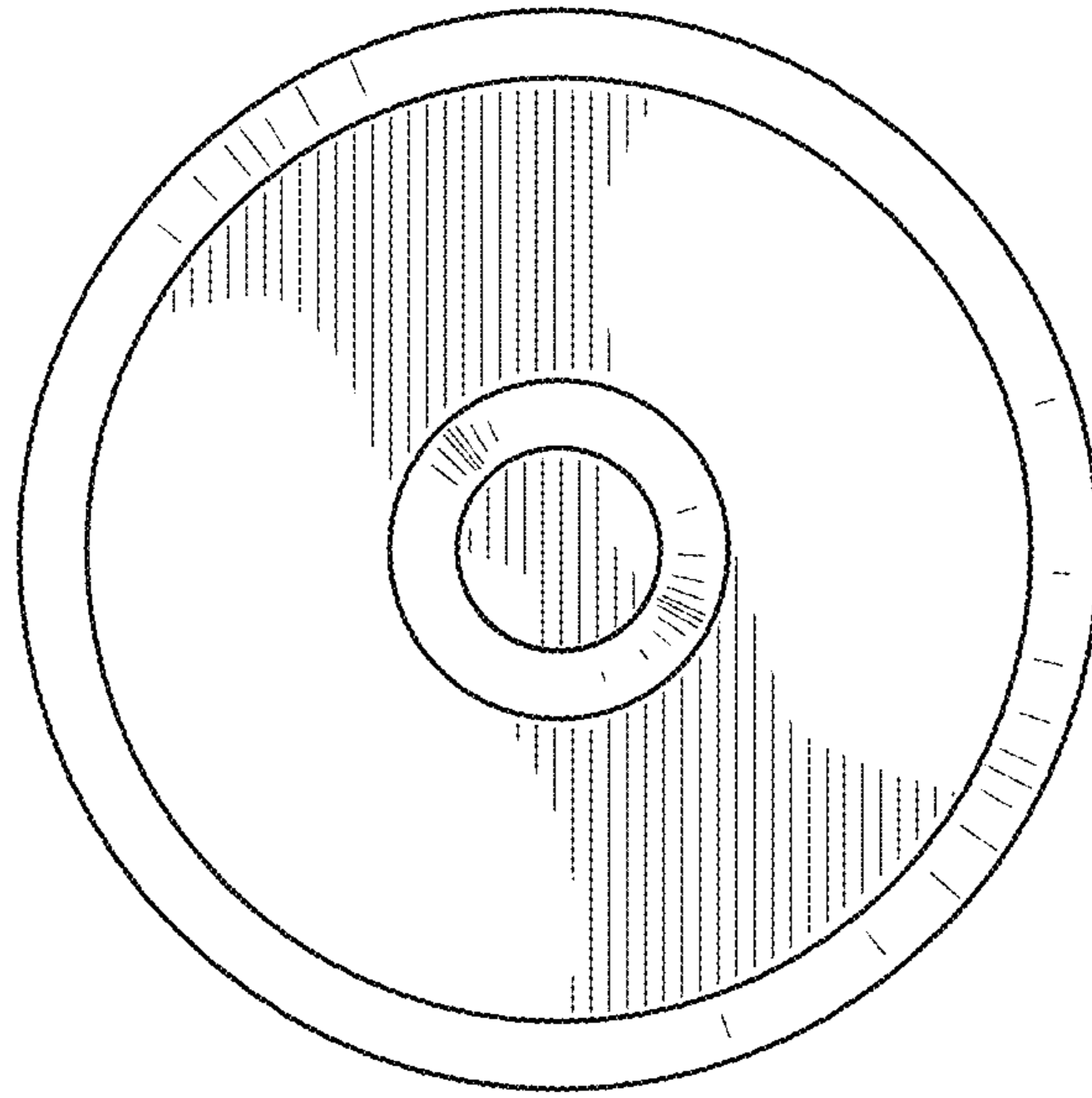

FIG. 9

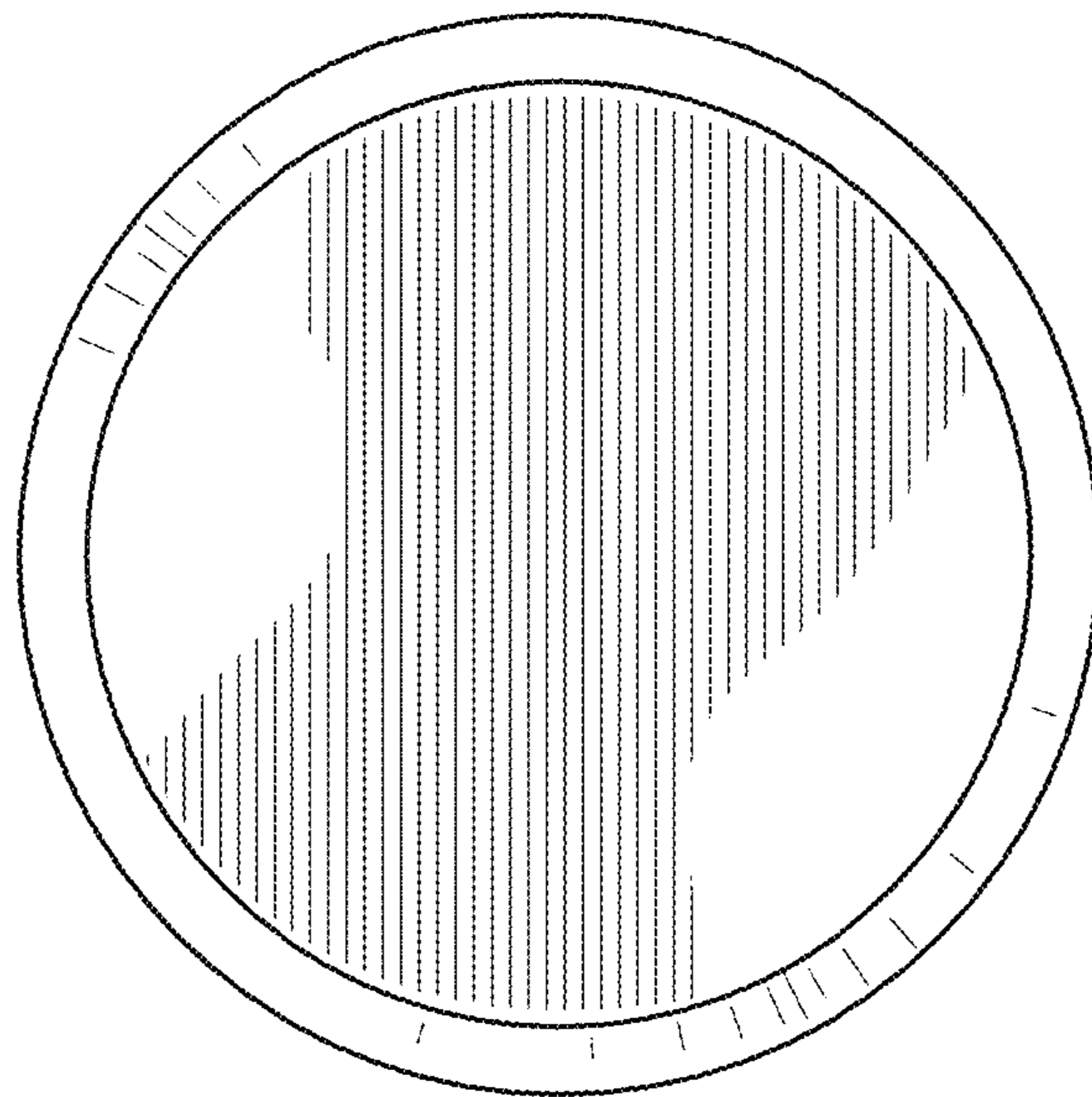

FIG. 10

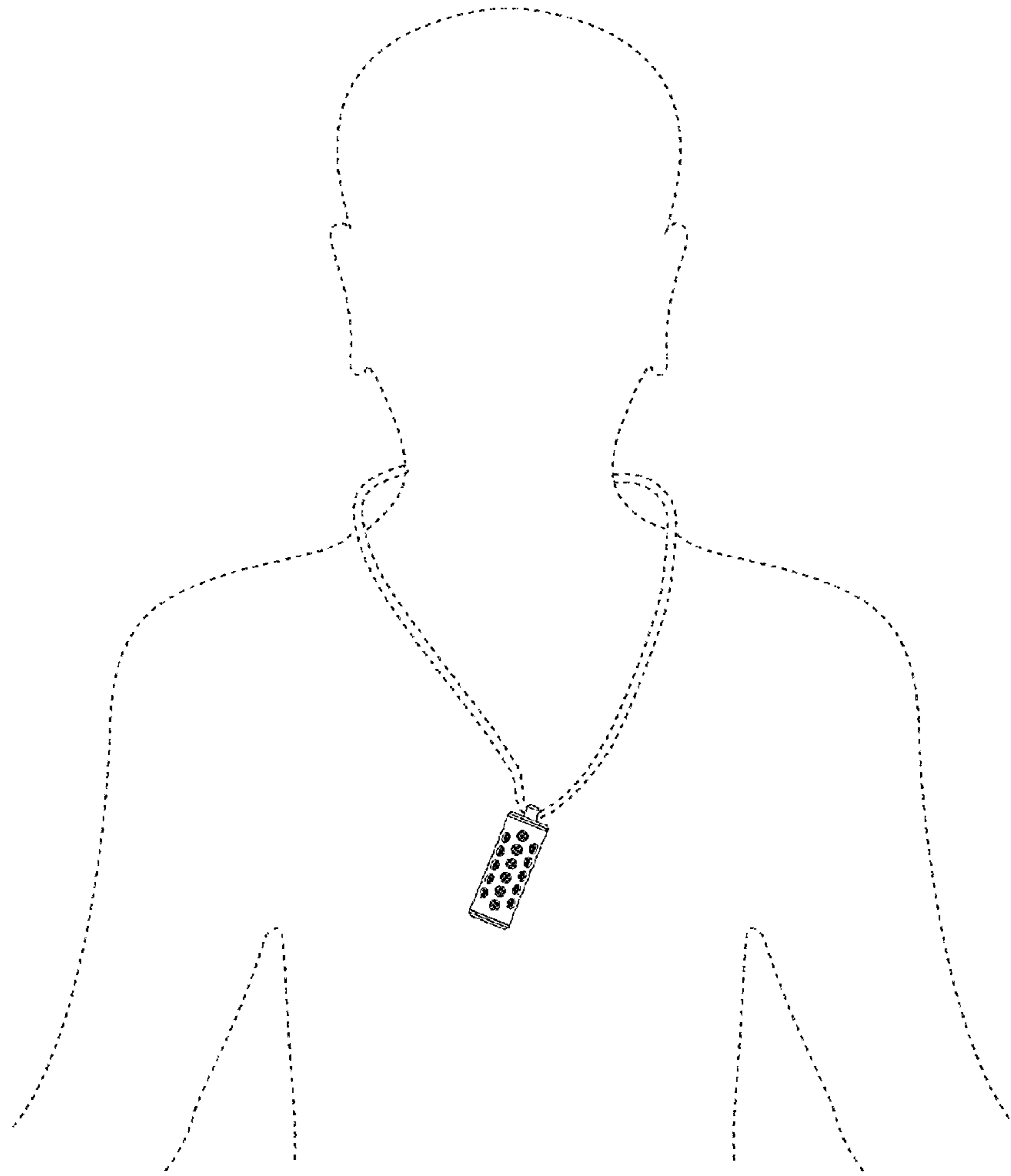

FIG. 11

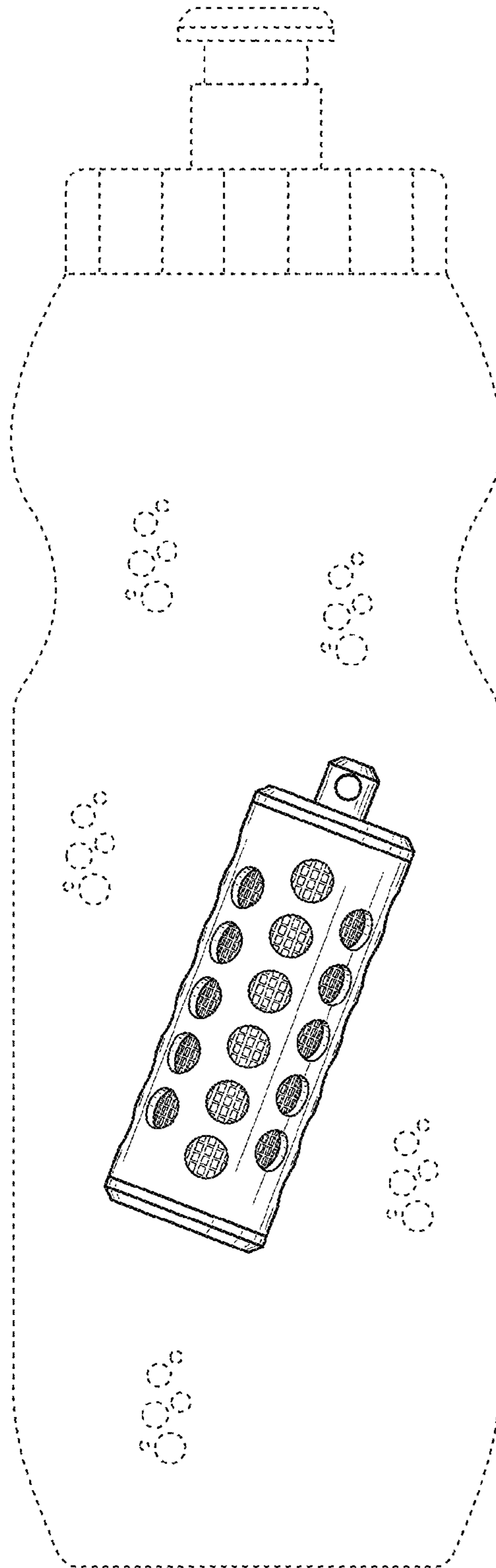

FIG. 12