



US00D731015S

(12) **United States Design Patent**  
**Murphy, Jr.**

(10) **Patent No.:** **US D731,015 S**  
(45) **Date of Patent:** **\*\* Jun. 2, 2015**

(54) **RACKET HANDLE**

(71) Applicant: **H. Stetser Murphy, Jr.**, Marietta, GA  
(US)

(72) Inventor: **H. Stetser Murphy, Jr.**, Marietta, GA  
(US)

(\*\*) Term: **14 Years**

(21) Appl. No.: **29/499,481**

(22) Filed: **Aug. 15, 2014**

(51) **LOC (10) Cl.** ..... **21-02**

(52) **U.S. Cl.**  
USPC ..... **D21/756**

(58) **Field of Classification Search**  
USPC ..... D21/729-732, 756-758  
CPC ..... A63B 49/00-49/14; A63B  
2049/0205-2049/103

See application file for complete search history.

(56) **References Cited**

U.S. PATENT DOCUMENTS

1,638,454 A	8/1927	Papin	
2,166,044 A	7/1939	Lewthwaite	
D125,473 S *	2/1941	Karoff	D21/729
D196,268 S *	9/1963	Lamb	D21/756
D247,189 S	2/1978	Charpentier	
4,174,109 A	11/1979	Gaiser	
4,438,925 A *	3/1984	Lindstrom	473/551
4,736,950 A *	4/1988	Doyle	473/538
D307,930 S	5/1990	Sokol et al.	
5,294,117 A	3/1994	Huang	
D355,232 S *	2/1995	Hodges	D21/730
5,492,324 A *	2/1996	Hagey	473/551
D378,389 S	3/1997	Manu	
D380,244 S	6/1997	Naumoff	
5,671,926 A *	9/1997	Hagey	473/549
D394,094 S	5/1998	Davis et al.	
D477,645 S *	7/2003	Vito	D21/756
D484,206 S *	12/2003	Udwin et al.	D21/731
D484,556 S *	12/2003	Udwin et al.	D21/731
D488,844 S *	4/2004	Szelenyi	D21/729
8,298,101 B2 *	10/2012	Babolat	473/551
D703,779 S	4/2014	Budacesek	
D716,885 S *	11/2014	Murphy, Jr.	D21/756

\* cited by examiner

Primary Examiner — Mitchell Siegel

(74) *Attorney, Agent, or Firm* — McGurk Intellectual Property Advisors

(57) **CLAIM**

I claim the ornamental design for a racket handle, as shown and described.

**DESCRIPTION**

FIG. 1 is a perspective view of a design of a racket handle illustrating the claimed design, wherein the racket handle is attached to a tennis racket;

FIG. 2 is a front view of the design of the racket handle shown in FIG. 1;

FIG. 3 is a back view of the design of the racket handle shown in FIG. 1;

FIG. 4 is a left side view of the design of the racket handle shown in FIG. 1;

FIG. 5 is a right side view of the design of the racket handle shown in FIG. 1;

FIG. 6 is a top view of the design of the racket handle shown in FIG. 1;

FIG. 7 is a bottom view of the design of the racket handle shown in FIG. 1.

FIG. 8 is an enlarged perspective view of the design of the racket handle of FIG. 1 excluding the head and neck portions of the tennis racket shown in FIG. 1.

FIG. 9 is an enlarged front view of the design of the racket handle shown in FIG. 8.

FIG. 10 is an enlarged back view of the design of the racket handle shown in FIG. 8.

FIG. 11 is an enlarged left side view of the design of the racket handle shown in FIG. 8.

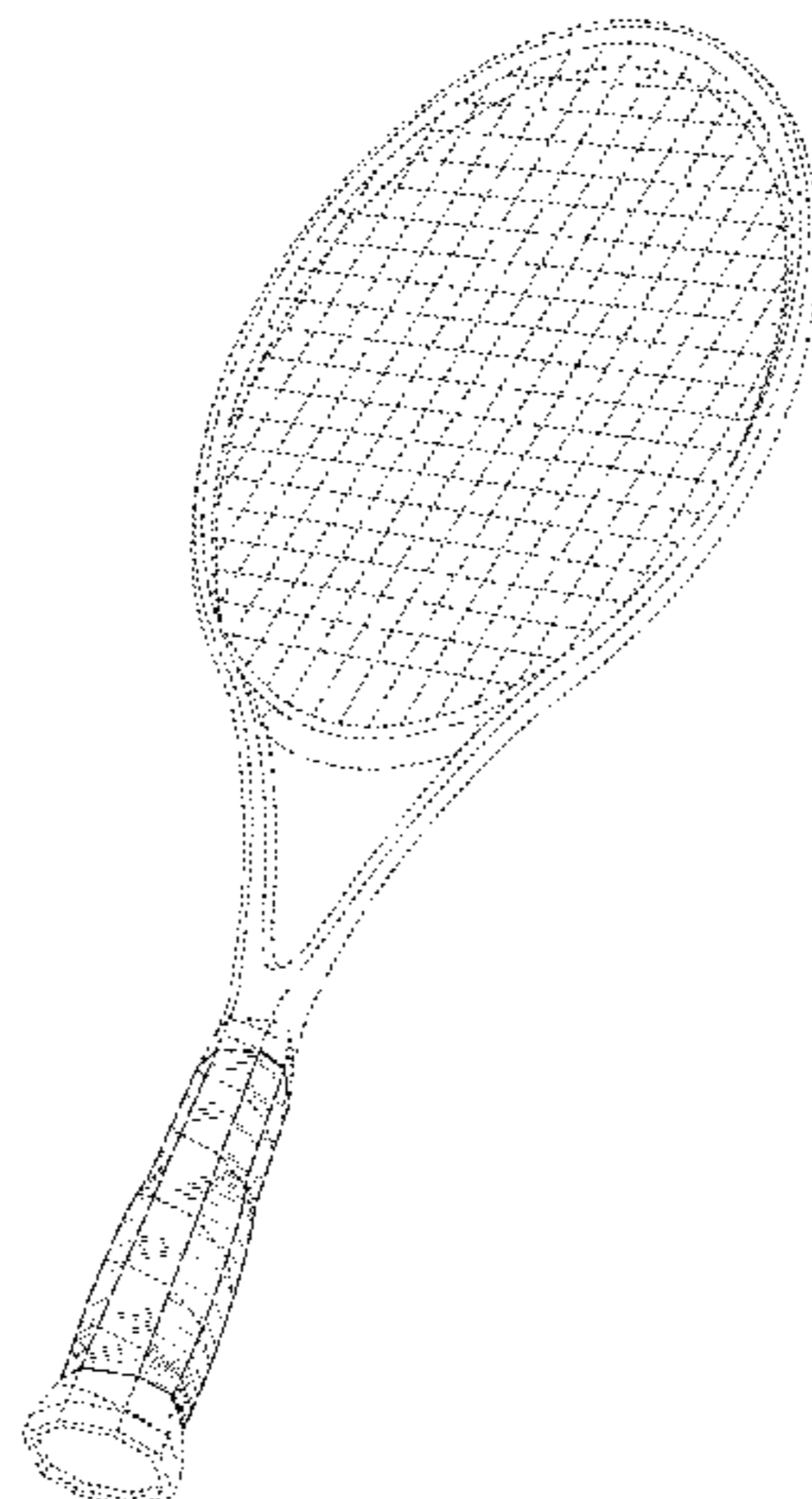
FIG. 12 is an enlarged right side view of the design of the racket handle shown in FIG. 8.

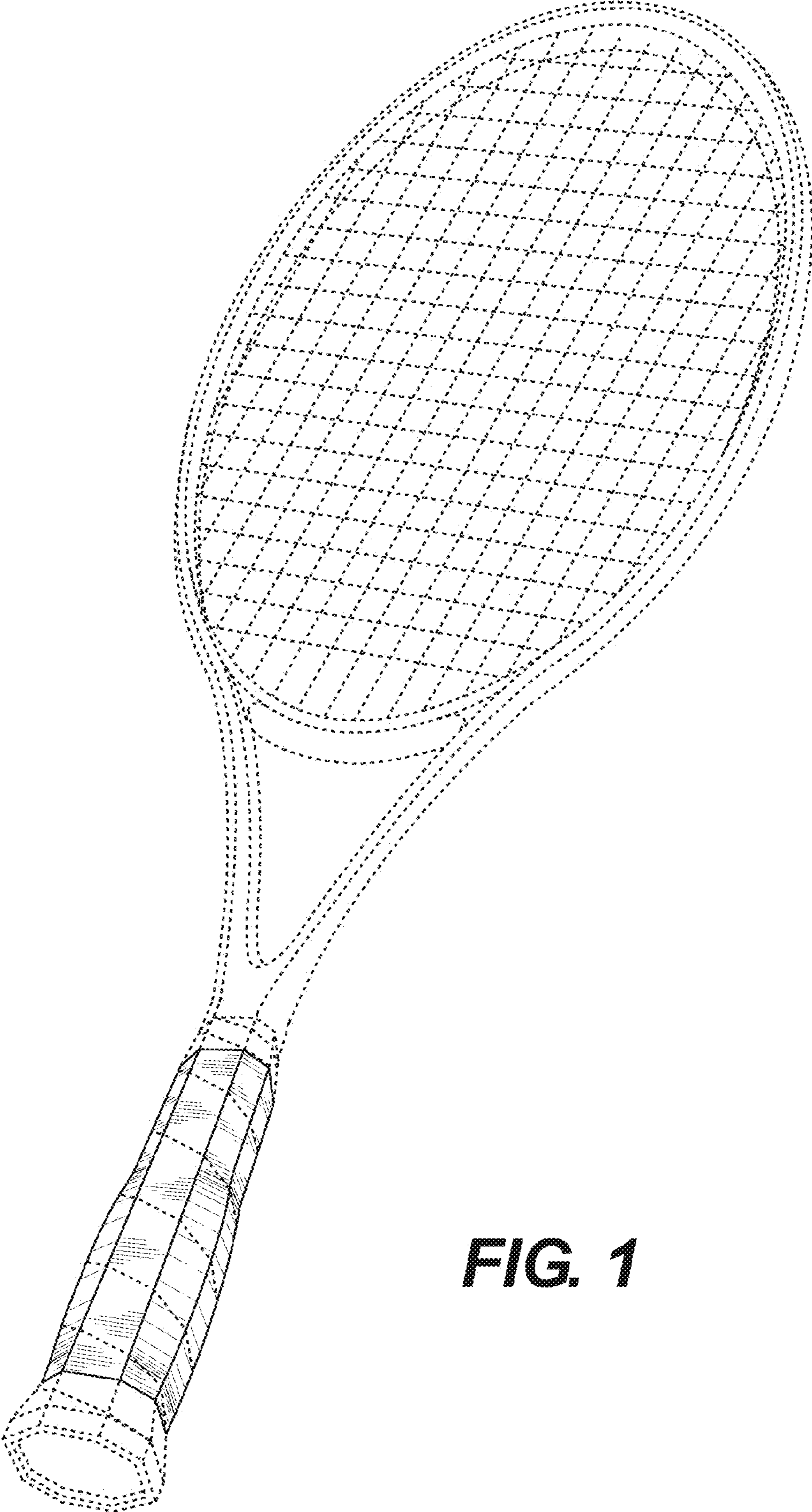
FIG. 13 is a cross-sectional view taken along line 13-13 of FIG. 9 of the design of the Racket handle shown in FIG. 8; and,

FIG. 14 is a bottom view of the design of the racket handle shown in FIG. 8.

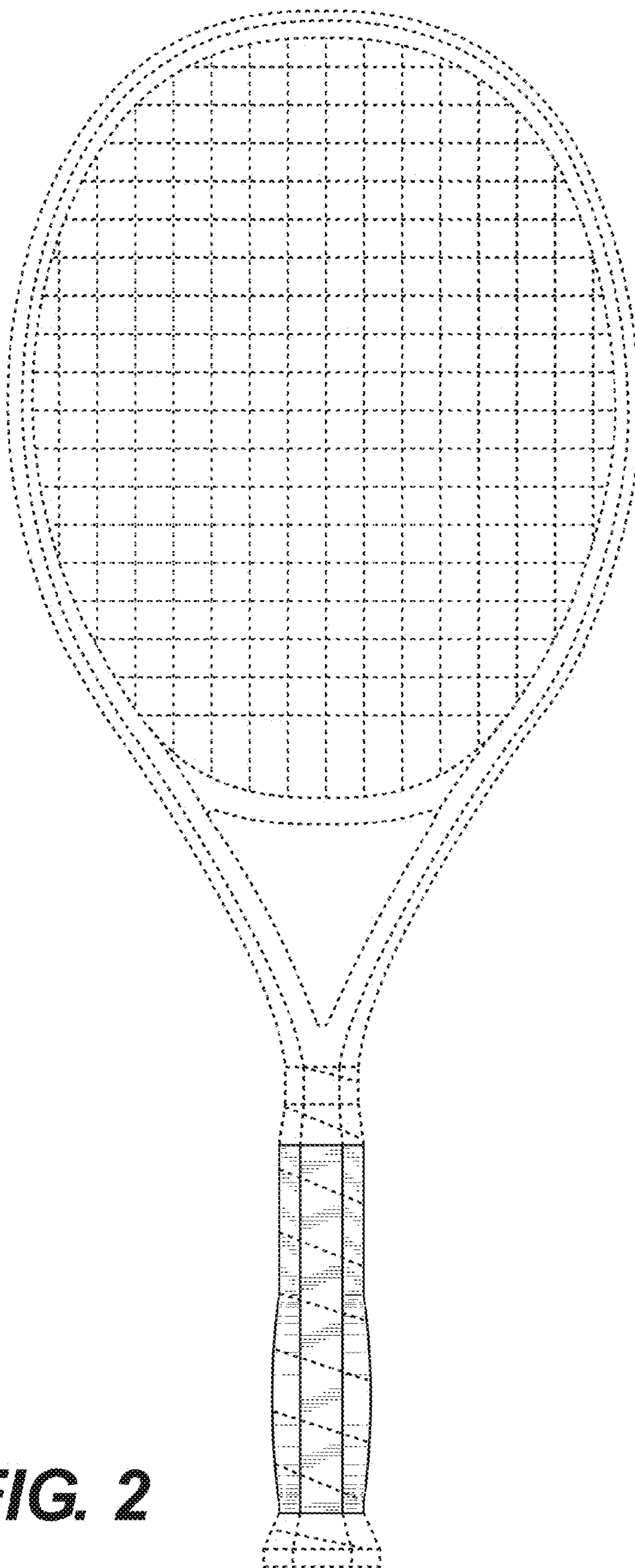
The broken lines in the drawings are for illustrative purposes only and form no part of the claimed design.

**1 Claim, 9 Drawing Sheets**

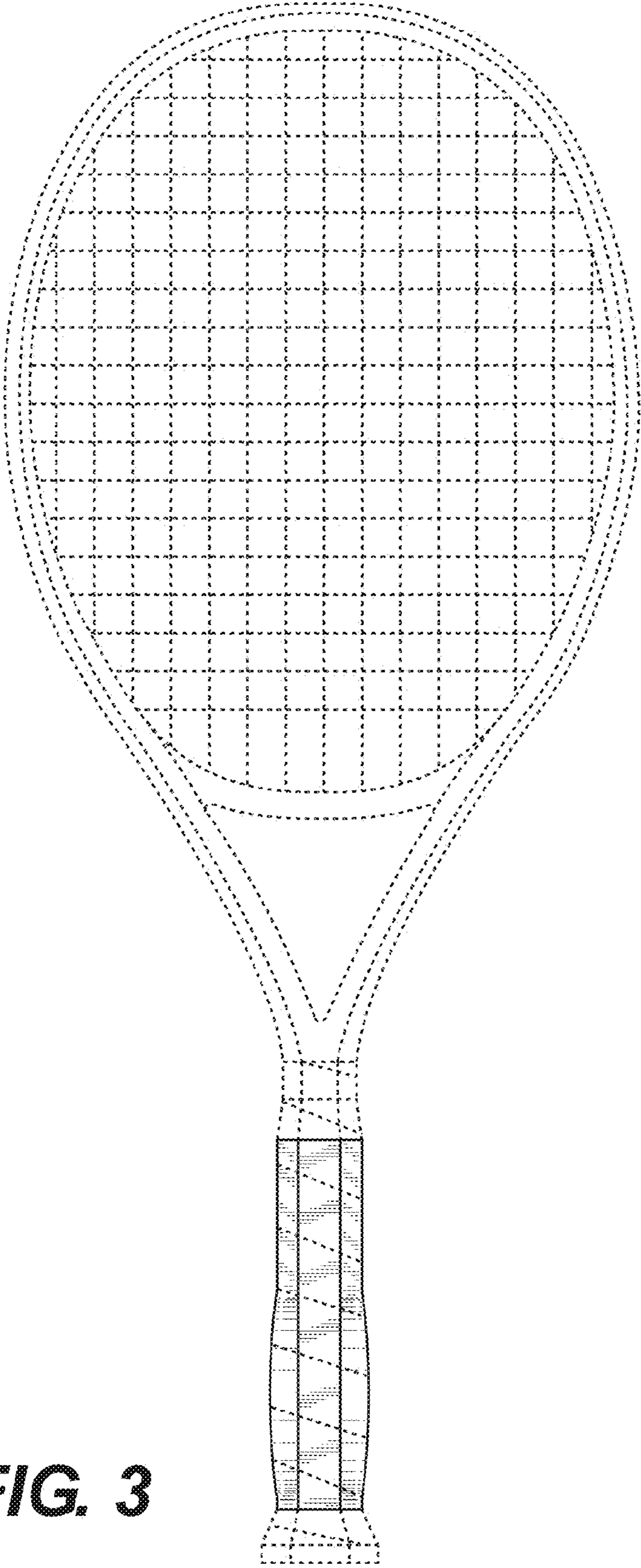




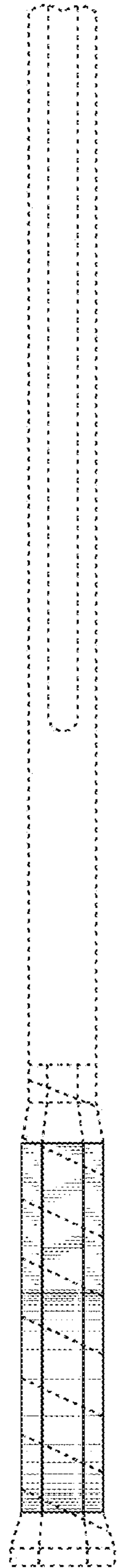
**FIG. 1**



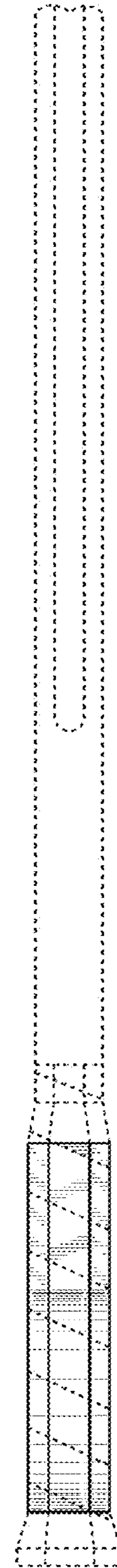
**FIG. 2**



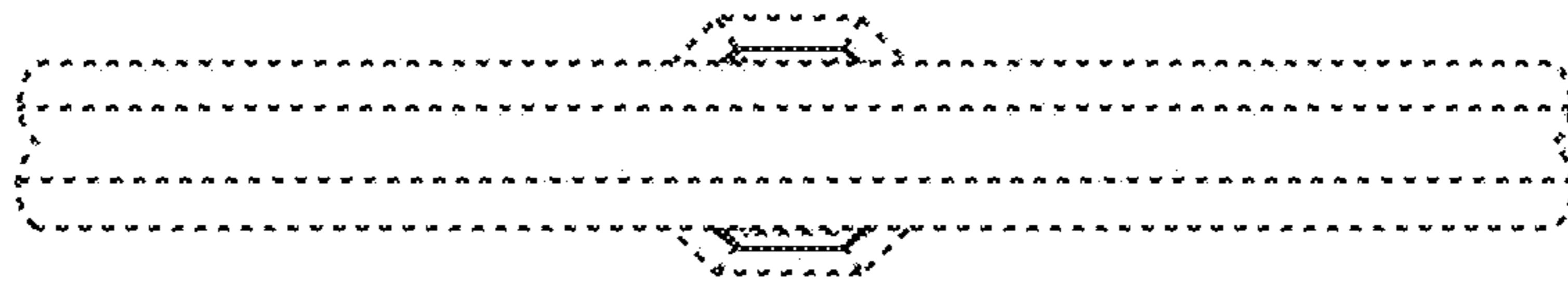
**FIG. 3**



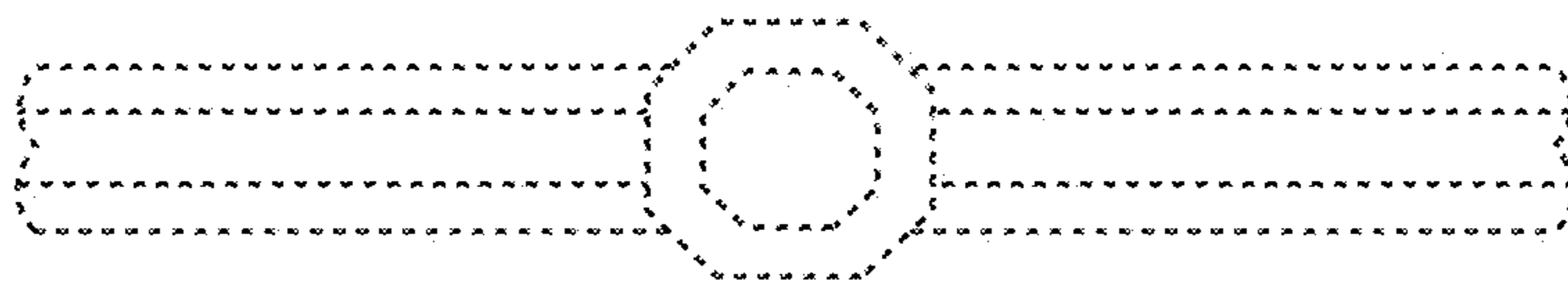
**FIG. 4**



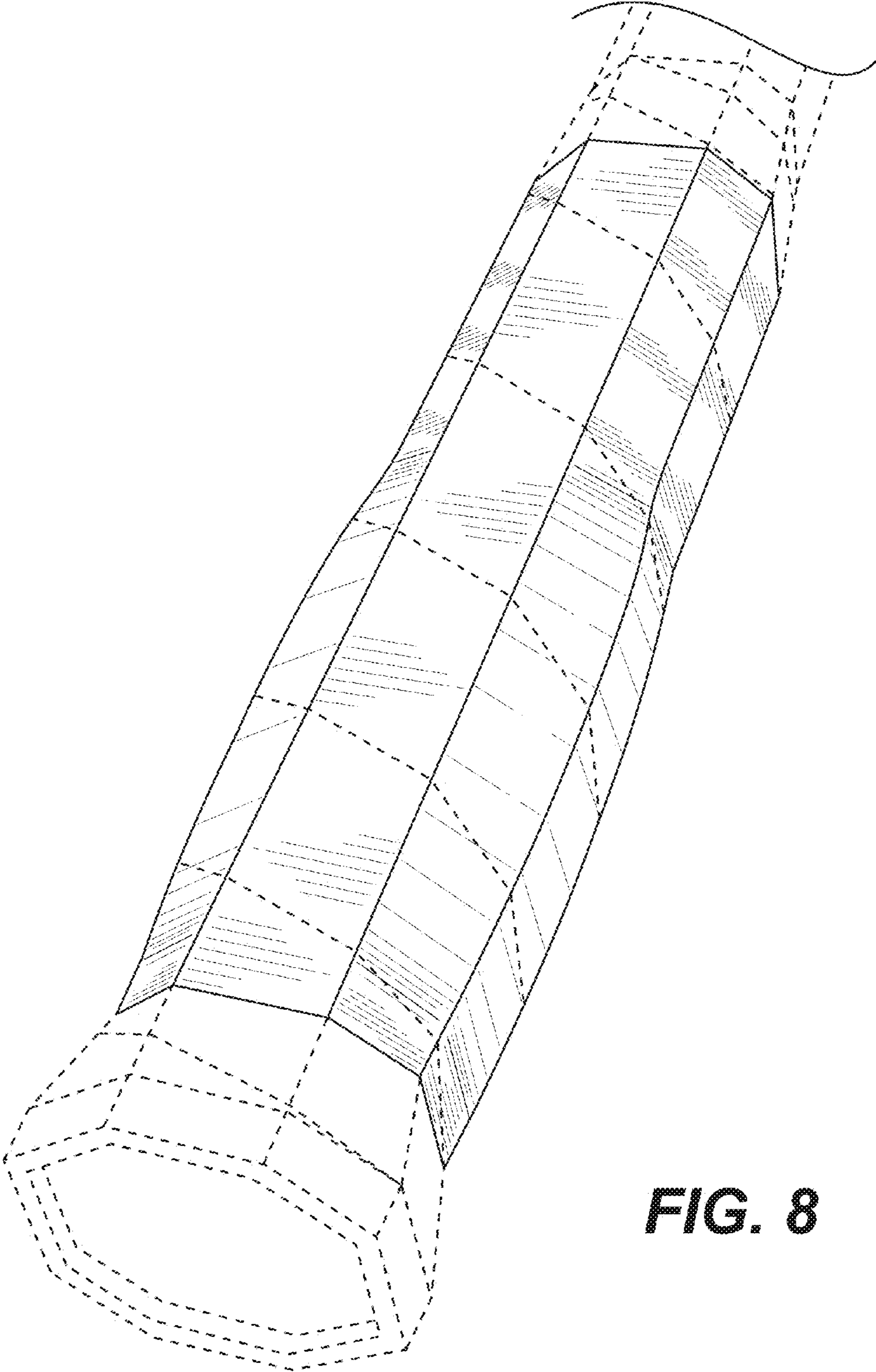
**FIG. 5**



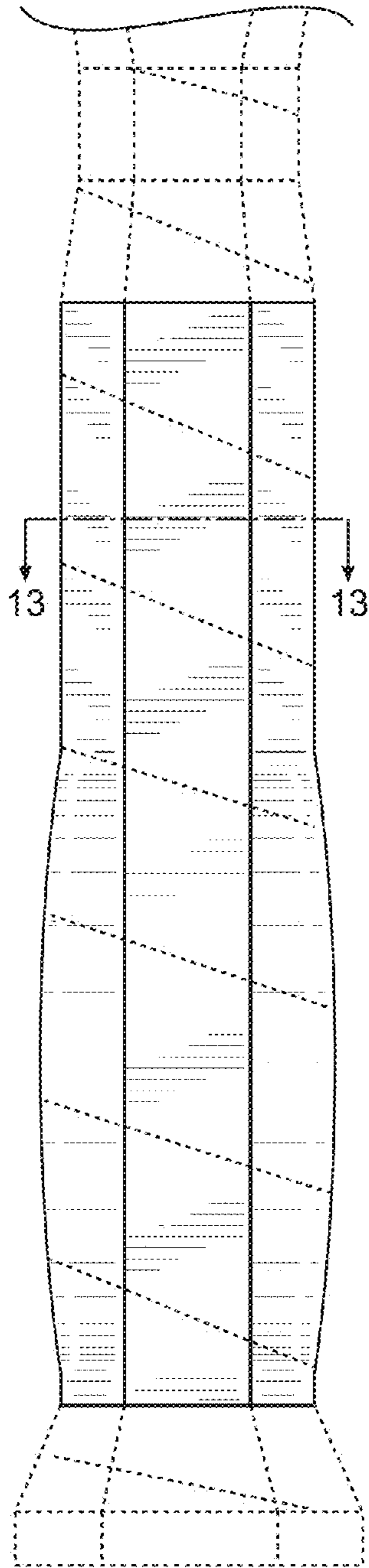
**FIG. 6**



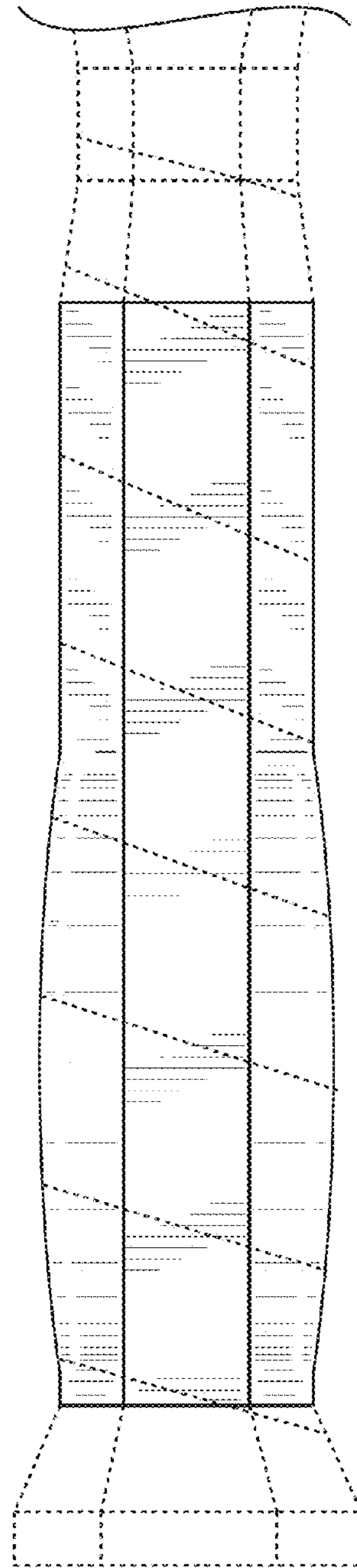
**FIG. 7**



**FIG. 8**

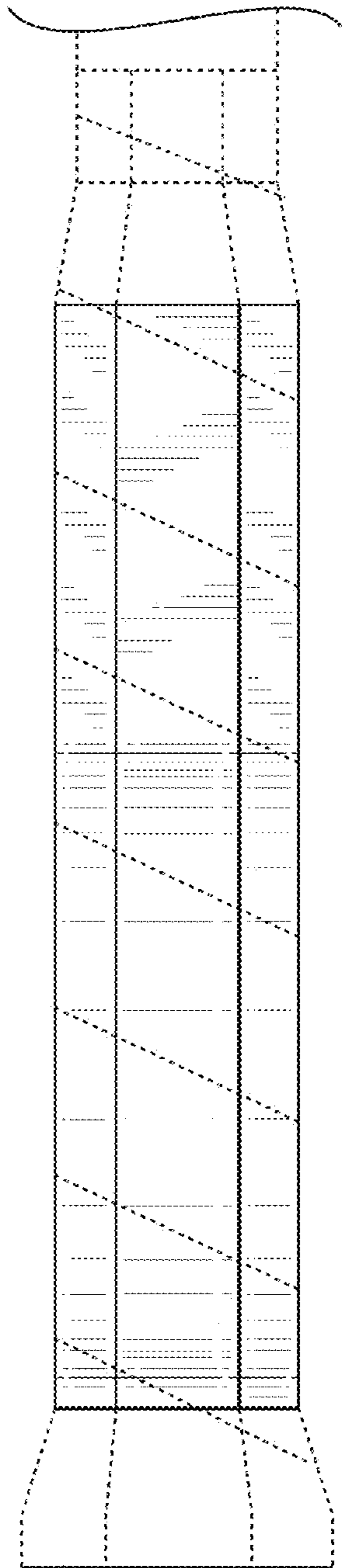


**FIG. 9**

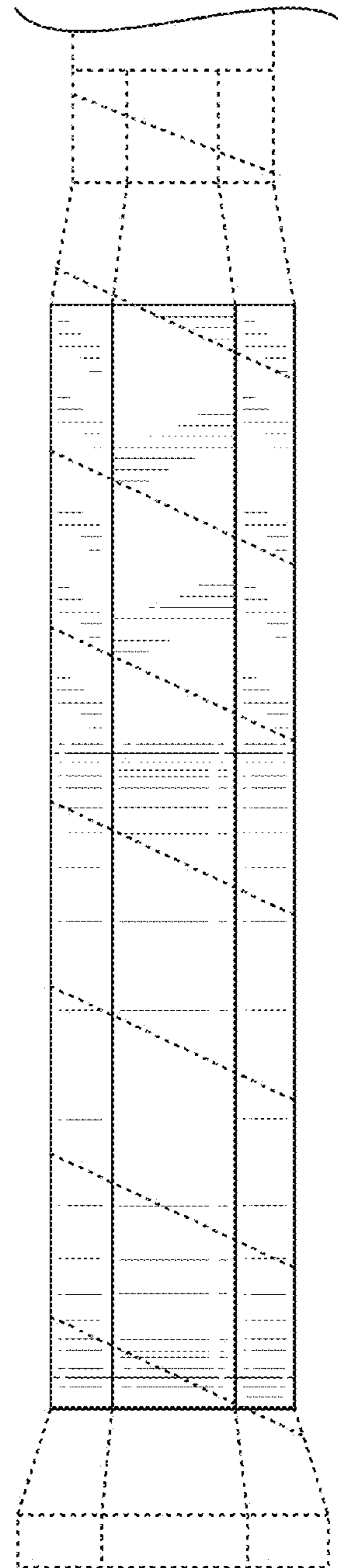


**FIG. 10**

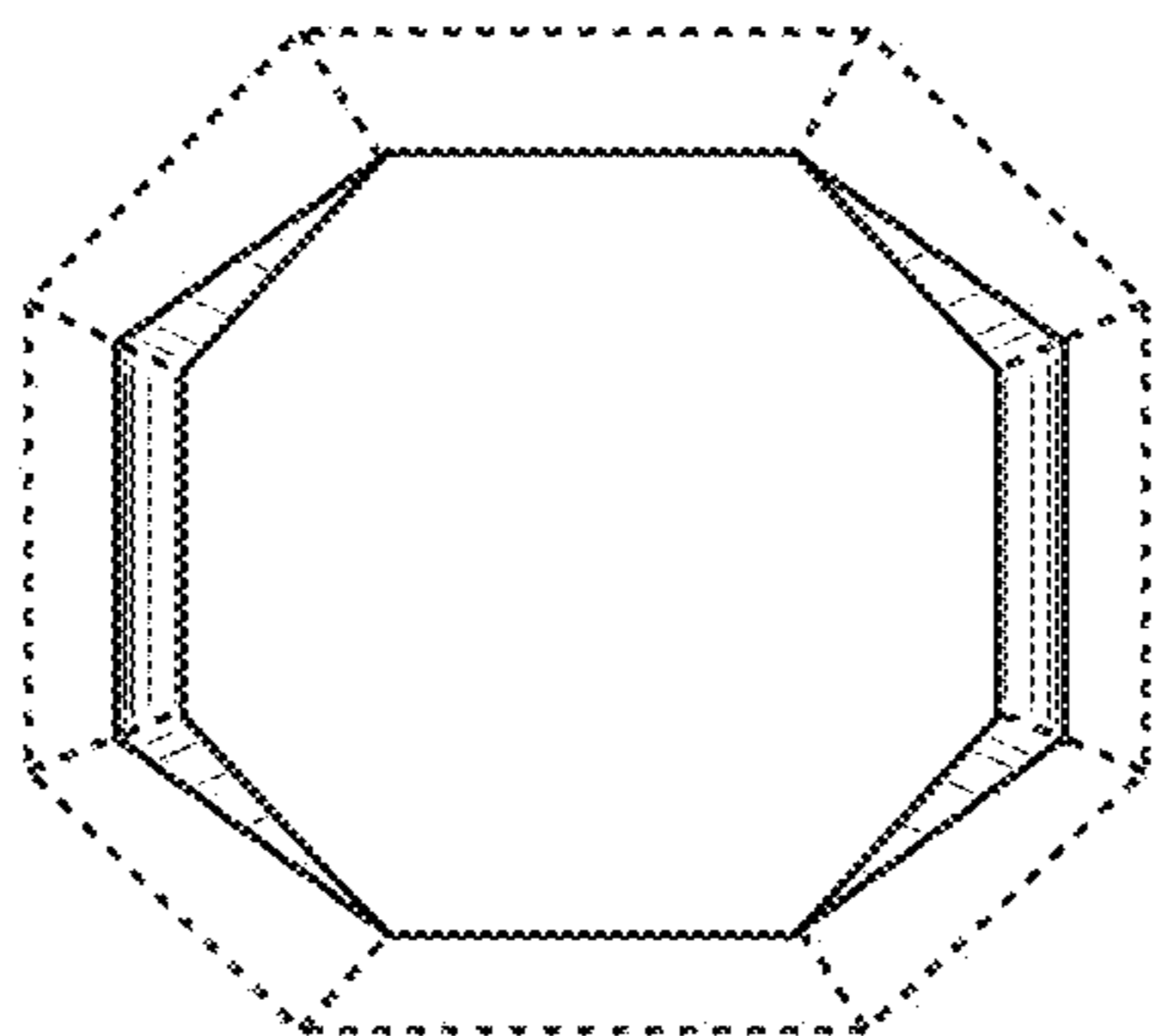




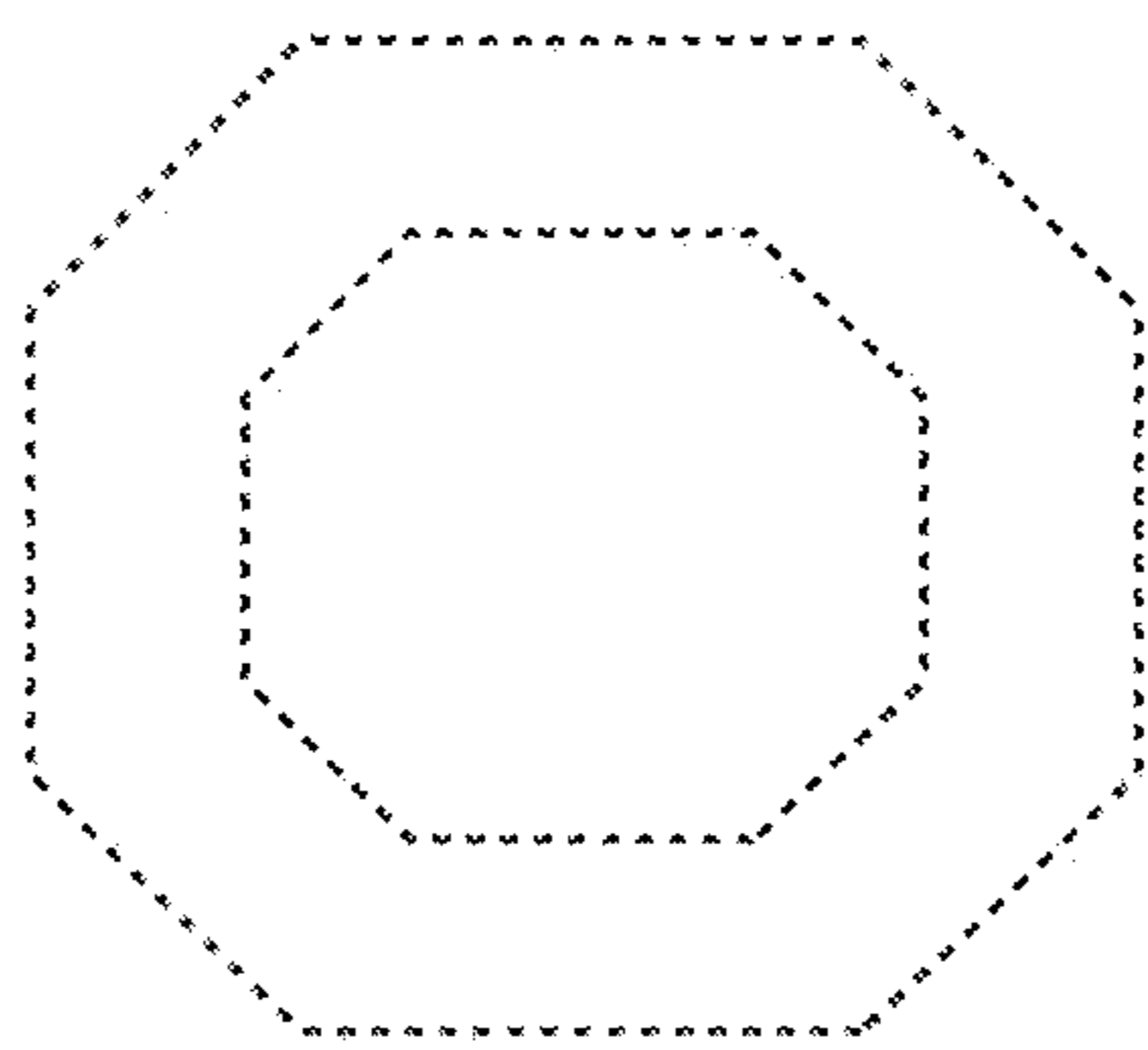
**FIG. 11**



**FIG. 12**



**FIG. 13**



**FIG. 14**