



US00D730947S

(12) **United States Design Patent**
Fukuchi et al.

(10) **Patent No.:** **US D730,947 S**
(45) **Date of Patent:** **** Jun. 2, 2015**

(54) **METER INSTRUMENT PANEL**
(71) Applicant: **Iseki & Co., Ltd**, Matsuyama-shi,
Ehime-ken (JP)
(72) Inventors: **Kazunori Fukuchi**, Tobe-cho (JP);
Takehumi Kato, Tobe-cho (JP);
Hirofumi Tsuchiya, Tobe-cho (JP);
Teruki Matsukawa, Tobe-cho (JP);
Narutoshi Ishioka, Tobe-cho (JP)
(73) Assignee: **Iseki & Co., Ltd.** (JP)

D428,022 S * 7/2000 Altmann et al. D15/28
D434,425 S * 11/2000 Rossow et al. D15/28
D436,604 S * 1/2001 Rossow et al. D15/28
D439,257 S * 3/2001 Rossow et al. D15/28
D452,693 S * 1/2002 Mitchell D14/492
D519,132 S * 4/2006 Laux et al. D15/28
D527,665 S * 9/2006 Koide et al. D10/103
D529,052 S * 9/2006 Dolesh et al. D15/28
D543,558 S * 5/2007 Dolesh et al. D15/28
D589,388 S * 3/2009 Sauter D10/102
D596,145 S * 7/2009 Vasichek et al. D13/177
D596,146 S * 7/2009 Vasichek et al. D13/177
D654,415 S * 2/2012 Mizuno D12/192
D673,487 S * 1/2013 Hanson et al. D12/192

(**) Term: **14 Years**

* cited by examiner

(21) Appl. No.: **29/491,050**

Primary Examiner — Mark Goodwin

(22) Filed: **May 16, 2014**

(74) *Attorney, Agent, or Firm* — Finnegan, Henderson,
Farabow, Garrett & Dunner, LLP

(30) **Foreign Application Priority Data**

Nov. 20, 2013 (JP) 2013-27188

(51) **LOC (10) Cl.** **15-03**

(52) **U.S. Cl.**
USPC **D15/28**

(58) **Field of Classification Search**
USPC D15/10, 17, 22–26, 28; D12/190, 192;
D10/103, 109, 125; D14/101, 102,
D14/113, 150, 247; D34/35; 180/90, 287;
296/70

See application file for complete search history.

(56) **References Cited**

U.S. PATENT DOCUMENTS

4,447,860 A * 5/1984 Stone et al. 362/30
D378,500 S * 3/1997 Nakai et al. D10/125
D382,569 S * 8/1997 Esposito D15/28
D412,157 S * 7/1999 Stevenson D14/443
D427,613 S * 7/2000 Altmann et al. D15/28

(57) **CLAIM**

The ornamental design for a meter instrument panel, as shown and described.

DESCRIPTION

FIG. 1 is a front elevation view of a meter instrument panel showing our new design;
FIG. 2 is a left side view thereof;
FIG. 3 is a right side view thereof;
FIG. 4 is the rear elevation view thereof;
FIG. 5 is a top plan view thereof;
FIG. 6 is a bottom view thereof; and,
FIG. 7 is a cross-section view of the panel taken along the line 7-7 shown in FIG. 1.

The broken lines of uneven length set out the outer boundary of our design. The broken lines of even length shown in the drawings illustrate portions of the meter instrument panel that form no part of the claimed design.

1 Claim, 5 Drawing Sheets

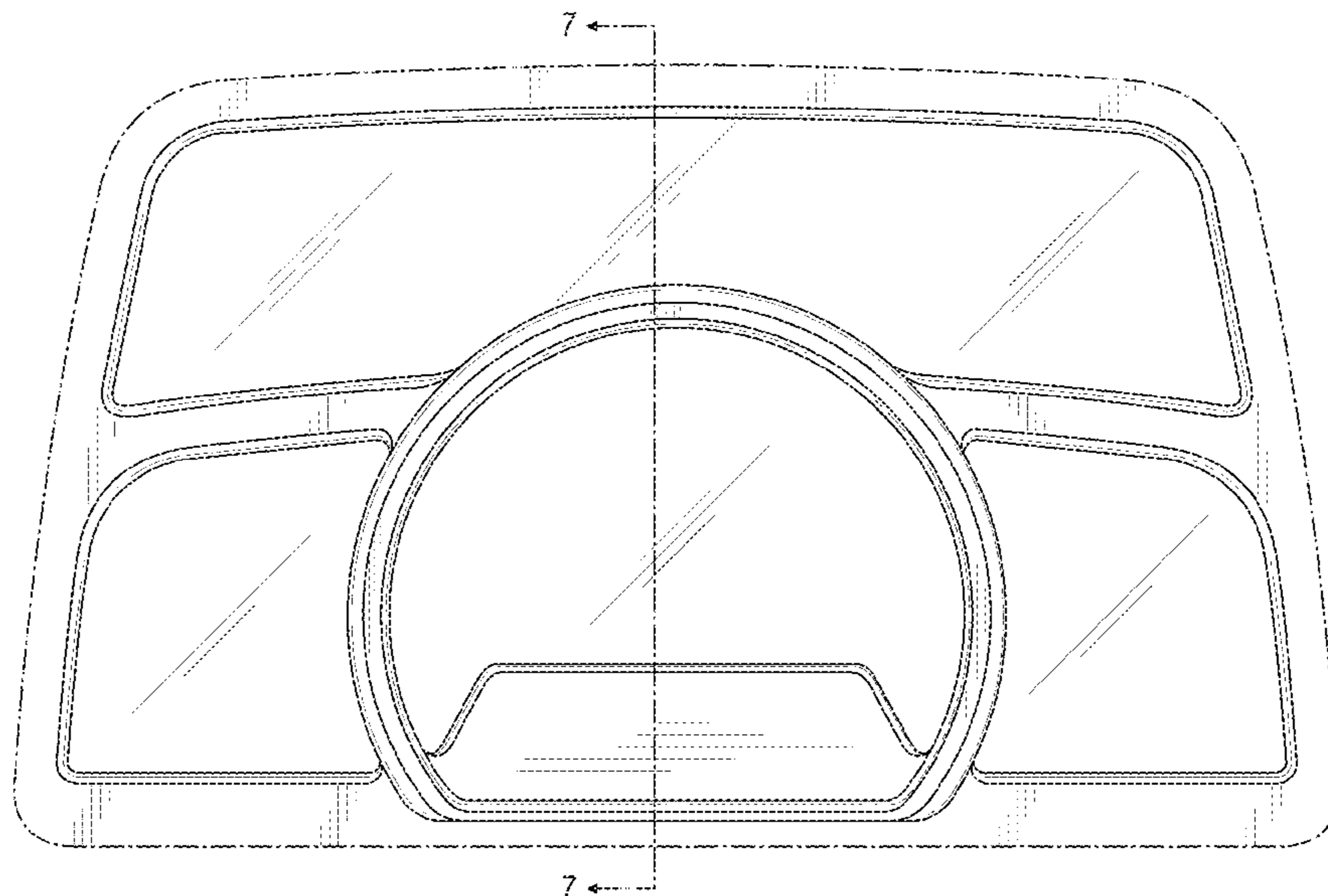

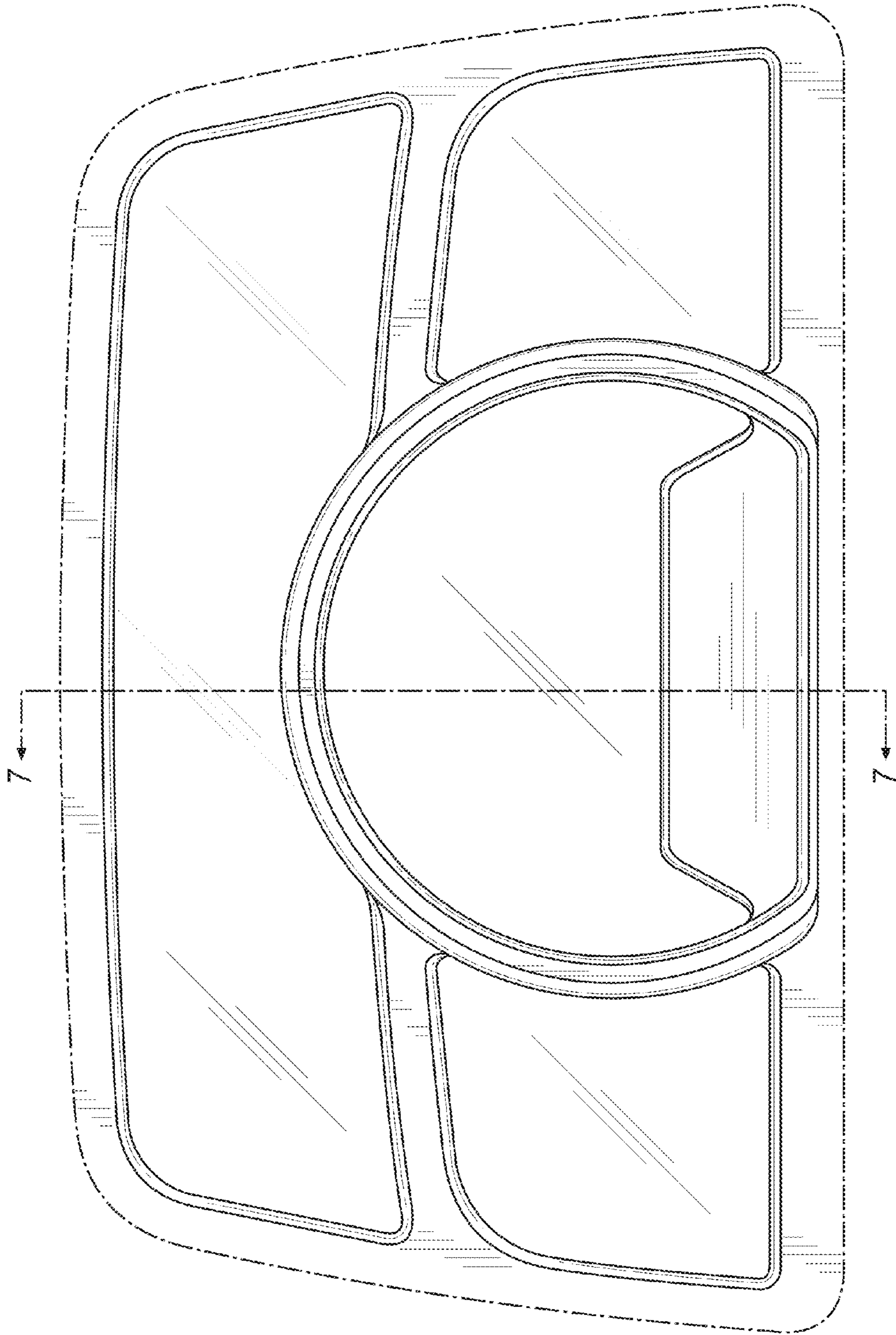

FIG. 1

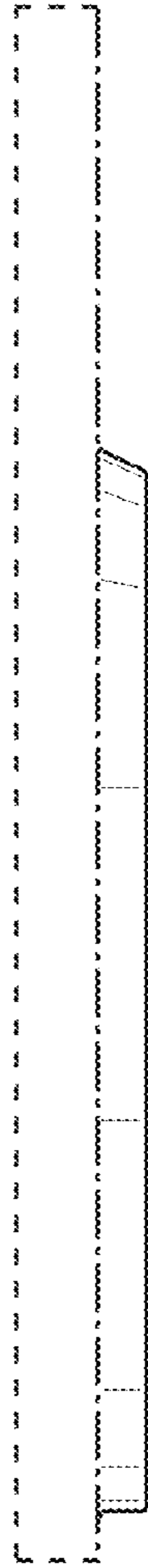

FIG. 2

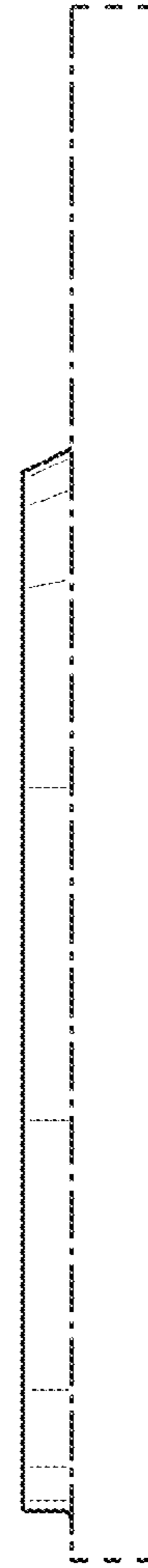

FIG. 3



FIG. 4

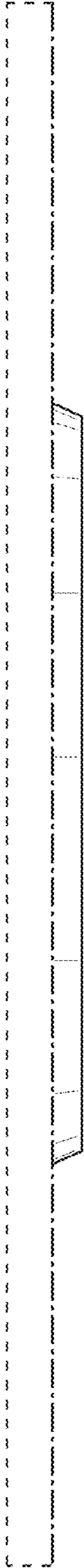

FIG. 5

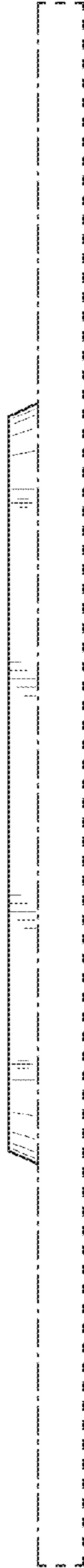

FIG. 6

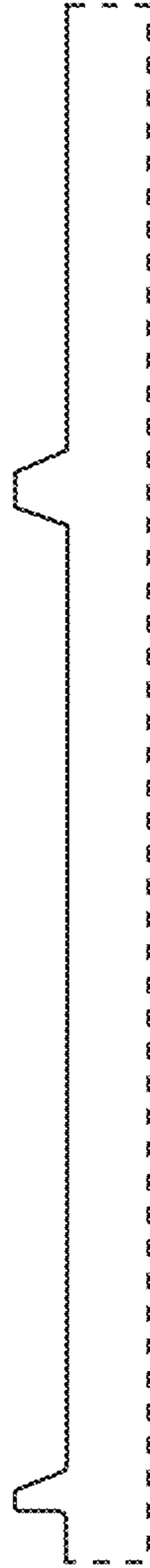

FIG. 7