

US00D730908S

(12) **United States Design Patent**
Lim et al.

(10) **Patent No.:** **US D730,908 S**
(45) **Date of Patent:** **** Jun. 2, 2015**

(54) **MEMORY CARD**

(71) Applicant: **SAMSUNG ELECTRONICS CO., LTD.**, Seoul (KR)

(72) Inventors: **Gwang-Man Lim**, Seoul (KR); **Il-Mok Kang**, Suwon-si (KR); **Seok-Jae Han**, Seoul (KR); **Sang-Chul Kang**, Hwaseong-Si (KR); **Seok-Cheon Kwon**, Yongin-Si (KR); **Seok-Chan Lee**, Hwaseong-Si (KR)

(73) Assignee: **SAMSUNG ELECTRONICS CO., LTD.**, Suwon-si (KR)

(**) Term: **14 Years**

(21) Appl. No.: **29/507,097**

(22) Filed: **Oct. 23, 2014**

(30) **Foreign Application Priority Data**

May 2, 2014 (KR) 30-2014-0022340

(51) **LOC (10) Cl.** **14-02**

(52) **U.S. Cl.**
USPC **D14/436**

(58) **Field of Classification Search**
USPC D14/435-438, 478-480; 235/441, 443, 235/487, 492, 493, 495; 361/737, 679, 752, 361/736, 728, 796, 797, 729, 730, 361/725-727; 257/678, 679, 693, E23.064; 439/946, 948, 159; 174/250, 260, 52.1, 174/52.2; 710/300-303; 438/121
CPC G06K 19/06196; G06K 19/072; G06K 19/0721; G06K 19/0722; G06K 19/0723; G06K 19/0724; G06K 19/0725; G06K 19/0726; G06K 19/0727; G06K 19/0728; G06K 19/073; G06K 19/07309; G06K 19/077; G06K 19/07701; G06K 19/07715; G06K 19/0772; G06K 19/07722; G06K 19/07724; G06K 19/07726; G06K 19/07728; G06K 19/0773; G06K 19/07735; G06K 19/07737; G06K 19/07739; G06K 19/07741; G06K

19/07743; G06K 19/07745; G06K 19/07747; G06K 19/07749; G06K 19/07758; G06K 19/07767; G06K 19/07769; G06K 19/07771; G06K 19/07773; G06K 19/07775; G06K 19/083; G06K 19/086; G06K 19/145; G06K 19/18; G06K 2215/0022; G06K 2215/0025; G06K 2215/0028; G06K 2215/0031; G06K 2215/004; G06K 2215/0082; G06F 21/77-21/80; G06F 21/85-21/88; G06F 21/00; G06Q 20/3229; G06Q 20/34; G06Q 20/341; G06Q 20/346; G06Q 20/349; G06Q 20/3563; G06Q 20/3567; G06Q 20/357; G06Q 20/3576; H05K 5/026; H05K 5/0256; H05K 5/0265; H05K 5/0269; H05K 5/0273; H05K 5/0278; H05K 5/0282; H05K 5/0286; H05K 5/0291; H05K 5/0295; H05K 5/03; H05K 5/04; H05K 5/06; H05K 5/061; H05K 5/062; H05K 5/063; H05K 5/064; H05K 5/065; H05K 5/066; H05K 5/067; H05K 5/068; H05K 5/069; H05K 7/00; H05K 7/005; H05K 7/02; H05K 7/023; H05K 7/026; H05K 7/04; H05K 7/10; H05K 7/1418; H05K 7/142; H05K 7/1424; H05K 7/1427-7/1439; H05K 7/1461; H05K 7/1464-7/1474; H05K 7/1479; H05K 7/1481; H05K 7/1485-7/1488; H05K 2201/09745; H05K 2201/09754; H05K 2201/09763; H05K 2201/09772; H05K 2201/098; H05K 2201/09818; H05K 2201/10; H05K 2201/10007; H05K 2201/10098; H05K 2201/10143; H05K 2201/10159; H05K 2201/10174; H05K 2201/10212; H05K 2201/1028; H05K 2201/1031; H05K 2201/10431; H05K 2201/22; H05K 2201/10462; H05K 2201/10545; H05K 2201/10553; H05K 2201/1056; H05K 2201/10621; H05K 2201/10636; H05K 2203/05; H05K 3/368; H05K 3/3436; H05K 3/36; H05K 3/40; H05K 3/4007; H05K 3/4015; H05K 3/403; H05K 3/4053; H05K 3/4092; H05K 3/42; H05K 3/421; H05K 3/46; H05K 1/14; H05K 1/141; H05K 1/142; H05K 1/144; H05K 1/145; H05K 1/182; H04N 2201/216

See application file for complete search history.

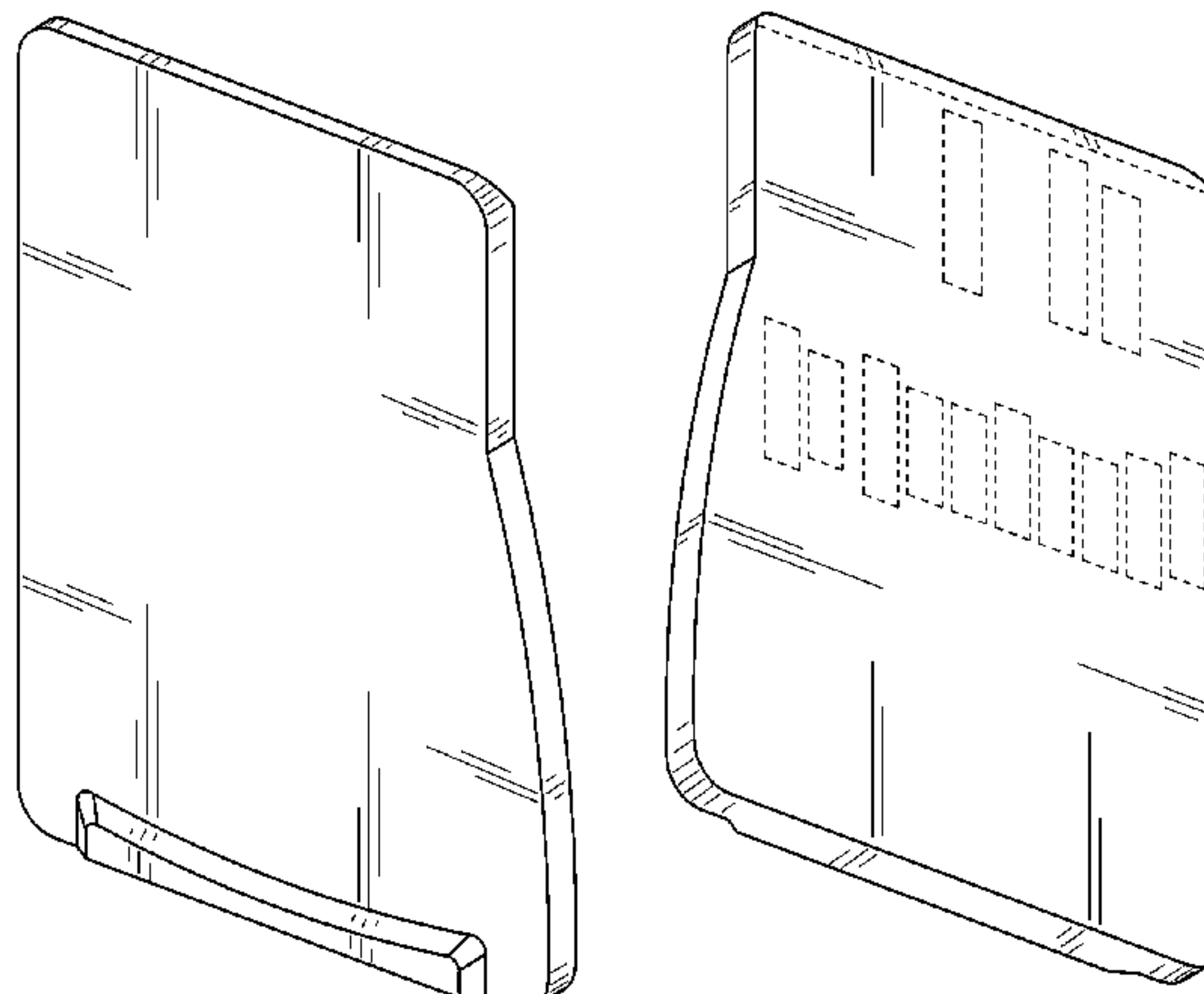

(56)

References Cited

U.S. PATENT DOCUMENTS

6,049,975 A * 4/2000 Clayton 29/832
 D493,798 S * 8/2004 Yu et al. D14/436
 6,804,119 B2 * 10/2004 Ziemkowski 361/715
 D505,959 S * 6/2005 Yamada et al. D14/436
 D507,795 S * 7/2005 Yamada et al. D14/436
 D510,579 S * 10/2005 Yamada et al. D14/436
 D510,935 S * 10/2005 Yamada et al. D14/436
 D517,559 S * 3/2006 Yu et al. D14/436
 D523,435 S * 6/2006 Takiar et al. D14/436
 7,057,268 B1 * 6/2006 d'Estries 257/679
 D525,248 S * 7/2006 Takiar D14/436
 D525,623 S * 7/2006 Takiar et al. D14/436
 D525,978 S * 8/2006 Takiar et al. D14/436
 D533,556 S * 12/2006 Yamada et al. D14/436
 D537,081 S * 2/2007 Takiar et al. D14/436
 D538,286 S * 3/2007 Takiar et al. D14/436
 7,293,716 B1 * 11/2007 Mijs 235/492
 7,633,763 B1 * 12/2009 Park et al. 361/760
 D628,202 S * 11/2010 Pomerantz et al. D14/436
 D638,431 S * 5/2011 Pomerantz et al. D14/436
 D669,478 S * 10/2012 Lepp et al. D14/436
 D669,479 S * 10/2012 Lepp et al. D14/436
 8,319,352 B2 * 11/2012 Shinohara et al. 257/777
 8,649,820 B2 * 2/2014 Schwandt et al. 455/557
 8,690,283 B2 * 4/2014 Pomerantz et al. 347/14
 2004/0259291 A1 * 12/2004 Takiar 438/113
 2005/0011671 A1 * 1/2005 Takiar et al. 174/256
 2006/0003609 A1 * 1/2006 Hwang 439/76.1
 2006/0014434 A1 * 1/2006 Yamamoto et al. 439/630
 2006/0124739 A1 * 6/2006 Kojima et al. 235/441
 2006/0183378 A1 * 8/2006 Tanaka et al. 439/630
 2006/0204391 A1 * 9/2006 Zuo et al. 417/572
 2006/0226241 A1 * 10/2006 Hsu 235/492
 2006/0261489 A1 * 11/2006 Takemoto et al. 257/774
 2007/0032135 A1 * 2/2007 Tanaka et al. 439/628
 2007/0035002 A1 * 2/2007 Moto et al. 257/686
 2007/0045873 A1 * 3/2007 Takemoto 257/784
 2007/0049080 A1 * 3/2007 Anzai et al. 439/159
 2007/0049081 A1 * 3/2007 Anzai et al. 439/159
 2007/0059983 A1 * 3/2007 Anzai et al. 439/630
 2007/0072464 A1 * 3/2007 Anzai et al. 439/159
 2007/0077822 A1 * 4/2007 Tanaka et al. 439/630
 2007/0108295 A1 * 5/2007 Liu et al. 235/492
 2007/0111604 A1 * 5/2007 Ying et al. 439/630
 2007/0117276 A1 * 5/2007 Chen et al. 438/127
 2007/0126099 A1 * 6/2007 Aoki et al. 257/679
 2007/0152071 A1 * 7/2007 Jow 235/492
 2007/0155046 A1 * 7/2007 Takiar et al. 438/106
 2007/0158803 A1 * 7/2007 Chuang 257/679
 2007/0162698 A1 * 7/2007 Hsien et al. 711/115
 2007/0190836 A1 * 8/2007 Tanaka et al. 439/159
 2007/0217166 A1 * 9/2007 Liu 361/737
 2007/0224863 A1 * 9/2007 Wang 439/159
 2007/0228509 A1 * 10/2007 Okada et al. 257/503
 2007/0228536 A1 * 10/2007 Aoki 257/678
 2007/0235544 A1 * 10/2007 Chen et al. 235/486
 2007/0258220 A1 * 11/2007 Chen et al. 361/730
 2007/0259567 A1 * 11/2007 Chen et al. 439/638
 2007/0270038 A1 * 11/2007 Liu et al. 439/630
 2007/0270040 A1 * 11/2007 Jang et al. 439/660
 2008/0007932 A1 * 1/2008 Tung et al. 361/816
 2008/0065830 A1 * 3/2008 Aoki et al. 711/115
 2008/0075802 A1 * 3/2008 Chan et al. 425/588
 2008/0083828 A1 * 4/2008 Le 235/441
 2008/0096413 A1 * 4/2008 Chen 439/345

2008/0135628 A1 * 6/2008 Aoki et al. 235/492
 2008/0145968 A1 * 6/2008 Hiew et al. 438/107
 2008/0171473 A1 * 7/2008 Tanaka et al. 439/626
 2008/0186658 A1 * 8/2008 Lin 361/679
 2008/0235939 A1 * 10/2008 Hiew et al. 29/831
 2008/0273299 A1 * 11/2008 Tsai et al. 361/684
 2008/0277485 A1 * 11/2008 Park 235/492
 2008/0316696 A1 * 12/2008 Nishiyama et al. 361/684
 2008/0320195 A1 * 12/2008 Lee 710/301
 2009/0001365 A1 * 1/2009 Ye et al. 257/48
 2009/0009976 A1 * 1/2009 Nishikawa et al. 361/737
 2009/0085231 A1 * 4/2009 Chiu et al. 257/787
 2009/0085232 A1 * 4/2009 Hoo et al. 257/790
 2009/0154040 A1 * 6/2009 Tung et al. 361/56
 2009/0168322 A1 * 7/2009 Okada 361/679.32
 2009/0230534 A1 * 9/2009 Okada 257/686
 2009/0236722 A1 * 9/2009 Nishiyama et al. 257/686
 2009/0301909 A1 * 12/2009 Tang et al. 206/307.1
 2010/0055943 A1 * 3/2010 Park 439/78
 2010/0084762 A1 * 4/2010 Nishikawa et al. 257/723
 2010/0109141 A1 * 5/2010 Nishiyama et al. 257/690
 2011/0026213 A1 * 2/2011 Chang et al. 361/679.31
 2011/0092087 A1 * 4/2011 Jung et al. 439/159
 2011/0145465 A1 * 6/2011 Okada 710/301
 2011/0185098 A1 * 7/2011 Kim et al. 710/301
 2011/0233741 A1 * 9/2011 Ishii et al. 257/668
 2011/0315984 A1 * 12/2011 Suzuki et al. 257/48
 2011/0316134 A1 * 12/2011 Ishii et al. 257/676
 2012/0049378 A1 * 3/2012 Asada et al. 257/773
 2012/0079197 A1 * 3/2012 Cheng 711/115
 2012/0103838 A1 * 5/2012 Weinert 206/39
 2012/0201091 A1 * 8/2012 Hook et al. 365/201
 2012/0241933 A1 * 9/2012 Doi et al. 257/676
 2013/0027869 A1 * 1/2013 Tian et al. 361/679.31
 2013/0102170 A1 * 4/2013 Yang et al. 439/153
 2013/0288535 A1 * 10/2013 You et al. 439/634
 2014/0070381 A1 * 3/2014 Doi et al. 257/666
 2014/0099805 A1 * 4/2014 Kutchery et al. 439/76.1
 2014/0106621 A1 * 4/2014 Wu 439/630
 2014/0127947 A1 * 5/2014 Han 439/630

* cited by examiner

Primary Examiner — Susan Moon Lee

(74) Attorney, Agent, or Firm — Sughrue Mion, PLLC

(57)

CLAIM

The ornamental design for a memory card, as shown and described.

DESCRIPTION

FIG. 1 is the perspective view of a memory card showing our new design;
 FIG. 2 is a front view thereof;
 FIG. 3 is a rear view thereof;
 FIG. 4 is a left-side view thereof;
 FIG. 5 is a right-side view thereof;
 FIG. 6 is a top plan view thereof;
 FIG. 7 is a bottom plan view thereof; and,
 FIG. 8 is a rear perspective view thereof.
 Broken lines and entirely unshaded portions contained within broken line are not claimed.

1 Claim, 6 Drawing Sheets

FIG. 1

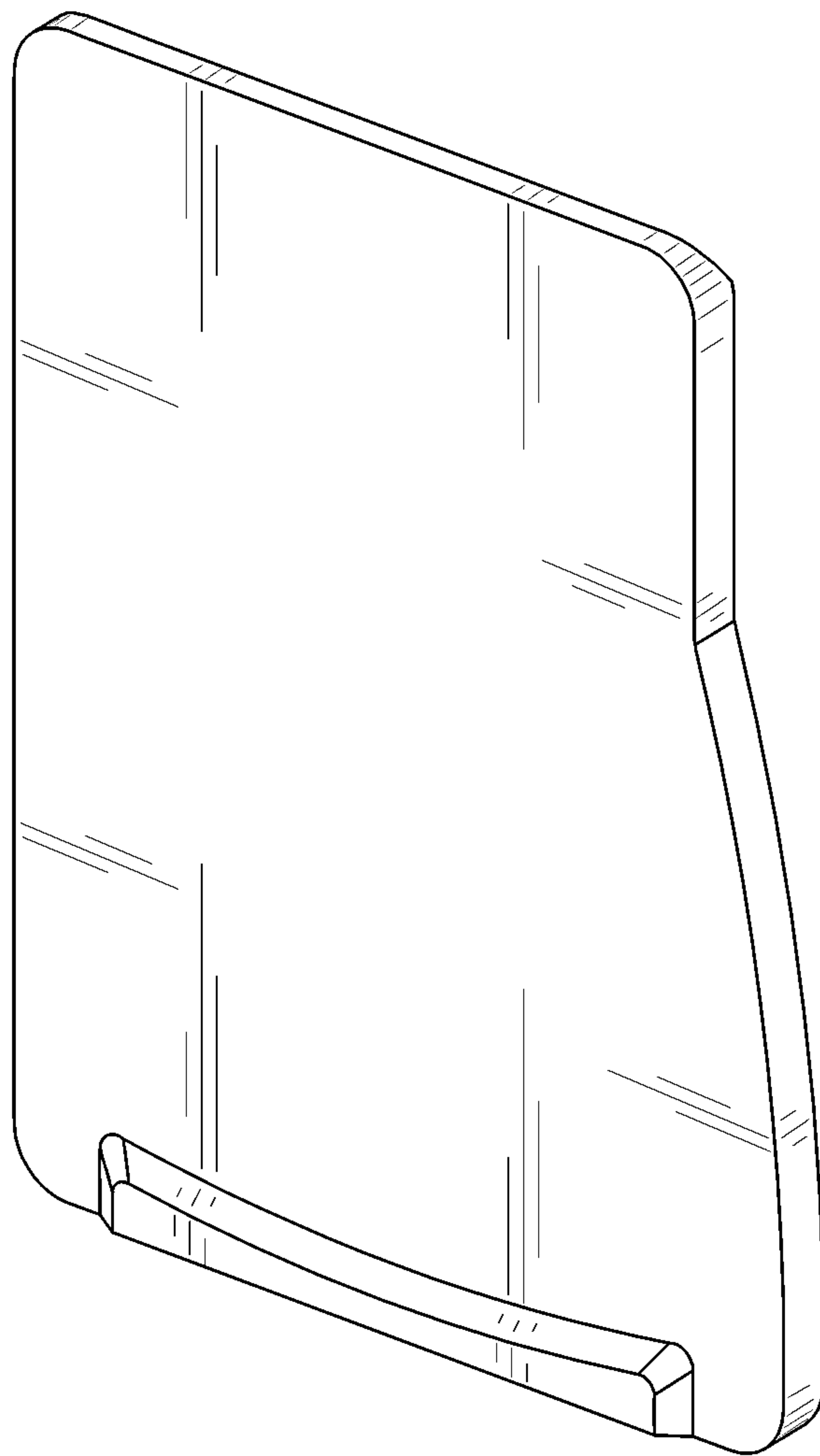

FIG. 2

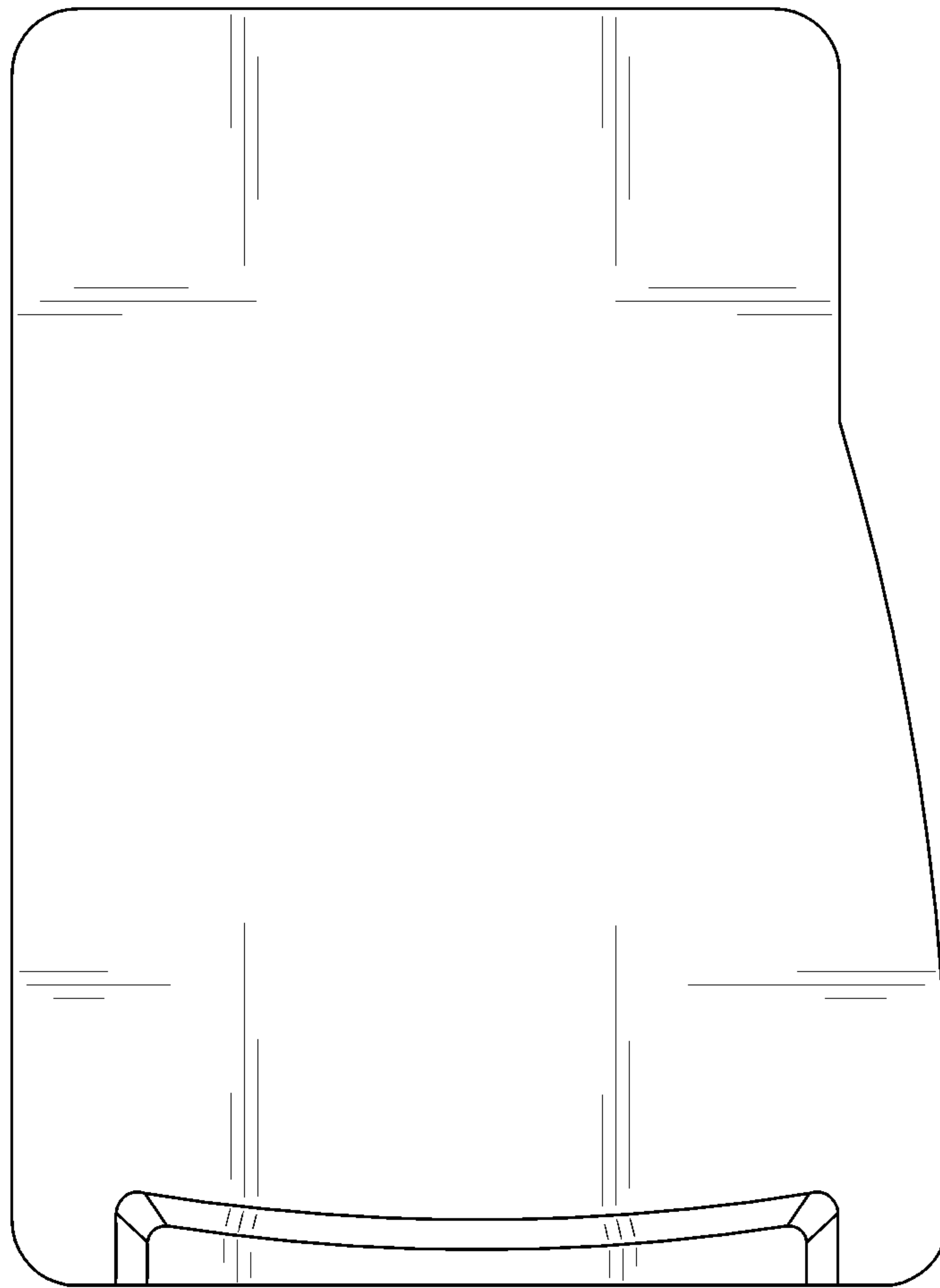

FIG. 3

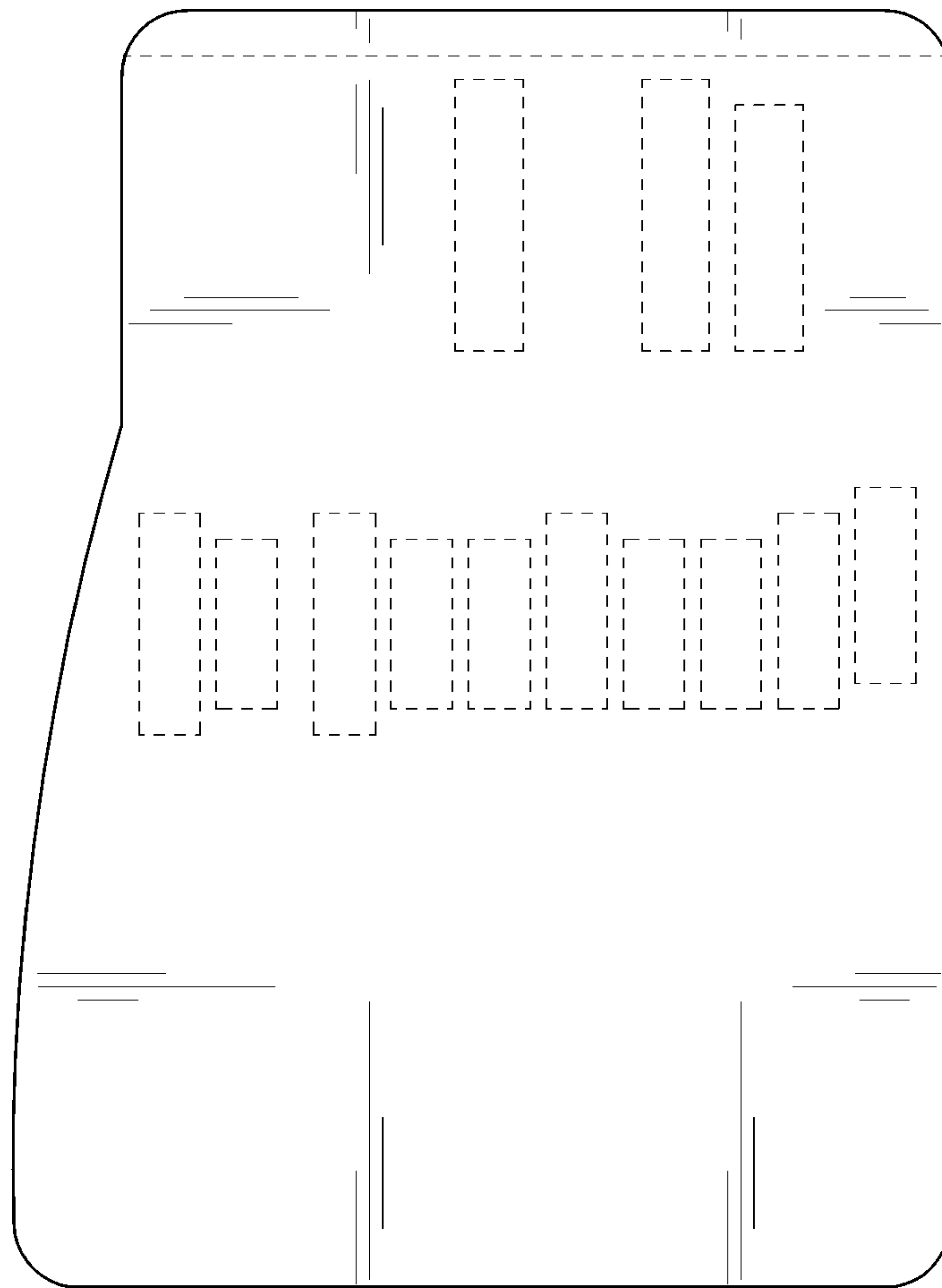

FIG. 4

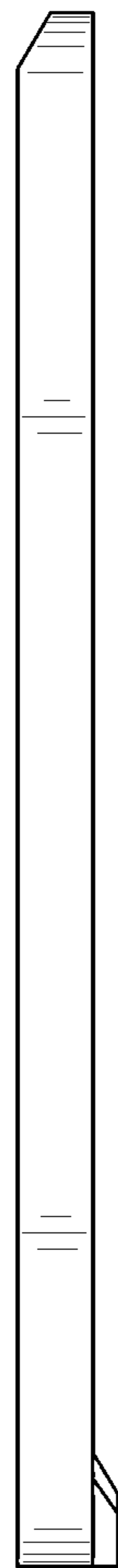

FIG. 5

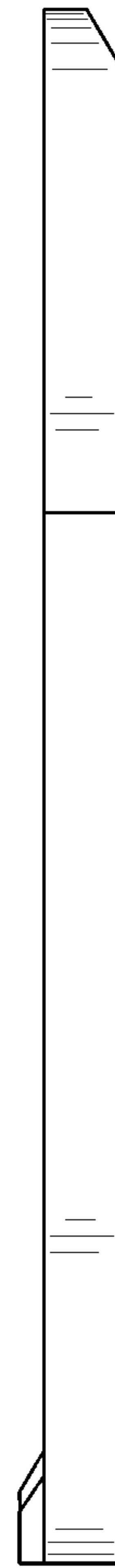

FIG. 6

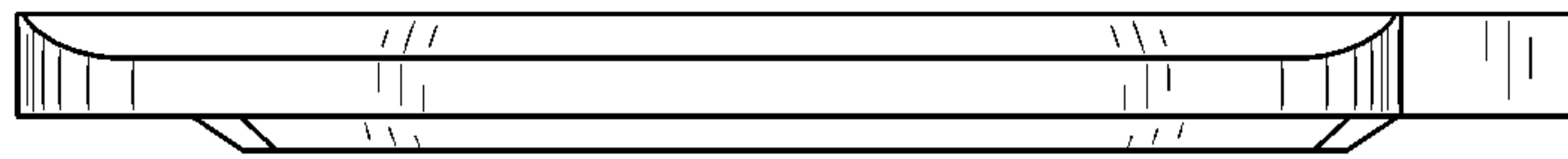

FIG. 7



FIG. 8

