



US00D730895S

(12) **United States Design Patent**
Anundi et al.

(10) **Patent No.:** **US D730,895 S**
(45) **Date of Patent:** **** Jun. 2, 2015**

(54) **DISPLAY UNIT**

(71) Applicant: **Epec Oy**, Seinäjoki (FI)

(72) Inventors: **Saara Anundi**, Vantaa (FI); **Jorma Jaakkola**, Espoo (FI); **Visa Panu Pellervo Viertola**, Seinäjoki (FI)

(73) Assignee: **EPEC OY**, Seinajoki (FI)

(**) Term: **14 Years**

(21) Appl. No.: **29/475,432**

(22) Filed: **Dec. 3, 2013**

(30) **Foreign Application Priority Data**

Jun. 3, 2013 (EM) 002248260-0001

(51) **LOC (10) Cl.** **14-02**

(52) **U.S. Cl.**
USPC **D14/371**

(58) **Field of Classification Search**
USPC D14/371-375, 125-129, 336, 337;
341/12; 345/104, 156, 168, 173;
348/180, 184, 325, 739; 349/1, 2, 11,
349/62; 361/679.05-679.07, 679.21;
D6/300, 308

See application file for complete search history.

(56) **References Cited**

U.S. PATENT DOCUMENTS

D395,454 S *	6/1998	Hayashi	D20/10
D457,504 S *	5/2002	Hori et al.	D14/126
D494,174 S *	8/2004	Hsu Li	D14/374
D579,930 S *	11/2008	Maskatia	D14/341
D582,917 S *	12/2008	Wada	D14/371
D596,173 S *	7/2009	Arfin	D14/307
D640,252 S *	6/2011	Kuroda et al.	D14/307

* cited by examiner

Primary Examiner — Freda S Nunn

(74) *Attorney, Agent, or Firm* — Nixon & Vanderhye PC

(57) **CLAIM**

The ornamental design for “display unit,” as shown and described.

DESCRIPTION

FIG. 1 is a front perspective view of a display unit in accordance with our new design;
FIG. 2 is a rear perspective view thereof;
FIG. 3 is a front elevation view thereof;
FIG. 4 is a rear elevation view thereof;
FIG. 5 is a top plan view thereof;
FIG. 6 is a bottom plan view thereof; and,
FIG. 7 is a left side view, the right side being a mirror image view thereof.
Portions of the design shown in broken lines are for reference only and form no part of the claimed design.

1 Claim, 6 Drawing Sheets

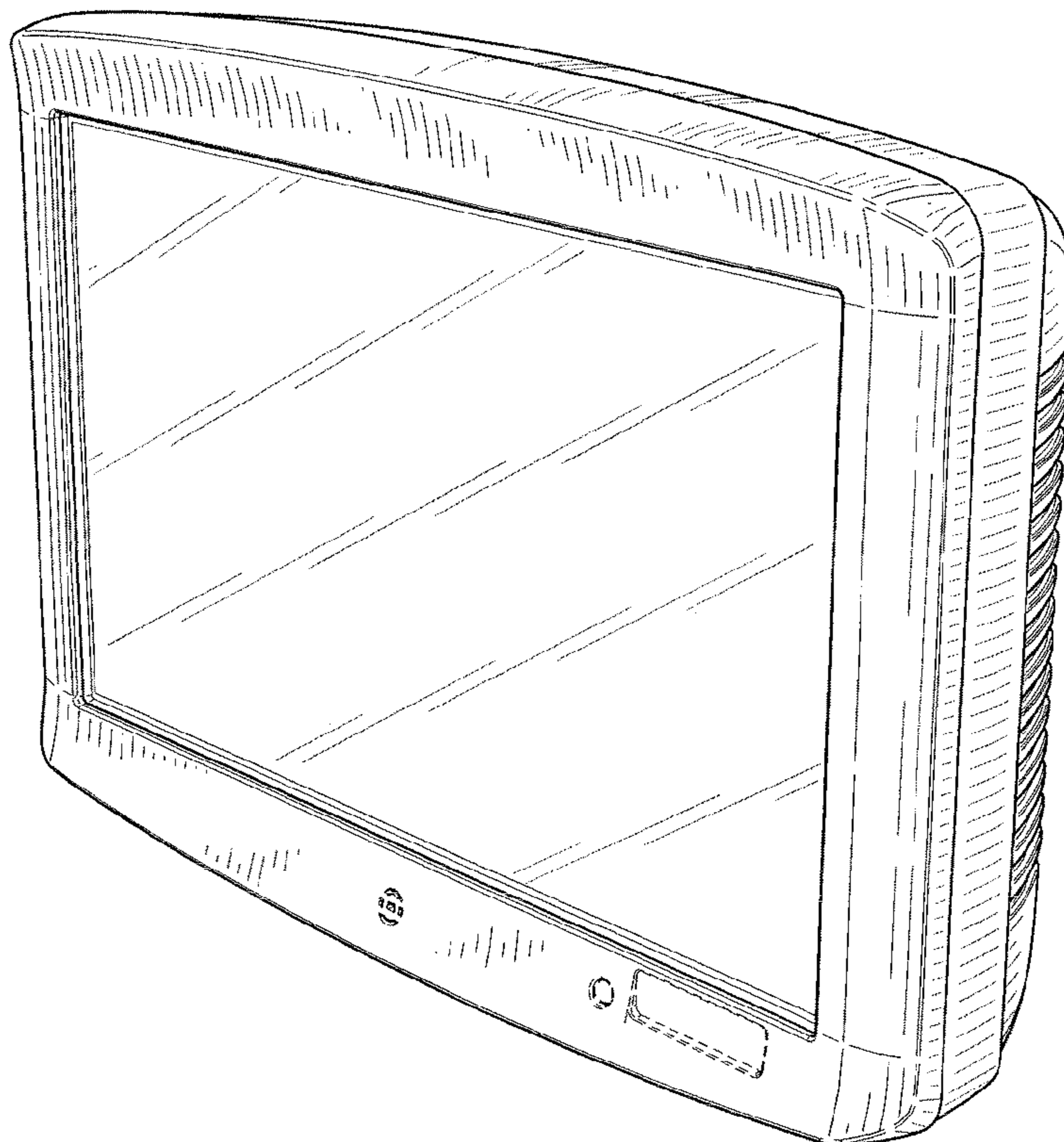

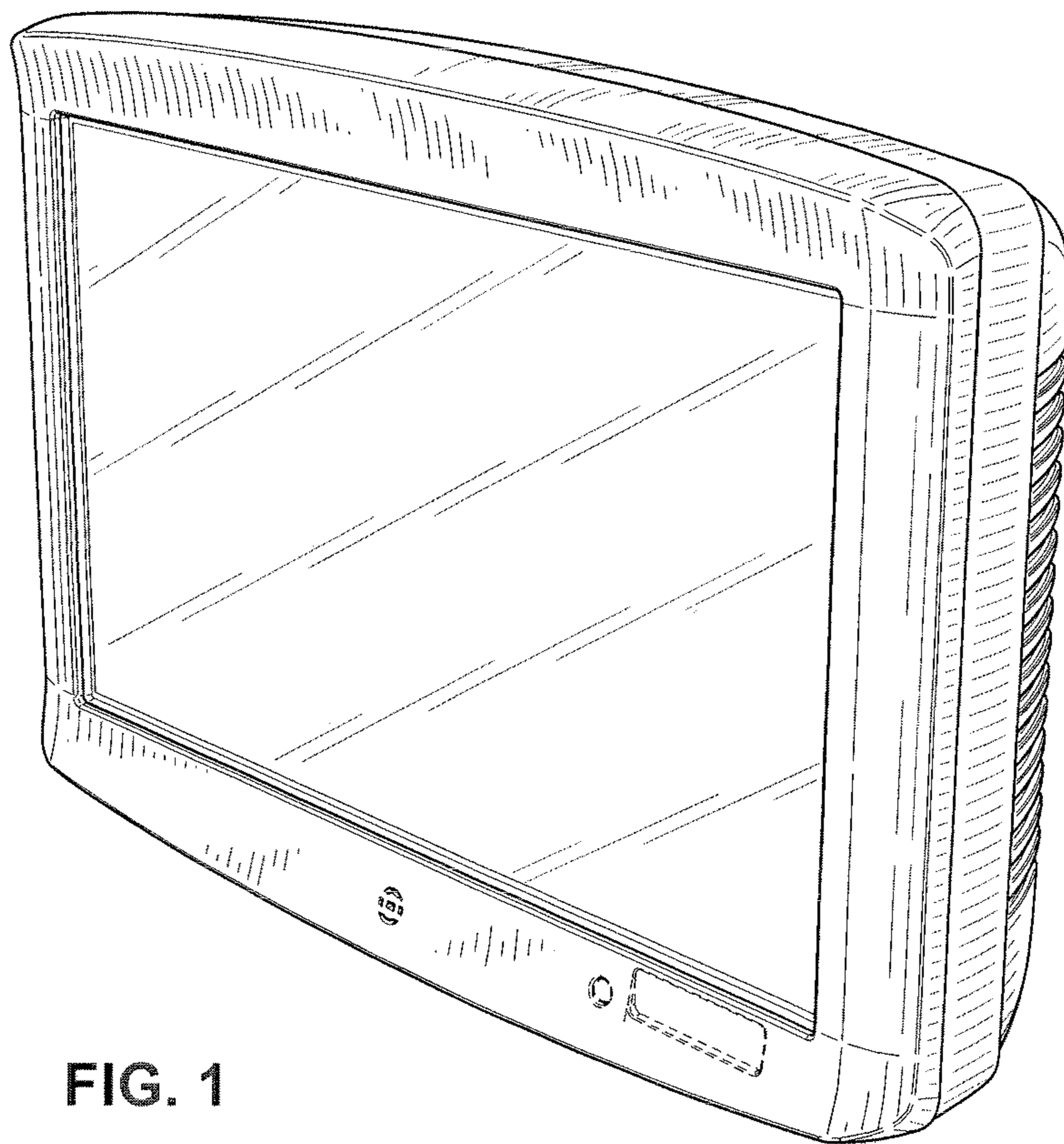

FIG. 1

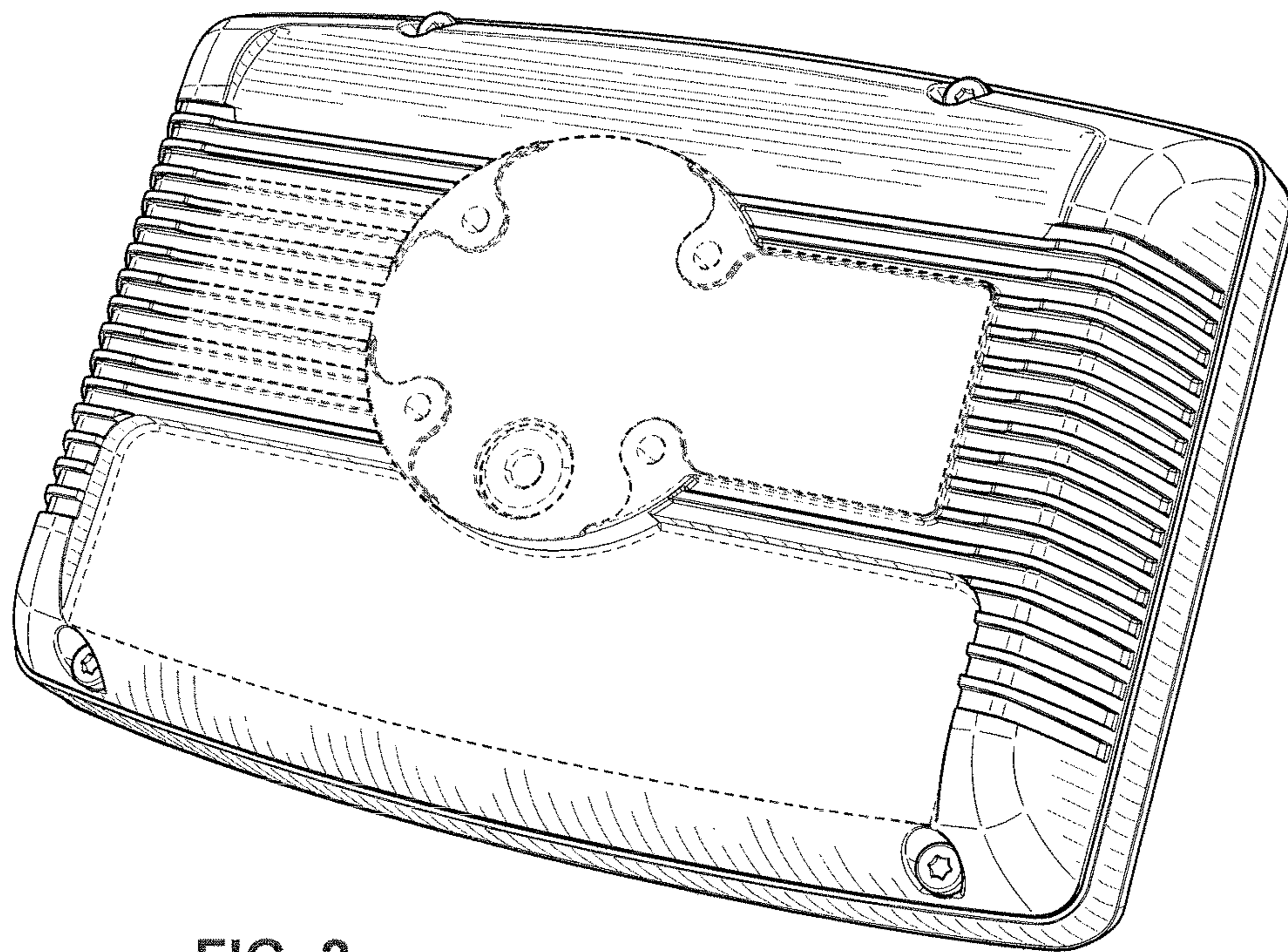

FIG. 2

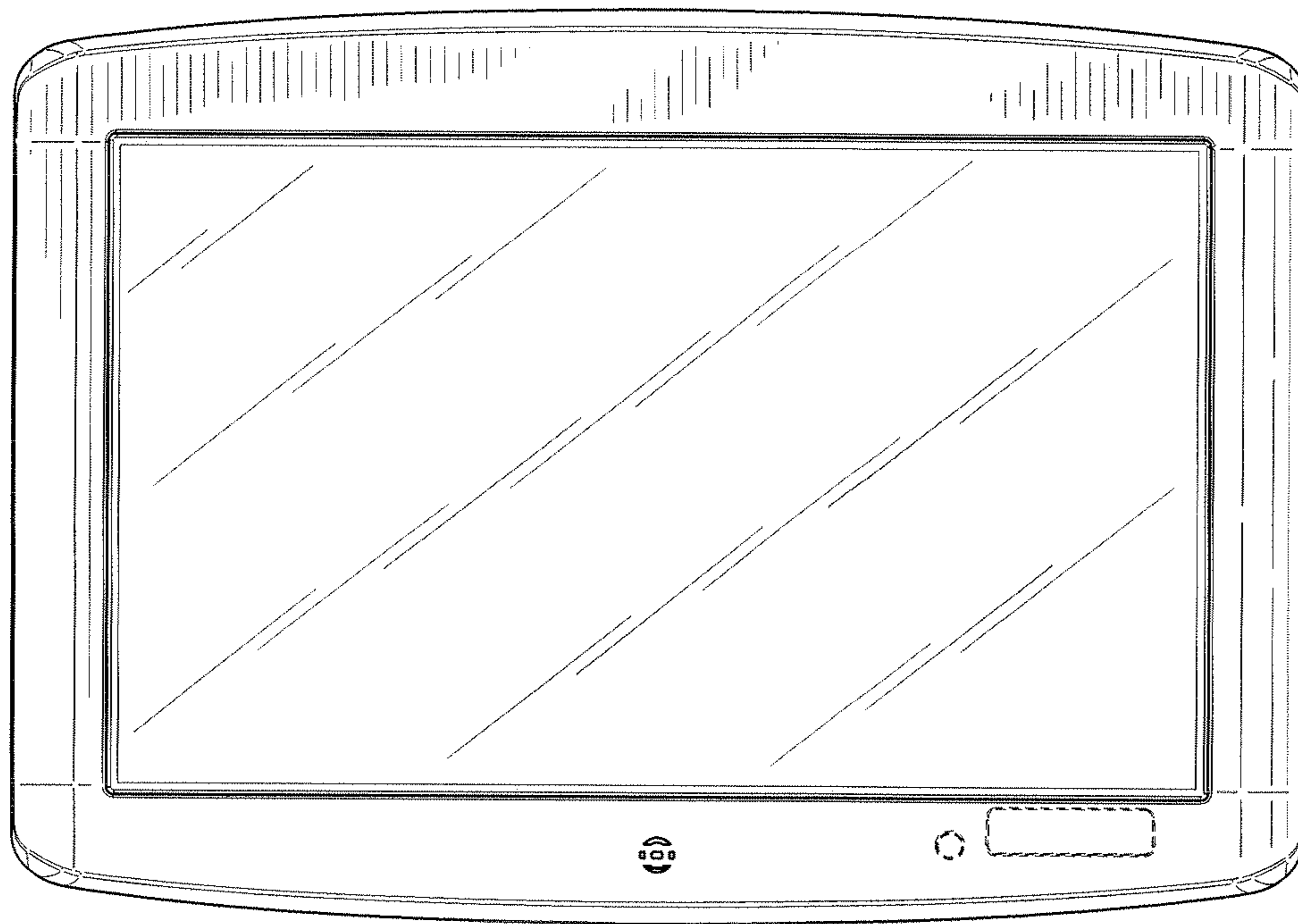

FIG. 3

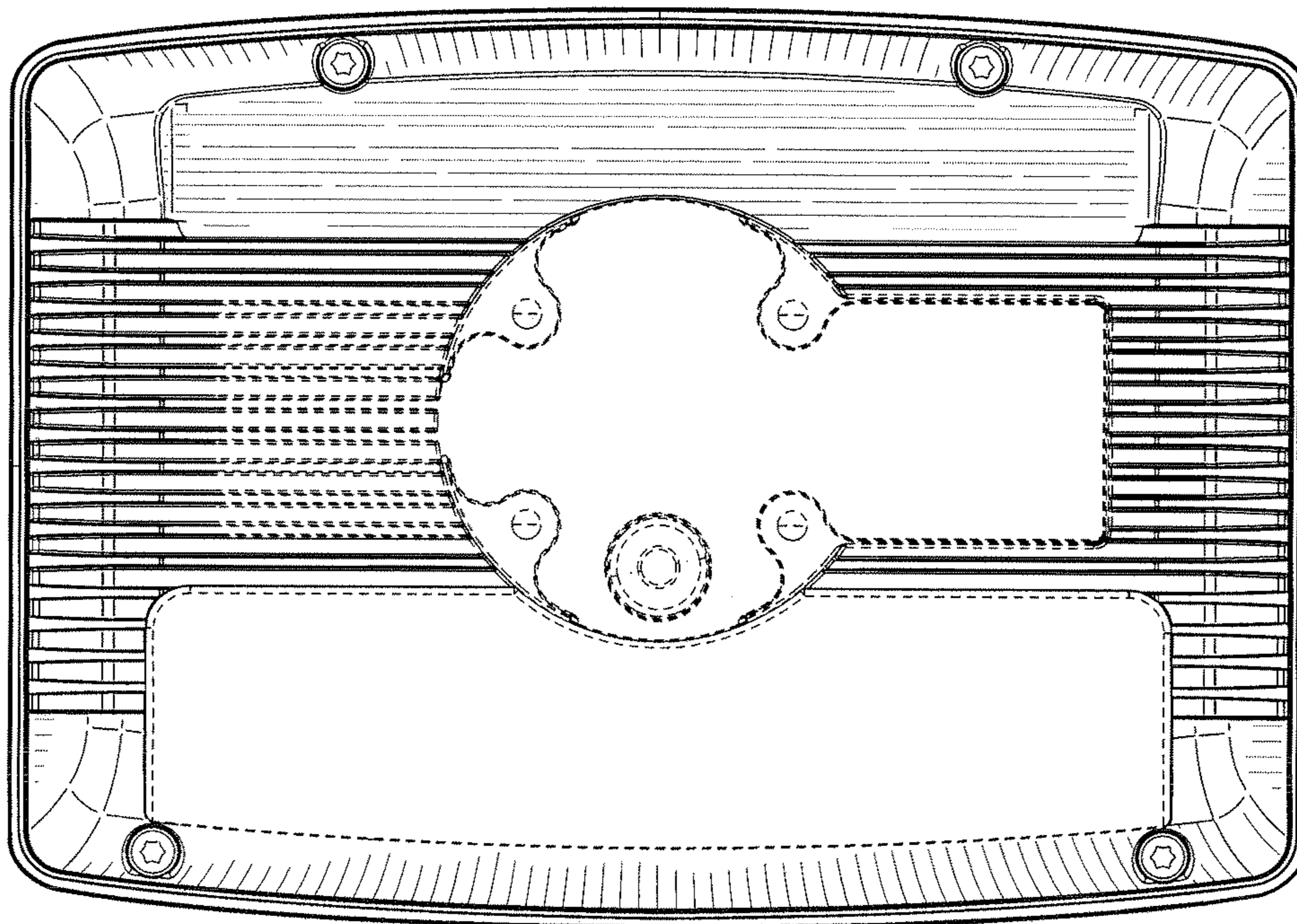

FIG. 4

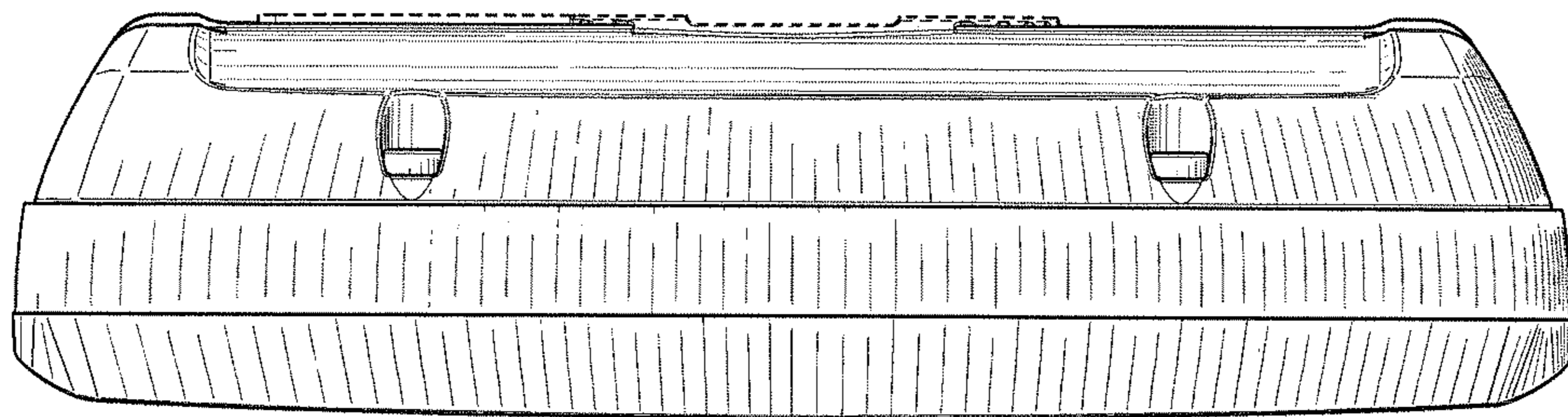

FIG. 5

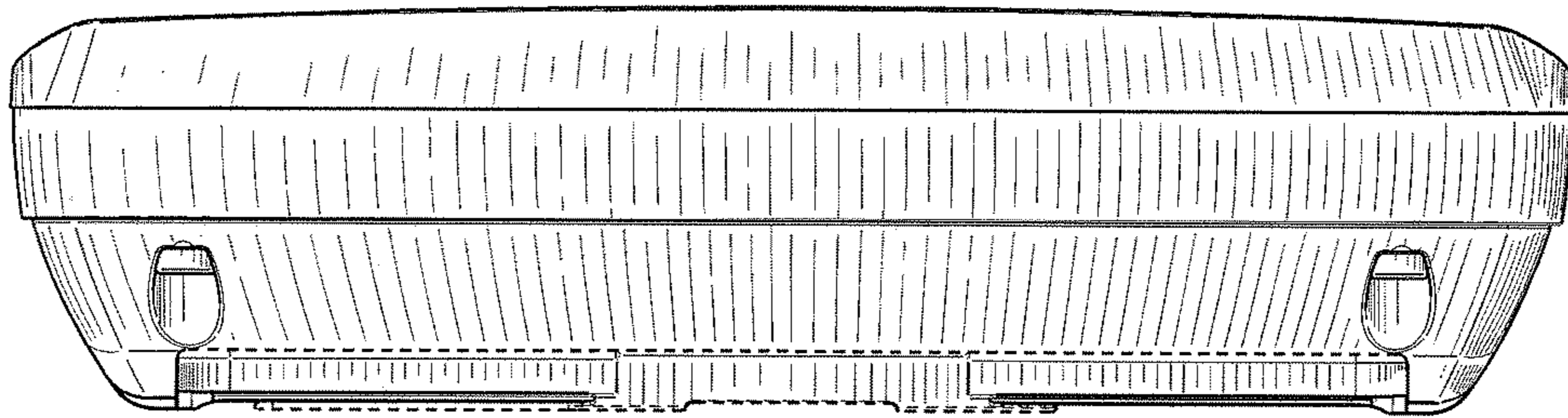

FIG. 6

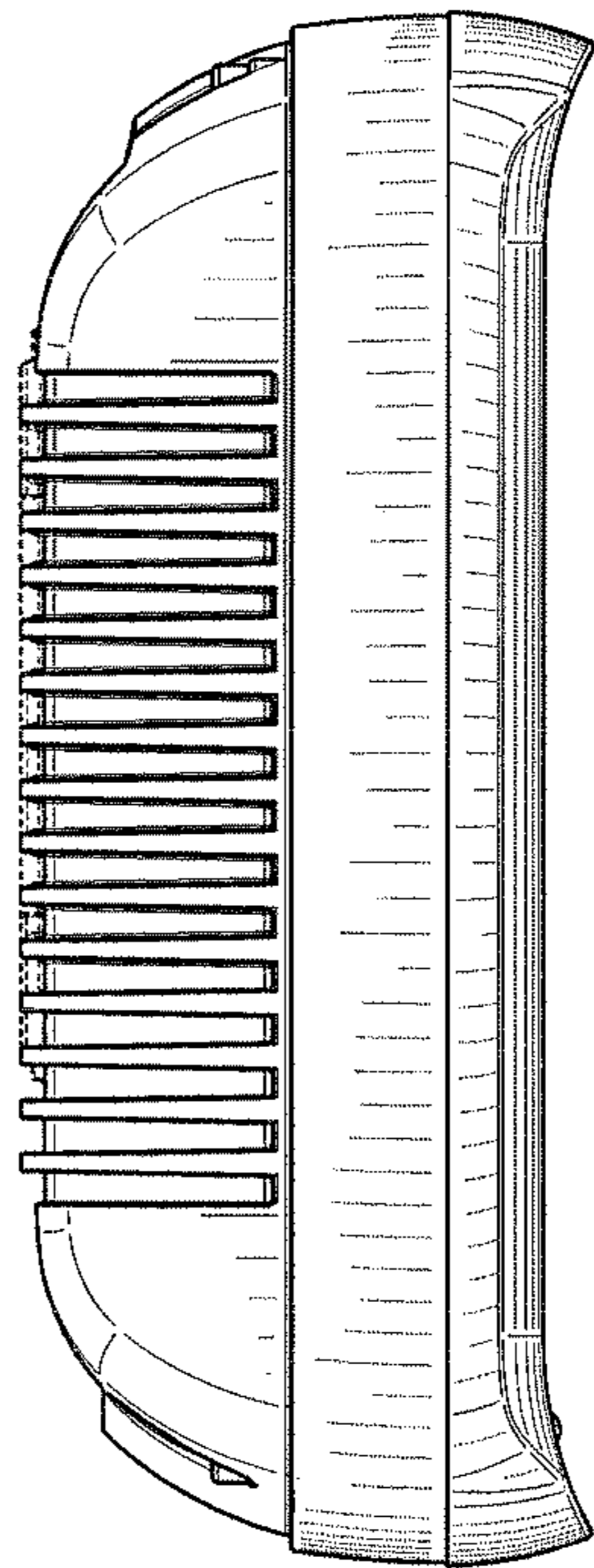

FIG. 7