



US00D730888S

(12) **United States Design Patent**
Malsan

(10) **Patent No.:** **US D730,888 S**
(45) **Date of Patent:** **** Jun. 2, 2015**

- (54) **DISPLAY STAND FOR PORTABLE ELECTRONIC DEVICES**
- (71) Applicant: **Kenneth Richard Malsan**, Rexford, NY (US)
- (72) Inventor: **Kenneth Richard Malsan**, Rexford, NY (US)
- (73) Assignee: **Kenneth R. Malsan**, Rexford, NY (US)
- (**) Term: **14 Years**
- (21) Appl. No.: **29/463,171**
- (22) Filed: **Aug. 19, 2013**
- (51) **LOC (10) Cl.** **14-03**
- (52) **U.S. Cl.**
USPC **D14/253**
- (58) **Field of Classification Search**
USPC D14/137, 140, 140.8, 142, 204, 209.1, D14/217, 221, 243–256, 434, 440, 444–447, D14/238.1; D8/400–404, 499; D2/861; D3/215, 218, 304, 269; D6/467, 300, D6/310, 553–574; D25/318; 292/342, 343; 248/188.2; 348/373, 376; D12/415, D12/411, 416, 422; D19/87, 90; 455/573, 455/575.1, 575.9; D10/74
See application file for complete search history.

- D676,832 S * 2/2013 Akana et al. D14/217
- D699,246 S * 2/2014 Ringlein D14/447
- D702,665 S * 4/2014 Kim D14/217
- D703,215 S * 4/2014 Alesi et al. D14/447
- D704,633 S * 5/2014 Ryu et al. D13/108
- D705,158 S * 5/2014 Gengler D13/107
- D706,784 S * 6/2014 Mills D14/447
- 2014/0125283 A1 * 5/2014 Yang 320/115

* cited by examiner

Primary Examiner — Susan Bennett Hattan
Assistant Examiner — Janice Hallmark

(57) **CLAIM**

The ornamental design for a display stand for portable electronic devices, as shown and described.

DESCRIPTION

FIG. 1 is a front right side perspective view of a display stand for portable electronic devices showing my new design; FIG. 2 is a front left side perspective view thereof; FIG. 3 is a front elevation view thereof; FIG. 4 is a front perspective view thereof; FIG. 5 is a right side elevation view thereof; FIG. 6 is a left side elevation view thereof; FIG. 7 is a bottom perspective view thereof; FIG. 8 is a bottom plan view thereof; FIG. 9 is a top plan view thereof; FIG. 10 is a back elevation view thereof; FIG. 11 is a back right perspective view thereof; FIG. 12 is a front right side perspective view of a display stand for portable electronic devices as shown in an environment of use with a mobile phone mounted in the portrait position; FIG. 13 is a right side elevation view thereof; FIG. 14 is a front elevation view thereof; FIG. 15 is a side elevation view of a display stand for portable electronic devices shown in an environment of use with a mobile phone mounted in the landscape position; and, FIG. 16 is a front elevation view thereof. The broken line showing of the mounted mobile phone display item in FIGS. 12 to 16 is for the purpose of illustrating an environmental structure and forms no part of the claimed design.

1 Claim, 8 Drawing Sheets

(56) **References Cited**

U.S. PATENT DOCUMENTS

- D465,532 S * 11/2002 Hussaini et al. D21/333
- D474,736 S * 5/2003 Sagawa D13/108
- D574,375 S * 8/2008 Prest et al. D14/253
- D616,431 S * 5/2010 Hijmans D14/253
- D636,395 S * 4/2011 Anderson et al. D14/434
- D648,325 S * 11/2011 Akana et al. D14/217
- D648,725 S * 11/2011 Akana et al. D14/434
- D652,422 S * 1/2012 Cheng D14/447
- D654,921 S * 2/2012 Malsan D14/447
- D657,741 S * 4/2012 Fahrendorff et al. D13/108
- D658,167 S * 4/2012 Buessler et al. D14/251
- D661,309 S * 6/2012 Murrer et al. D14/447
- D668,662 S * 10/2012 Suiter D14/447

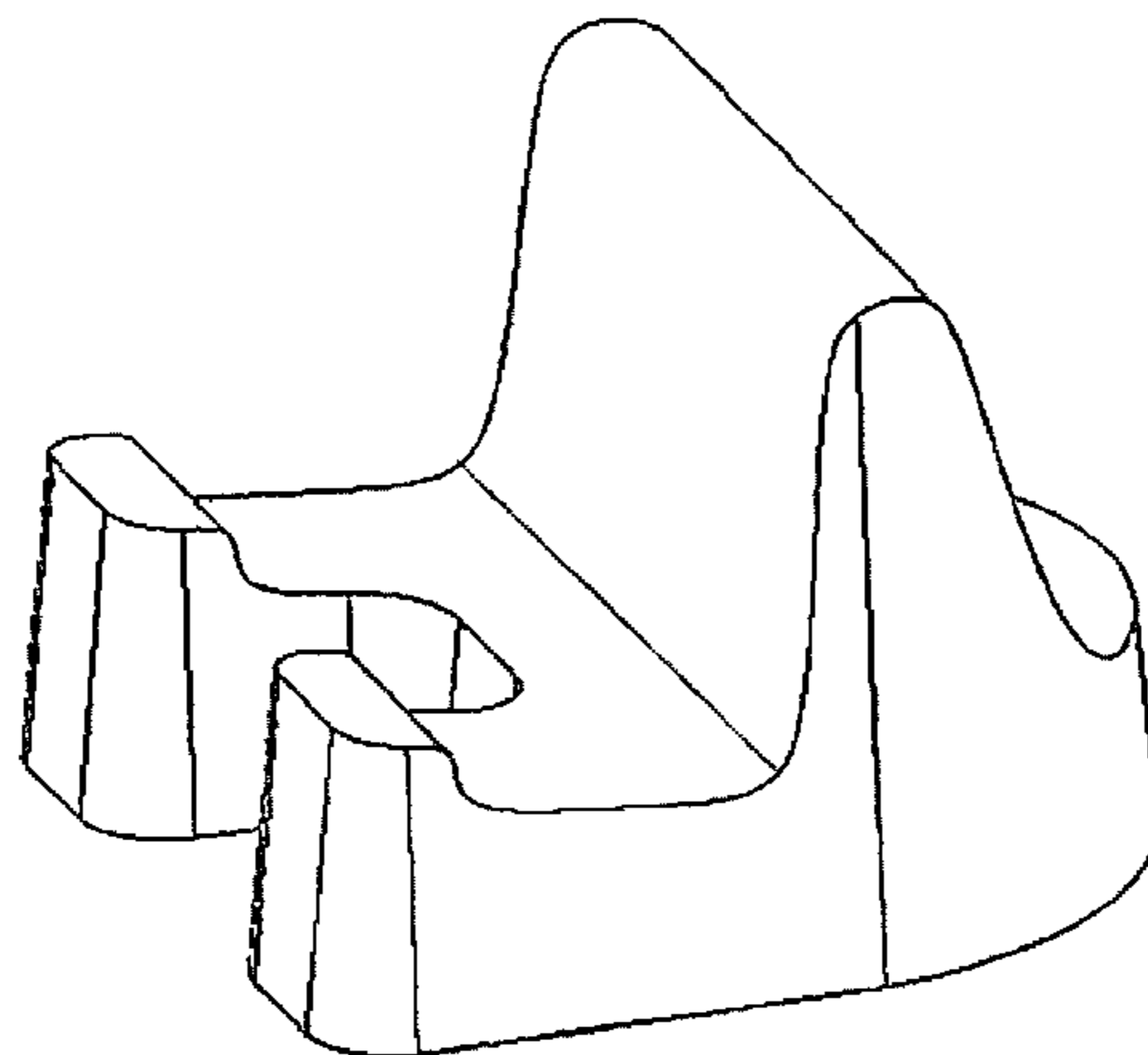

FIG 1

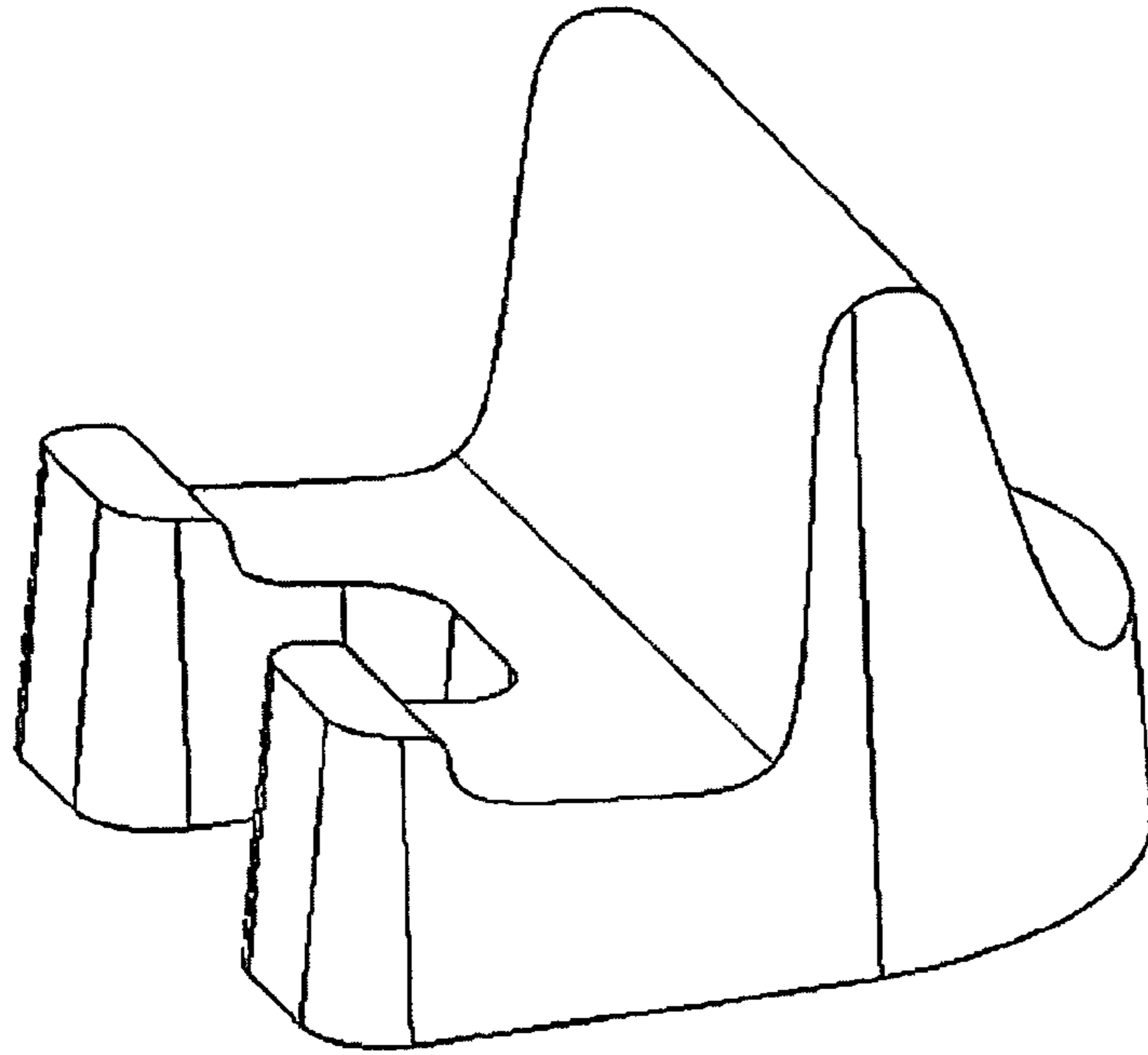

FIG 2

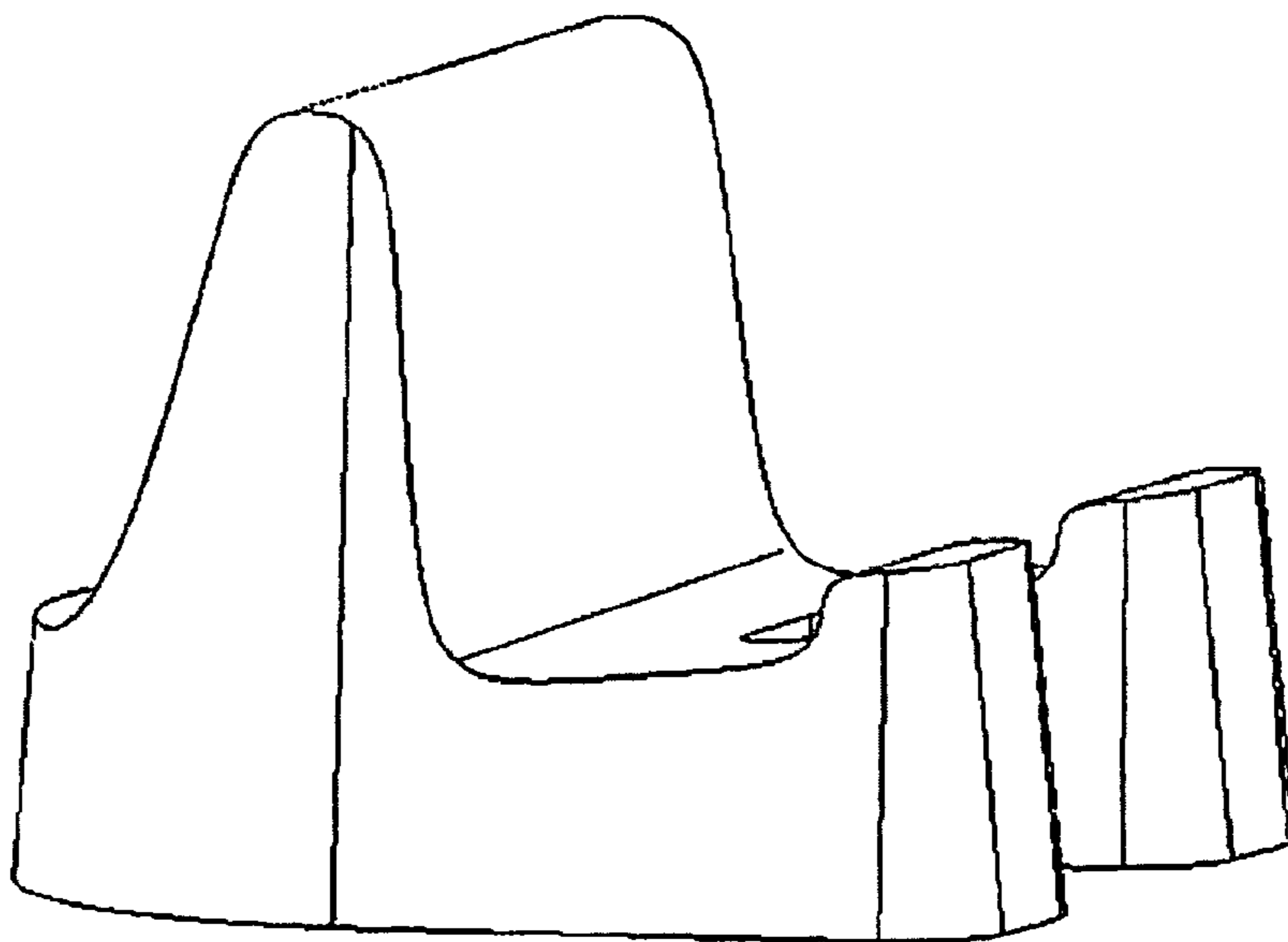

FIG 3

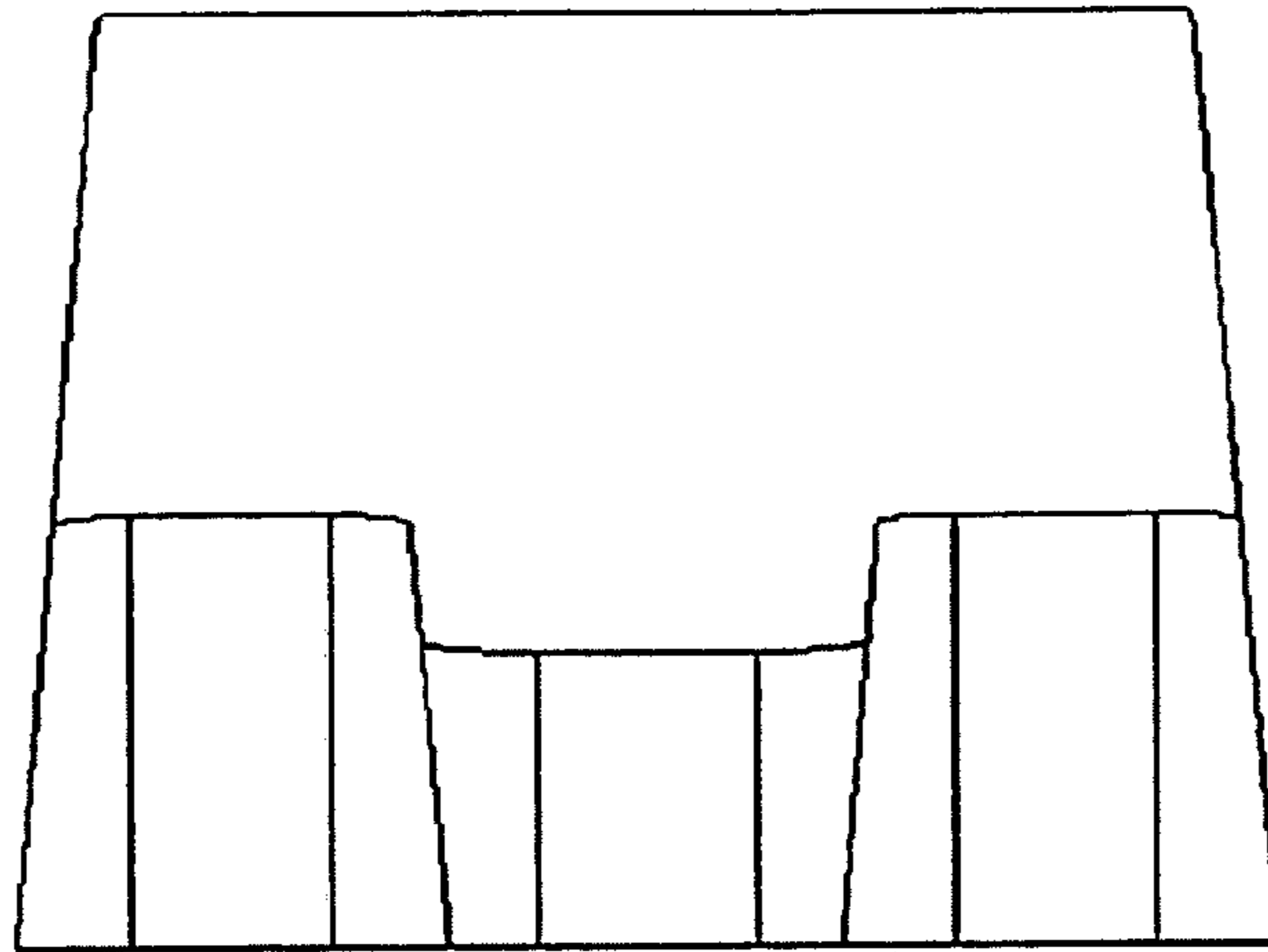

FIG 4

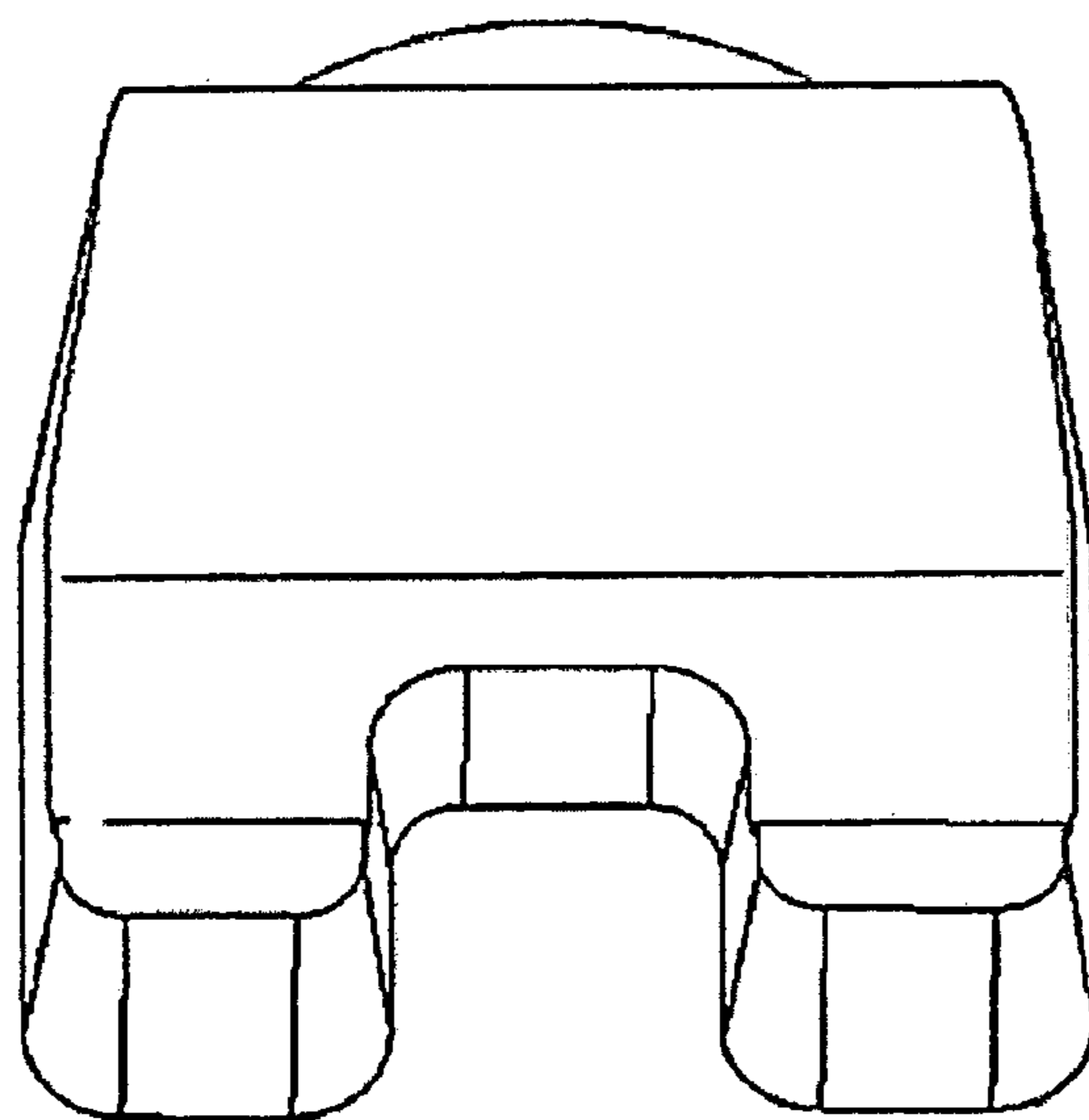

FIG 5

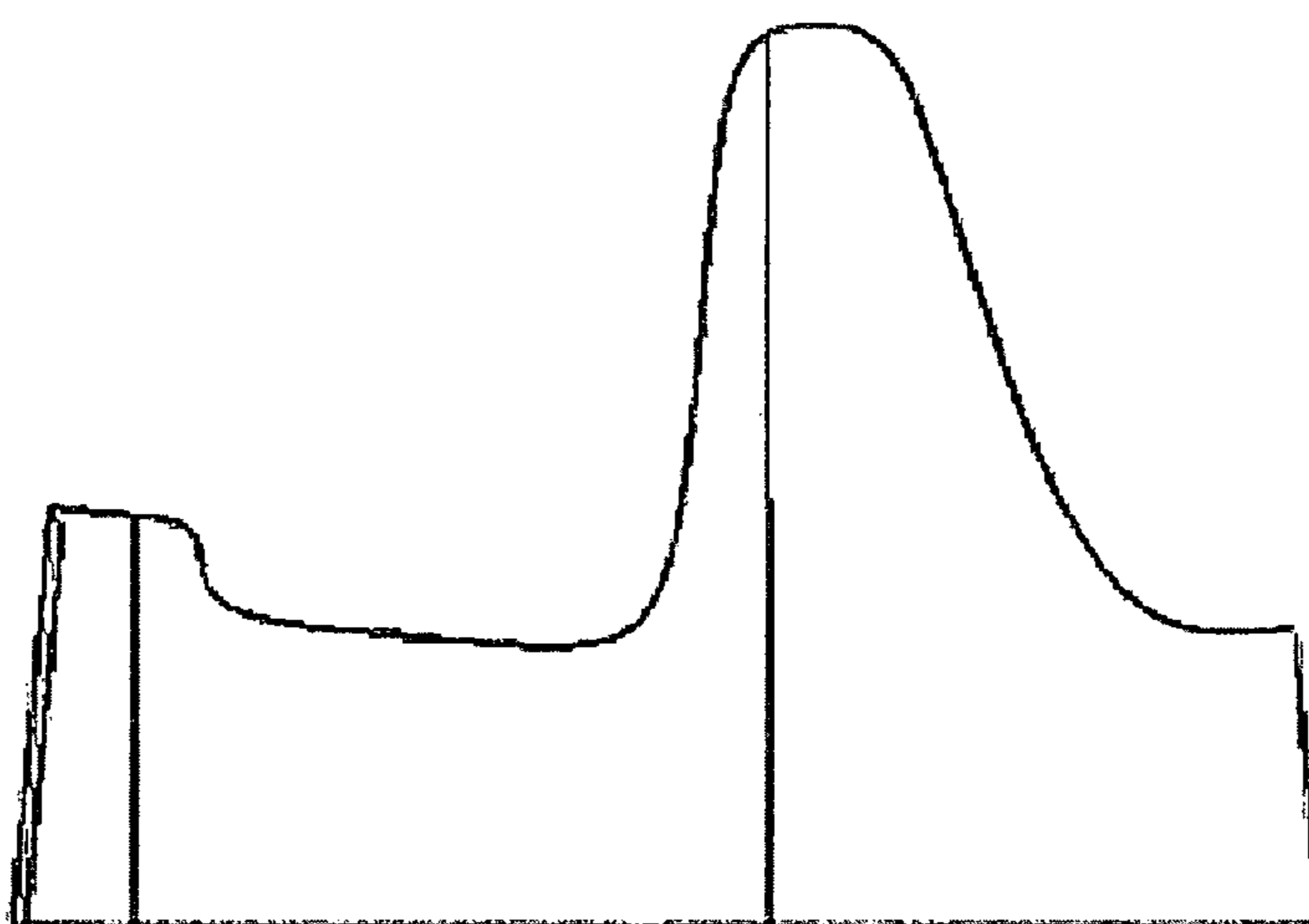

FIG 6

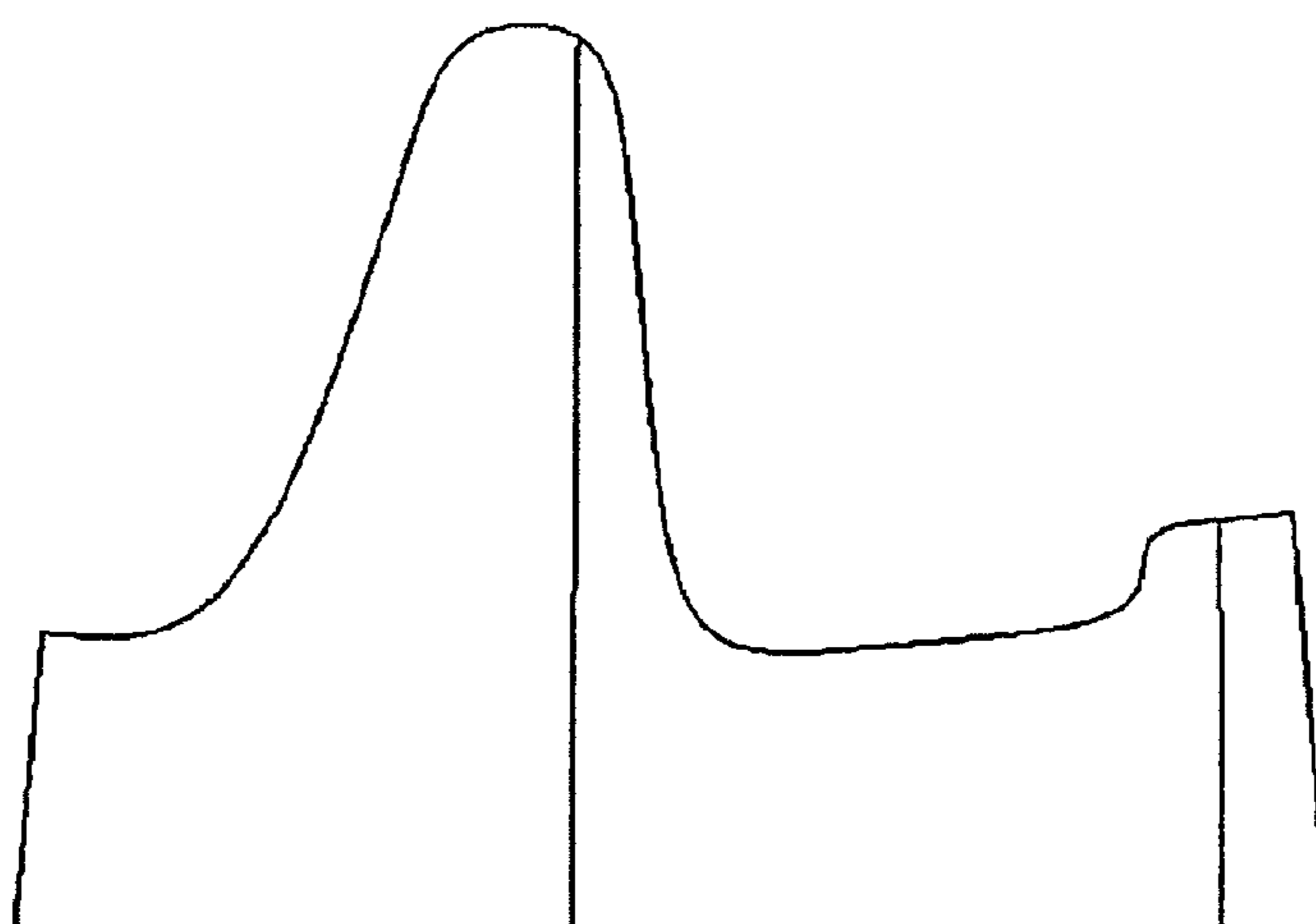

FIG 7

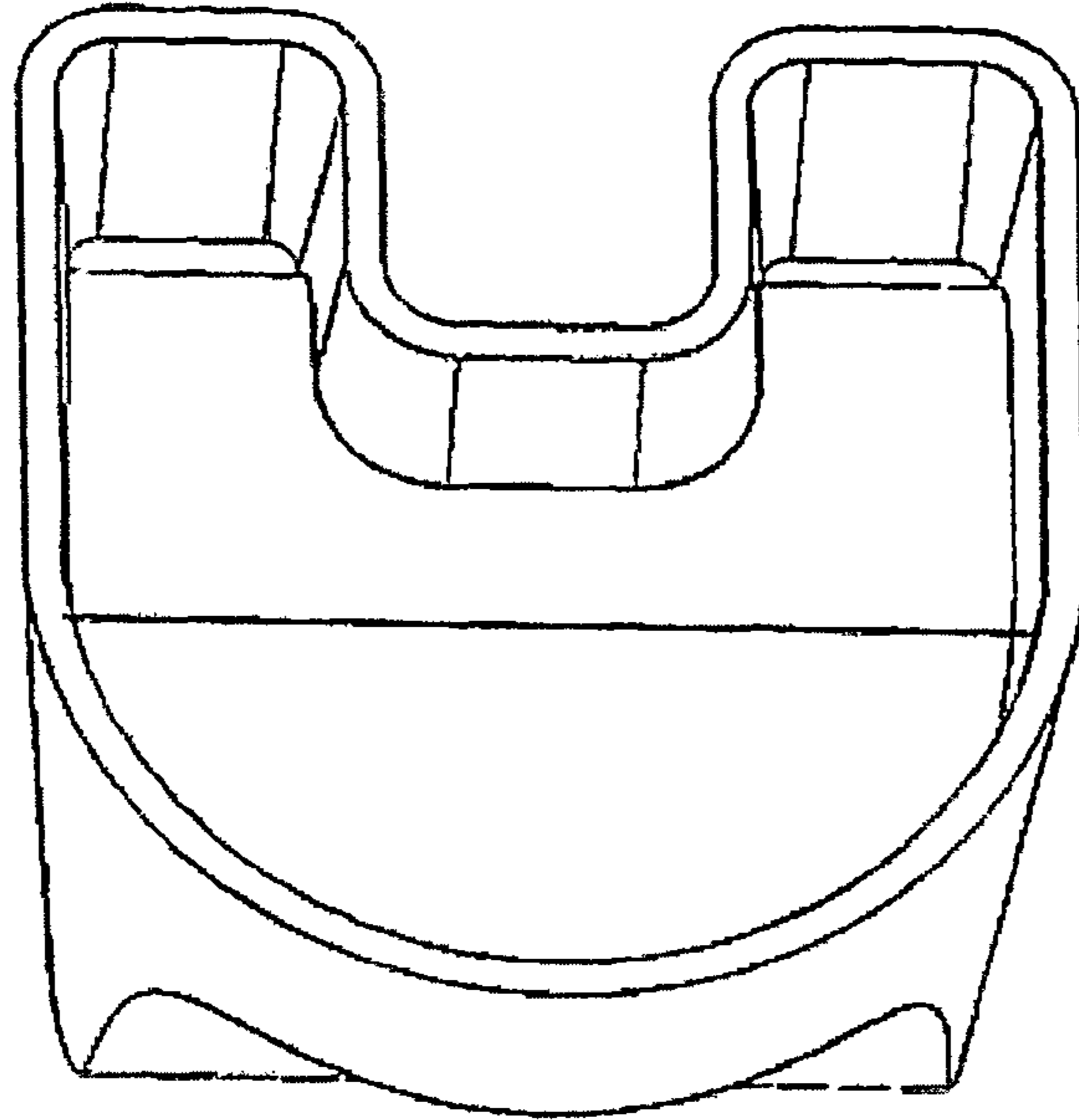

FIG 8

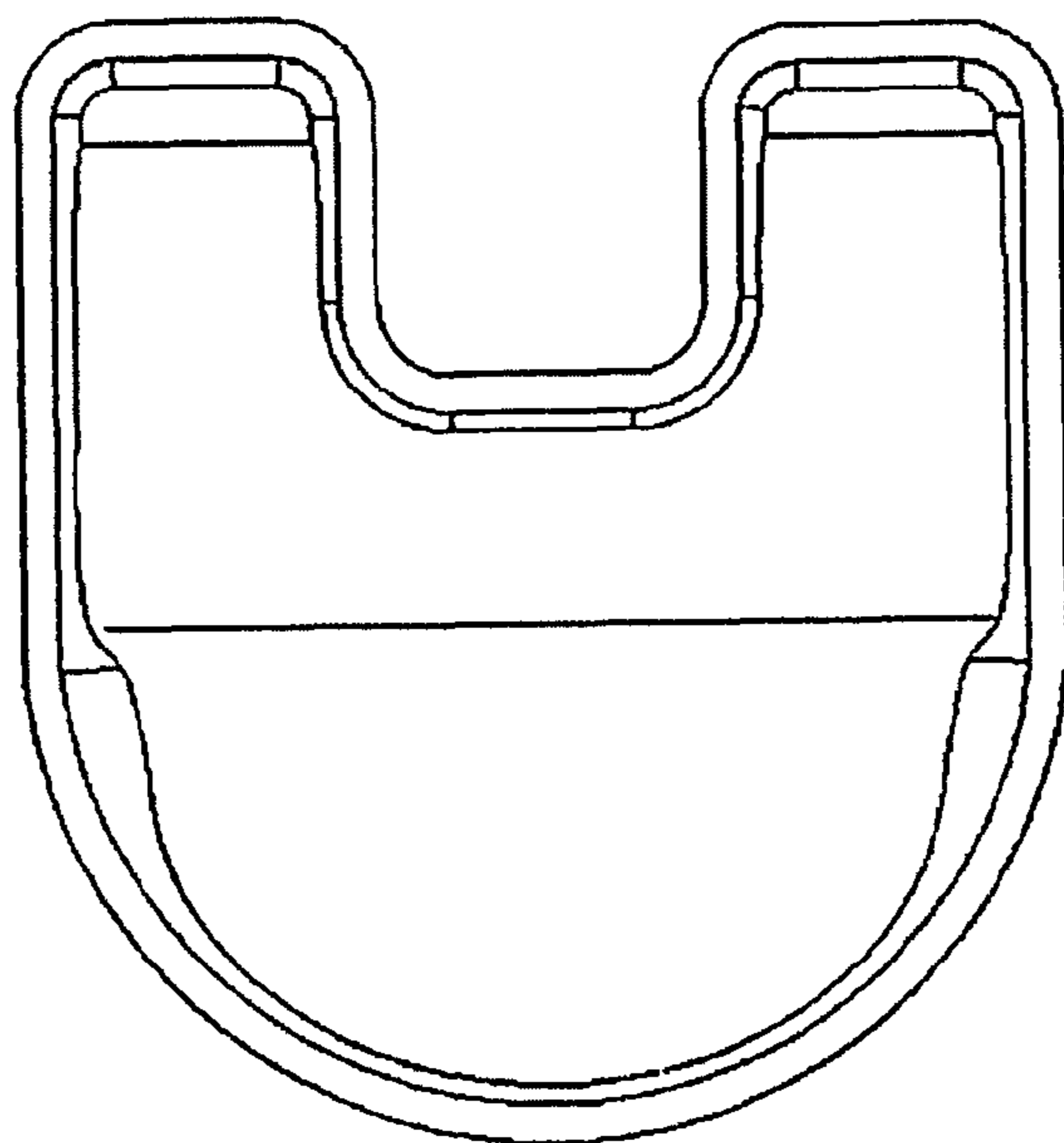

FIG 9

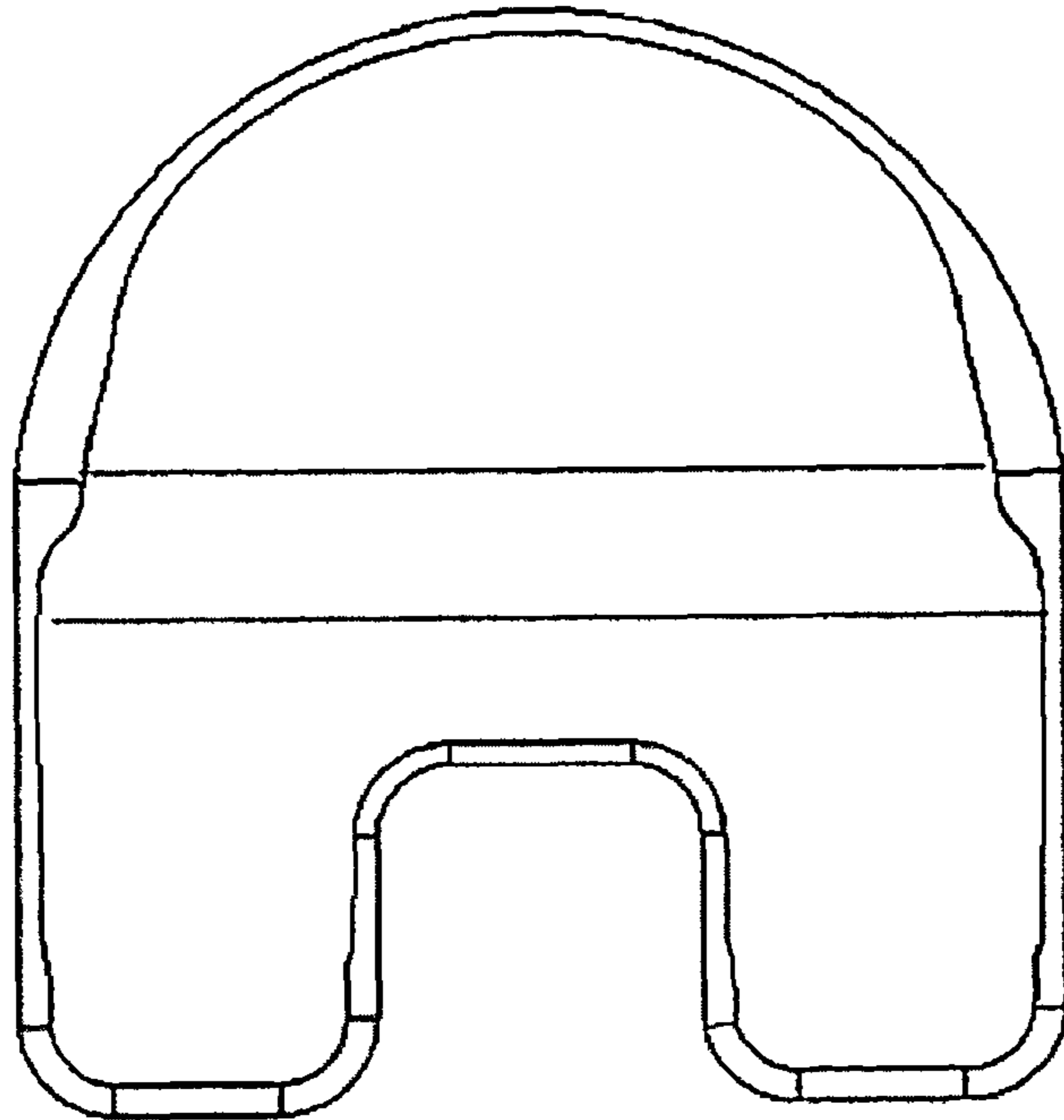

FIG 10

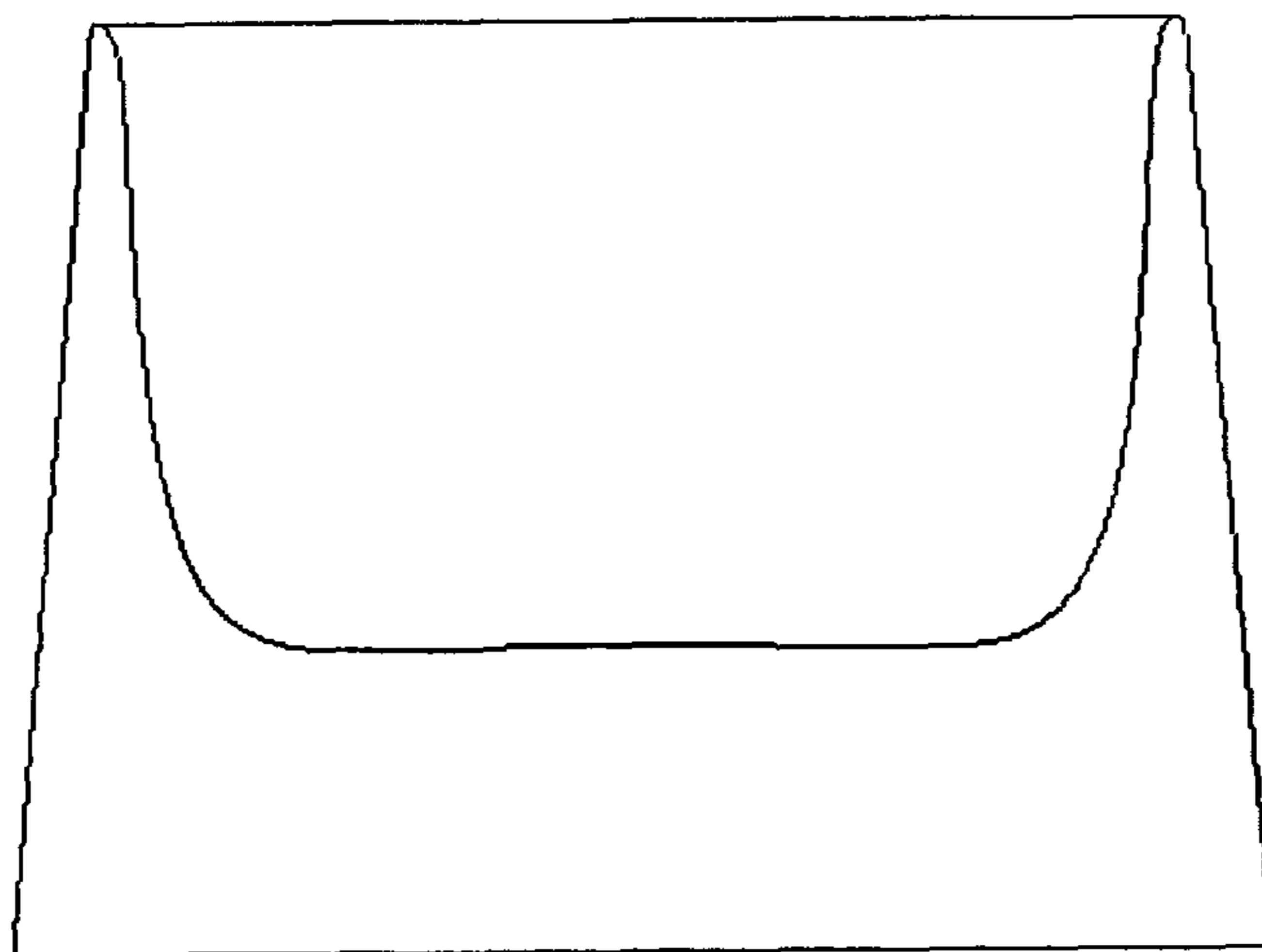

FIG 11

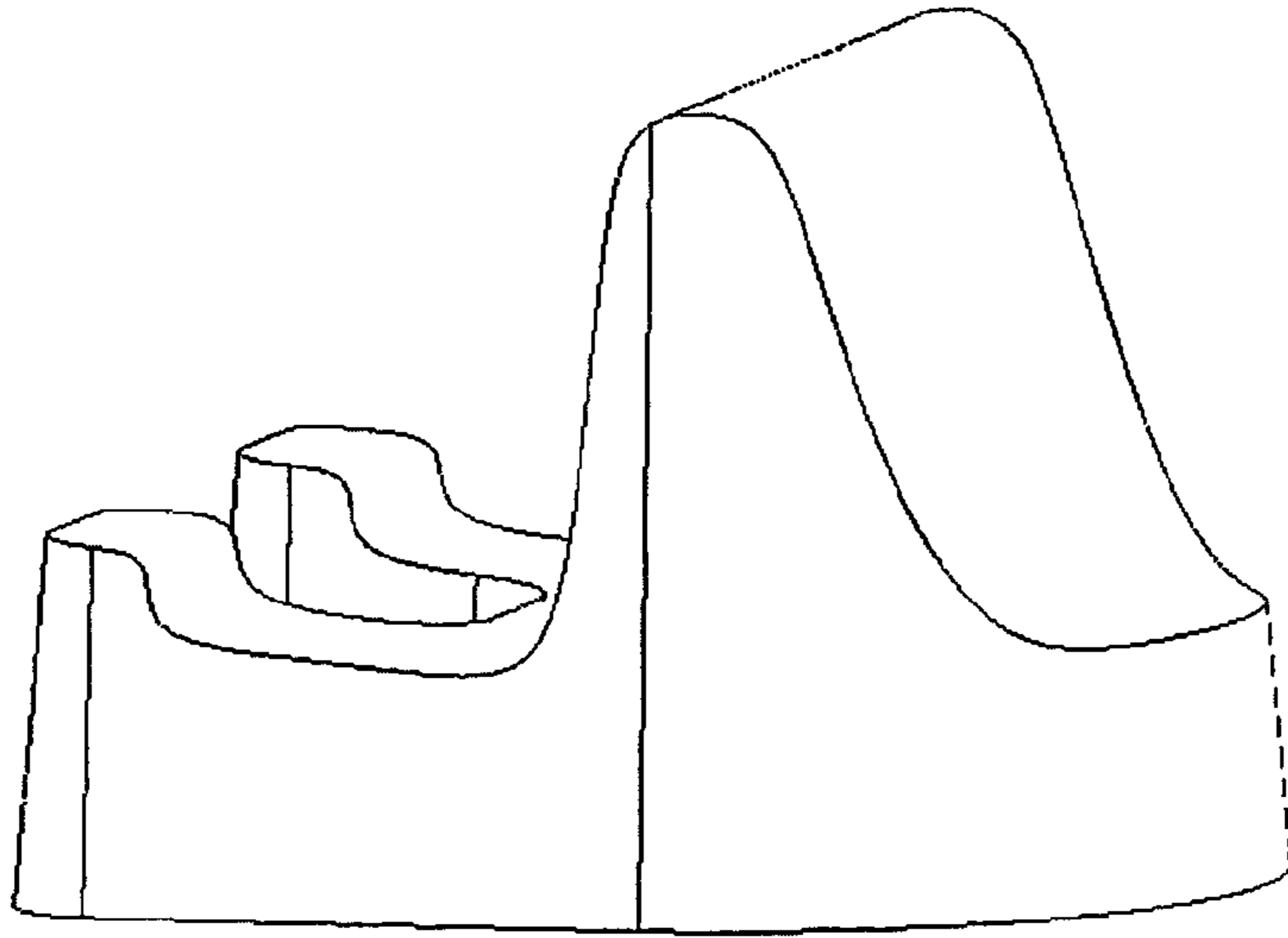

FIG 12

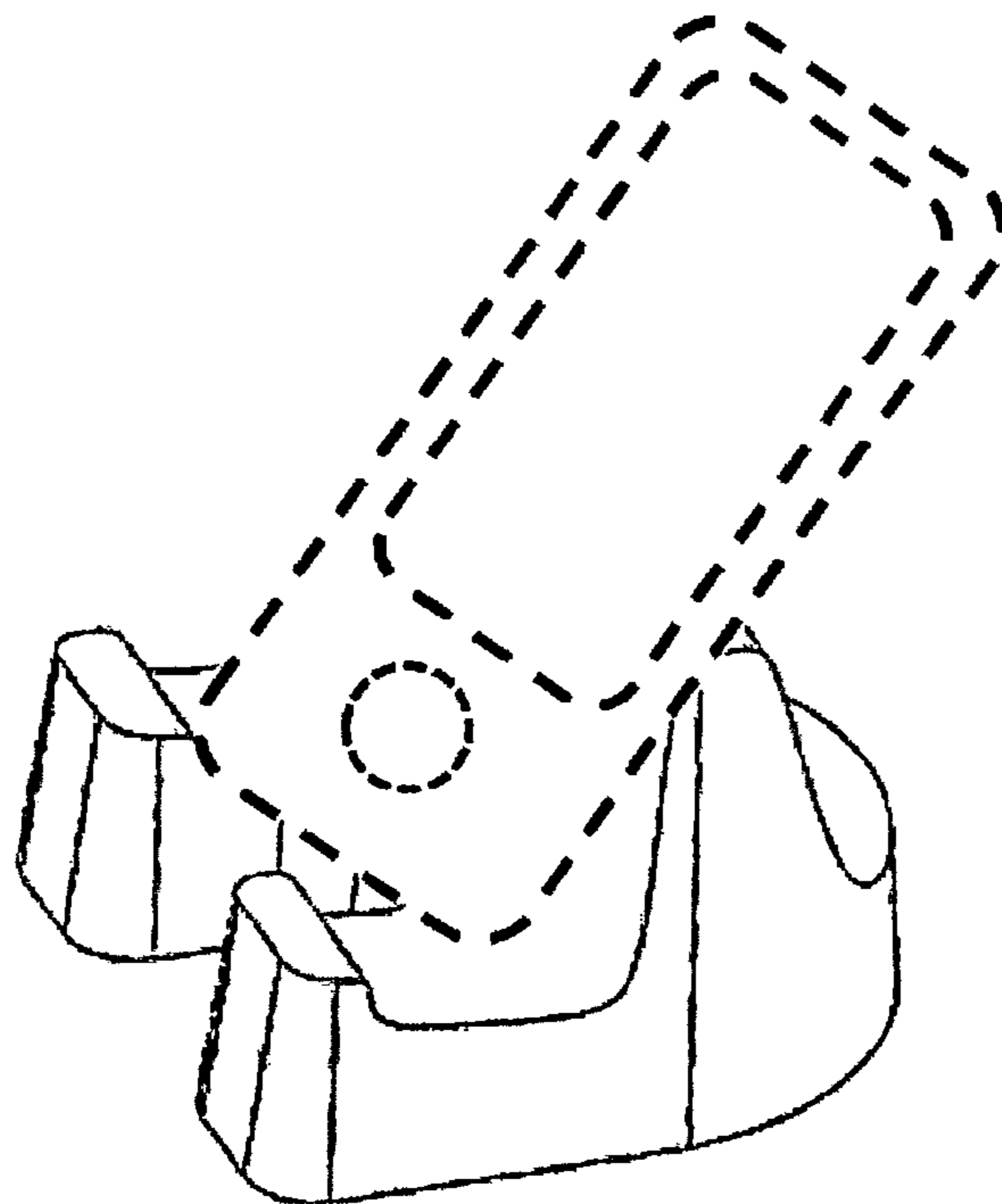

FIG 13

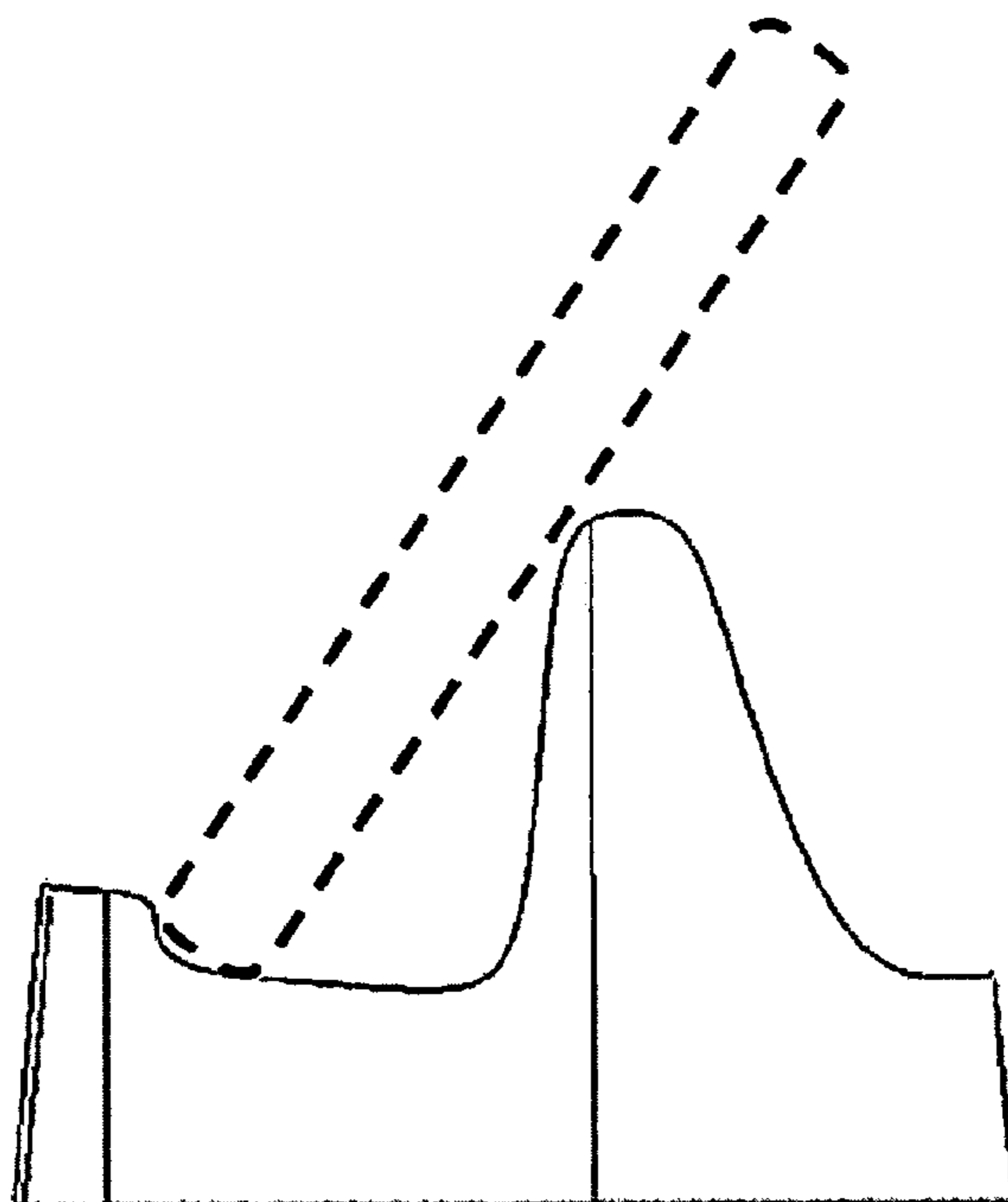

FIG 14

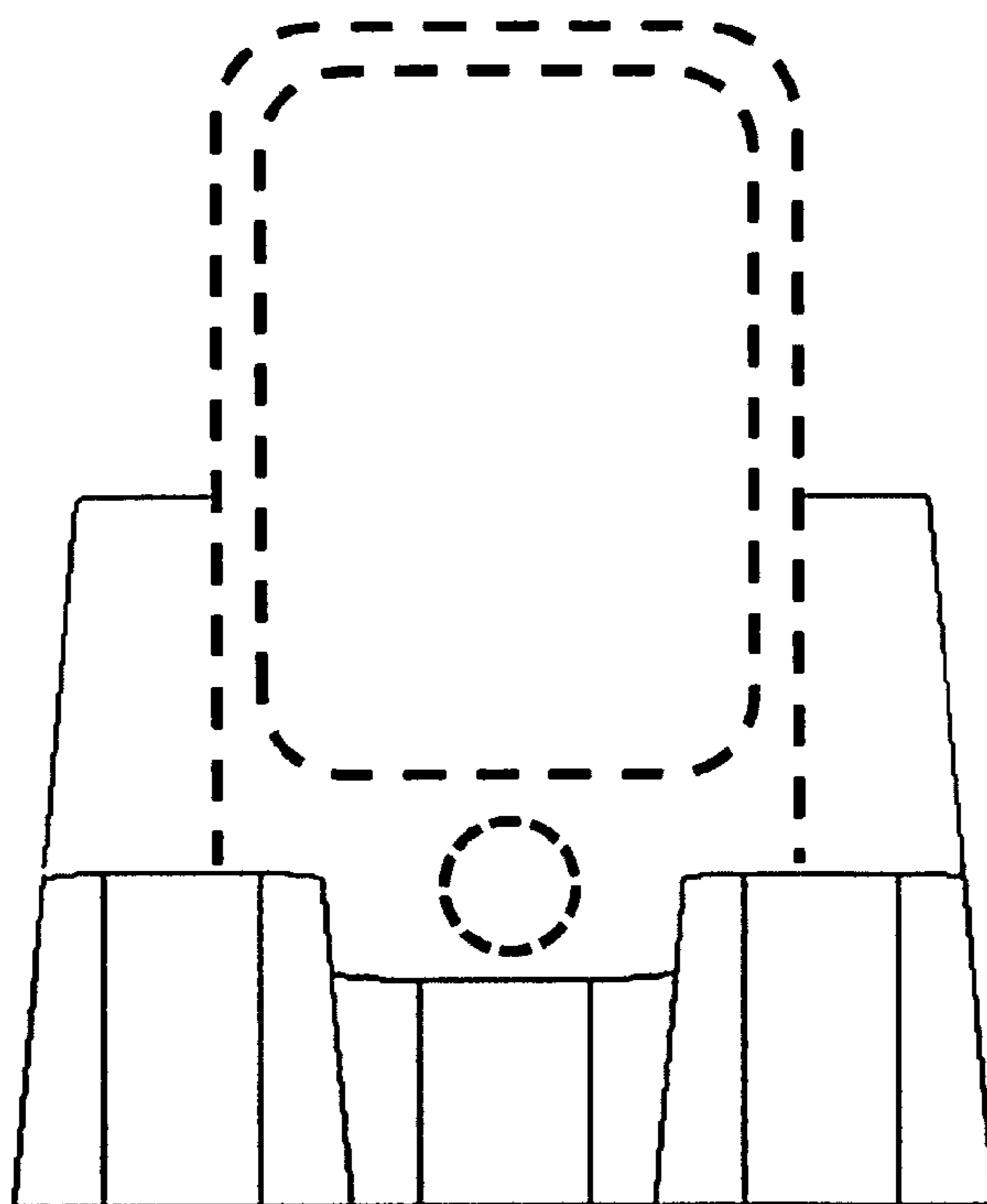

FIG 15

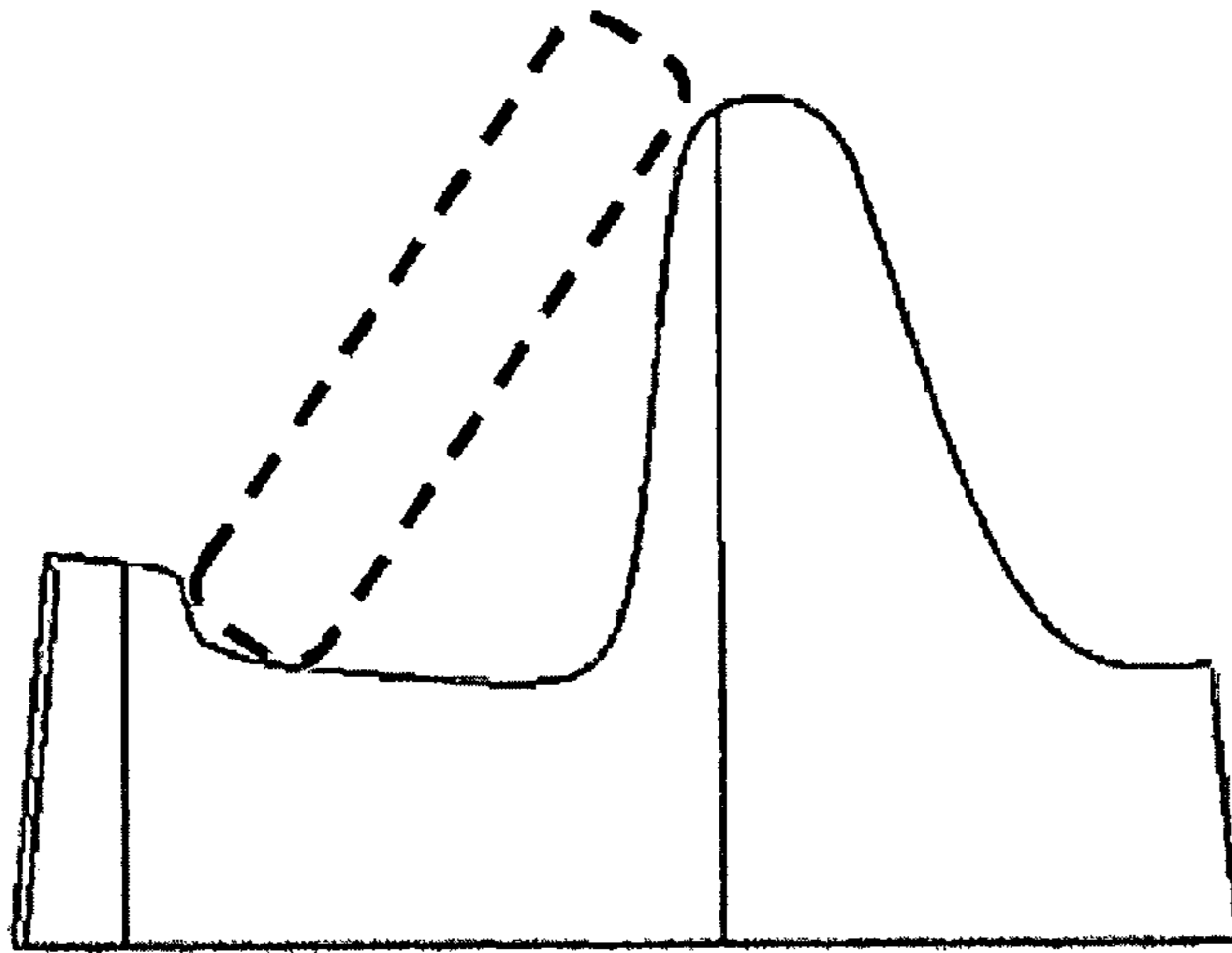

FIG 16

