



US00D730861S

(12) **United States Design Patent**
Ryu et al.

(10) **Patent No.:** **US D730,861 S**
(45) **Date of Patent:** **** *Jun. 2, 2015**

(54) **MOBILE PHONE**

(71) Applicant: **LG Electronics Inc.**, Seoul (KR)

(72) Inventors: **Hyunggon Ryu**, Gyeonggi-do (KR);
Youngho Kim, Seoul (KR); **Minsun Park**, Gyeongsangnam-do (KR)

(73) Assignee: **LG Electronics Inc.**, Seoul (JP)

(*) Notice: This patent is subject to a terminal disclaimer.

(**) Term: **14 Years**

(21) Appl. No.: **29/462,454**

(22) Filed: **Aug. 5, 2013**

(30) **Foreign Application Priority Data**

Feb. 12, 2013 (KR) 30-2013-0007347

(51) **LOC (10) Cl.** **14-03**

(52) **U.S. Cl.**
USPC **D14/138 G**

(58) **Field of Classification Search**
USPC D14/138 R, 138 AD, 138 AC, 138 C,
D14/138 G, 137, 341-347; 455/466, 575.1,
455/575.3, 575.4
CPC H04M 1/0202; H04M 1/0235; H04M
1/0237; H04M 1/0239; H04M 2250/52;
H04M 1/0266; H04M 1/0268; H04M 1/0295;
H04M 2250/22; G06F 1/1626; G06F 1/1624
See application file for complete search history.

(56) **References Cited**

U.S. PATENT DOCUMENTS

D548,713 S * 8/2007 Lee et al. D14/138 AD
D589,924 S * 4/2009 Jung et al. D14/138 AD
D656,477 S * 3/2012 Yi et al. D14/138 G
D661,277 S * 6/2012 Kim D14/138 G

D671,086 S * 11/2012 Yu et al. D14/138 G
D675,585 S * 2/2013 Park et al. D14/138 G
D676,400 S * 2/2013 Kitamura D14/138 G
D687,002 S * 7/2013 Song et al. D14/138 G
D696,220 S * 12/2013 Seo et al. D14/138 G
D696,640 S * 12/2013 Park et al. D14/138 G
D698,326 S * 1/2014 Choi D14/138 G
D698,782 S * 2/2014 Hong D14/341

(Continued)

FOREIGN PATENT DOCUMENTS

KR 30-0636698 3/2012
KR 30-0649966 6/2012

(Continued)

OTHER PUBLICATIONS

Acer Liquid Gallant E350, announced Aug. 2012, [online], [retrieved on Aug. 21, 2012]. Retrieved from Internet ,<URL: <http://www.gsmarena.com>>.*

(Continued)

Primary Examiner — Bridget L Eland

(74) *Attorney, Agent, or Firm* — Morgan, Lewis & Bockius LLP

(57) **CLAIM**

The ornamental design for a mobile phone, as shown and described.

DESCRIPTION

FIG. 1 is a perspective view of a mobile phone showing our new design;
FIG. 2 is a front view thereof;
FIG. 3 is a rear view thereof;
FIG. 4 is a left side view thereof;
FIG. 5 is a right side view thereof;
FIG. 6 is a top plan view thereof;
FIG. 7 is a bottom plan view thereof; and,
FIG. 8 is a rear perspective view thereof.

1 Claim, 7 Drawing Sheets

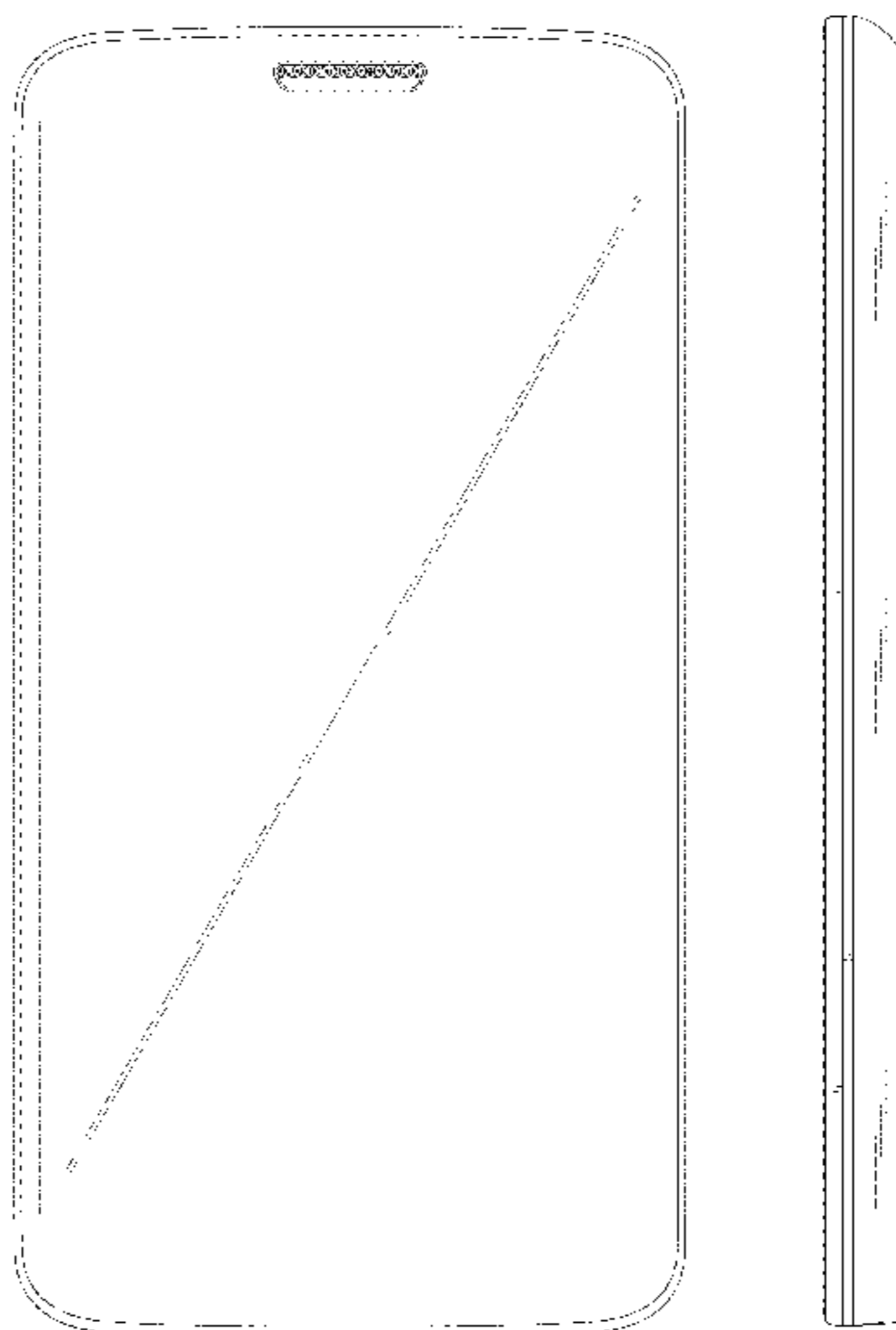

(56)

References Cited

U.S. PATENT DOCUMENTS

D699,206	S *	2/2014	Kim	D14/138	G
D700,163	S *	2/2014	Huang et al.	D14/138	G
D701,191	S *	3/2014	Suk	D14/138	G
D707,647	S *	6/2014	Kim et al.	D14/138	G
D711,339	S *	8/2014	Yang	D14/138	G
D712,861	S *	9/2014	Fujimura et al.	D14/138	G
D720,320	S *	12/2014	Yang	D14/138	G
D720,321	S *	12/2014	Fu et al.	D14/138	G
D721,346	S *	1/2015	Lee et al.	D14/138	G
D721,668	S *	1/2015	Fujimura et al.	D14/138	G
D723,495	S *	3/2015	Jeong	D14/138	G
2007/0218963	A1 *	9/2007	Kim	455/575.4	
2007/0232368	A1 *	10/2007	Feightner et al.	455/575.1	
2011/0143825	A1 *	6/2011	Ahn et al.	455/575.4	

FOREIGN PATENT DOCUMENTS

KR	30-0649967	6/2012
KR	30-0649974-1	9/2012
KR	30-0649974-2	9/2012
KR	30-0649965	1/2013
KR	30-0649974	1/2013
KR	30-0649975	1/2013
KR	30-0649985	1/2013

OTHER PUBLICATIONS

Huawei Ascend D quad, announced Feb. 2012, [online], [retrieved on Mar. 15, 2012]. Retrieved from Internet ,<URL: <http://www.gsmarena.com>>.*
 Acer Liquid C1, announced Jan. 2013, [online], [retrieved on Mar. 4, 2013]. Retrieved from Internet ,<URL: <http://www.gsmarena.com>>.*
 Philips W635, announced Apr. 2012, [online], [retrieved on May 11, 2012]. Retrieved from Internet ,<URL: <http://www.gsmarena.com>>.*
 Motorola Moto XT882 (Publication date: May, 2011)—http://www.gsmarena.com/motorola_moto_xt882-3981.php.

Motorola ATRIX (Publication date: Jan. 2011)—http://www.gsmarena.com/motorola_atrix-3709.php.
 HTC Amaze 4G (Publication date: Oct. 2011)—http://www.gsmarena.com/htc_amaze_4g-4097.php.
 Dell Streak Pro D43 (Publication date: Dec. 2011)—http://www.gsmarena.com/dell_streak_pro_d43-4384.php.
 Dell Mini 3i (Publication date: Nov. 2009)—http://www.gsmarena.com/dell_mini_3i-3033.php.
 Pantech Sirius IM-A600S (Publication date: Apr. 2010)—<http://review.citizen.com/SIRIUS/view/3/4764/review>.
 KT Tech EV-F500 (Publication date: Sep. 2010)—<http://review.citizen.com/MonggeulMonggeul/view/1/4832/review>.
 Blu—Studio 5.3 (Publication date: Dec. 16, 2011)—<http://www.priceindia.org/mobile/blu/blu-studio-5-3-price/>.
 Huawei U8220 (Publication date: Aug. 2009)—http://www.gsmarena.com/huawei_u8220-3144.php.
 Optimus LTE (Publication date: Oct. 10, 2011)—<http://blog.naver.com/jms8641?Redirect=Log&logNo=40143258245>.
 European Community Design 001335152-0001, electronic devices, Aug. 6, 2012, pp. 1-2.
 European Community Design 001335152-0002, electronic devices, Aug. 6, 2012, pp. 1-2.
 European Community Design 001332654-0003, electronic devices, Jul. 9, 2012, pp. 1-2.
 European Community Design 001332654-0004, electronic devices, Jul. 9, 2012, pp. 1-2.
 European Community Design 001332654-0006, electronic devices, Jul. 9, 2012, pp. 1-2.
 European Community Design 001332654-0005, electronic devices, Jul. 9, 2012, pp. 1-2.
 European Community Design 001332654-0002, electronic devices, Jul. 9, 2012, pp. 1-2.
 European Community Design 001332654-0001, electronic devices, Jul. 9, 2012, pp. 1-2.
 European Community Design 001271167-0001, electronic devices, May 20, 2011, pp. 1-2.

* cited by examiner

FIG. 1

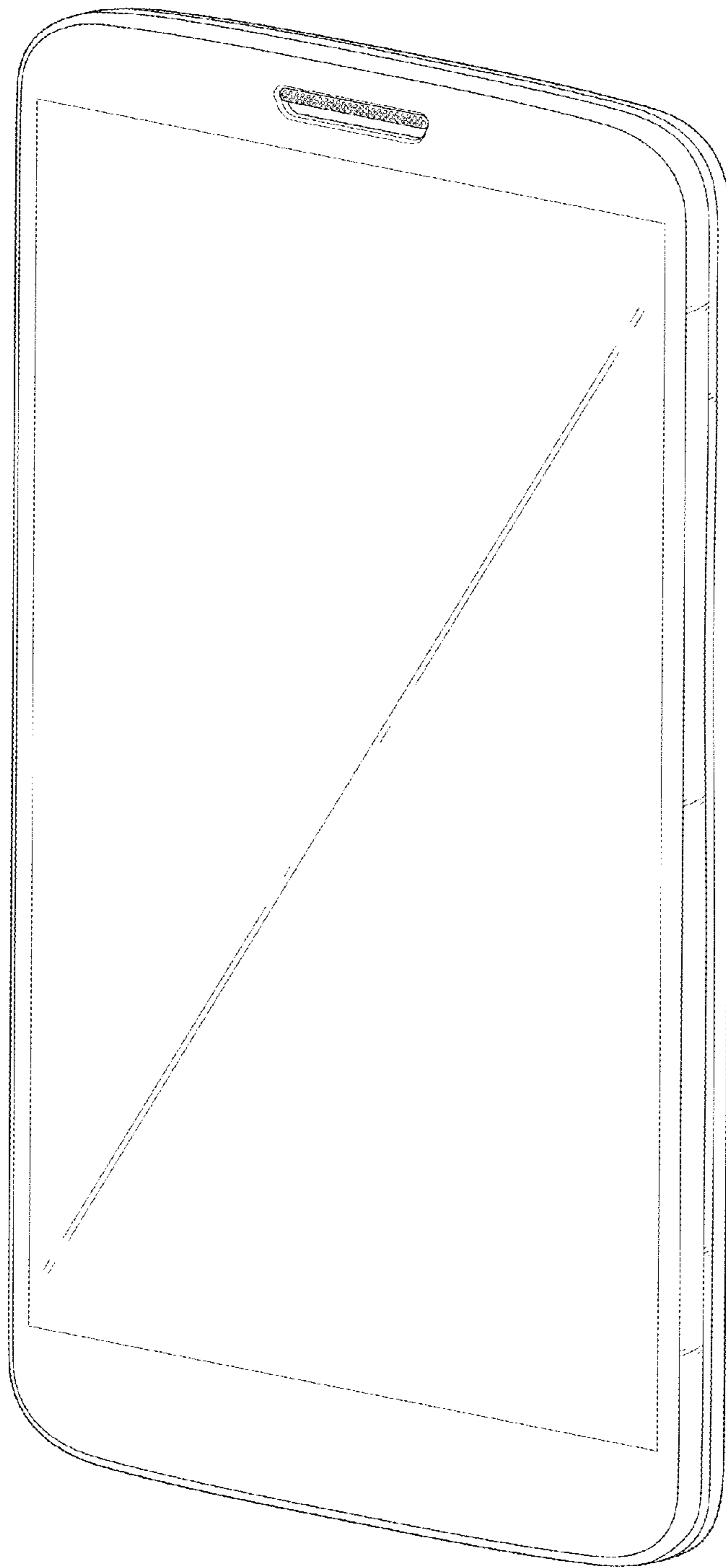

FIG. 2

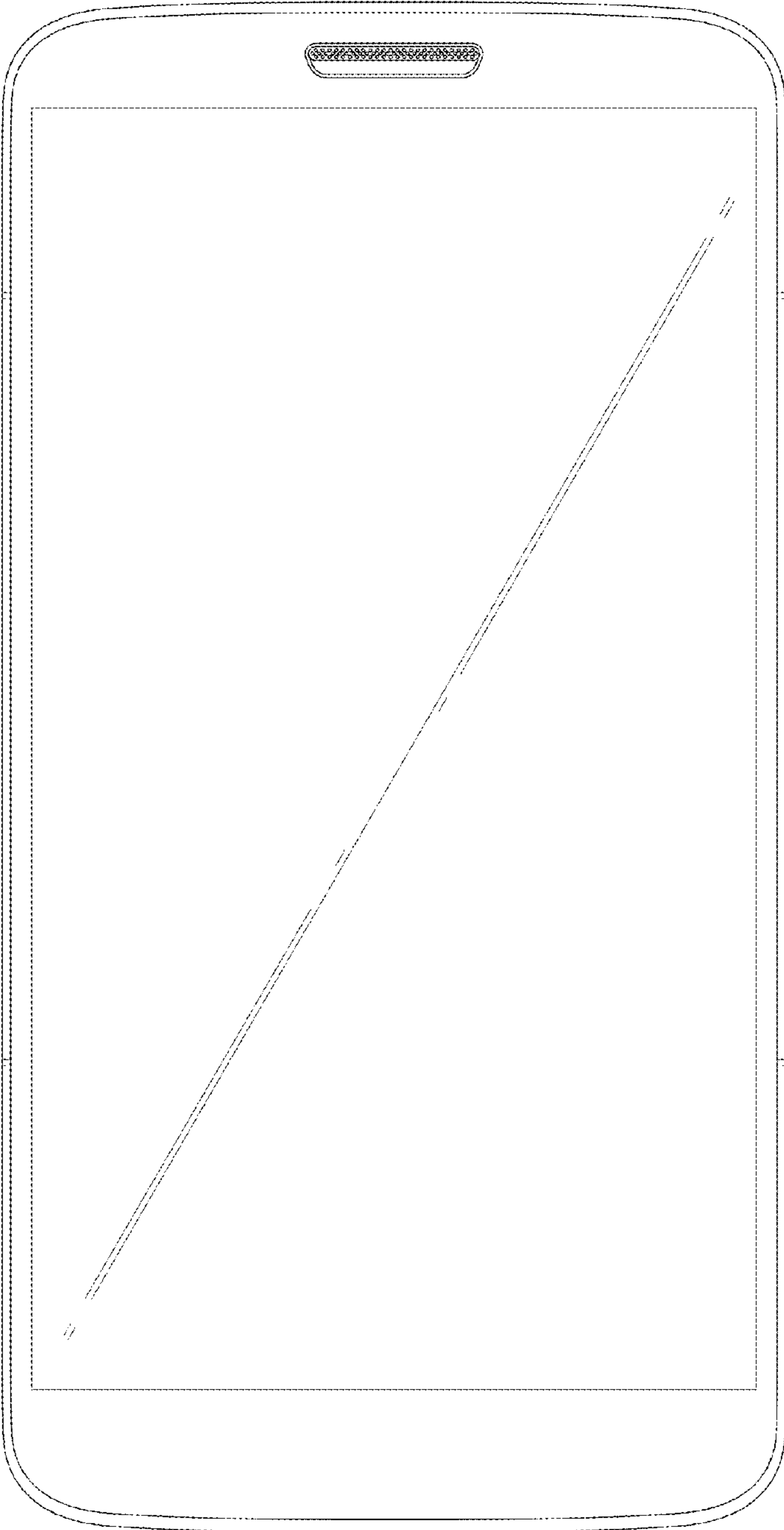

FIG. 3

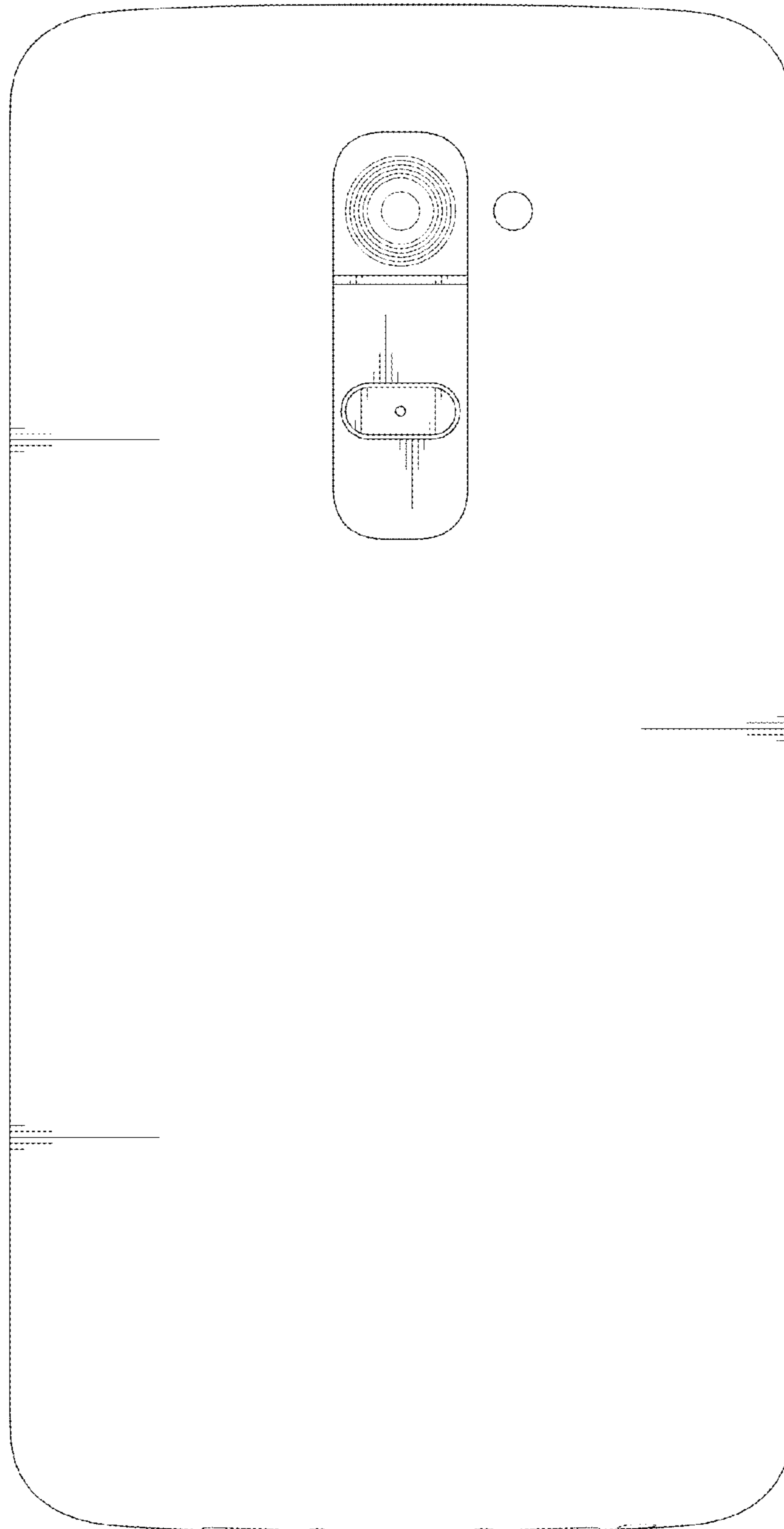

FIG. 4

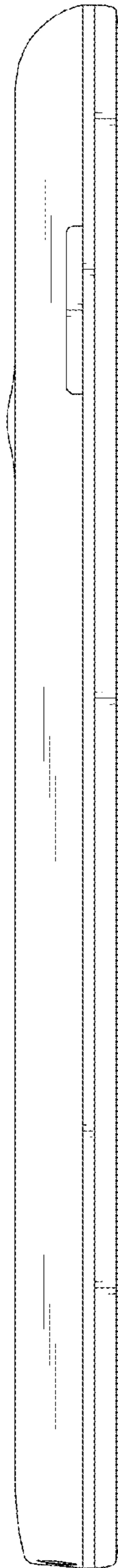

FIG. 5

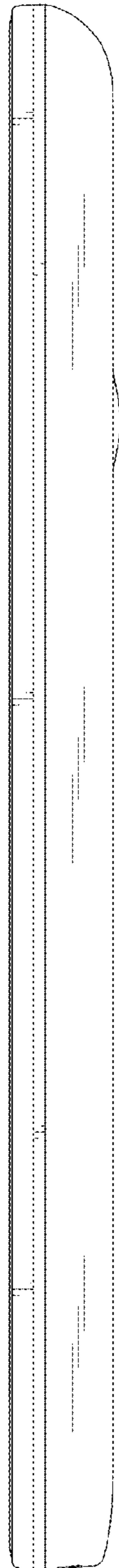

FIG. 6

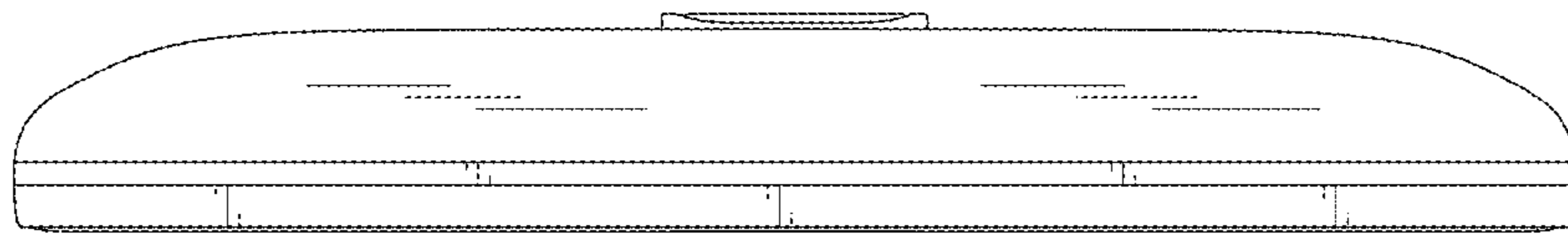

FIG. 7

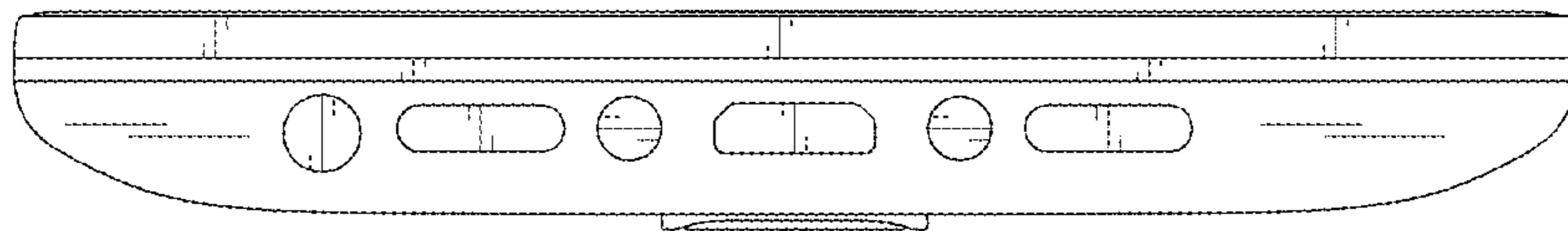

FIG. 8

