



US00D730697S

(12) **United States Design Patent**  
**Johnson et al.**

(10) **Patent No.:** **US D730,697 S**  
(45) **Date of Patent:** **\*\* Jun. 2, 2015**

- (54) **CONTAINER WITH HANDLES**
- (71) Applicant: **Munchkin, Inc.**, Van Nuys, CA (US)
- (72) Inventors: **Kevin Douglas Johnson**, Tarzana, CA (US); **Matthew Joseph Saxton**, Agoura, CA (US); **Heesung Jang**, Lexington, KY (US)
- (73) Assignee: **Munchkin, Inc.**, Van Nuys, CA (US)
- (\*\*) Term: **14 Years**
- (21) Appl. No.: **29/471,226**
- (22) Filed: **Oct. 29, 2013**
- (51) **LOC (10) Cl.** ..... **07-01**
- (52) **U.S. Cl.**  
USPC ..... **D7/534; D7/510; D7/511; D7/533**
- (58) **Field of Classification Search**  
USPC ..... D7/509–516, 523, 533, 534, 535, 326, D7/543, 548, 300, 312, 314, 316, 318, 319, D7/320, 598, 589, 396.2, 507; 215/229; D24/197, 198, 199; 220/703, 714, 710, 220/710.5, 212.5  
CPC ..... A47G 19/22; A47G 19/2266; A47G 19/2272; A61J 9/00; A61J 9/06; A61J 9/08; A61J 9/085  
See application file for complete search history.

(56) **References Cited**

**U.S. PATENT DOCUMENTS**

D329,355	S	9/1992	Yagi	
5,273,172	A *	12/1993	Rossbach et al.	215/229
D366,987	S	2/1996	Allegre	
D368,529	S	4/1996	Allegre	
5,518,142	A *	5/1996	Lin	220/707
D375,655	S	11/1996	King	
D421,878	S *	3/2000	Roehrig	D7/510
6,050,433	A *	4/2000	Russell et al.	215/229
D425,994	S *	5/2000	Hakim	D24/197

D442,435	S *	5/2001	Takagi	D7/510
D448,971	S *	10/2001	Hughes	D7/392.1
D454,642	S	3/2002	Hakim	
D476,849	S	7/2003	Randolph	
D513,932	S	1/2006	De Oliveira	
D609,528	S *	2/2010	Roehrig et al.	D7/510
D616,706	S	6/2010	Bofinger et al.	
D625,424	S *	10/2010	MacKay et al.	D24/197
D642,866	S *	8/2011	Schofield et al.	D7/510
D644,067	S	8/2011	Valderrama	
D652,248	S	1/2012	Valderrama	
D663,165	S *	7/2012	Manska et al.	D7/523
D674,101	S *	1/2013	Smith	D24/197
8,376,165	B2 *	2/2013	Chiang	215/388
D683,185	S *	5/2013	Thomas	D7/510
D683,188	S *	5/2013	Gold et al.	D7/510
D683,189	S *	5/2013	Thomas	D7/511
D713,687	S *	9/2014	Lv	D7/510

(Continued)

*Primary Examiner* — Marianne Pandozzi

*Assistant Examiner* — Jae Liang

(74) *Attorney, Agent, or Firm* — Wade C. Yamazaki; Robert Z. Evora, Esq.

(57) **CLAIM**

The ornamental design for a container with handles, as shown and described.

**DESCRIPTION**

FIG. 1 is an upper front perspective view of a container with handles showing our new design;  
 FIG. 2 is a lower front perspective view thereof;  
 FIG. 3 is a front view thereof;  
 FIG. 4 is a back view thereof;  
 FIG. 5 is a right side view thereof;  
 FIG. 6 is a left side view thereof;  
 FIG. 7 is a top view thereof; and,  
 FIG. 8 is a bottom view thereof.  
 The broken line showing in the figure drawings are included for the purpose of illustration and form no part of the claimed design.

**1 Claim, 7 Drawing Sheets**

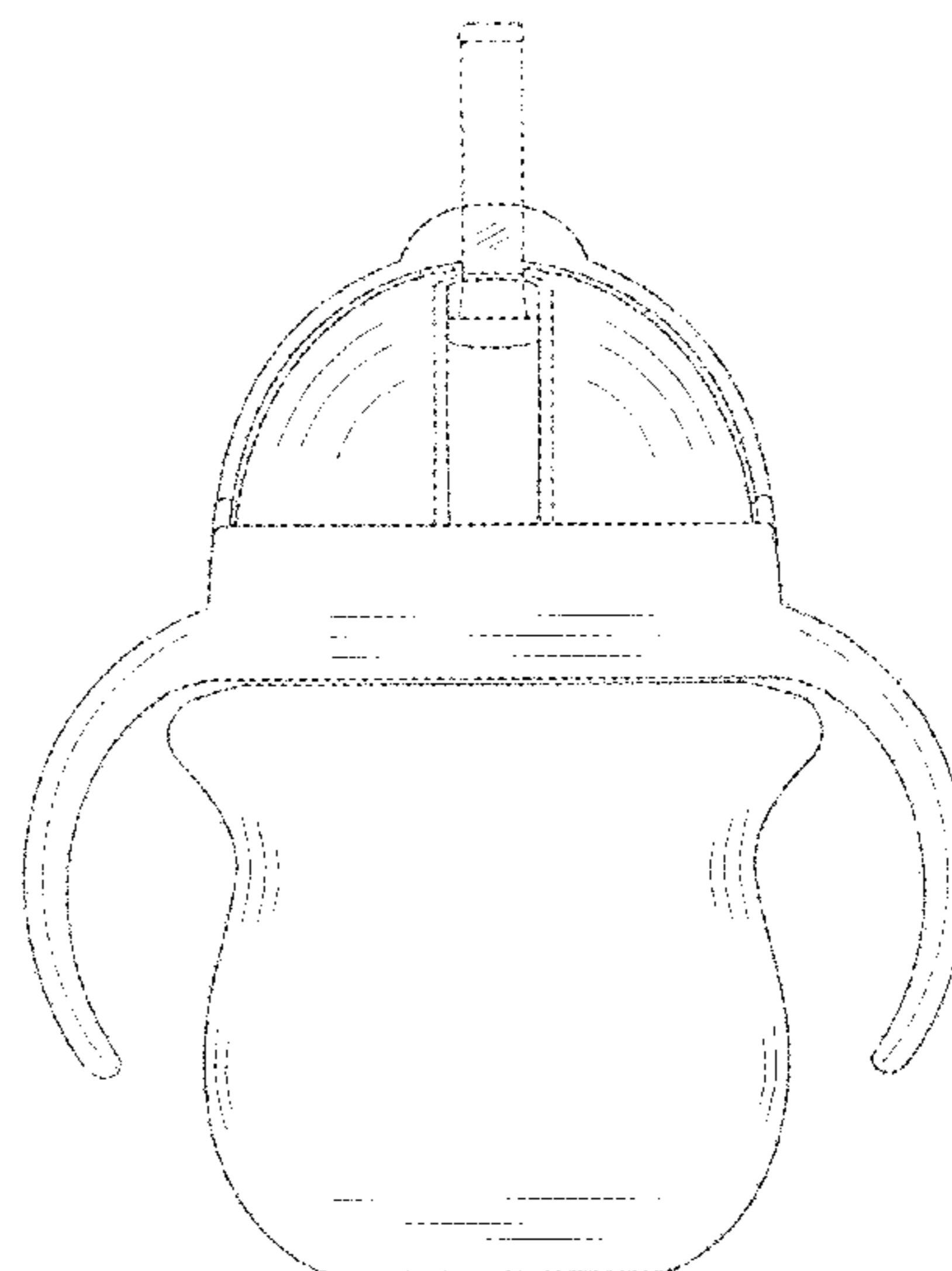
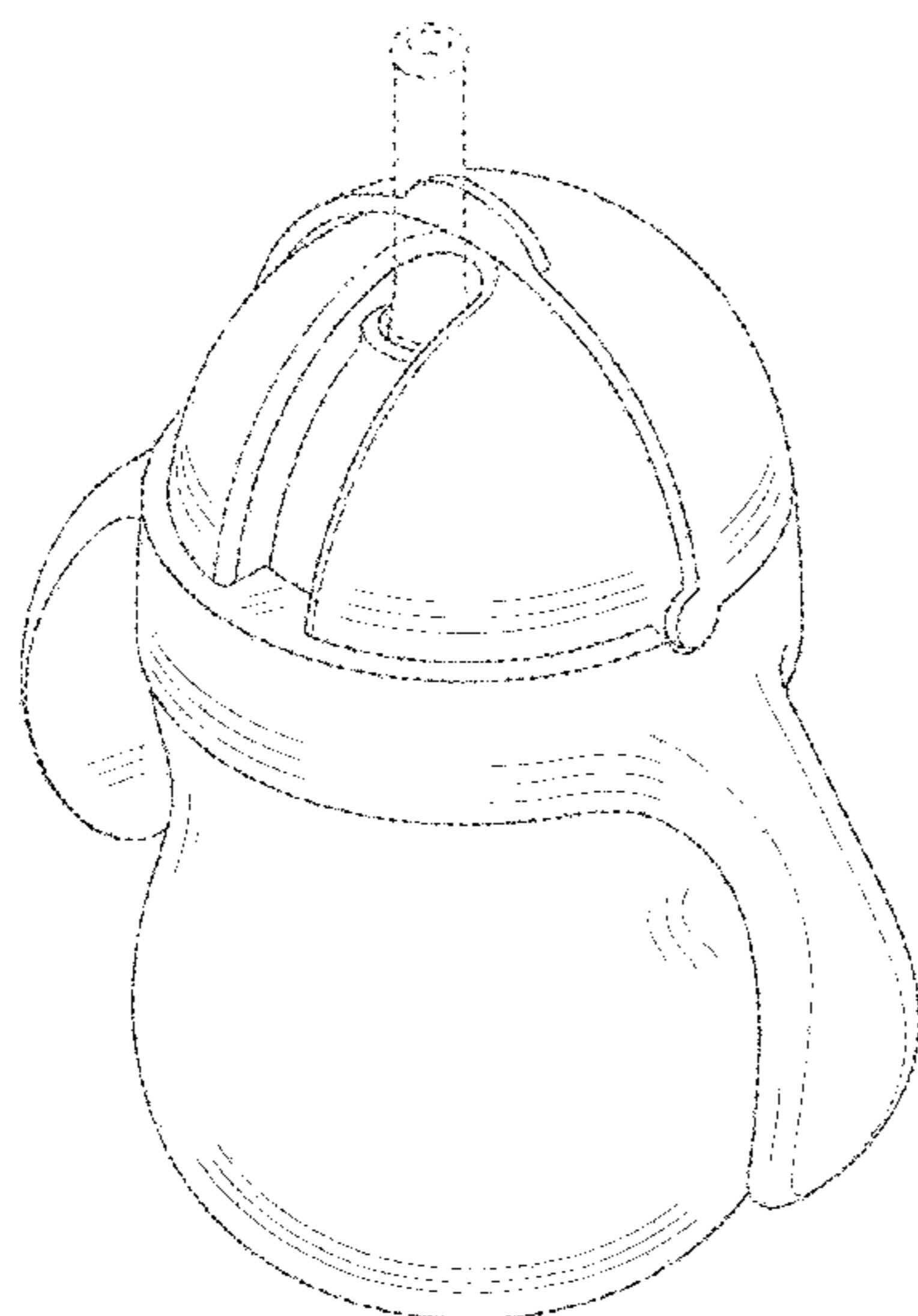

# US D730,697 S

Page 2

---

(56)

## References Cited

### U.S. PATENT DOCUMENTS

D717,116 S \* 11/2014 Aslan ..... D7/523  
D717,117 S \* 11/2014 Saxton et al. .... D7/534  
D718,090 S \* 11/2014 Roehrig ..... D7/510

D725,434 S \* 3/2015 De Leo ..... D7/392.1  
2009/0255944 A1 \* 10/2009 Yamashita et al. .... 220/705  
2011/0284538 A1 \* 11/2011 Valderrama et al. .... 220/212.5  
2014/0158699 A1 \* 6/2014 Kim et al. .... 220/592.17

\* cited by examiner

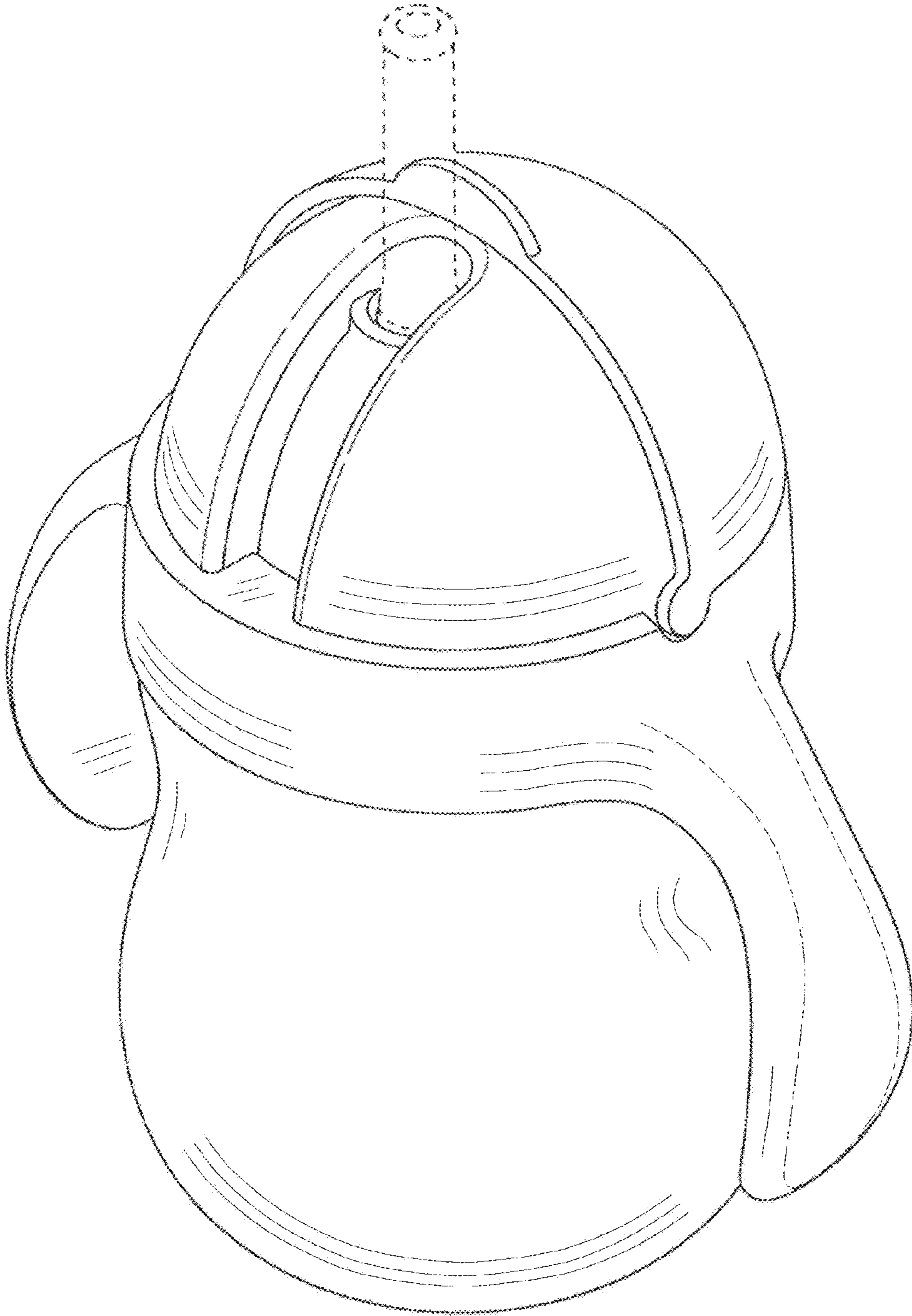

FIG. 1



FIG. 2

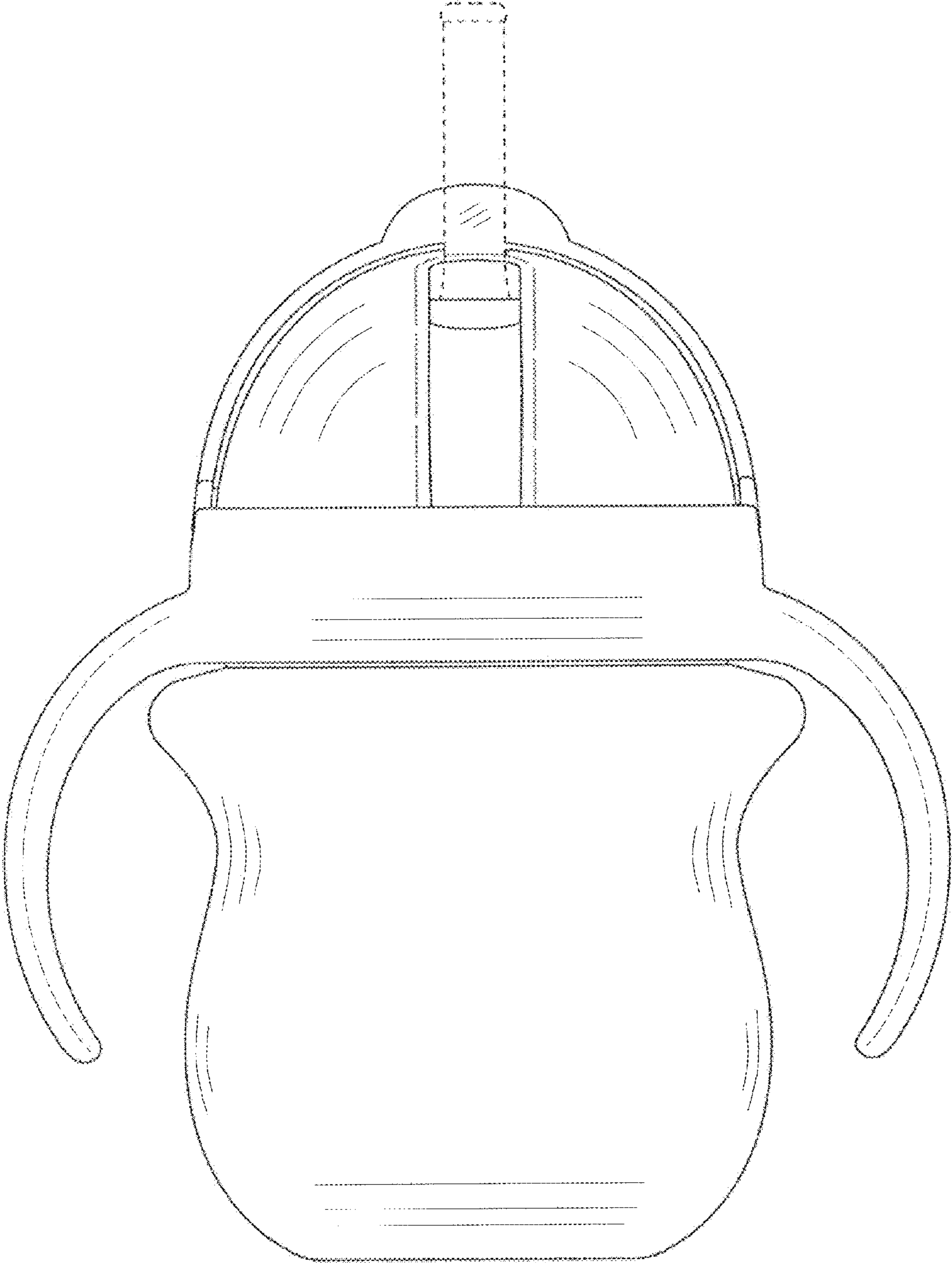

FIG. 3

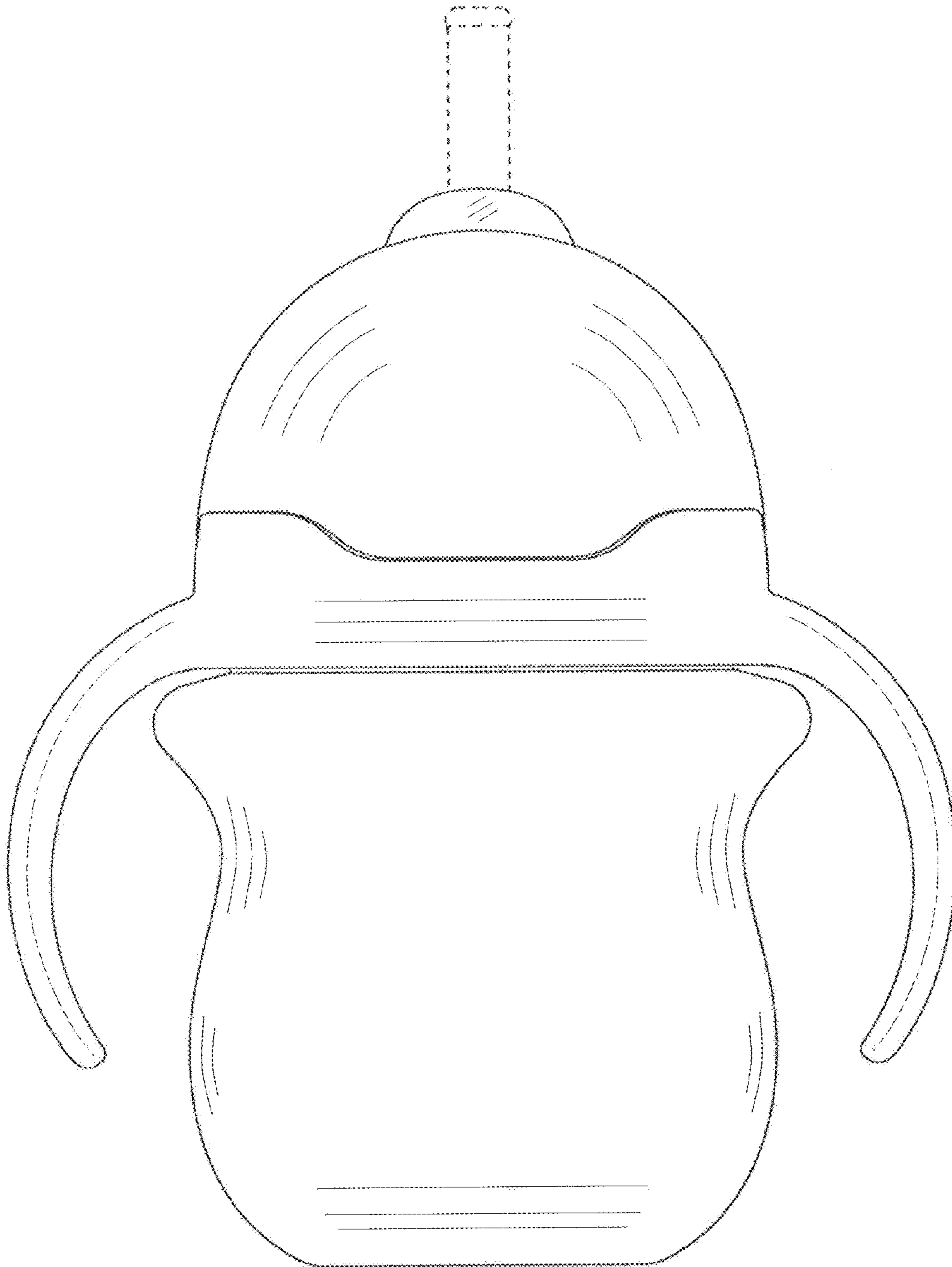

FIG. 4

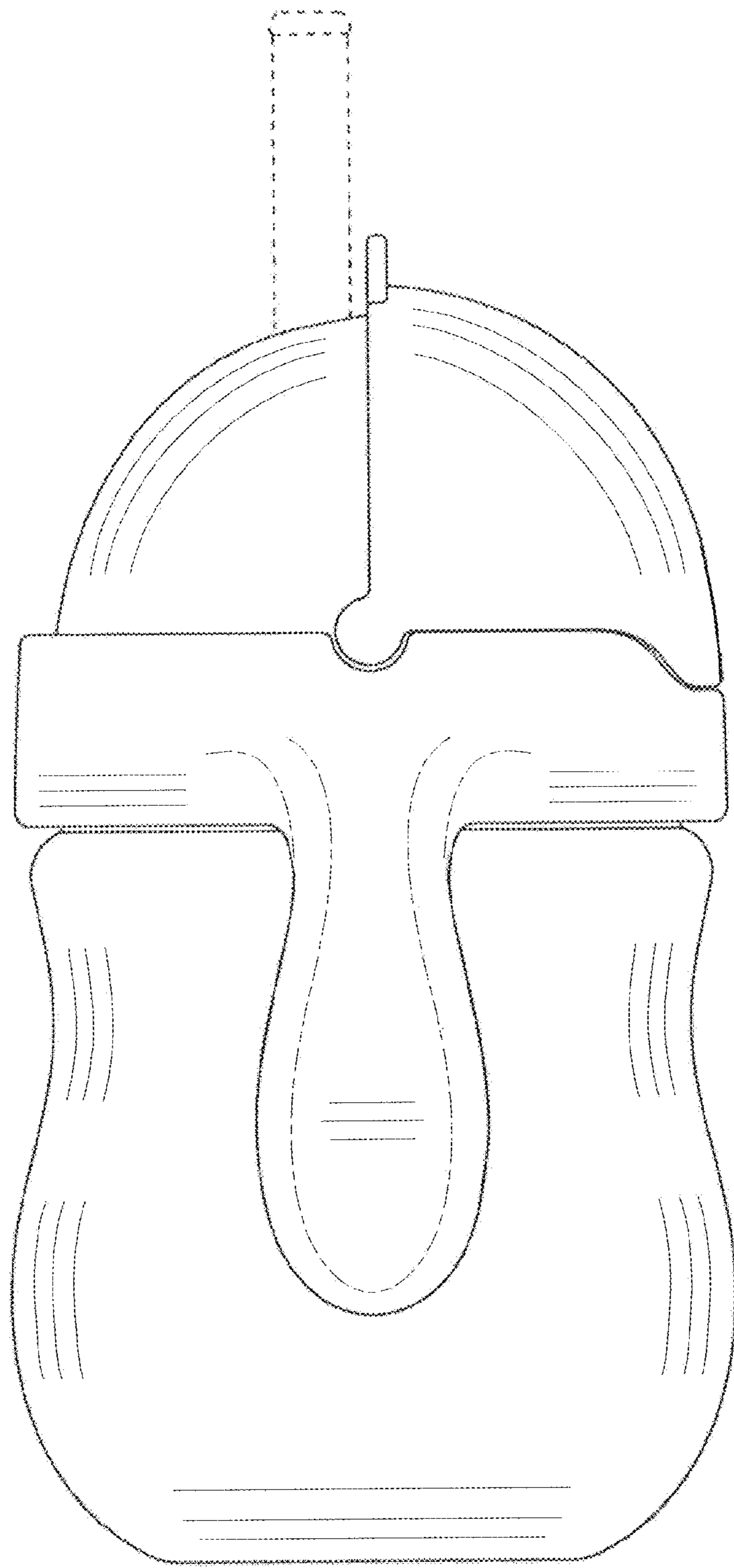

FIG. 5

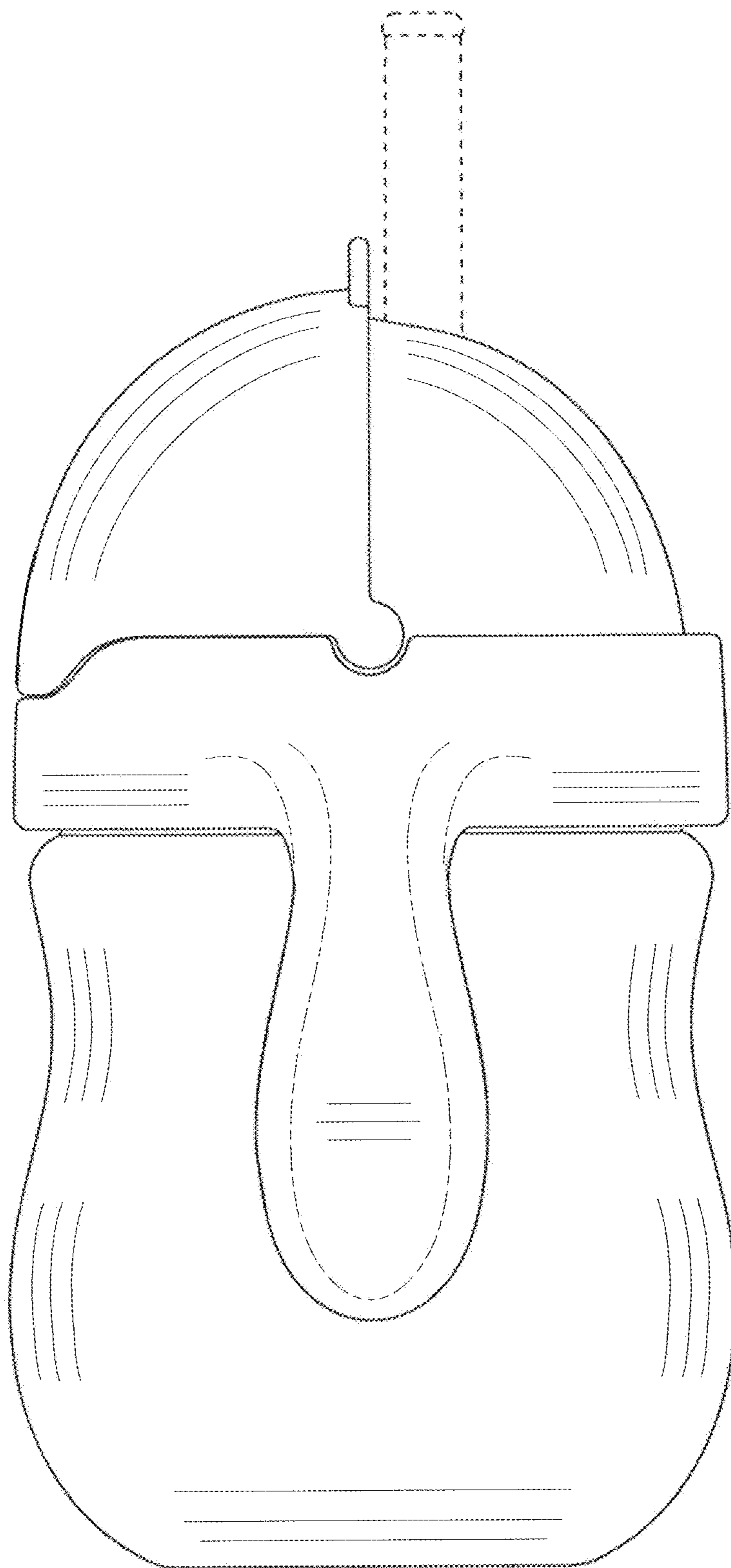

FIG. 6



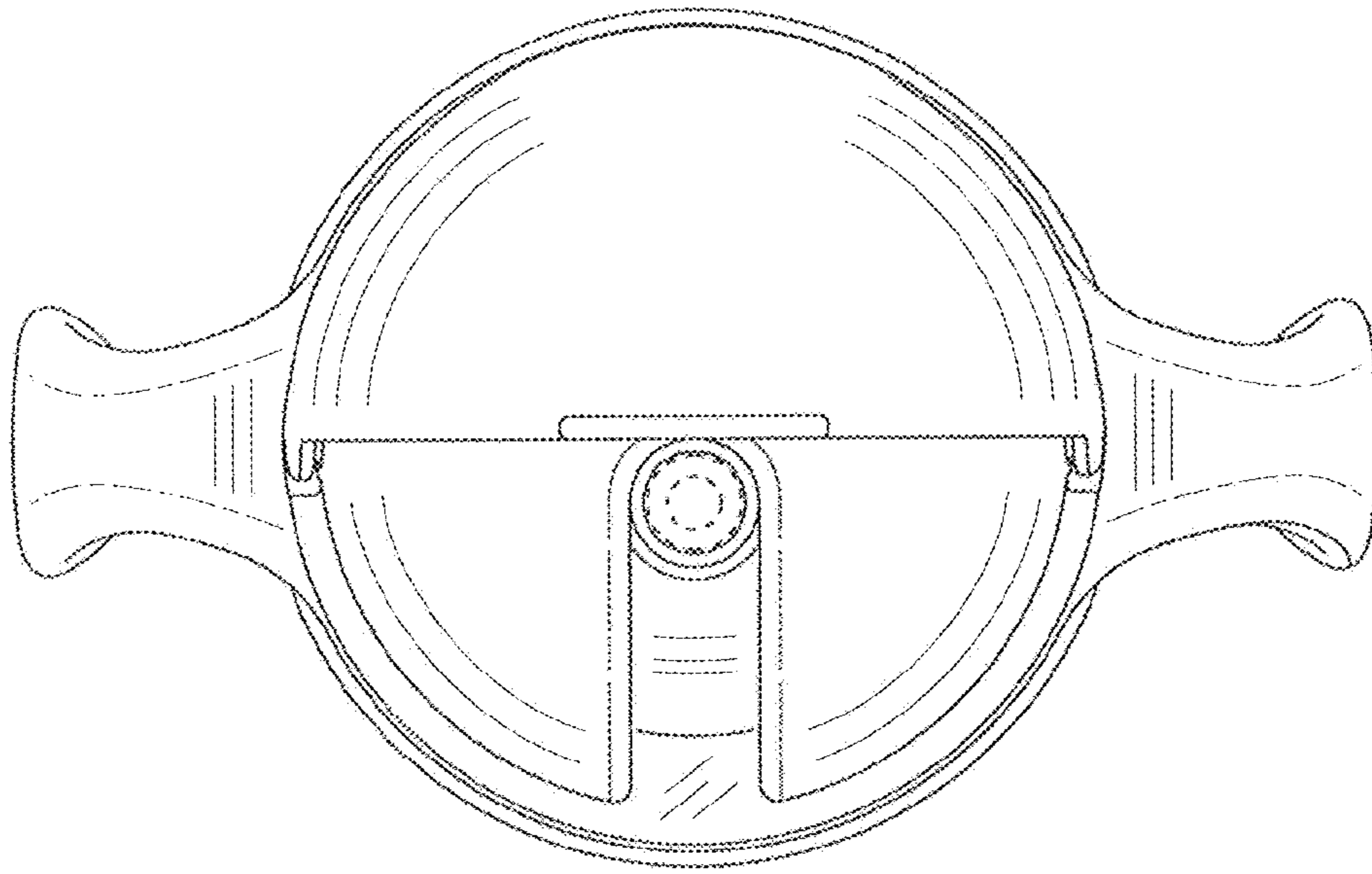

FIG. 7

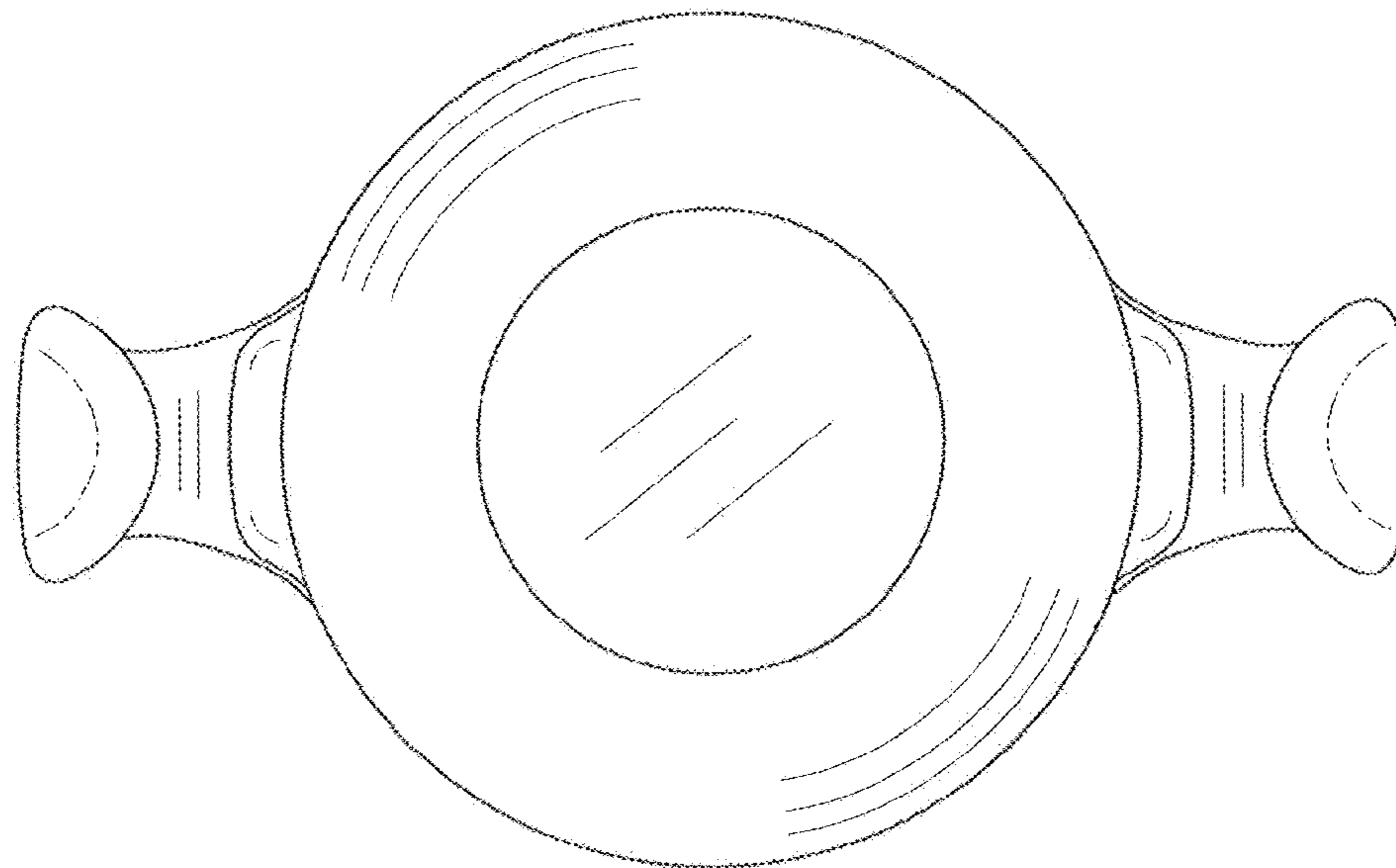

FIG. 8