



US00D730450S

(12) **United States Design Patent**
Frenzel et al.

(10) **Patent No.:** **US D730,450 S**

(45) **Date of Patent:** **** May 26, 2015**

(54) **REAR PORTION OF A VEHICLE, TOY,
AND/OR REPLICAS THEREOF**

(71) Applicant: **Daimler AG**, Stuttgart (DE)

(72) Inventors: **Klaus Frenzel**, Konstanz-Wallhausen (DE); **Hans-Dieter Futschik**, Gechingen (DE); **Steffen Koehl**, Stuttgart (DE); **Robert Lesnik**, Leonberg (DE); **Gorden Wagener**, Gaeufelden (DE)

(73) Assignee: **Daimler AG**, Stuttgart (DE)

(**) Term: **14 Years**

(21) Appl. No.: **29/499,222**

(22) Filed: **Aug. 13, 2014**

(51) **LOC (10) Cl.** **12-16**

(52) **U.S. Cl.**
USPC **D21/164**

(58) **Field of Classification Search**
CPC B62D 35/001; B62D 31/003; B62D 24/02;
B62D 25/08; B62D 33/00; B62D 25/06
USPC D12/196, 90-92, 86; 296/181.1, 181.5
See application file for complete search history.

(56) **References Cited**

U.S. PATENT DOCUMENTS

D508,004 S *	8/2005	Metros et al.	D12/196
D531,547 S *	11/2006	Hiruta et al.	D12/92
D547,699 S *	7/2007	Okazaki et al.	D12/92
D562,188 S *	2/2008	Matsumoto et al.	D12/92
D573,522 S *	7/2008	Sato et al.	D12/196
D580,331 S *	11/2008	Gueler et al.	D12/196
D580,332 S *	11/2008	Gueler et al.	D12/196
D592,117 S *	5/2009	Ward	D12/196
D592,555 S *	5/2009	Kanno et al.	D12/92
D598,355 S *	8/2009	Sato et al.	D12/196
D598,813 S *	8/2009	Hiranaka et al.	D12/92
D598,822 S *	8/2009	Hiranaka et al.	D12/164

D598,823 S *	8/2009	Hiranaka et al.	D12/164
D601,072 S *	9/2009	Giachin	D12/196
D602,399 S *	10/2009	Sakae et al.	D12/91
D602,821 S *	10/2009	Tada et al.	D12/164
D605,101 S *	12/2009	Mueller	D12/196
D605,572 S *	12/2009	Ward	D12/196
D620,841 S *	8/2010	Sakae et al.	D12/92
D622,186 S *	8/2010	Miyata et al.	D12/92
D622,191 S *	8/2010	Yagi et al.	D12/164
D630,555 S *	1/2011	Koshino et al.	D12/92
D633,838 S *	3/2011	Loeb	D12/196
D633,839 S *	3/2011	Matei et al.	D12/196

(Continued)

OTHER PUBLICATIONS

“Mercedes-Benz Concept Coupé SUV, Sporty Coupé at the highest level,” Mercedes-Benz, Press Information, Apr. 20, 2014, Stuttgart, Germany.

Primary Examiner — Melody Brown

(74) *Attorney, Agent, or Firm* — Crowell & Moring LLP

(57) **CLAIM**

The ornamental design for a rear portion of a vehicle, toy, and/or replicas thereof, as shown and described.

DESCRIPTION

This application contains subject matter related to the following co-pending U.S. design patent application: Application Ser. No. 29/499,221, filed herewith and entitled “Vehicle, Toy, and/or Replicas Thereof”.

FIG. 1 is a left, rear perspective view of a rear portion of a vehicle, toy, and/or replicas thereof according to the design; FIG. 2 is a left, front perspective view thereof; FIG. 3 is a left side view thereof; FIG. 4 is a right side view thereof; FIG. 5 is a front view thereof; and, FIG. 6 is a top view thereof.

The broken lines are for illustrative purposes only and form no part of the claimed design.

1 Claim, 6 Drawing Sheets

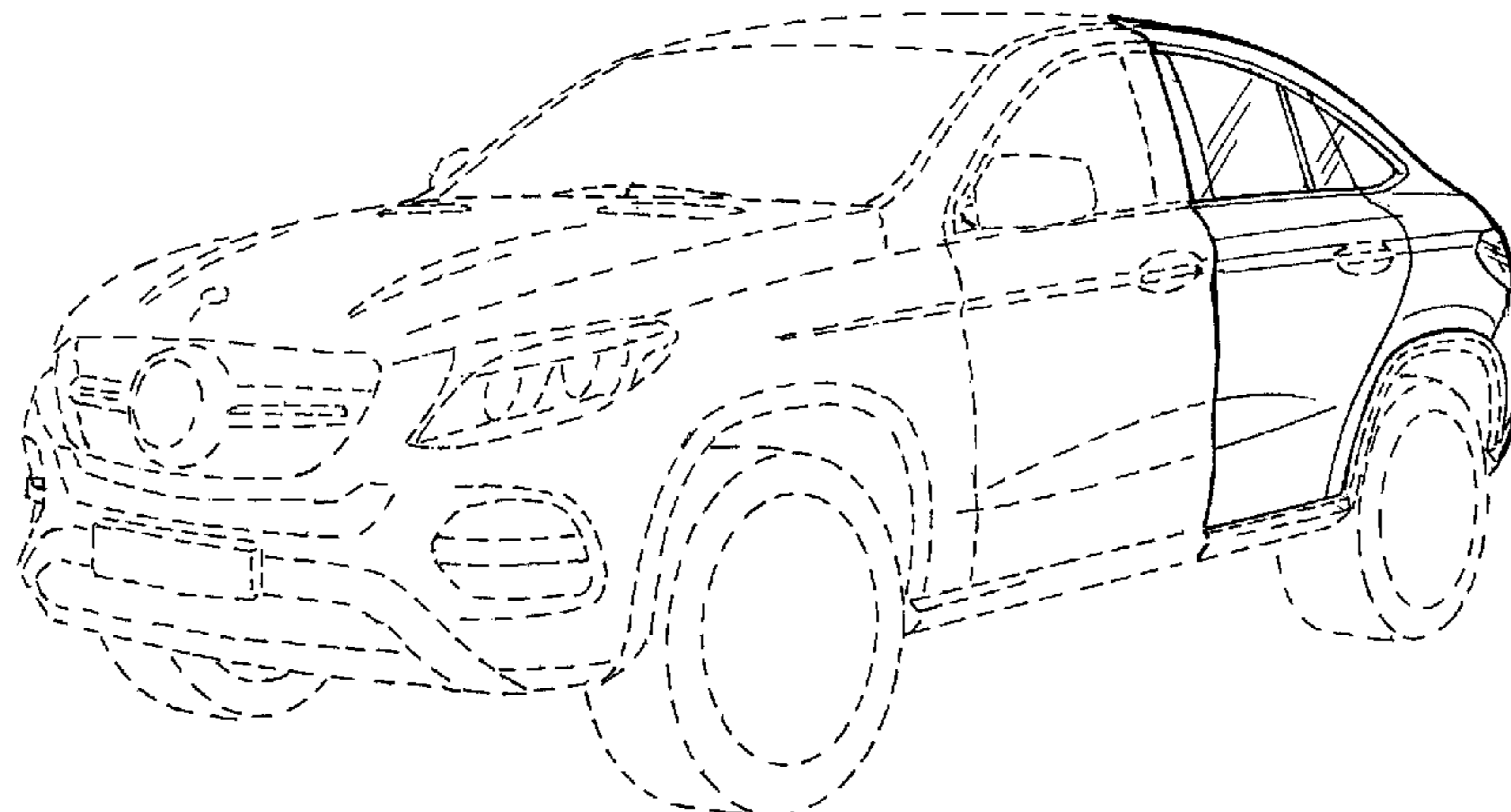

(56)

References Cited

U.S. PATENT DOCUMENTS

D636,317 S * 4/2011 Matei et al. D12/196
D655,230 S * 3/2012 Nishihama D12/196
D671,032 S * 11/2012 Frei et al. D12/91
D671,868 S * 12/2012 Tomatsu et al. D12/164

D673,485 S * 1/2013 Yamada et al. D12/164
D698,289 S * 1/2014 Kwon et al. D12/164
D699,658 S * 2/2014 Jevremovic et al. D12/196
D700,876 S * 3/2014 Jevremovic et al. D12/196
D711,791 S * 8/2014 Futschik et al. D12/164
D714,695 S * 10/2014 Kim et al. D12/164
D715,706 S * 10/2014 Futschik et al. D12/164

* cited by examiner

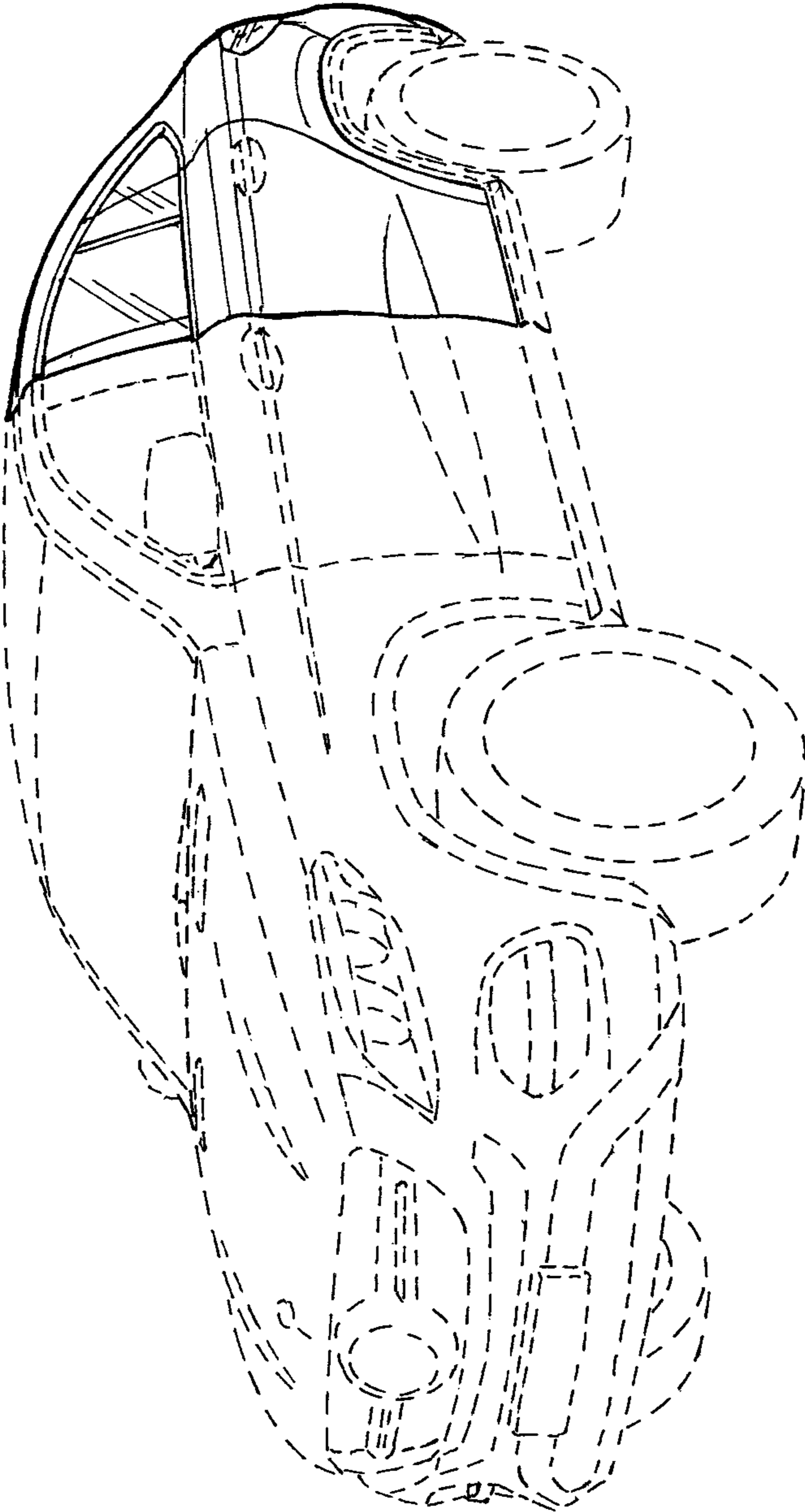

FIG. 1

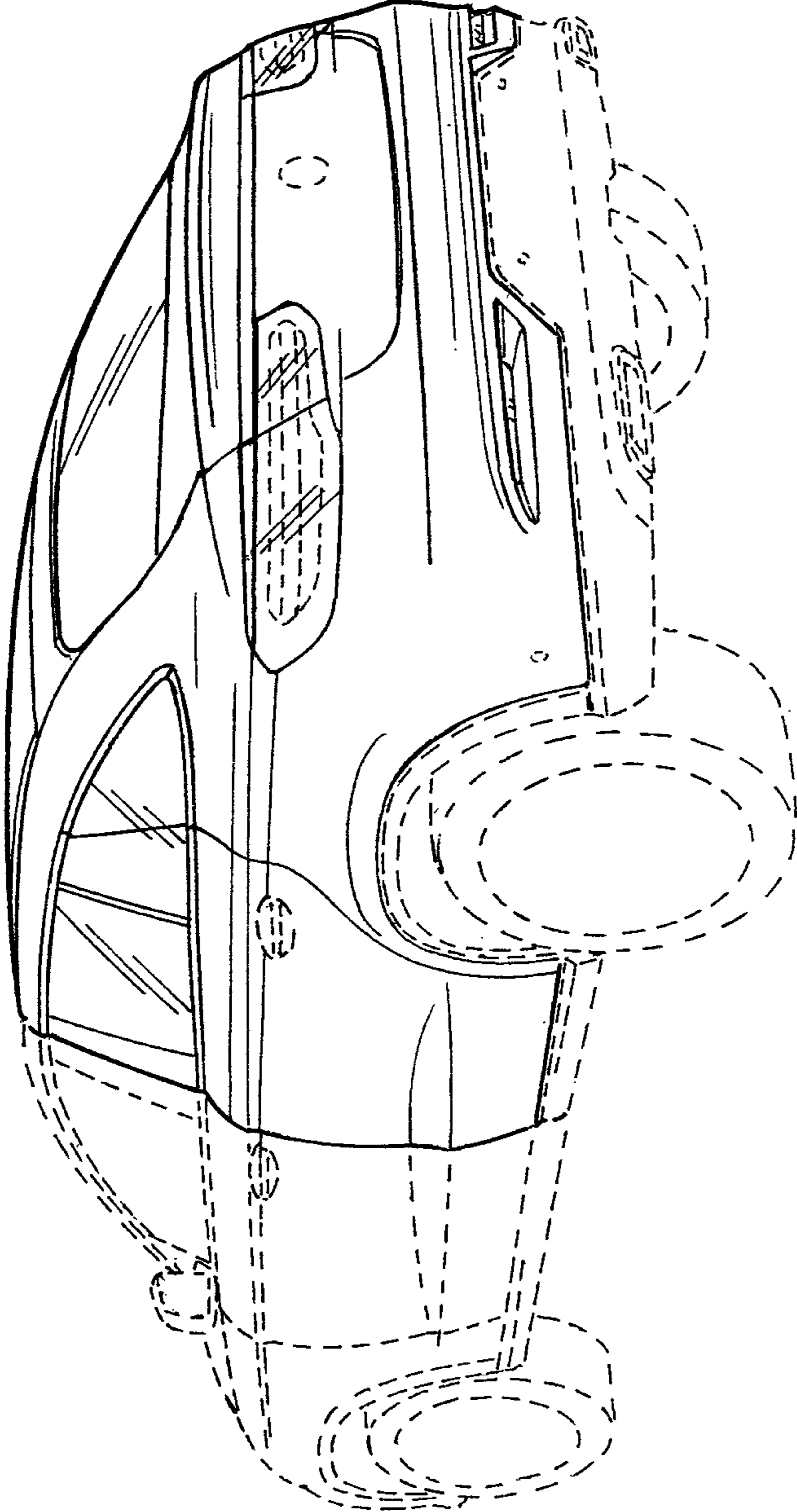

FIG. 2

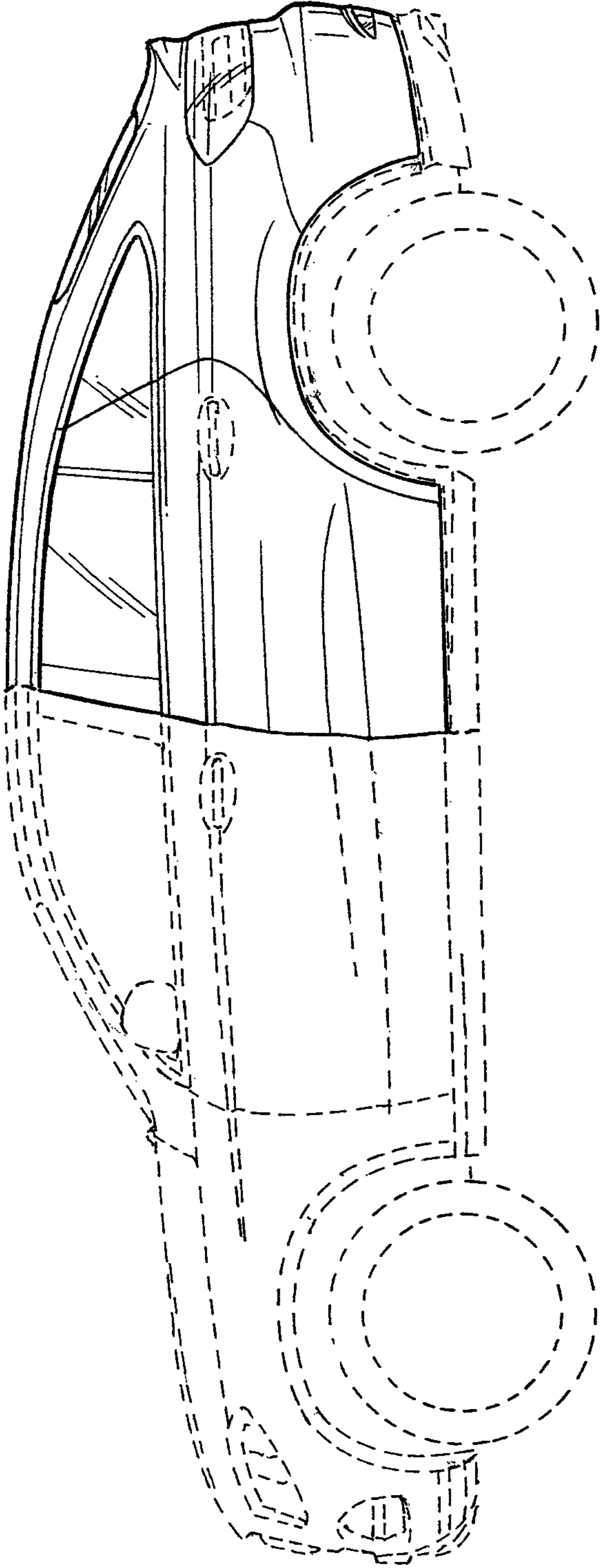

FIG. 3

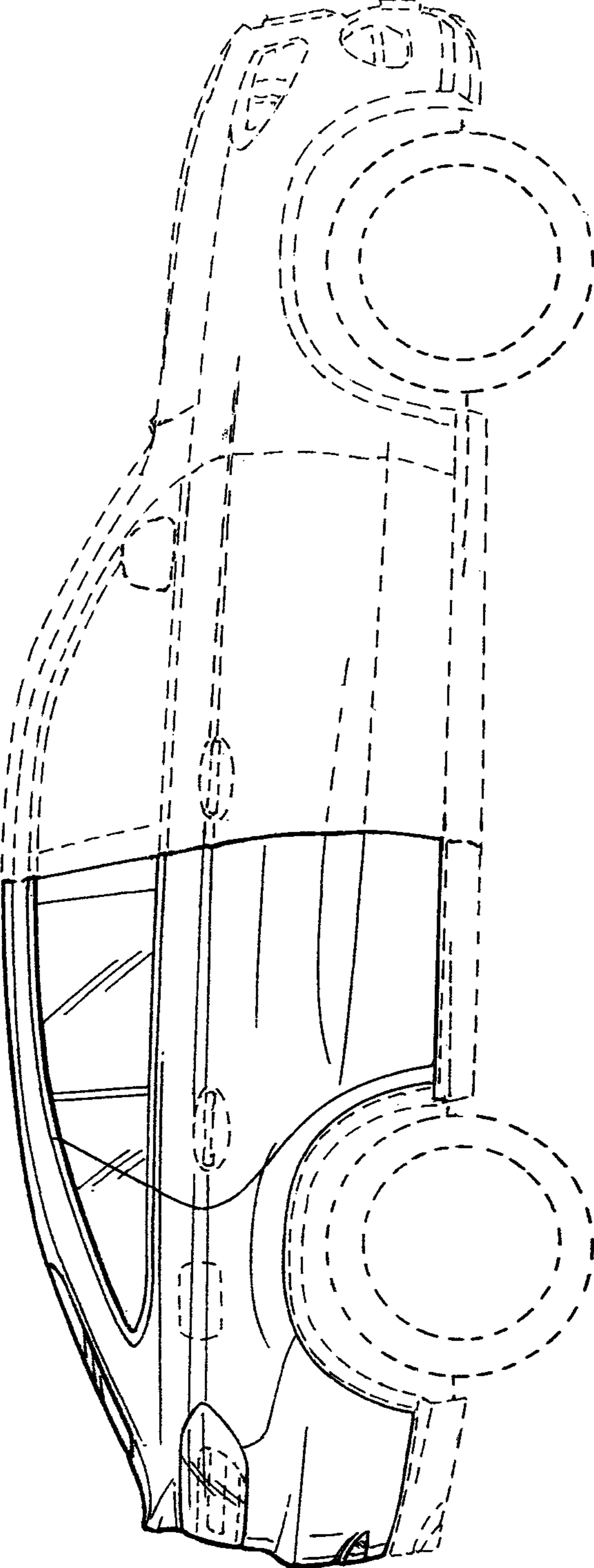

FIG. 4

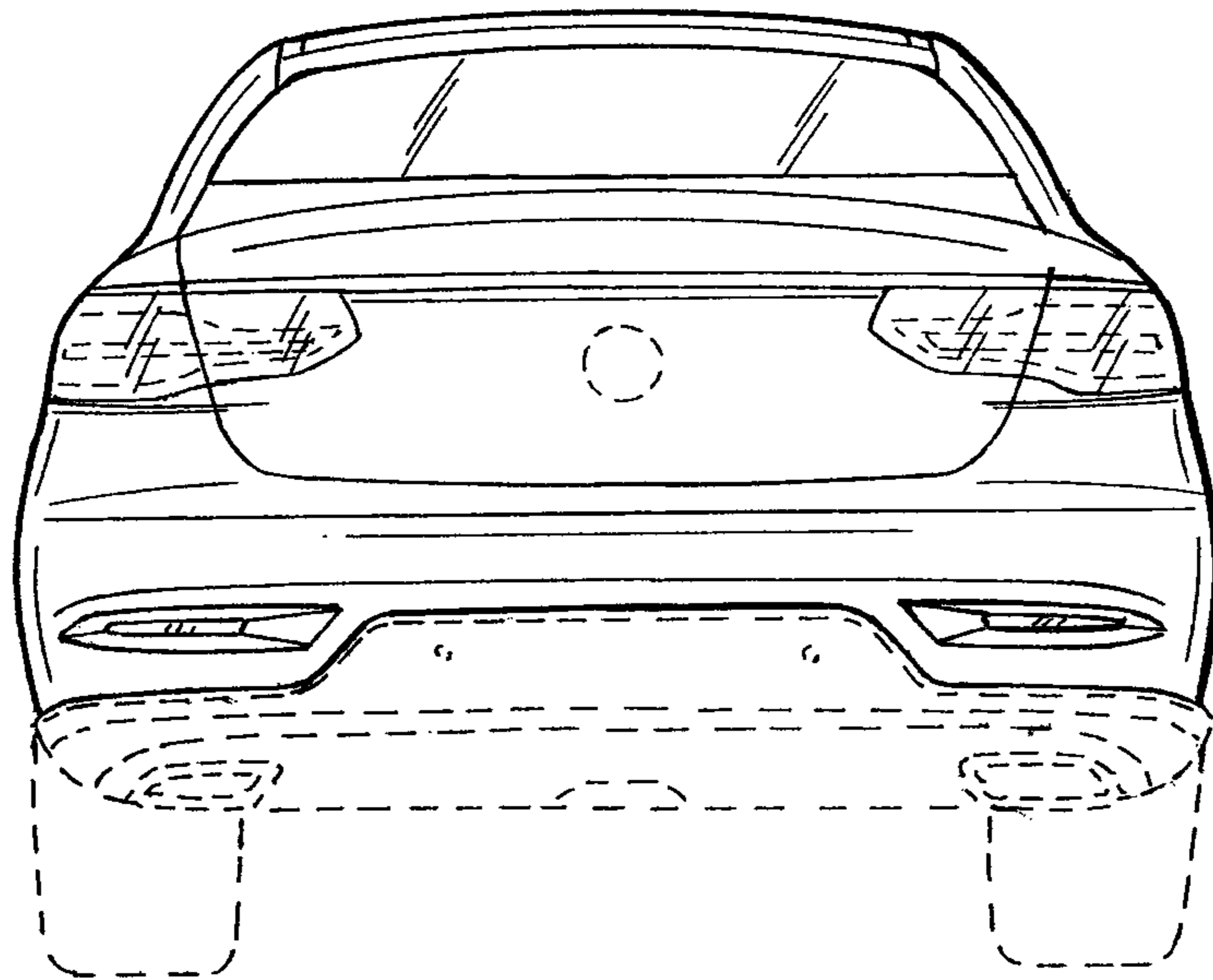

FIG. 5

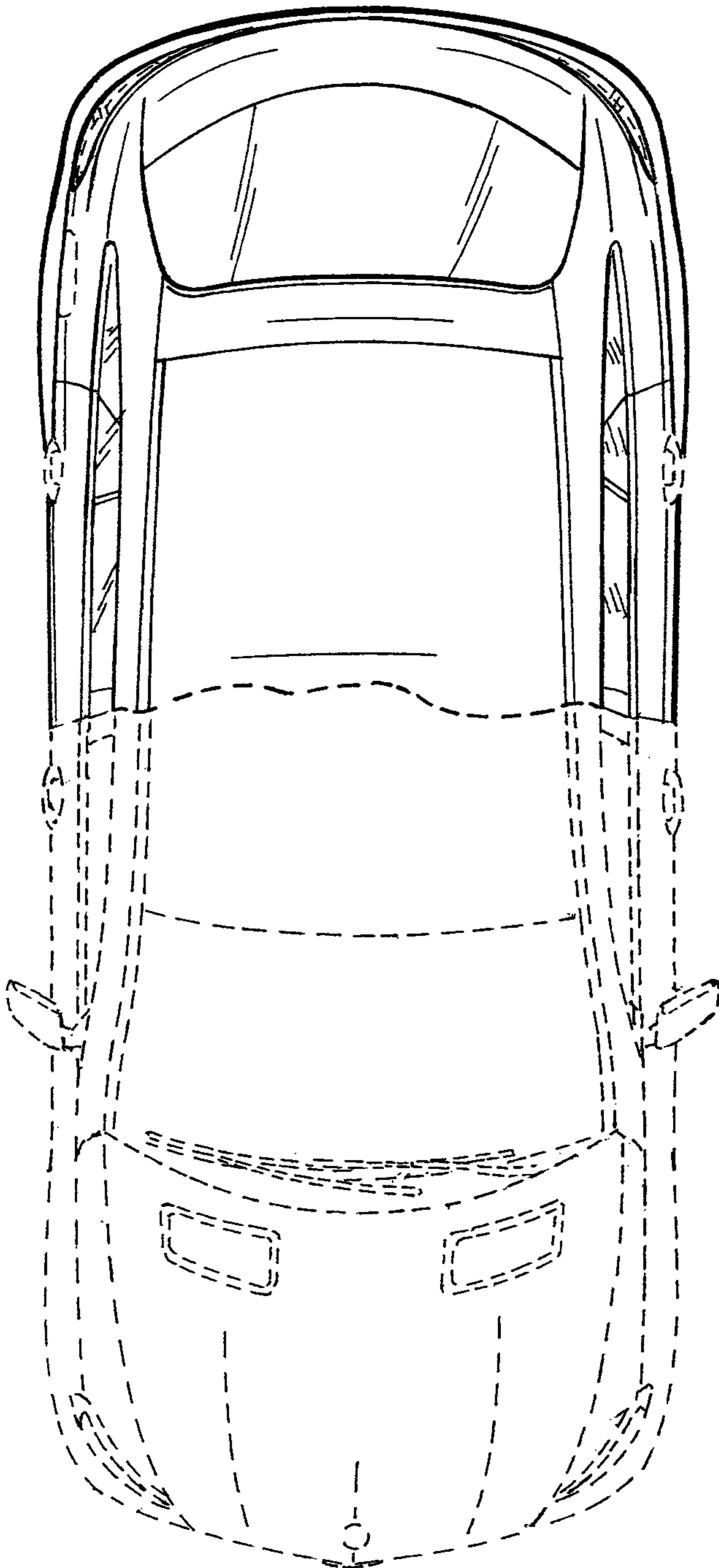

FIG. 6