



US00D730441S

(12) **United States Design Patent**
Joshi

(10) **Patent No.:** **US D730,441 S**
(45) **Date of Patent:** **** May 26, 2015**

(54) **COMBINED DECORATIVE COMPOSITION BOOK AND PLANNER**

(71) Applicant: **Leela Ivie Joshi**, Brooklyn, NY (US)

(72) Inventor: **Leela Ivie Joshi**, Brooklyn, NY (US)

(**) Term: **14 Years**

(21) Appl. No.: **29/460,568**

(22) Filed: **Jul. 12, 2013**

(51) **LOC (10) Cl.** **19-04**

(52) **U.S. Cl.**
USPC **D19/26**

(58) **Field of Classification Search**

USPC D19/26, 27, 28, 100; D3/900; 281/3.1, 281/15.1, 16, 21.1, 22, 27, 27.3, 28, 29, 35, 281/36, 37, 51; 402/8, 57, 73, 74, 78, 80 R; 462/7, 17, 55, 84

See application file for complete search history.

(56) **References Cited**

U.S. PATENT DOCUMENTS

259,975 A * 6/1882 Campbell 281/16
288,277 A * 11/1883 Tebbetts 281/16

(Continued)

FOREIGN PATENT DOCUMENTS

EP 0666802 B1 8/1998

OTHER PUBLICATIONS

<http://www.designboom.com/design/the-worlds-first-whole-brain-notebook/>, printed from the web on Sep. 17, 2013.

Primary Examiner — Sheryl Lane

Assistant Examiner — Ieisha Price

(74) *Attorney, Agent, or Firm* — Scully, Scott, Murphy & Presser, P.C.

(57) **CLAIM**

The ornamental design for a combined decorative composition book and planner, as shown and described.

DESCRIPTION

FIG. 1 is a perspective view of the combined decorative composition book and planner showing my new design.

FIG. 2 is a front view of the combined decorative composition book and planner showing my new design.

FIG. 3 is a rear view of the combined decorative composition book and planner showing my new design.

FIG. 4 is a left-side view of the combined decorative composition book and planner showing my new design.

FIG. 5 is a right-side view of the combined decorative composition book and planner showing my new design.

FIG. 6 is a top view of the combined decorative composition book and planner showing my new design.

FIG. 7 is a bottom view of the combined decorative composition book and planner showing my new design.

FIG. 8 is a perspective view of the combined decorative composition book and planner, showing its first open position configuration thereof.

FIG. 9 is a perspective view of the combined decorative composition book and planner, showing its second open position configuration thereof.

FIG. 10 is a perspective view of the combined decorative composition book and planner, showing its third open position configuration thereof.

FIG. 11 is a perspective view of the combined decorative composition book and planner, showing its fourth open position configuration thereof.

FIG. 12 is a perspective view of the combined decorative composition book and planner, showing its fifth open position configuration thereof.

FIG. 13 is a perspective view of the combined decorative composition book and planner, showing its sixth open position configuration thereof.

FIG. 14 is a perspective view of the combined decorative composition book and planner, showing its seventh open position configuration thereof.

FIG. 15 is a perspective view of the combined decorative composition book and planner, showing its eighth open position configuration thereof.

FIG. 16 is a perspective view of the combined decorative composition book and planner, showing its ninth open position configuration thereof; and,

FIG. 17 is a perspective view of the combined decorative composition book and planner, showing its tenth open position configuration thereof.

The design is directed to the ornamentation applied to the combined decorative composition book and planner. The broken lines in the drawings illustrate portions of the decorative composition book and planner and form no part of the claimed design.

1 Claim, 17 Drawing Sheets

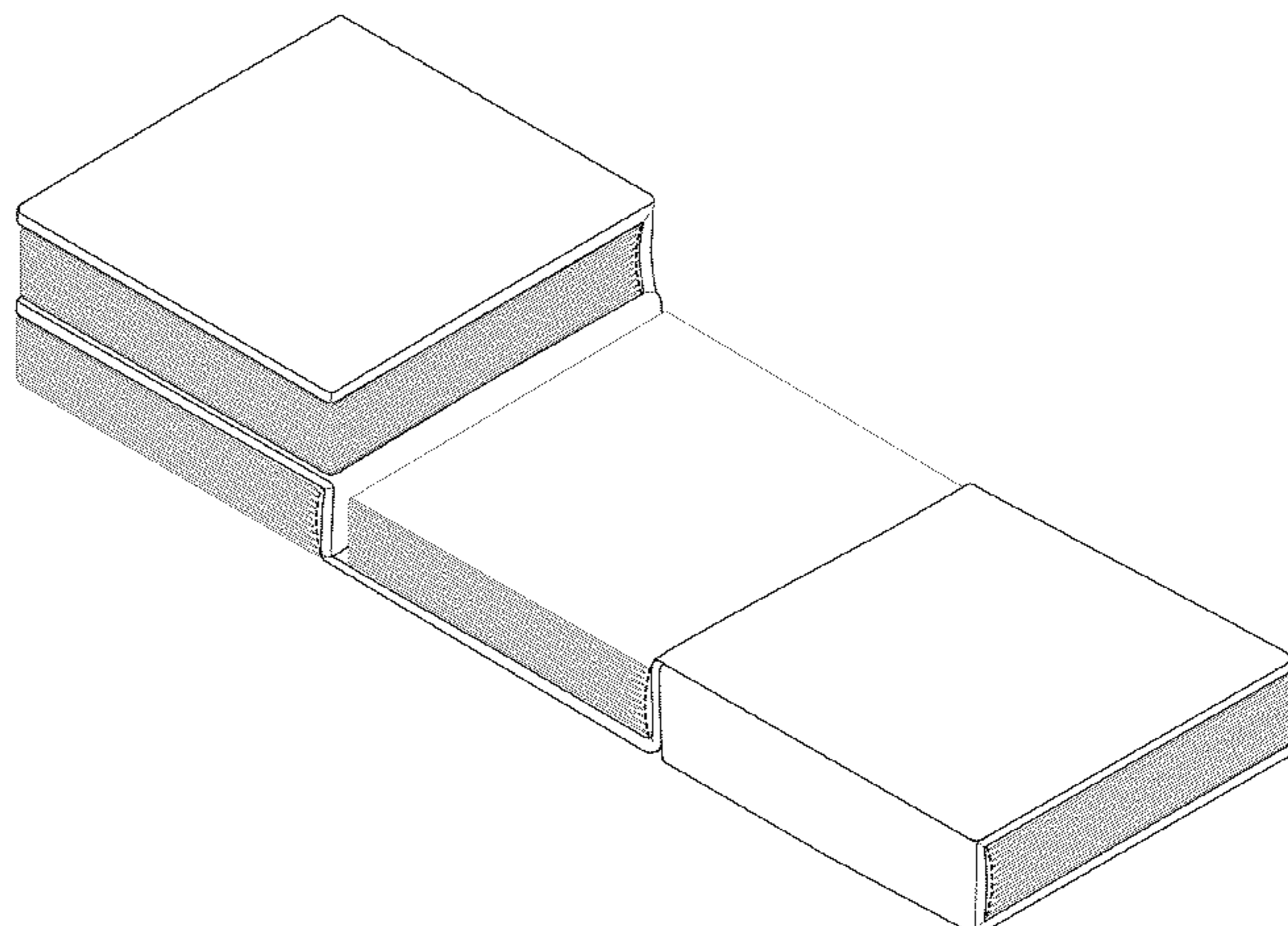
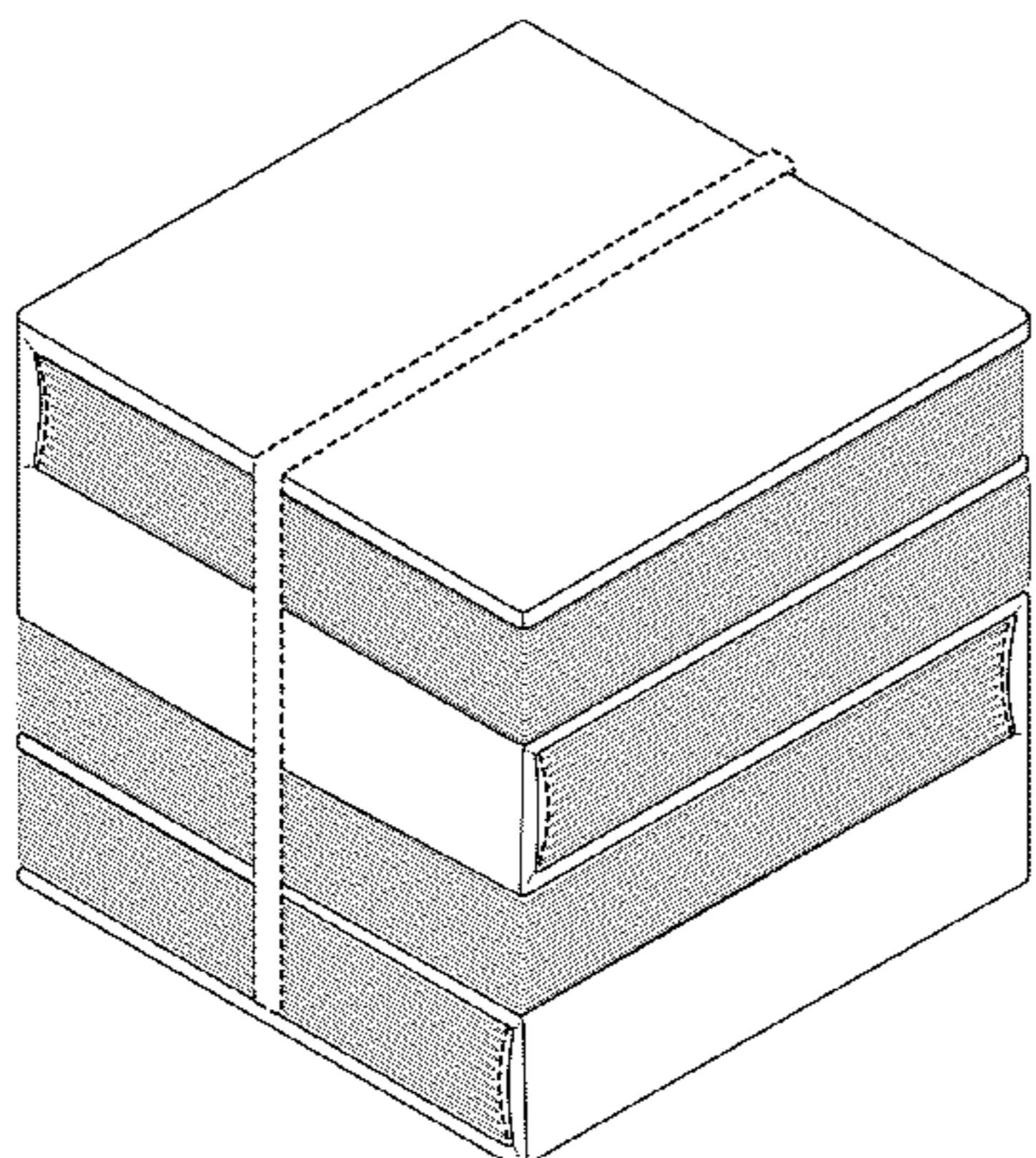

(56)

References Cited

U.S. PATENT DOCUMENTS

950,721 A *	3/1910	Jay	281/16	5,294,208 A	3/1994	Tremmel, Jr. et al.	
1,913,818 A *	6/1933	Petrick	281/16	5,358,278 A	10/1994	Ellis	
2,108,462 A *	2/1938	Wiswall	462/2	5,667,064 A *	9/1997	Bauman	206/214
2,283,584 A *	5/1942	Sloan	281/16	6,702,331 B2 *	3/2004	Derraugh et al.	281/38
RE26,395 E *	5/1968	Schneider	281/39	6,712,396 B2 *	3/2004	Derraugh	281/38
4,280,241 A *	7/1981	Pfaff	412/3	7,780,369 B2	8/2010	Penn et al.	
D320,411 S *	10/1991	Wyant	D19/27	8,173,293 B2 *	5/2012	Kim	429/151
				2003/0132628 A1 *	7/2003	Derraugh	281/38
				2007/0024047 A1 *	2/2007	Richied et al.	281/15.1

* cited by examiner

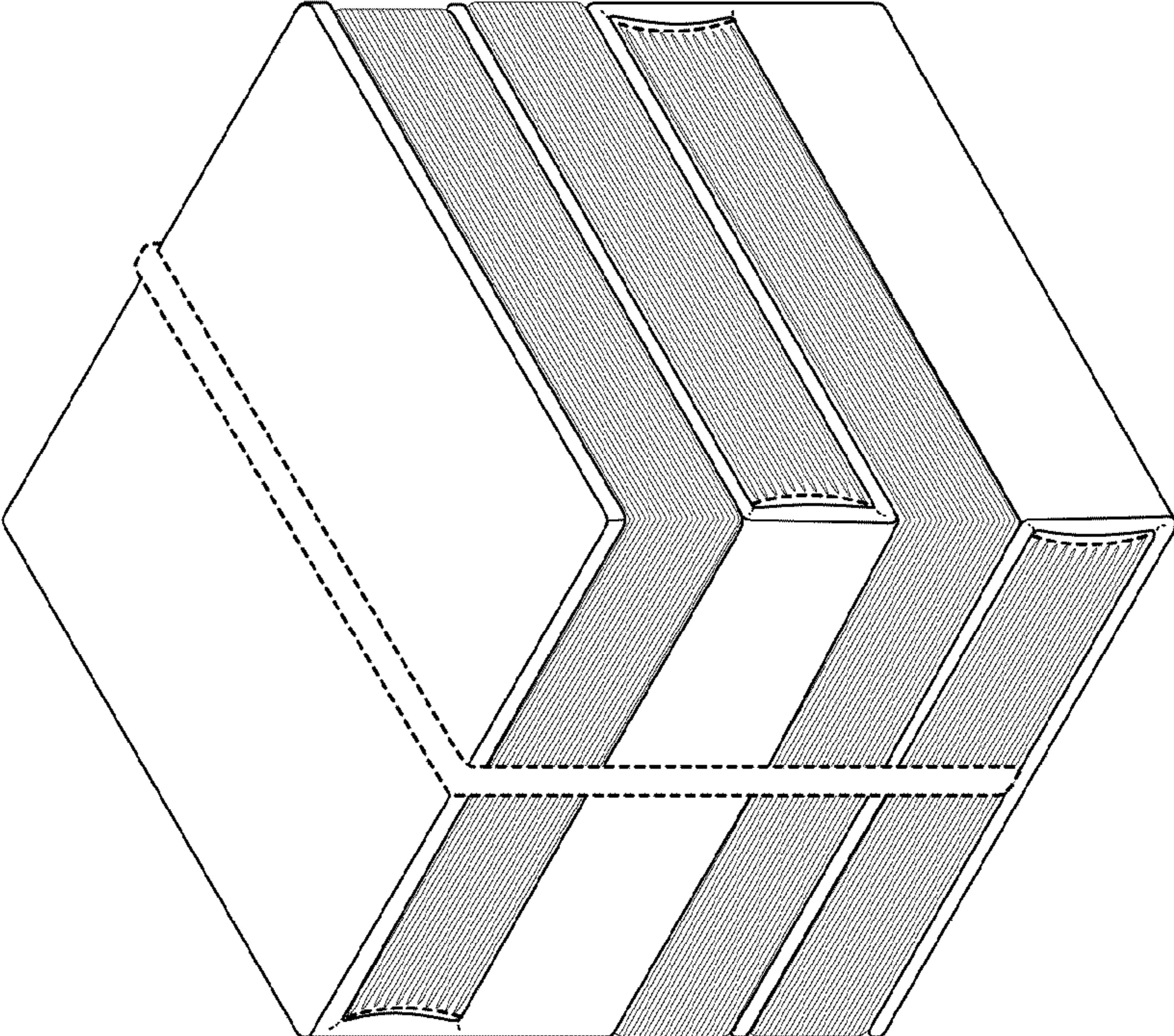

Fig. 1

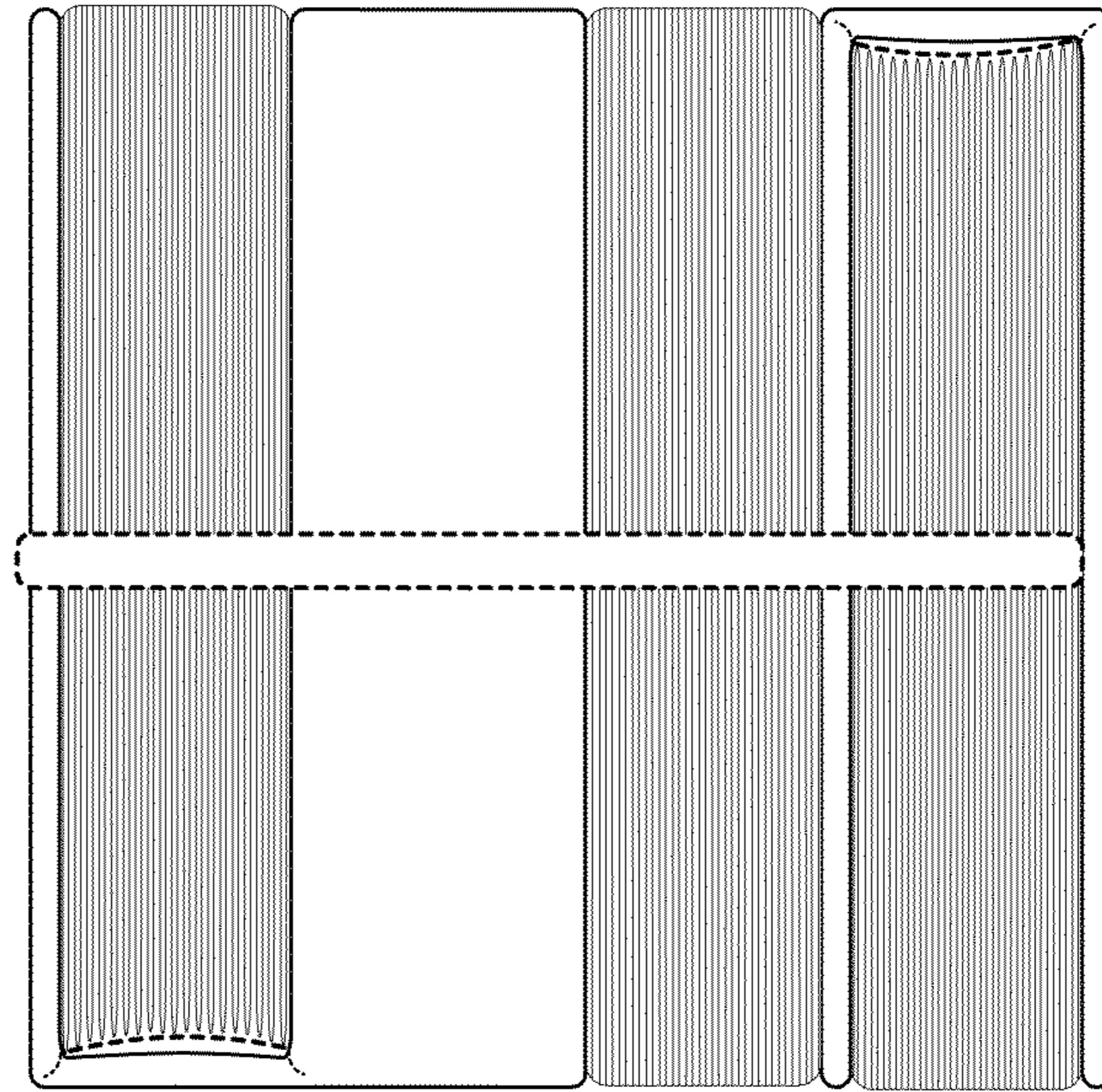

Fig. 2

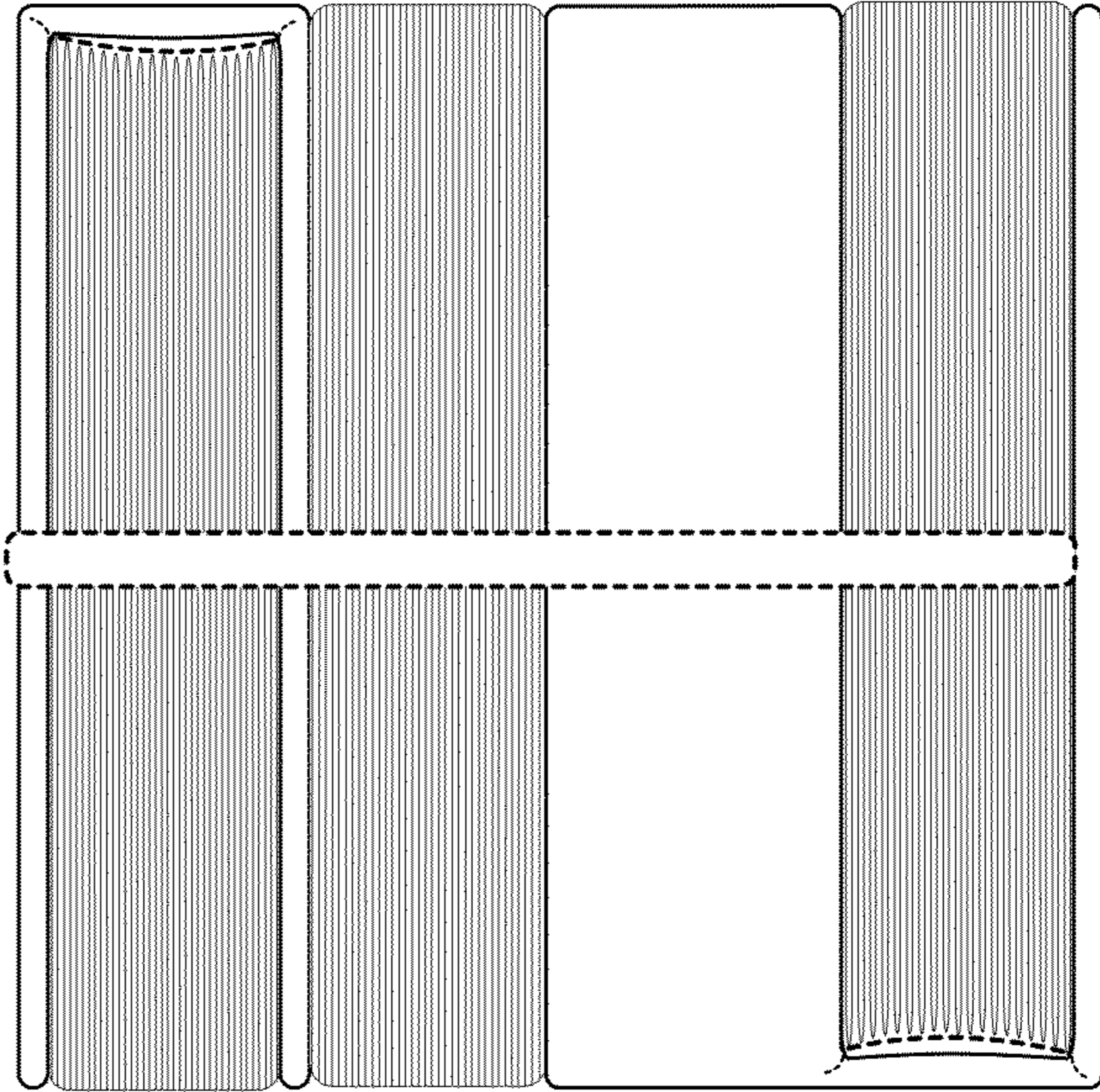

Fig. 3

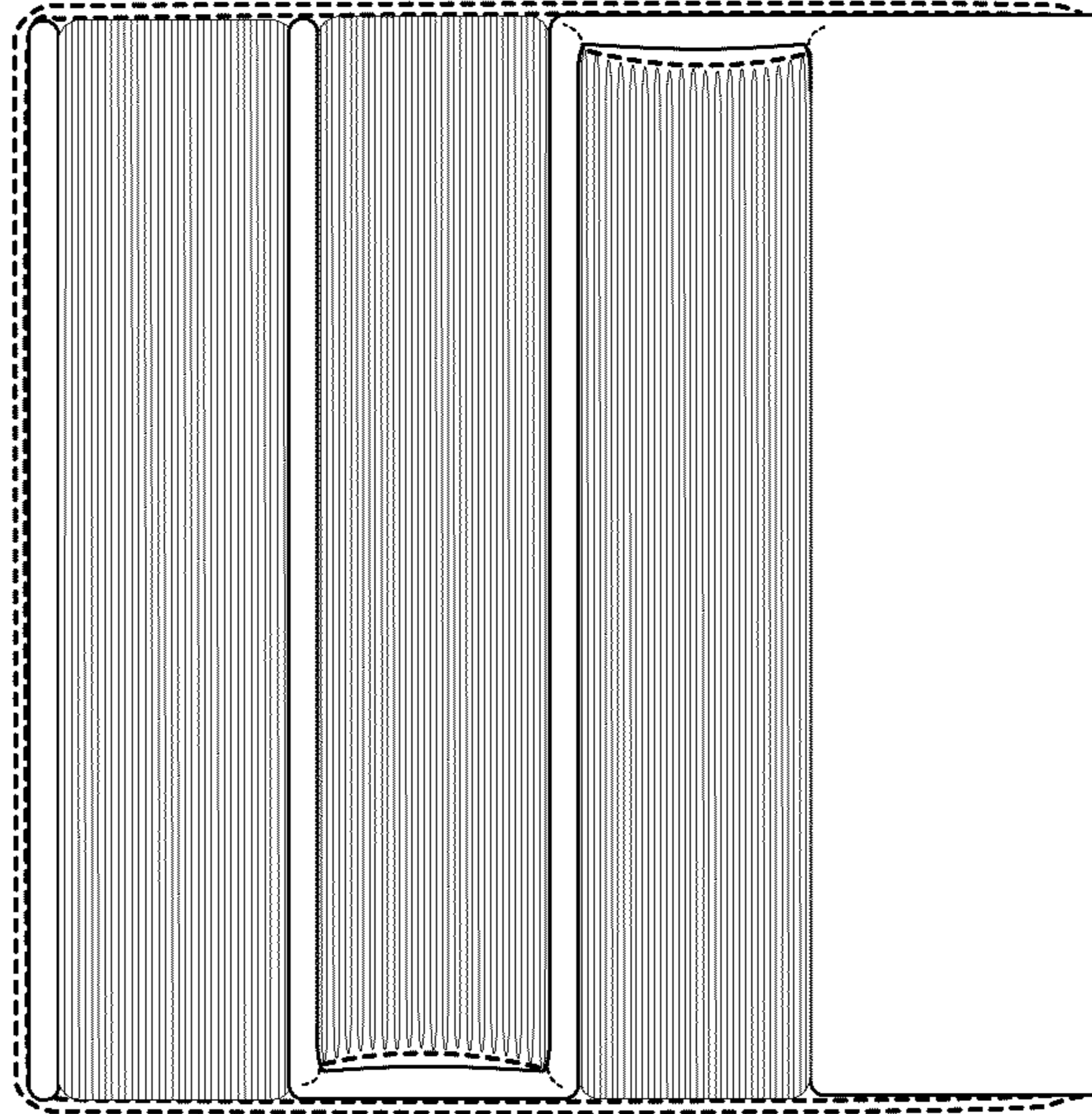

Fig. 4

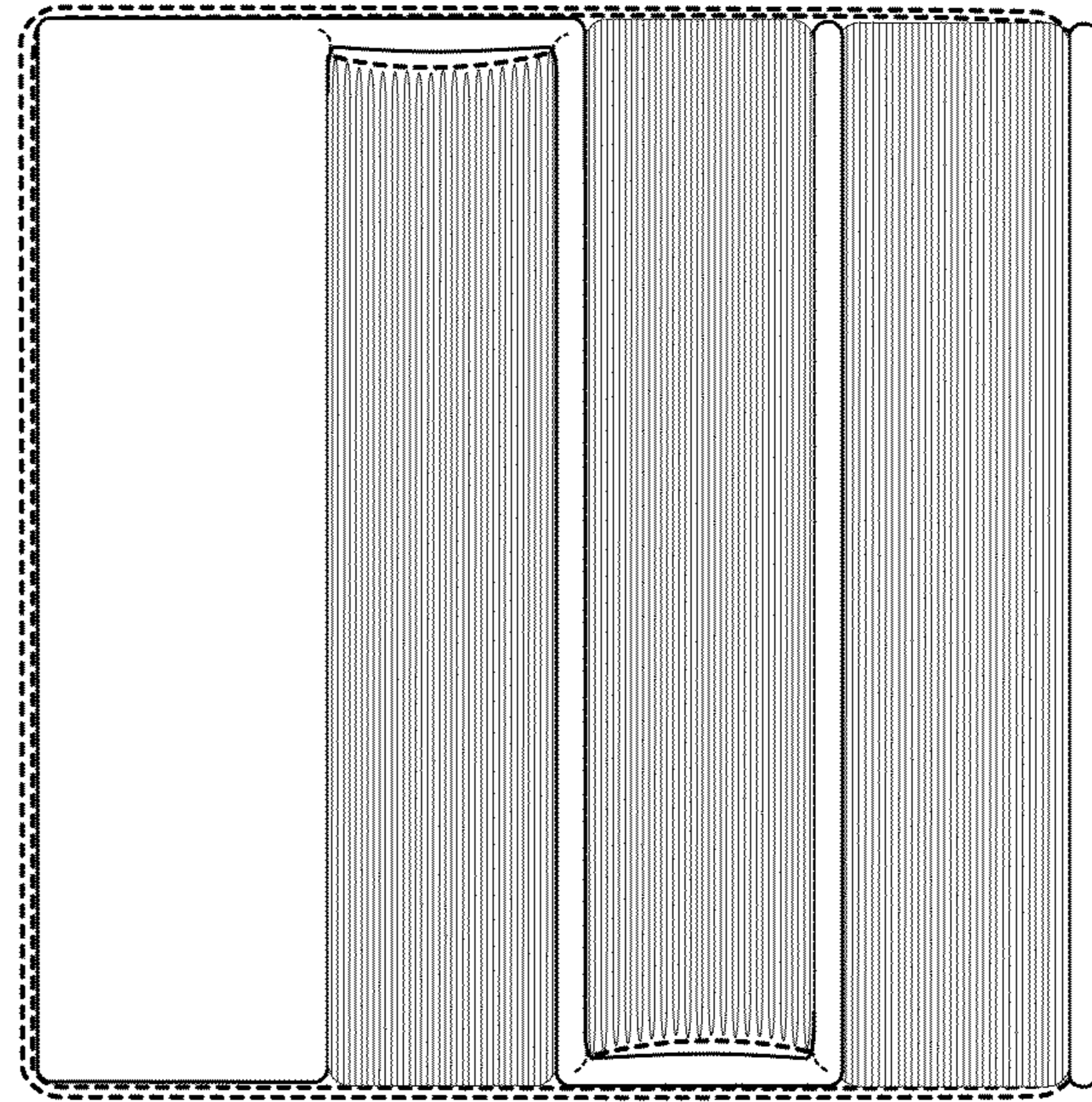

Fig. 5

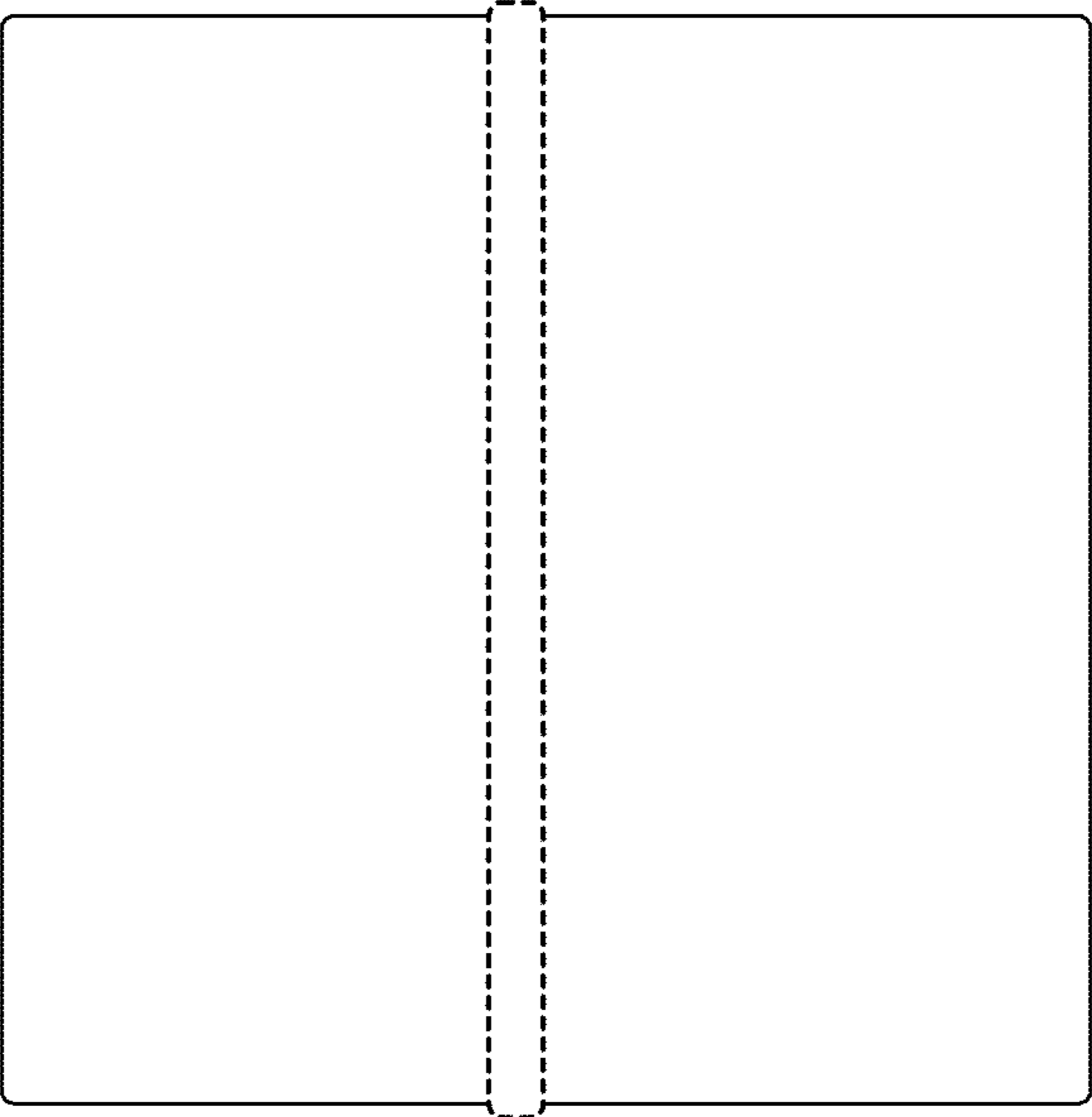

Fig. 6

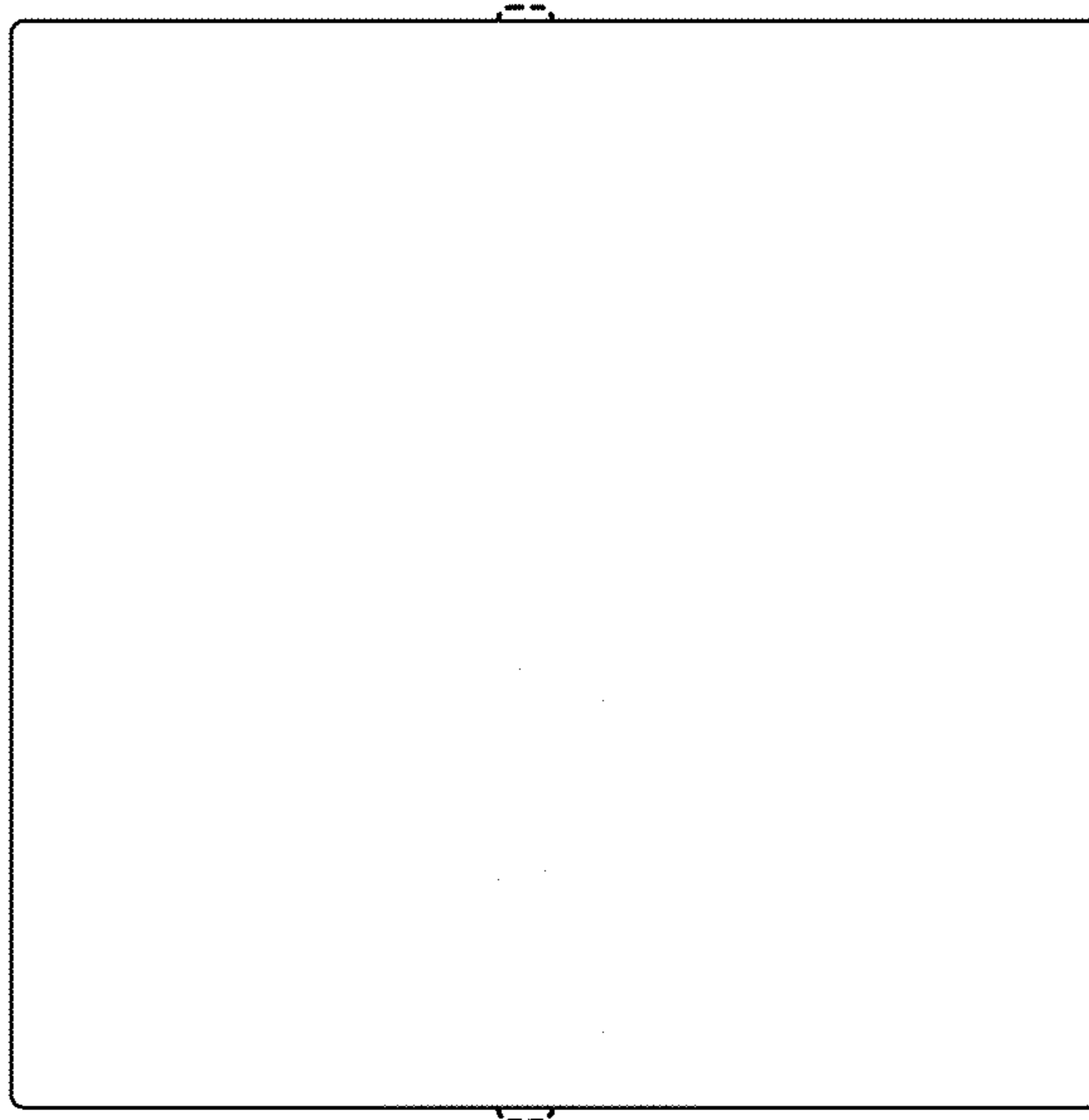

Fig. 7

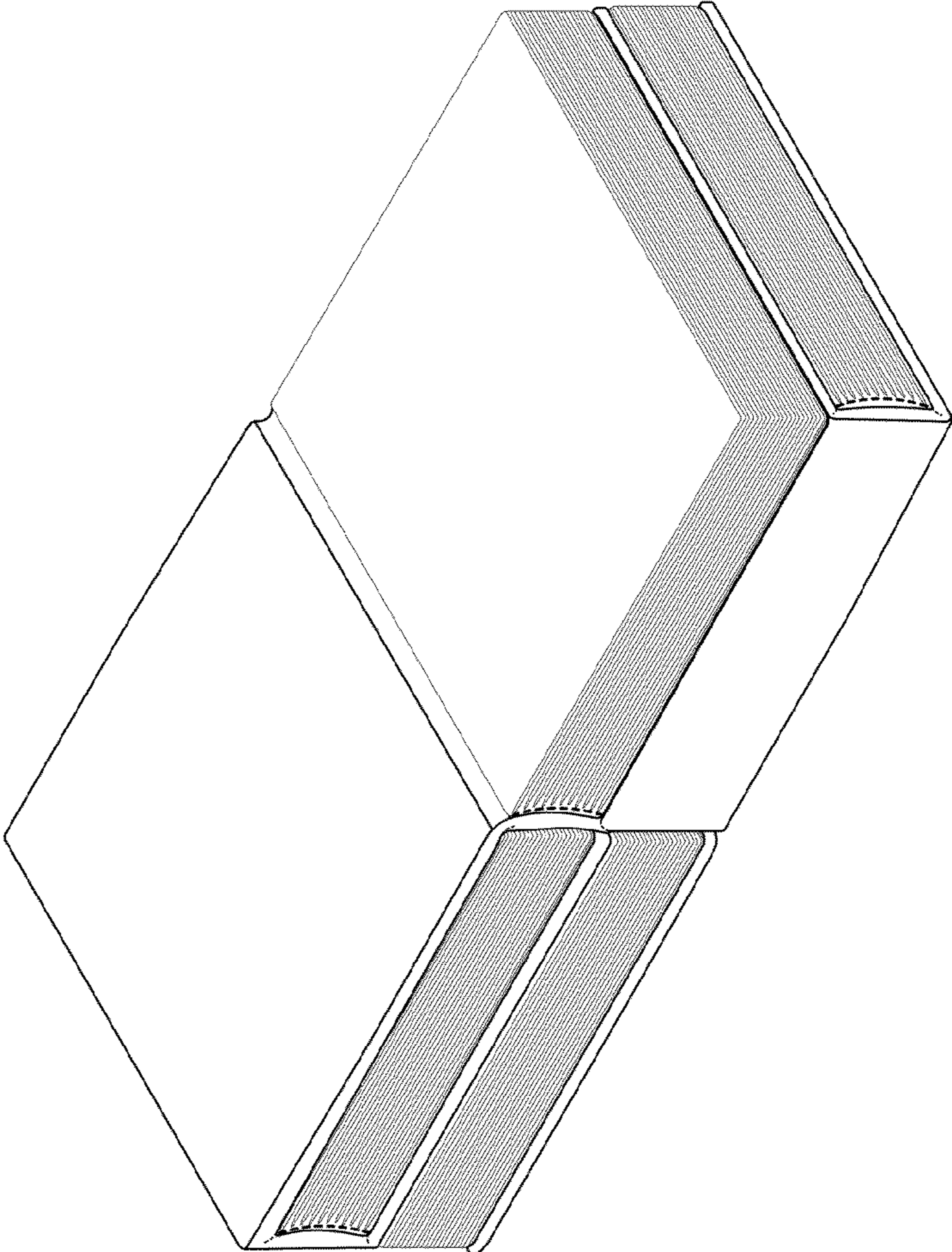

Fig. 8

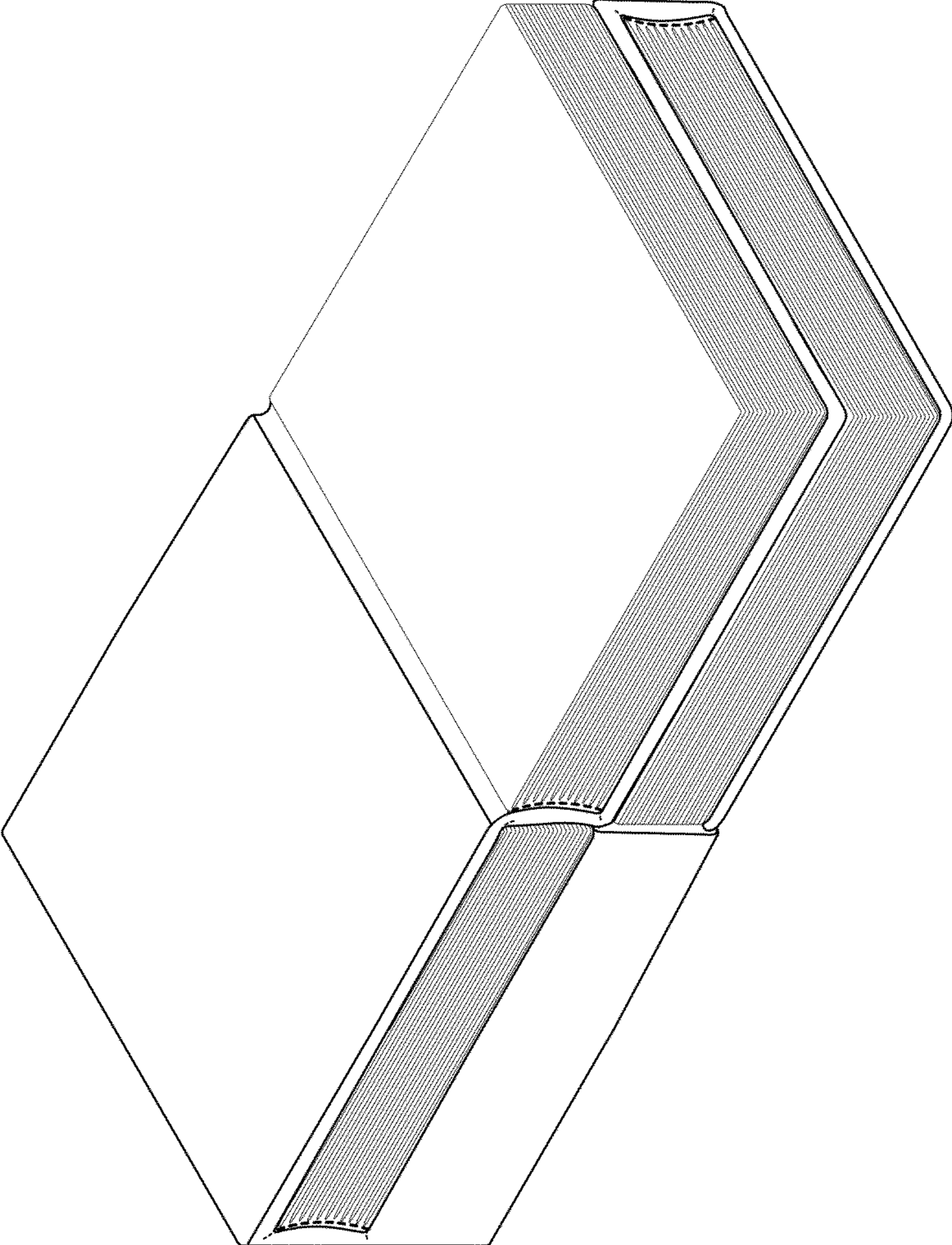

Fig. 9

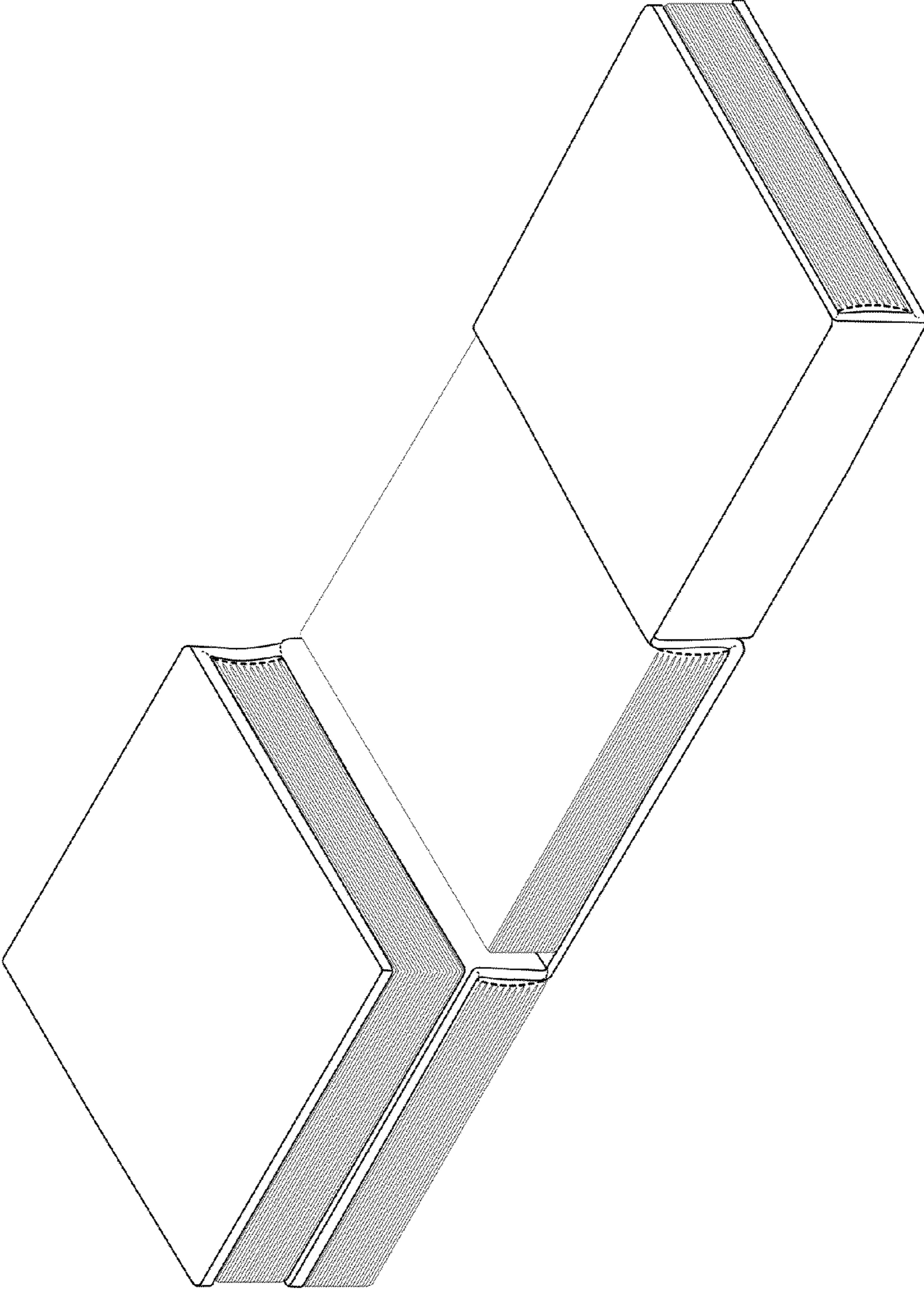

Fig. 10

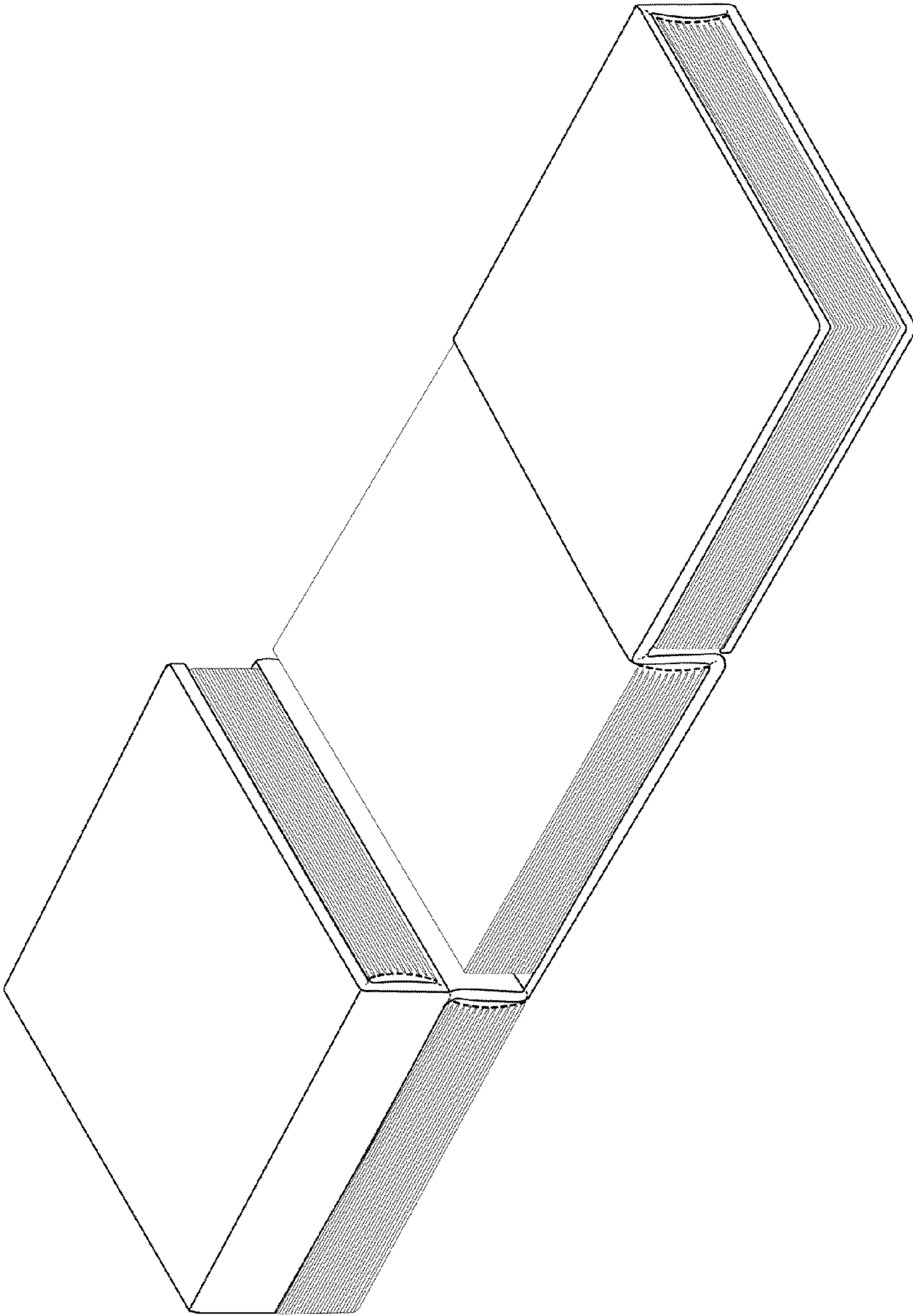

Fig. 11

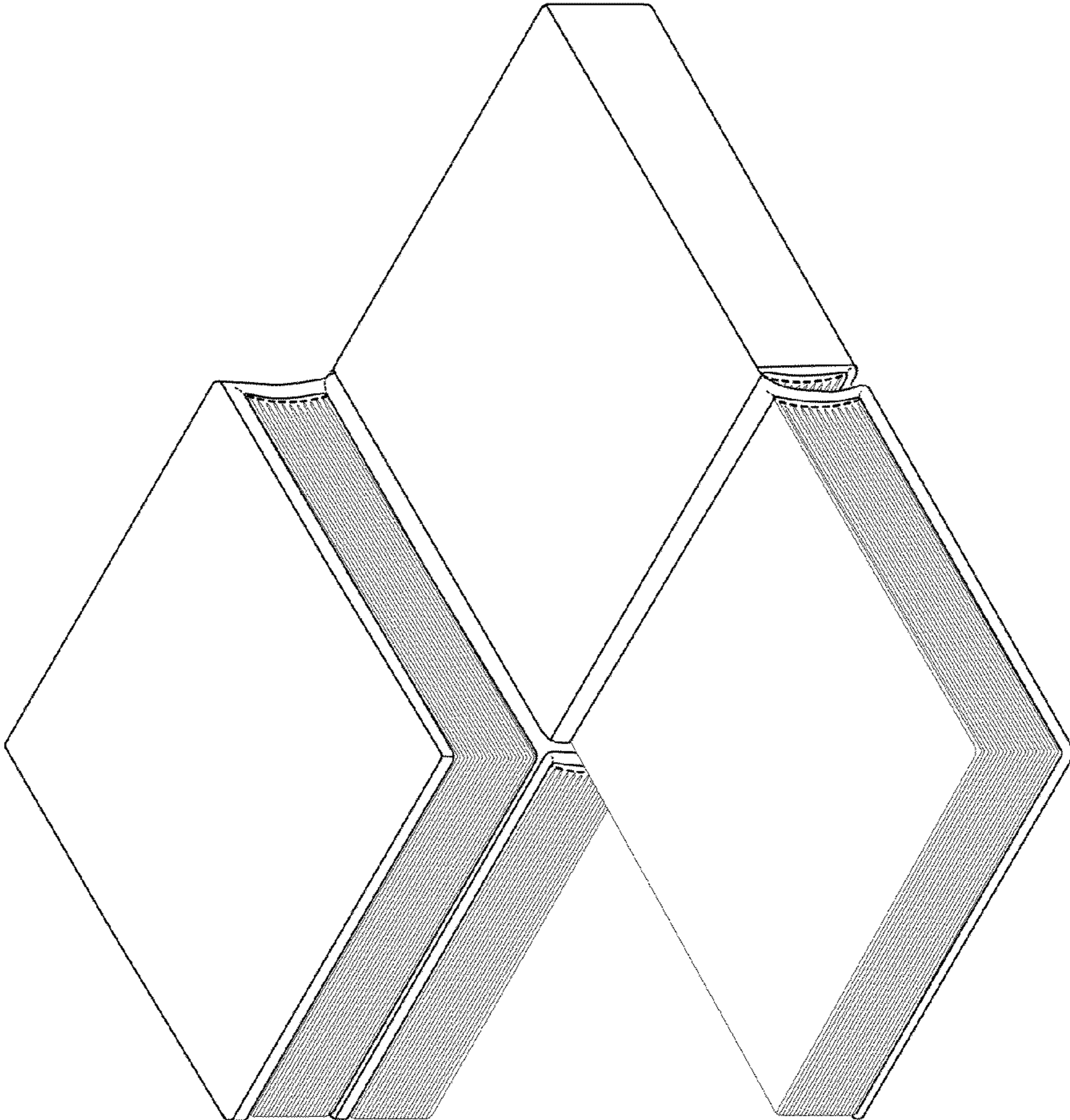

Fig. 12

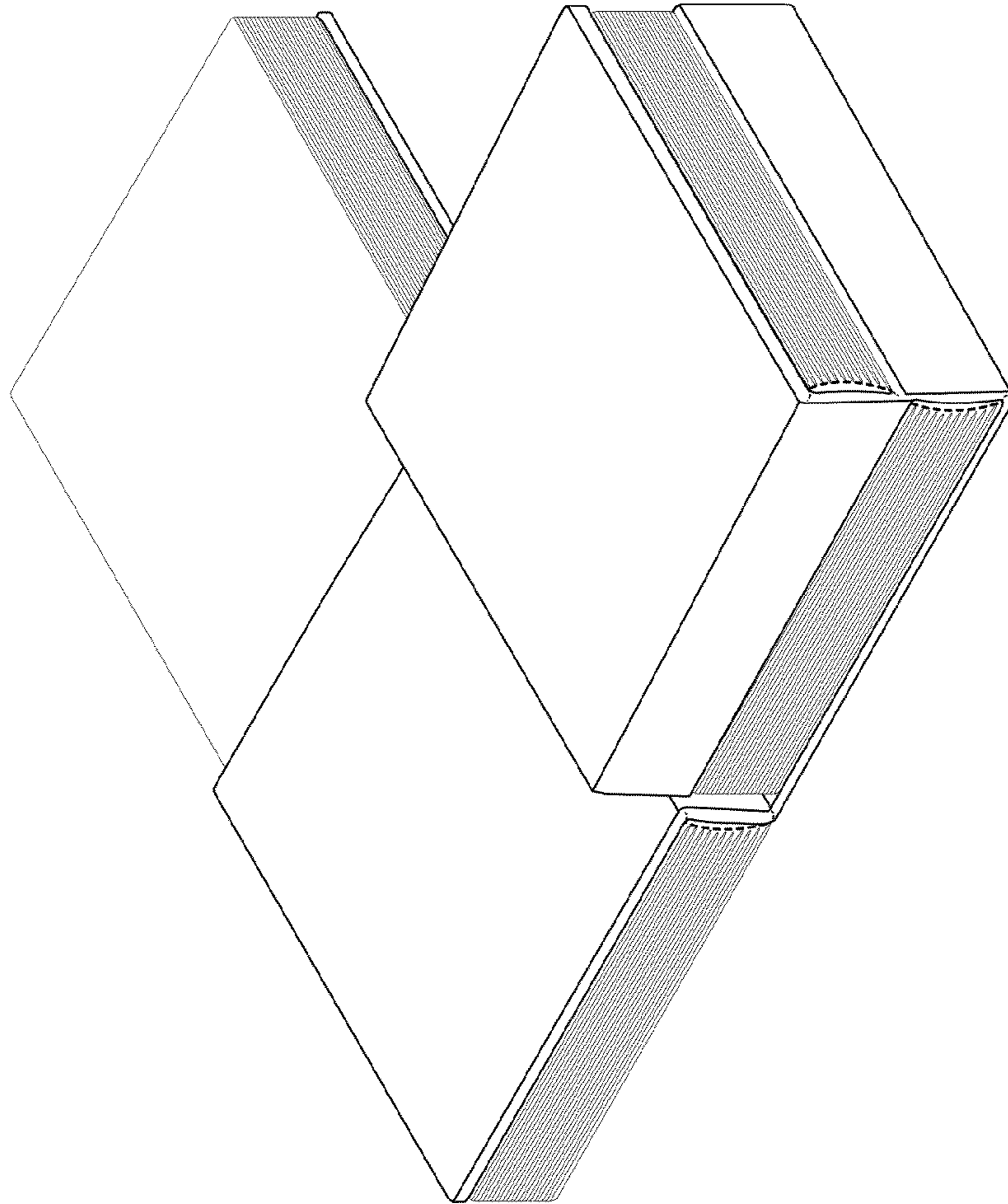

Fig. 13

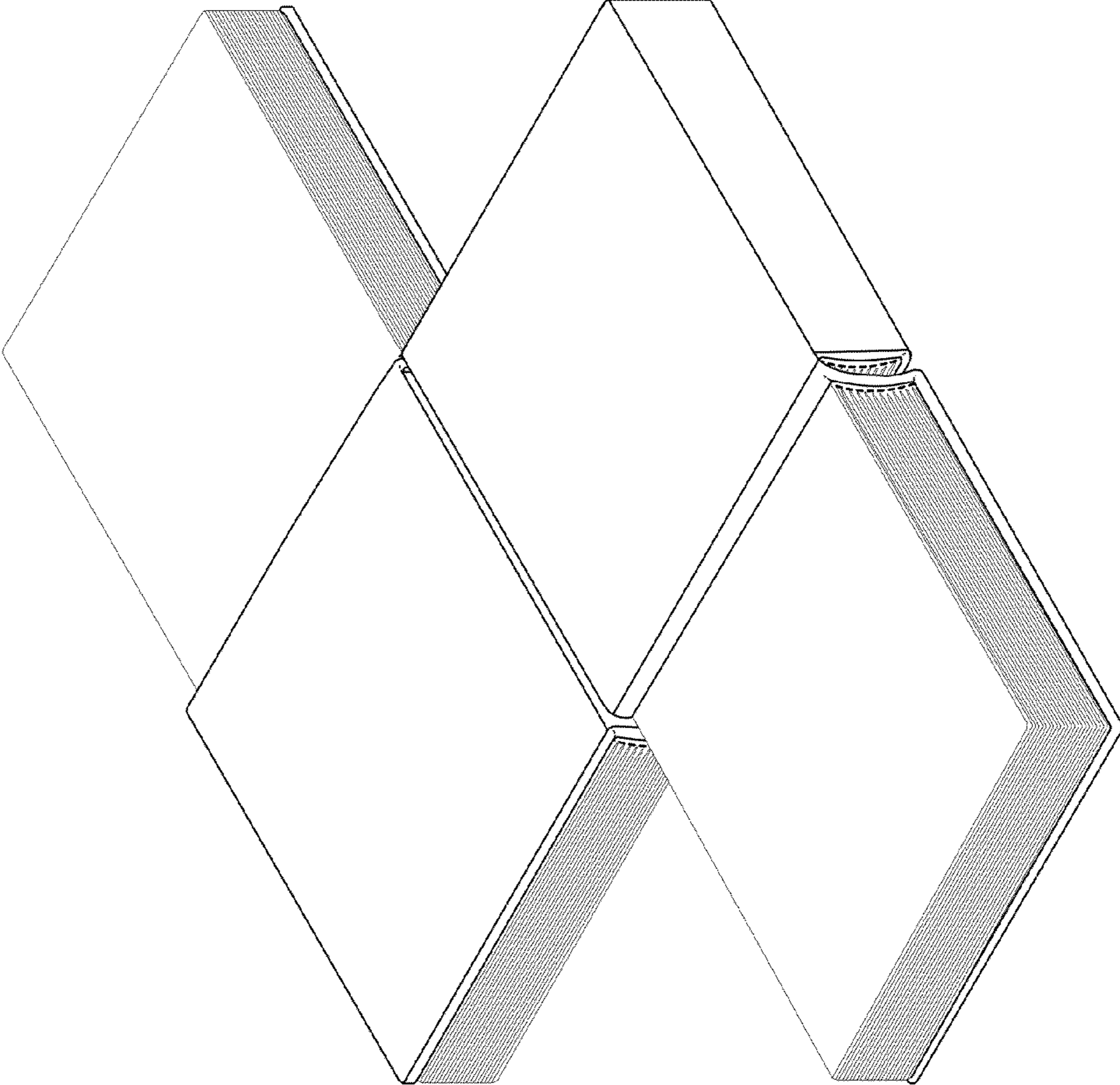

Fig. 14

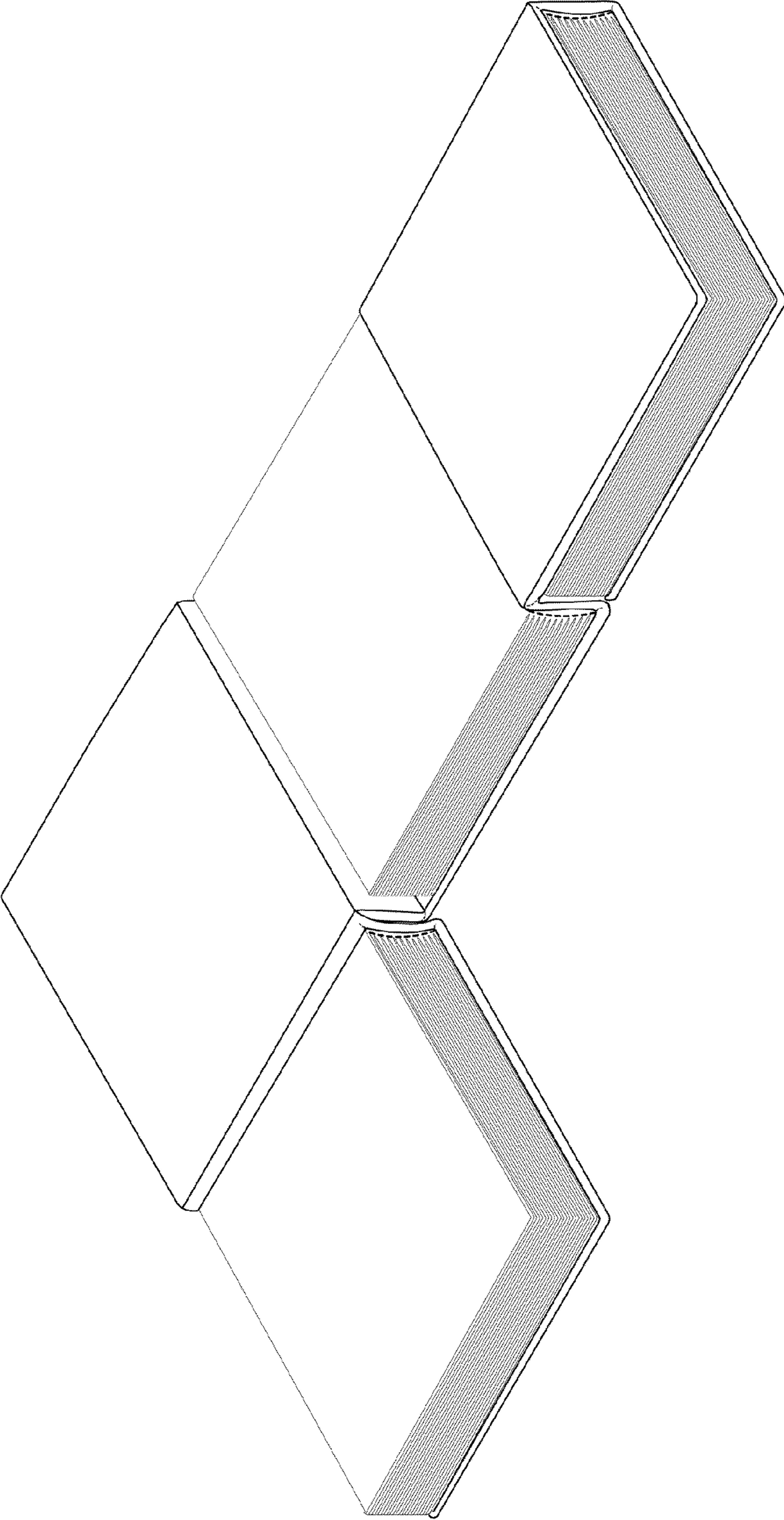

Fig. 15

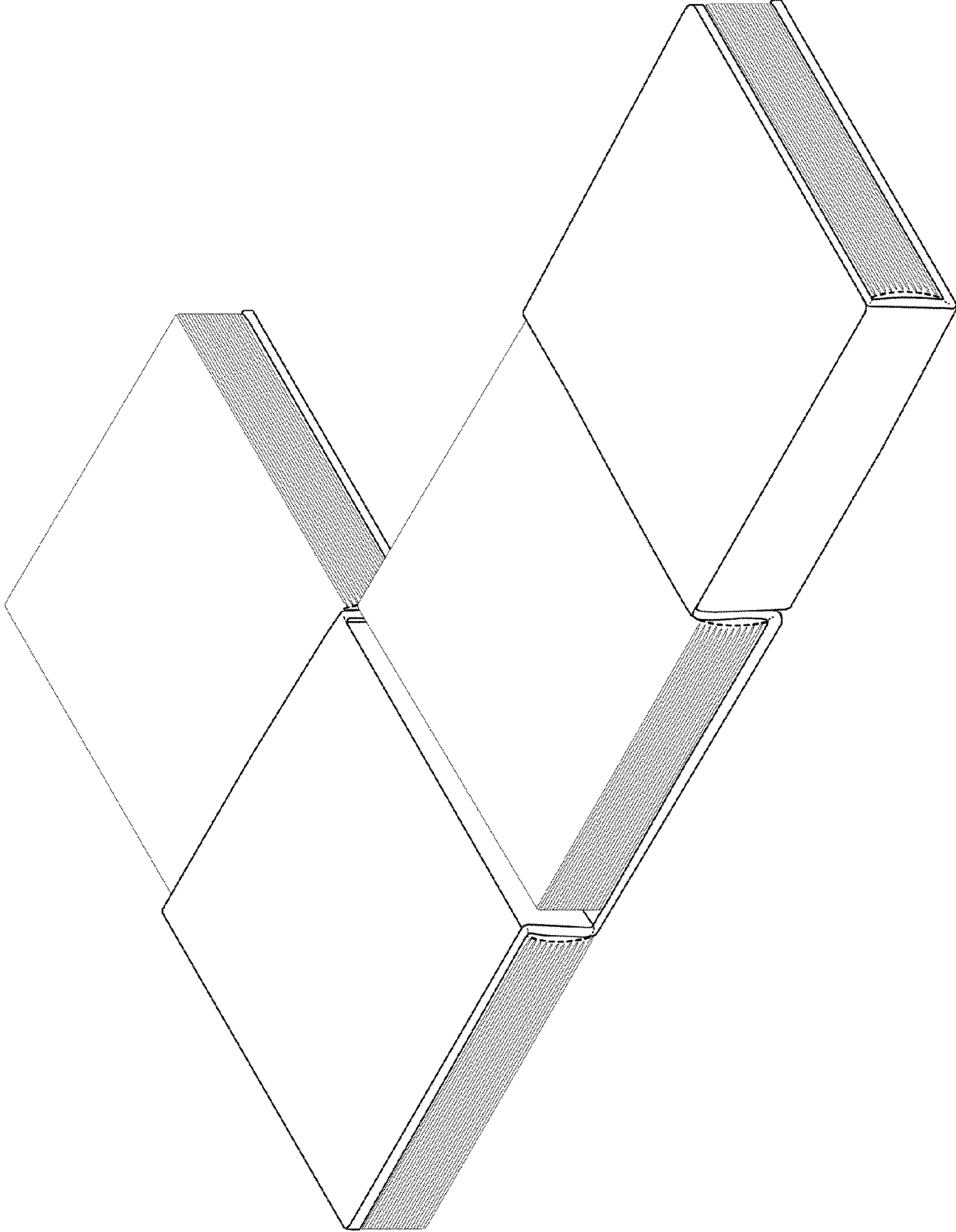

Fig. 16

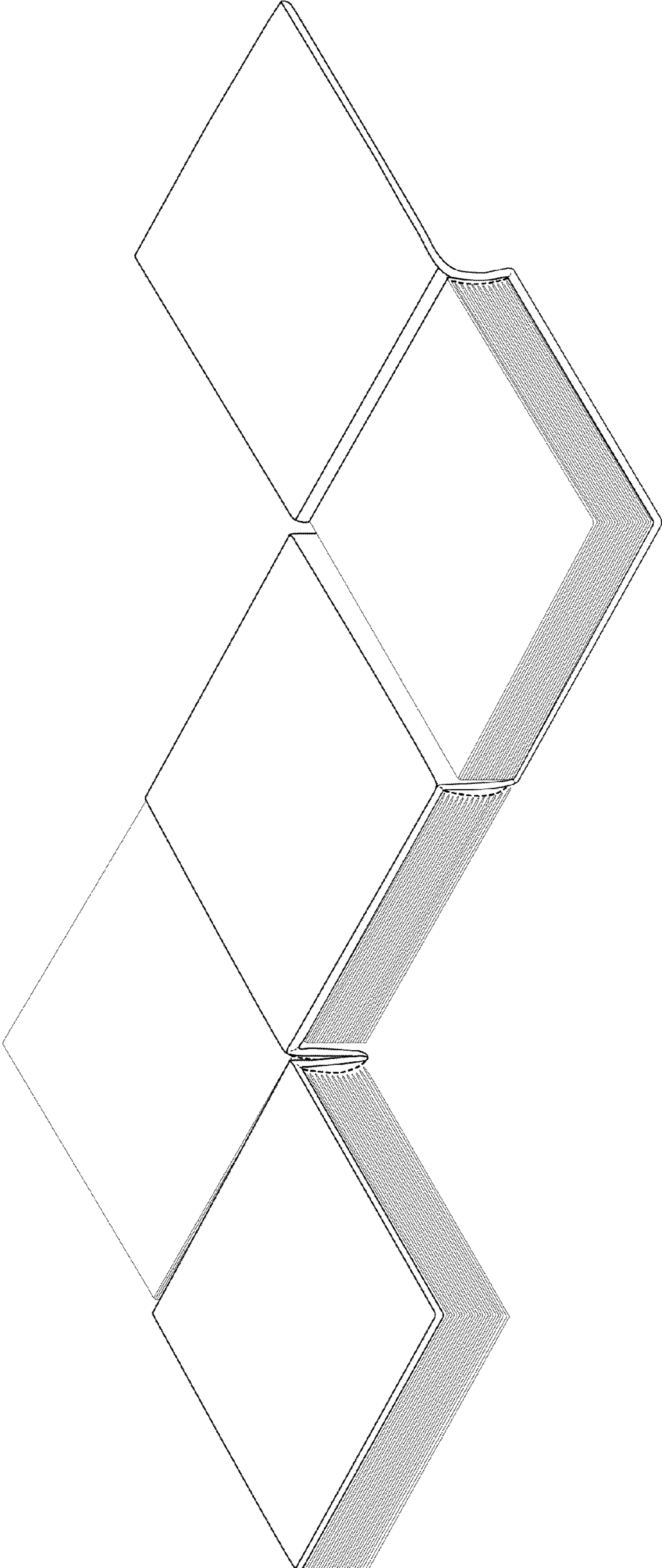

Fig. 17